

Please follow these fixing and care instructions to ensure your product is fitted safely and retains its high quality finish. Please retain the leaflet for future reference .

Fixing Pack Contents / Tools required

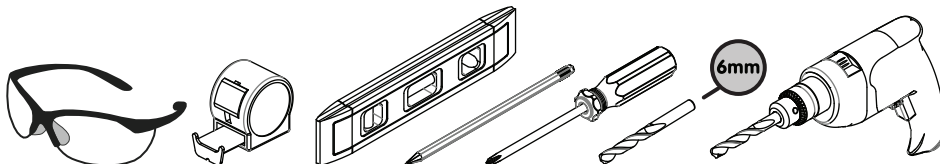
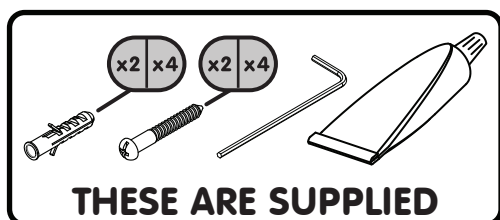

KEEP DIY TOOLS OUT OF THE REACH OF CHILDREN

Safety and Care Advice :

- Always take care when using power tools, particularly in the bathroom.
- Always check for hidden cables and pipework before drilling and take extreme care if there is any water in the working area.
- It is advisable to use a residual current circuit breaker (RCCB).
- Always wear suitable eye protection when drilling.
- If the product is to be fitted on a ceramic tiled wall, a ceramic drill bit should be used.
- Always ensure that the drill hole passes through the central tiled area rather than through the grouted area. To prevent damage to the tile, mask the area around the hole with tape before drilling.
- Do not strike the product with hard or sharp objects.
- Do not position glass products directly above a heat source.

Additional Information :

- Maximum safe working load for the shelf is 2kg evenly distributed.
- Wall brackets can be removed by twisting the bracket in an anti-clockwise direction.
- Adhesive residue can be removed by carefully scraping the wall surface with a blunt instrument.

Important Adhesive Information :

- The adhesive is suitable for use on most flat finished surfaces, such as gloss paint, tiles, polished stone, laminates and textured surfaces.
- Do not use on decorative wall paper finishes.
- Not suitable for unfinished materials such as brick, blockwork and loose, flaky surfaces.
- Redecoration may be required on some painted surfaces after removal.

Fitting Instructions for Flexi-Fix Wall Mounted Accessories

A WHEN USING EXISTING HOLES

1. Remove old wall plate.
(PLATE SHOWN FOR REF ONLY)

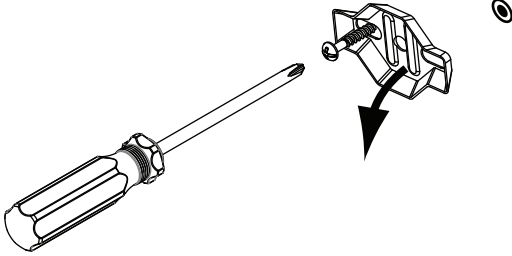

CAUTION!
ENSURE HOLES
IN THE WALL
ARE SUITABLE
FOR RE-USE

IT MAY BE
NECESSARY TO
DRILL NEW
HOLES

2. FLEXI FIX WALL PLATE WILL FIT
EXISTING HOLE CENTRES OF -
MAX - 34mm apart
MIN - 15mm apart

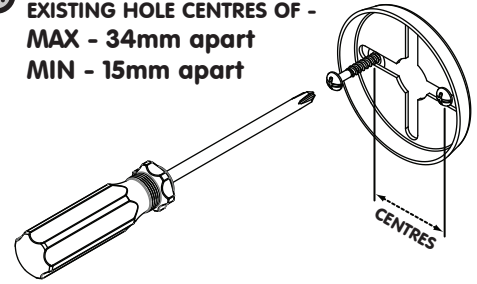

3. Secure product to Flexi Fix wall plate
by tightening the grub screw
underneath.

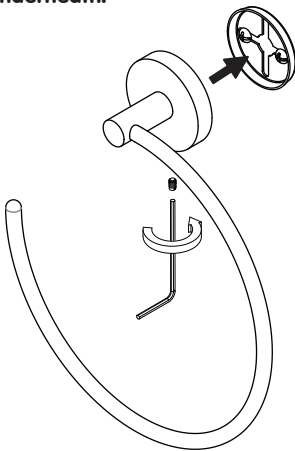

i Max Shelf Adjustment

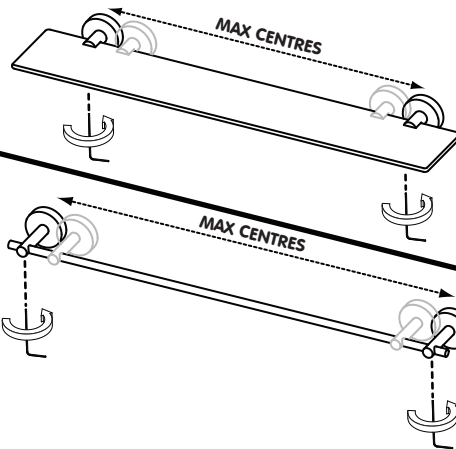

Max Towel Rail Adjustment

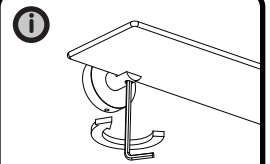

CAUTION!
SLIDE BRACKETS CAREFULLY
TO AVOID SCRATCHING
DO NOT OVERTIGHTEN

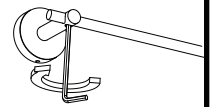

CAUTION!

When using existing holes **DO NOT EXCEED** the maximum bracket centre dimensions printed on the back of the shelf and towel rail packs. In some instances existing hole centres may be too far apart and not allow the brackets to be positioned as desired. In such instances please refer to the following instructions to drill new holes or use the adhesive fixing method.

Please refer to the following pages for fitting instructions when drilling new holes or using the adhesive fixing method.

B WHEN DRILLING NEW HOLES

1. Using a pencil mark the screw hole centres for the wall plates 30mm apart.

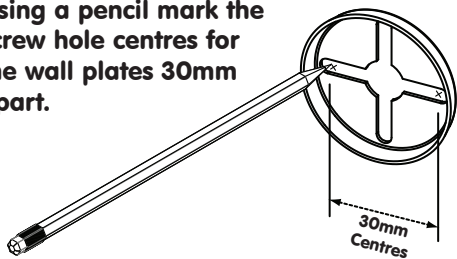

TIP!

To ensure the towel rail and shelf are horizontal, mark the wall using one wall plate and use a spirit level to find the position of the other using the recommended wall plate centre guides.



RECOMMENDED SHELF WALL PLATE CENTRES

440mm

CHECK

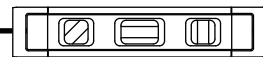

LEVEL

RECOMMENDED TOWEL RAIL WALL PLATE CENTRES

600mm

2. Drill holes

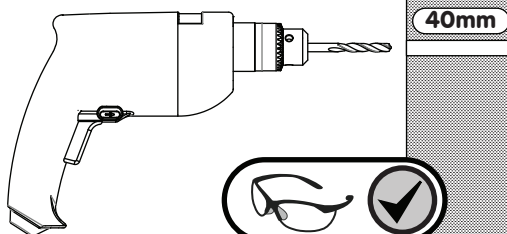

3. Insert wall plugs into the wall and fix the wall plates tightly into position using the screws supplied.

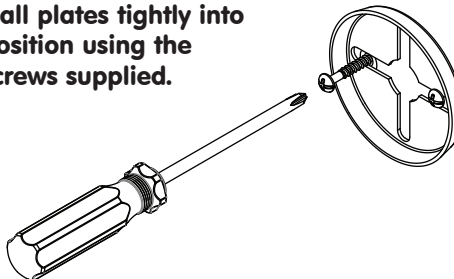

NOTE

Wall plugs supplied are suitable for a solid wall fixing only. For cavity walls or plasterboard use specialist fixings available from all good DIY stores.

4. Secure product to Flexi Fix wall plate by tightening the grub screw underneath.

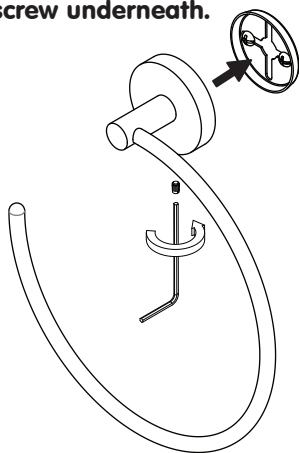

Shelf adjustment

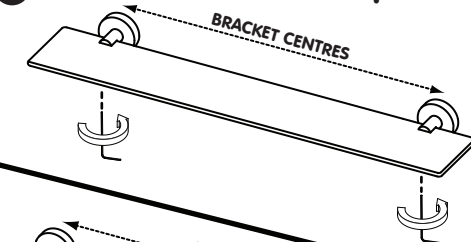

Towel rail adjustment

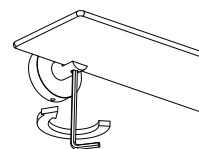

CAUTION!
SLIDE BRACKETS CAREFULLY TO AVOID SCRATCHING
DO NOT OVERTIGHTEN

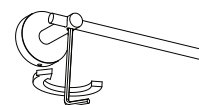

TIP!

To help line up and fix the towel rail and shelf brackets to the wall plates, loosen the grub screws on the underside of each pillar and adjust width as necessary.

C

WHEN USING ADHESIVE FIXING METHOD

(Please refer to Important Adhesive Information at the front of this leaflet before proceeding)

NOTE
BEFORE STARTING ENSURE ALL SURFACES ARE CLEAN AND FREE FROM DIRT AND SOAP RESIDUE PARTICULARLY IF ADHERING TO TILED WALLS

1 Assemble wall plate, alignment guide and locking nut as shown.

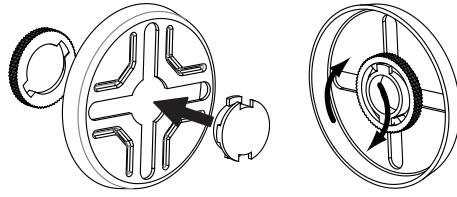

2 Remove backing from adhesive pad on alignment guide.

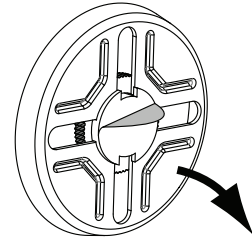

3 Place assembled wall plate in desired location and press firmly.

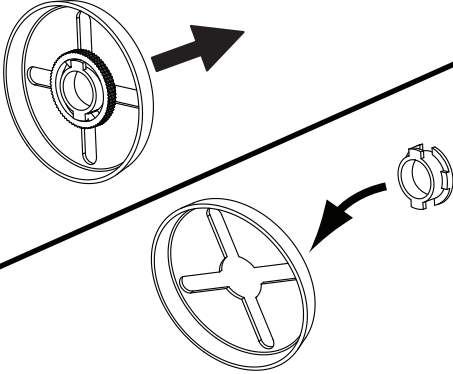

4 Undo locking nut and remove wall plate leaving alignment guide stuck to wall.

TIP!
To ensure the towel rail and shelf brackets are positioned accurately, use a spirit level to draw a horizontal line on the wall and mark the recommended wall plate centres on this line. Use these as a guide for positioning the wall plates.

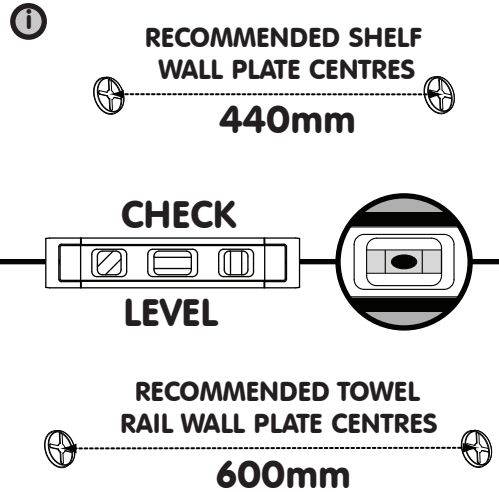

5 Apply a generous amount of adhesive to the back of the wall plate as shown. (each tube has enough adhesive for two wall plates)

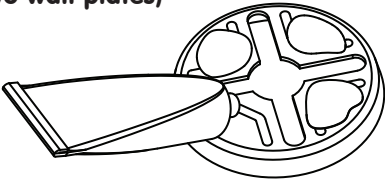

NOTE
Sufficient adhesive must be applied to give a uniform thickness of approximately 1.5mm when the wall plate is positioned against the wall.

6 Carefully place the wall plate over the alignment guide and allow the rotation of the locking nut to secure the wall plate in position. DO NOT PRESS IN POSITION. Leave the adhesive to set for 24 hours.

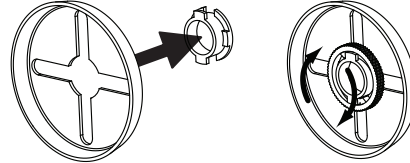

LEAVE 24 HOURS

7 When the adhesive is set, secure product to Flexi Fix wall plate by tightening the grub screw underneath.

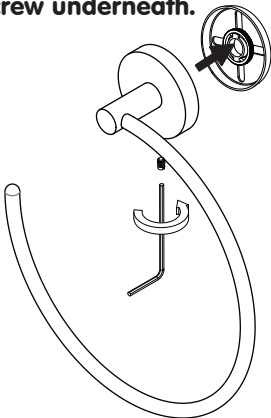

TIP!
To help line up and fix the towel rail and shelf brackets to the wall plates, loosen the grub screws on the underside of each pillar and adjust width as necessary.

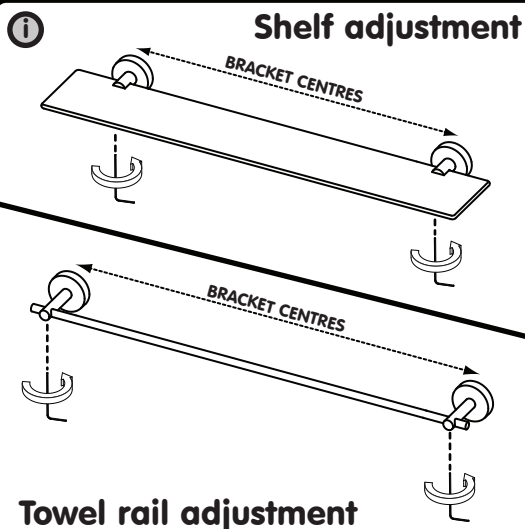

CAUTION!
SLIDE BRACKETS CAREFULLY TO AVOID SCRATCHING DO NOT OVERTIGHTEN

NOTE
If you require replacement adhesive please contact our customer services department quoting the batch code number on the adhesive tube.

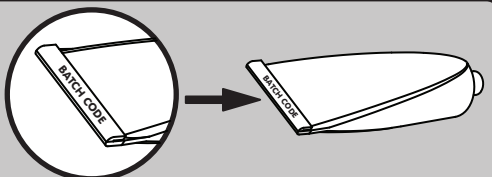

Croydex Ltd,
Central Way, Andover, Hants, SP10 5AW, UK
Tel: +44 (0) 1264 365881
Fax: +44 (0) 1264 356437
website: www.croydex.com
Email: info@croydex.co.uk