

INSTALLATION

Dear customer:

The product you have purchased has been engineered and manufactured to the highest standards of quality and performance. Please read the instruction sheet carefully before installing your new shade.

Get acquainted with your new shade

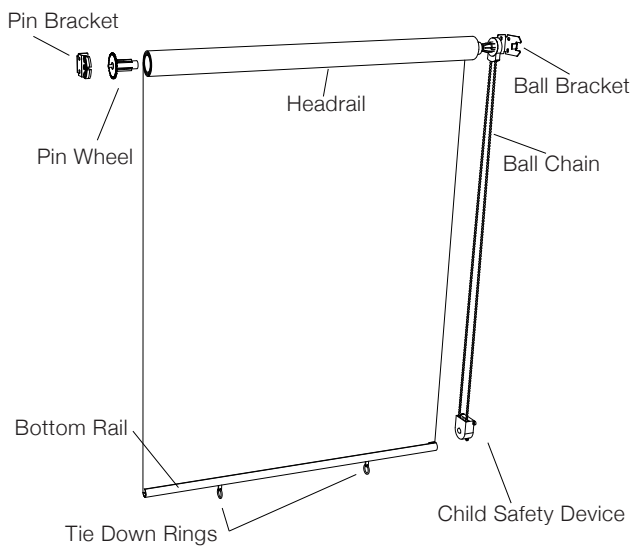

Hardware Contents:

1	1	1	1	7	7
1	2				

Tools Needed:

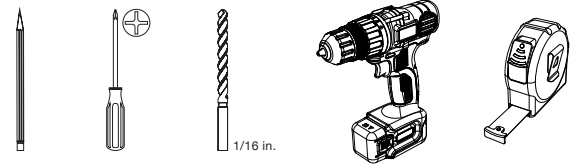

Step 1

Bracket location and installation

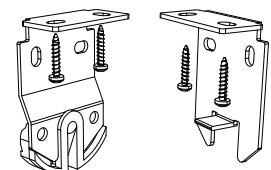
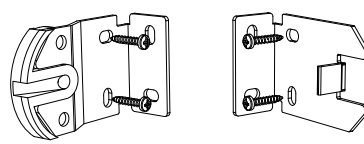
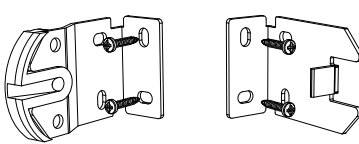
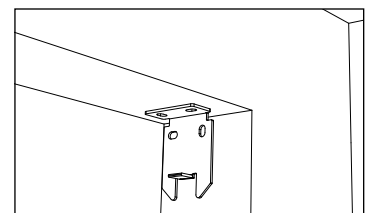
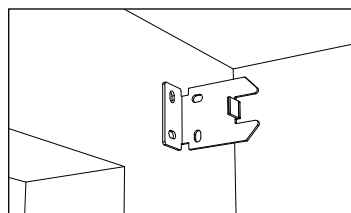
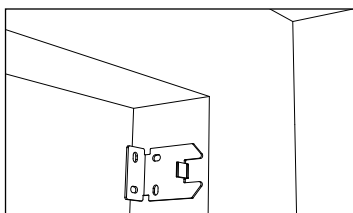

a). Inside
Mounting to the inside or between the sides of the window.

b). Outside
Mounting to the face or outside the window frame.

c). Top
Mounting overhead to a surface such as the top inside of the window frame or the ceiling.

Step 2

Measure where you want the shade to hang, make sure the blind is centered and level. Hold ball bracket at desired location and mark screw holes with a pencil. Drill pilot holes where you marked the screw holes. Use a screwdriver to attach the ball bracket with installation screws to the wall or window frame. Repeat for pin bracket at opposite end.

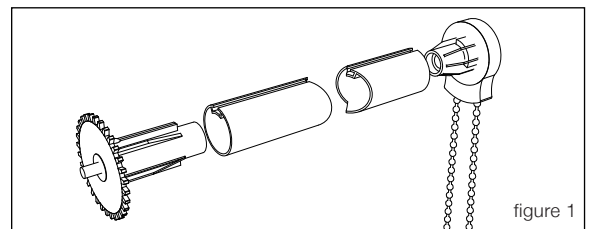

Step 3

Insert pin wheel and ball chain onto rod ends (figure 1).

Step 4

Pick up the shade and rotate the pin wheel to retract pin (figure 2). Place ball chain end of roller shade into ball bracket first. Hold the pin wheel end next to the pin bracket and rotate pin wheel to extrude pin into pin bracket and secure in place.

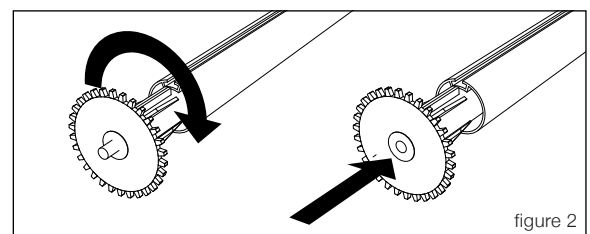

Step 5

Make sure ball chain is pulled tight (figure 3), use a screwdriver to attach safety device to wall or window frame.

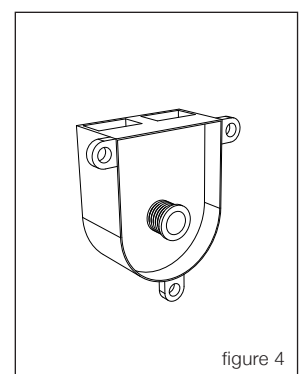
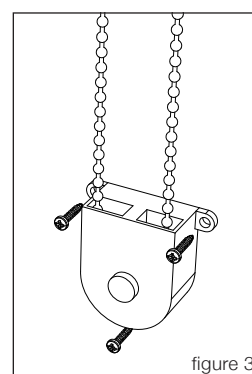

IMPORTANT:

The safety feature (figure 4) is designed to operate correctly when the back spring is fully secured to installation surface, (this ensures that all 3 installation screws are tightly secured). If the safety device becomes loose the shade will not operate.

Step 6

Wind Tie Down Rings (figure 5) allow the shade to be fastened down from the bottom rail. Secures shade in windy conditions.

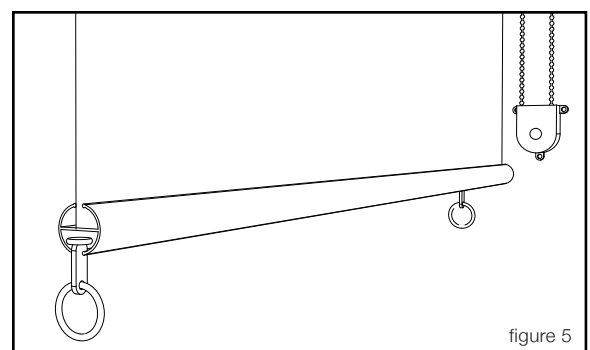

The cords on this product present a potential strangulation hazard.
Les câbles de ce produit représentent un danger potentiel de strangulation.
Los cordones de este producto representan un peligro potencial de estrangulamiento.