

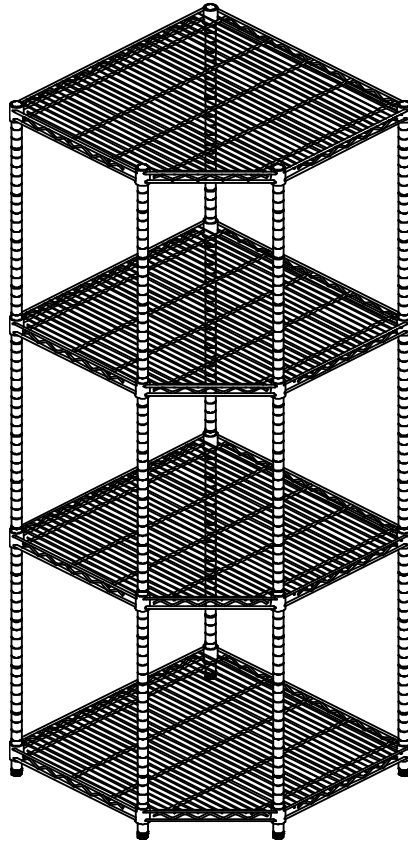

OWNER'S MANUAL



**TRINITY PRO 4-TIER NSF CORNER
WIRE SHELVING RACK
Model # TBFZ-0927 / TBFPBA-0927**



Important / Important / Importante

FOR QUICK & EASY 3D ASSEMBLY INSTRUCTIONS

POUR DES DIRECTIVES D'ASSEMBLAGE 3D RAPIDES ET FACILES

PARA INSTRUCCIONES DE ENSAMBLAJE RÁPIDAS Y SENCILLAS EN 3D

BILT.[®]

Intelligent Instructions
Directives intelligentes
Instrucciones Inteligentes



DOWNLOAD THE FREE APP | TÉLÉCHARGER L'APPLICATION GRATUITE | DESCARGUE LA APLICACIÓN GRATUITA

PARTS LIST

Your TRINITY PRO 4-Tier NSF Corner Wire Shelving Rack should include the following parts. Please inspect box contents to ensure you have received all components.

If you are missing any parts, need assistance with assembly or have questions, please contact TRINITY Customer Service: 800.985.5506 or customerservice@trinityii.com. Parts can also be requested online at www.trinityii.com (Help & More, Contact Us).

You will NOT need additional tools for assembly.

A

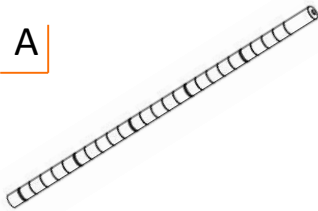

BOTTOM POLE (5)
Threaded Insert (5) and
Feet Leveler (5)
are pre-installed

B



MIDDLE POLE (5)
Pole Connector (5)
is pre-installed

C

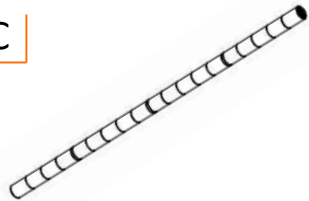

TOP POLE (5)
End Cap (5) and
Pole Connector (5)
are pre-installed

D



SHELF (4)

E



**SLIP SLEEVE
(40) + (2) extra**



Note: The black circular plastic spacers in between Shelves are used only for packaging purposes. They are NOT needed. Please discard.

ASSEMBLY INSTRUCTIONS

STEP 1

For easiest assembly, do not connect TOP POLES (C), MIDDLE POLES (B), and BOTTOM POLES (A) until instructed. Once connected, these will be posts for the Rack.

Note that each POLE (A+B+C) has slight horizontal line indentations at 1" intervals. Each SLIP SLEEVE (E) has raised horizontal lines inside designed to lock them in place on POLE (A+B+C).

On BOTTOM POLE (A), place 1 pair of SLIP SLEEVES (E) at desired height **no higher than 3rd** indentation from bottom. Please make sure arrow faces up and word "TOP" is right side up.

Slide pair of SLIP SLEEVES (E) until you hear a click to confirm the pair is locked onto BOTTOM POLE (A). Do this for each BOTTOM POLE (A) and make sure height is identical for each BOTTOM POLE (A). Do NOT place more than one pair on each BOTTOM POLE (A) at a time.

Note: There will be a very small gap in-between two locked SLIP SLEEVES (E)—this is normal.

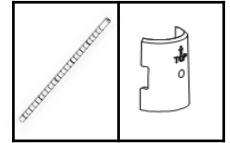

A (5)

E (10)

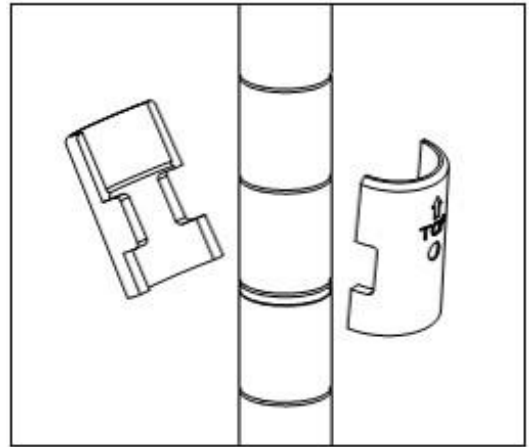

STEP 2

Place SHELF (D) on its side and slide each BOTTOM POLE (A) through each corner cylinder on SHELF (D). Make sure SHELF (D) corner cylinders are positioned over SLIP SLEEVES (E).

Stand the unit upright.

Note:

- *Level side of SHELF (D) is TOP side (TRINITY logo on corner cylinders should be right-side up.)*
- *Use a rubber mallet, if needed, to secure SHELF (D).*



D (1)

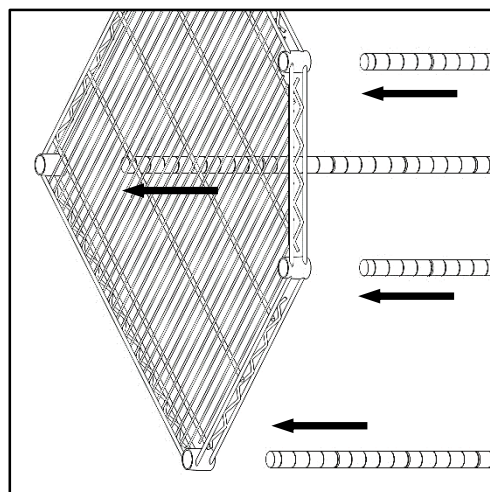

ASSEMBLY INSTRUCTIONS

STEP 3

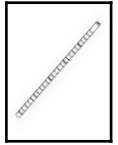

B (5)

Screw MIDDLE POLE (B) into BOTTOM POLE (A).

Repeat for each remaining MIDDLE POLE (B).

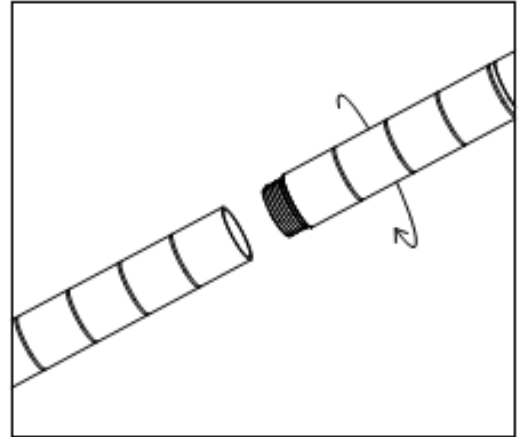

STEP 4

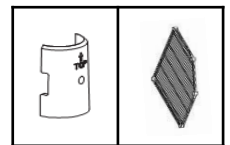

E (10)

D (1)

On POLE (A+B), place 1 pair of SLIP SLEEVES (E) at desired height between SHELVES (D). Please make sure arrow faces up and word "TOP" is right side up. Do this for each POLE (A+B) make sure height is identical for each POLE (A+B).

Lower SHELF (D) over each MIDDLE POLE (B) so corner cylinders of SHELF (D) are positioned over SLIP SLEEVES (E).

Note:

- Shelves are adjustable in 1" increments and can be placed as needed to best fit storage needs.
- Use a rubber mallet, if needed, to secure SHELF (D).

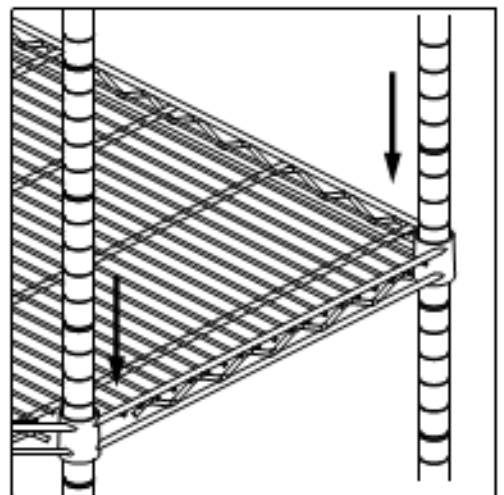

ASSEMBLY INSTRUCTIONS

STEP 5

Screw TOP POLE (C) into MIDDLE POLE (B).

Repeat for each remaining TOP POLE (C).

Note: Top of each TOP POLE (B) is indicated by a BLACK END CAP.



C (5)

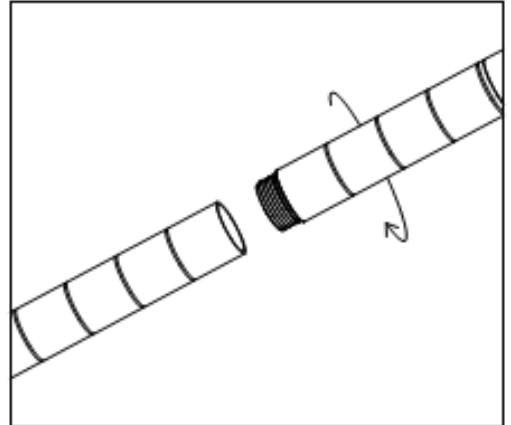

STEP 6

On POLE (A+B+C), place 1 pair of SLIP SLEEVES (E) at desired height between SHELVES (D). Please make sure arrow faces up and word "TOP" is right side up. Do this for each POLE (A+B+C) and make sure height is identical for each POLE (A+B+C).

Lower SHELF (D) over each TOP POLES (C) so corner cylinders of SHELF (D) are positioned over SLIP SLEEVES (E).

Note:

- Shelves are adjustable in 1" increments and can be placed as needed to best fit storage needs.
- Use a rubber mallet, if needed, to secure SHELF (D).

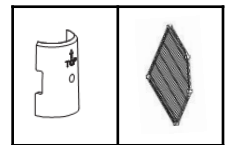

E (20)

D (2)

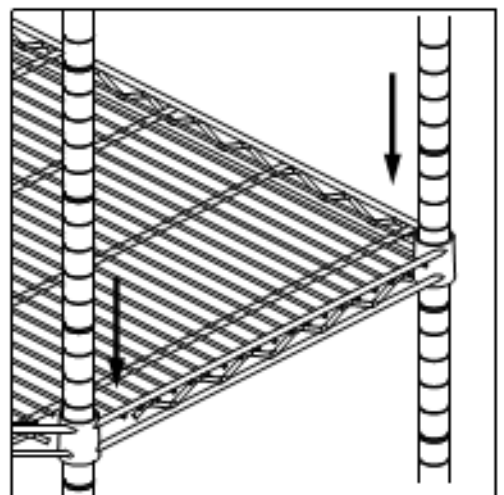

ASSEMBLY INSTRUCTIONS

STEP 7

Feet Levelers are already screwed into BOTTOM POLES (A).
Adjust as needed to ensure your shelving rack is level.

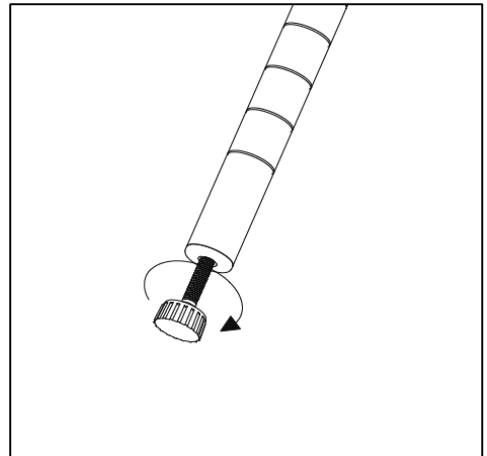

SERVICE PARTS LIST – TBFZ-0927 Chrome Color

TRINITY Customer Service provides the following replacement parts:

Part Number	Description	Part Number	Description
1) XBK-01-011-2543	Slip Sleeve	5) XBK-98-010-2535	Feet Leveler
2) ZSV-04-006-2475	Top Pole	6) ZSV-04-043-2700	Bottom Pole
3) ZSV-01-013-2523	Pole Connector	7) XBK-23-004-2517	End Cap
4) ZSV-04-007-2000	Middle Pole	8) ZSV-03-041-2718	Shelf

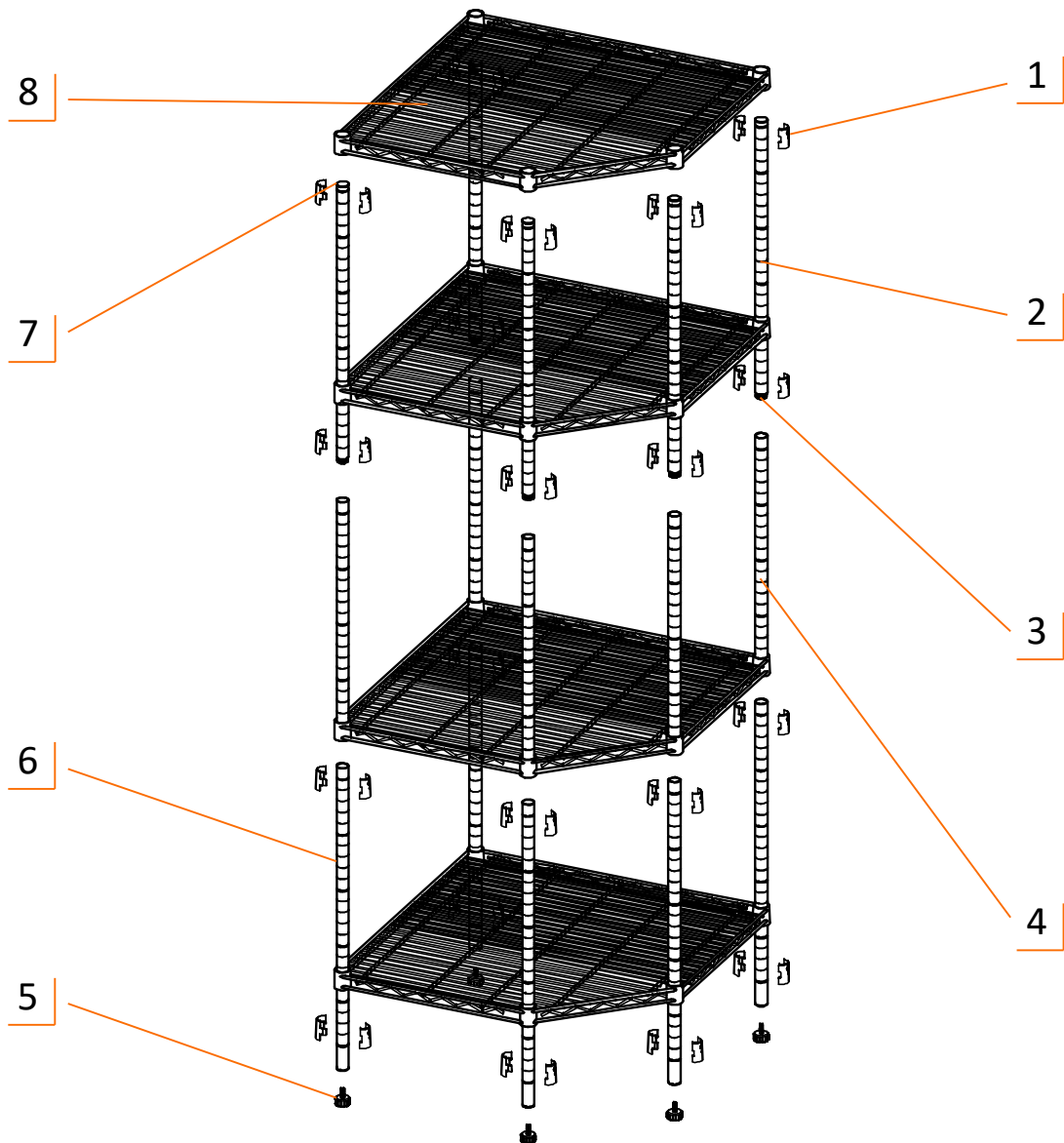

SERVICE PARTS LIST – TBFPA-0927 Black Anthracite Color

TRINITY Customer Service provides the following replacement parts:

	Part Number	Description		Part Number	Description
1)	XBK-01-012-2543	Slip Sleeve	5)	XBK-98-010-2535	Feet Leveler
2)	PBA-04-006-2475	Top Pole	6)	PBA-04-043-2700	Bottom Pole
3)	ZSV-01-013-2523	Pole Connector	7)	XBK-23-004-2517	End Cap
4)	PBA-04-007-2000	Middle Pole	8)	PBA-03-041-2718	Shelf

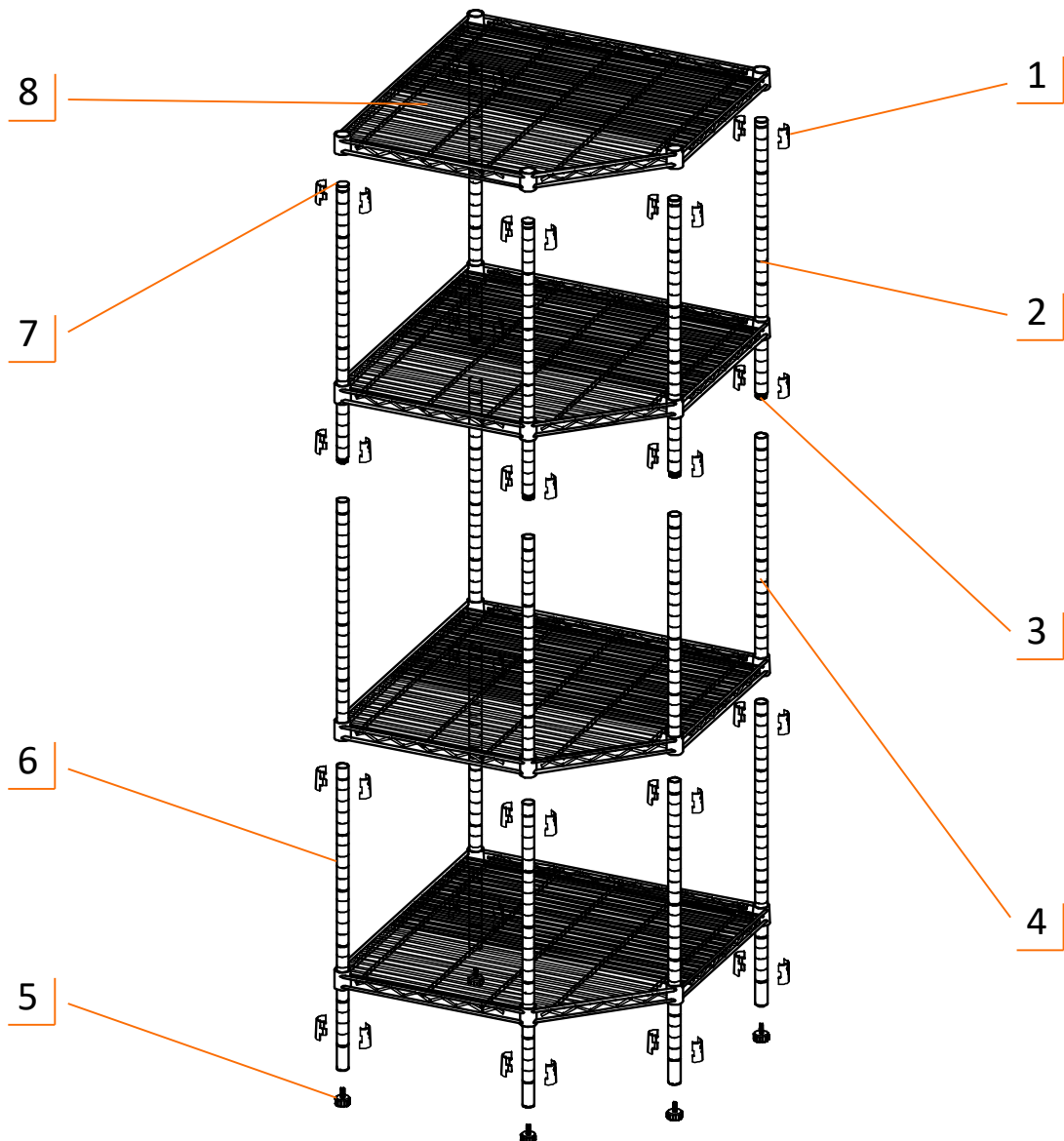

WARNINGS

1. **Read and understand all instructions.** Failure to follow all instructions may result in injury and/or damage.
2. **The warnings, cautions, and instructions discussed in this manual cannot cover all possible conditions or situations that may occur.** The user must always be aware of the environment where the product will be placed and make sure to use the product in a safe and responsible manner.
3. **Do NOT modify the product in any way.** Unauthorized modification may impair the function and/or safety of the product, and may affect the life of the product. Any modifications will void product warranty.
4. **Check for damaged parts.** Before using this product, carefully check that all parts are in good condition, and that the product will operate properly and perform its intended function. Check for damaged parts and any other conditions that may affect the operation of this product. Replace damaged or worn parts, and never use this product with a damaged part.
5. **Do NOT overload the product.**

Weight capacity per Shelf	800 lb (evenly distributed)
Total weight capacity of Shelving Rack	3200 lb (evenly distributed)

6. **Do NOT allow children to climb or play around the product.** Tipping may occur causing injury.
7. **Only use the product on an even and stable surface.**
8. **Load the product evenly and place the heaviest items on the lower shelves.**

CARE AND MAINTENANCE

- Wipe with a dry cloth as needed to remove dust and dirt.
- Avoid harsh, abrasive cleaners, and other corrosive chemicals.
- The zinc finish/chrome color product (TBFZ-0927) is not certified for outdoor use.

PRODUCT REGISTRATION

Thank you for purchasing a TRINITY PRO 4-Tier NSF Corner Wire Shelving Rack. In order to register your product and receive streamlined customer service, please fill out the following Product Registration Form and (1) fax the form to 310.347.4134 (2) complete the Product Registration Form online at www.trinityii.com or (3) scan and email the form to customerservice@trinityii.com. Include a copy of your original receipt with your submission.

First Name: _____ Last Name: _____

Address: _____

City: _____ State: _____ Zip Code: _____

Email Address: _____ Phone: _____

Product Model #: TBFZ-0927/TBFPBA-0927 Purchase Date: ____ / ____ / ____

Location of Purchase: _____

Please rate the importance of each feature (1=least important; 10=most important)

Quality ____ Price ____ Size/Capacity ____ Appearance ____ Other ____

How did you hear about our product?

- Magazine Ad Catalog Salesperson Word of Mouth
 Internet Store Display Other

Marital Status: Single Married

Household Income: Below \$50,000 \$50,000-\$150,000 \$150,000+

Education: High School College Graduate School

Primary Residence: Own Rent

Comments/Suggestions:



1 YEAR LIMITED WARRANTY

TRINITY PRO 4-Tier NSF Corner Wire Shelving Rack Model # TBFZ-0927 / TBFPA-0927

Trinity International Industries (“Trinity”) warrants to the original consumer purchaser (“Purchaser”) of the TRINITY PRO 4-Tier NSF Corner Wire Shelving Rack (“Product”) that each Product shall be free from defects in workmanship and materials for a period of 1 year from the date of original purchase. Trinity’s obligation under this warranty shall be limited to repair or replacement of, or adequate compensation for the Product which shall not be greater than the amount of the purchase price of the Product, at the option of Trinity, during the warranty period. All replaced parts and Products become the property of Trinity and must be returned to Trinity.

This warranty excludes normal wear and tear of the Product and its parts or components, and damage arising from any of the following: negligent use or misuse of the Product, use contrary to this User’s Manual, or alteration by any one other than Trinity. The warranty period of 1 year shall not be extended or renewed by the repair or replacement of, or compensation for, the Product. Any warranty implied by applicable law is limited in duration to one year from the date of purchase and is subject to the same conditions and limitations as is provided for our express warranty.

Except as set forth herein, and to the extent of applicable there are no warranties on this Product either express or implied, and Trinity disclaims all warranties including, but not limited to, any implied warranties of merchantability, infringement or fitness for a particular purpose. No warranty or guarantee given by any person, firm, or corporation with respect to this product shall be binding on Trinity.

If your Product is defective or otherwise requires service or parts, please call TRINITY Customer Service toll-free at (800) 985-5506, between 5:00 a.m. and 5:00 p.m., PST. Please tell us which model you purchased, the date of the purchase, and the problem with your Product. A copy of your original purchase receipt must accompany your service request.

LIMITATION OF REMEDIES AND LIABILITY

Trinity (and its employees, officers, members, managers, affiliates an assigns) shall not be liable for any incidental, consequential, special, indirect, remote, special or punitive damages for breach of any warranty, express or implied, including, but not limited to, lost profits, lost savings, loss of anticipated benefits and attorneys’ fees, which arise out of the purchase, use or inability to use the Product, whether arising out of contract, negligence, strict tort, product liability, or any other legal theory on which a claim is based. As noted above, to the extent damages are allowed by our express warranty or by applicable law, those damages may not exceed the purchase price paid for the Product. Without limiting the foregoing Purchaser assumes all risk and liability for loss, damage or injury to Purchaser and Purchaser’s property and to others and their property arising out of the use, misuse, or inability to use this Product. This limited warranty shall not extend to anyone other than the original purchaser of this product, is nontransferable and states your exclusive remedy.

Some states do not allow the exclusion or limitation of incidental, consequential, special, or punitive damages, so the above limitation or exclusion may not apply to you. The above warranty gives you specific legal rights, and you may have other rights which vary from state to state.

CONTACT US

**QUESTIONS? NEED PARTS?
WE ARE HERE TO HELP!**

Please feel free to contact us. There are no questions too small, or any problems too big. We're committed to providing our customers with the highest level of service.

TRINITY Customer Service

TEL: 800.985.5506

FAX: 310.347.4134

EMAIL: customerservice@trinityii.com

**Monday through Friday
5:00 AM – 5:00 PM (PST)**

www.trinityii.com