

Model: LV600HH

levoit
Hybrid Ultrasonic Humidifier

Questions or Concerns?

Please contact us Mon-Fri 9:00AM-5:00PM PST
at (888)726-8520 or email support@levoit.com



Thank You.

Thank you for purchasing the Hybrid Ultrasonic Humidifier by Levoit. We are dedicated to providing you with quality products so that you can see a better you. Should you have any questions or concerns about using your new product, feel free to reach out to our helpful Customer Support team at (888) 726-8520 or by email at support@levoit.com. We hope you enjoy your new product!



Table of Contents

Package Contents	2
Specifications	2
Safety Information	3
Main Functions	4
Set-Up	6
Operation	7
Cleaning & Maintenance	10
Troubleshooting	13
Warranty Information	15
Customer Support	17

Package Contents

1 x Hybrid Ultrasonic Humidifier
3 x Aroma Pads (1 pre-installed)
3 x Absorption Pads (1 pre-installed)
1 x Remote Control
1 x Cleaning Brush
1 x User Manual

Specifications

Power Supply:	AC 120V / 60Hz
Rated Power:	280W
Effective Range:	430–753 ft ² (40–70 m ²)
Water Tank Capacity:	1.5 gal. (6 L)
Max Cool Mist Capacity:	300 mL/h
Max Warm Mist Capacity:	500 mL/h



Safety Information

IMPORTANT: Please read, understand, and comply with all of the instructions provided in this manual before using the device. Failure to comply with the instructions given in this manual and/or using the device in ways other than the ones mentioned in this manual may result in serious injury and/or damage to the product.

- Ensure that the plug fits properly into a polarized power socket.
- Always disconnect from a power source by pulling the plug when not in use.
- **DO NOT** use this product in wet environments.
- **DO NOT** use your hand or any other object to cover the nozzle while the unit is on. Doing so may damage the product or cause injury.
- **DO NOT** clean the unit while it is connected to a power source or while it is on.
- Remove the water tank from the base before moving the humidifier.
- **DO NOT** clean the device right after turning it off, especially after it has been diffusing warm mist. Allow the humidifier to completely cool down before cleaning.
- **DO NOT** place the humidifier near sources of heat, such as stove tops, ovens, radiators or computers.
- **DO NOT** place the humidifier on the floor or in rooms with poor air circulation. It is recommended to place the humidifier on elevated level surfaces such as desktops, tables, or nightstands.
- **DO NOT** place the humidifier near any large pieces of furniture or in any high-traffic area where it can be easily knocked over.
- **DO NOT** direct the mist nozzle against the wall.
- Unplug the unit when not in use, or while cleaning it out.
- **DO NOT** use cleaning detergents to clean the humidifier; only use distilled white vinegar.
- **DO NOT** plug in the unit with wet hands.
- **DO NOT** place foreign objects into the unit's base or water tank. Do not use other items as replacement parts for this product.
- Keep the machine out of reach from children.
- Only use this humidifier as described in this manual.
- Contact Customer Support if the unit is damaged or if it is not functioning properly.



Main Functions

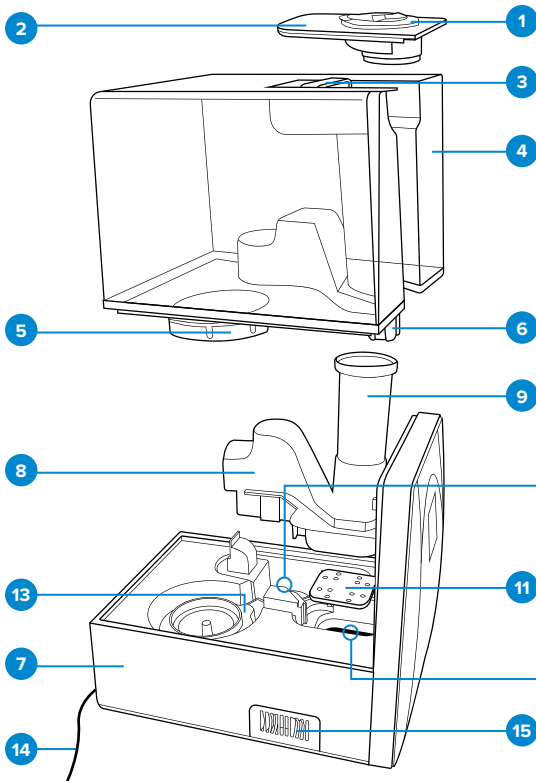

1. Nozzle
2. Handle Cover
3. Handle
4. Water Tank
5. Water Tank Cap
6. Water Level Sensor
7. Base
8. Air Flume
9. Mist Tube
10. Atomization Chip
11. Absorption Pad
12. Heating Element
13. Inner Chamber
14. Power Cord
15. Aroma Box

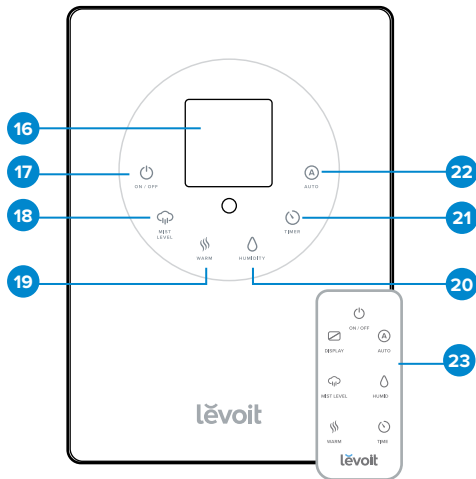

16. LED Display
17. On/Off Button
18. Mist Level Button
19. Warm Mist Button
20. Humidity Level Button
21. Timer Button
22. AUTO Button
23. Remote Control

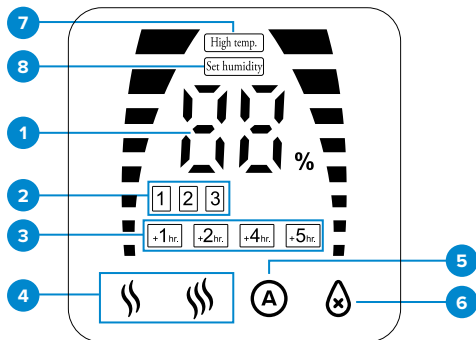

1. Relative Humidity (RH) Level Indicator
2. Cool Mist Humidity Level
3. Timer Setting
4. Warm Mist Humidity Level
5. AUTO Mode Indicator
6. Low Water Level Indicator
7. High Temperature Warning
8. Set Humidity Function



Set-Up

1. Place the humidifier on a table, desk, or other elevated surface. Do not place the humidifier directly on the floor or carpet, in corners or rooms with poor air circulation, or against walls where there is not enough clearance for the mist.

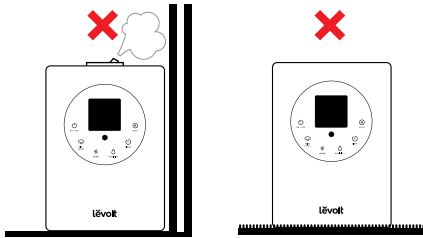

2. Remove the handle cover and set aside. Carefully lift the handle to remove water tank from the base.

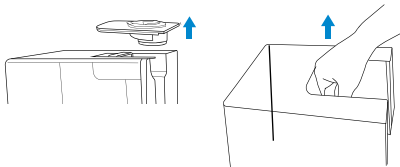

3. Flip the tank over and unscrew the water tank cap.

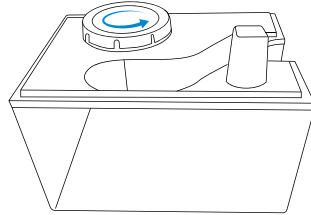

4. Fill the tank with filtered or purified water that is cold or room temperature. Replace the cap once you have filled the tank halfway or more.

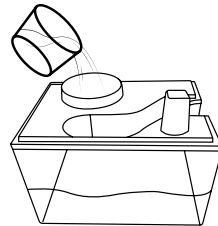

NOTE:

- The maximum capacity for the water tank is 1.5 gallons (6 liters).
- Before replacing the water tank cap, check if the sealing ring on the cap is properly installed.
- * Tap water may also be used, but the humidifier may need to be cleaned more often, as water with mineral content may result in white residue around the humidifier after use.

- Carefully place water tank back onto the base, making sure that the tank is properly aligned. Replace the handle cover.
- (OPTIONAL)** Remove the aroma box on the side of the humidifier and add several drops of essential oil to the aroma pad. Replace the aroma box after adding the essential oil.

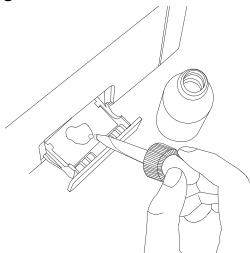

- Plug the humidifier into an electrical outlet. The unit will chime, indicating it is in standby mode.

NOTE:

- If the relative humidity exceeds 68%, turn off the humidifier or set it to the low mist setting. Excess humidity may have a negative effect on your health.
- It is recommended to adjust the settings on the humidifier based on your room's current relative humidity, room size, and indoor temperature.



Operation

Button Controls

NOTE: For added convenience, the same button controls can be found on the included remote control.



Turns on or turns off the humidifier.

Memory Function: The humidifier can remember its programmed settings before being turned off, though it must remain plugged in for the memory function to activate. If the unit is unplugged and plugged back in, the default mist will be cool mist level 2.



Press the **Mist Level button** to cycle through the 3 cool mist settings on the humidifier.

- Press once for mist level 1.
- Press twice for mist level 2.
- Press three times for mist level 3.

NOTE: The default setting when you first turn on the humidifier is cool mist level 2.



Use the **Humidity Level button** to program a humidity level for the humidifier.

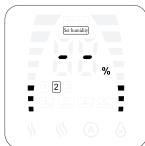

1. Press the Humidity Level button once to start programming. The display will read "--."



2. Keep pressing the Humidity Level button to select a custom humidity level between 40%-80% RH.

FLASH 5x

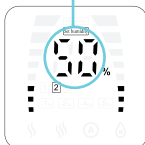

3. Once you have selected your desired humidity, the display will flash 5 times confirming your selection.

4. The device will start producing mist and automatically stop operating once the programmed humidity level has been reached.

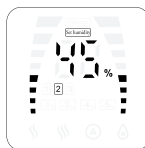

5. The device will resume operation when the relative humidity drops 5% below the set humidity value.

6. To exit out of the humidity level function, press and hold the Humidity Level button for 3 seconds.

NOTE:

- The programmed humidity level can be changed at any time by pressing the humidity level button.
- The "Set Humidity" icon will turn on while you are setting your humidity level and will turn off once your humidity level has been confirmed.
- Once you have programmed your humidity level, the display will alternate every 3 seconds between the programmed humidity and the current humidity level during operation.



Press the **Timer button** to set the timer anywhere from 1 to 12 hours. When you have selected your desired time, the display will flash three times before the time is set. The device will automatically turn off when the timer is finished counting down. To cancel or turn off the timer, keep pressing the Timer button until the display flashes "--."



Press the **Warm Mist button** to turn on the heating function on the humidifier. There are three heat settings to choose from:

Icon	Setting	Action
	Low heat. Warm Mist function has been turned on.	Press once.
	Medium heat.	Press a second time.
	High heat.	Press a third time.
None	Turn off Warm Mist function.	Press a fourth time.

NOTE:

- Use caution when setting the warm mist function; the mist being diffused will be hot.

Turning Off the Display

While the humidifier is operating, the display will automatically dim itself after 30 seconds. If you want to turn off the display, press and hold the AUTO button for 3 seconds or press "Display" button once on the remote control. To turn the display back on, press any button (except the power button) on the control panel.



Press the **AUTO button** to activate the automatic humidifying mode. The unit will automatically diffuse cool mist based on the surrounding environment and will maintain environmental humidity from 55-68% RH (the unit will run continuously if the humidity is below 54% RH and will stop when it reaches 68% RH). The table below shows the mist level in correlation to the relative humidity level for Auto Mode.

Relative Humidity	Mist Level
< 60% RH	Mist level 3
60%-63% RH	Mist level 2
64%-67% RH	Mist level 1
> 68%RH	Humidifier automatically shuts off.

NOTE:

- Changing the mist level while on AUTO mode will cancel the AUTO mode function.



The **Low Water Level Indicator** will appear on the display when more water needs to be added to the water tank. When this happens, the humidifier

will automatically shut off and will turn back on once a sufficient amount of water has been added.



Cleaning & Maintenance

Make sure the humidifier is disconnected from any power source before cleaning.

Cleaning the Humidifier

1. Unplug the humidifier. Allow the device and any remaining water to completely cool before cleaning.
2. Remove the water tank from the base and pour out any excess water. Pour out any remaining water from the water tank.
3. Remove the air flume and mist tube. Detach the mist tube from the air flume by twisting the tube counterclockwise. (see *figure.cm1*) Allow both parts to soak in vinegar for 30 minutes.
4. Remove the green absorption pad inside the heating element and rinse under clean water. Dry the pad with a clean, dry cloth.
5. Add 1 cup of distilled white vinegar to the inner chamber. Make sure there is vinegar on each section of the chamber including the atomization chip and heating element. Allow the vinegar to soak for 30 minutes. After 30 minutes, scrub all parts of the inner chamber with the included cleaning brush to remove any mineral buildup.

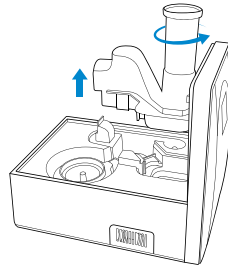
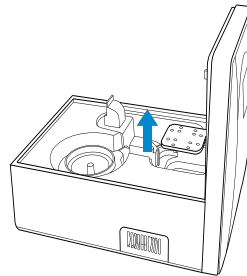
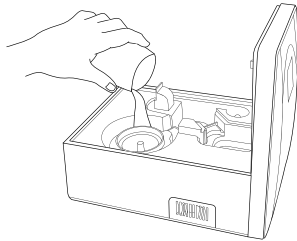

figure.cm1





6. While the inner chamber is soaking, fill the water tank half way with vinegar then reseal the tank. Gently shake the water tank to ensure all sides are evenly coated. Allow the tank to soak for 30 minutes. After 30 minutes, use a soft bristle brush (i.e., toothbrush or dish brush) to remove any mineral buildup inside the tank.
7. Pour out the excess vinegar from the water tank and base and rinse all components with cold water.
8. Allow all parts to completely dry before reassembling the humidifier.

Disinfecting the Humidifier

Disinfecting the humidifier removes any remaining bacteria or mold after cleaning both the water tank and base. It is recommended to disinfect your humidifier at least **once a week** with regular use as well as before and after storing for long periods of time.

1. Clean the base and water tank as instructed in the previous section.
2. Mix 1 teaspoon of bleach with 1 gallon of water.
3. Pour 1 cup of the solution into the inner chamber, and pour the rest into the water tank.
4. Allow the solution to soak for at least 30 minutes, but no longer than 1 hour.
5. Pour out the solution and rinse both water tank and base under cold water. Allow all parts to air dry before reassembling.

Tips for Regular Maintenance

- Disinfect your humidifier at least once a week if you are using it on a regular basis. This helps prevent any bacterial and mold growth that may occur.
- Always rinse out the water tank before each use. Changing the water each time you use the humidifier helps eliminate any bacteria that may have started to grow inside the tank.
- It is recommended to use distilled water with the humidifier. Tap water and hard water have a higher mineral content and can leave a white residue around the area where your humidifier is being used.
- Clean and drain the humidifier before storage to prevent bacterial and mold growth in your unit.

Cleaning the Aroma Pad

1. To clean the aroma pad, remove it from the aroma box and rinse under warm water.

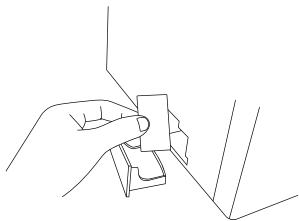

2. Dry the pad with a clean cloth and place it back into the aroma box.

NOTE:

• It is recommended to change the aroma pad every 6 months. You can purchase the items by searching for "Levoit Aroma Pads for LV600HH" on Amazon, or to purchase additional aroma pads, scan the QR code below.



Replacing the Remote Control Battery

1. Press the locking tab toward the pulling slot to remove the battery compartment.

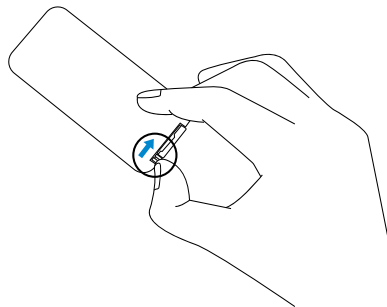

2. Properly dispose of the old battery.
3. Place a new 3V CR2025 battery into the battery compartment with the positive side facing up.



4. Replace the battery compartment into the remote.

NOTE: You can control the humidifier from up to The remote-controlled distance is 16 ft. (5 m).



Troubleshooting

Problem	Cause	Solution
No mist is being produced.	No water in the tank or water level is low.	Fill the water tank at least halfway full.
	The atomization chip or internal fan is not working.	Contact Customer Support.
Mist coming out from the base.	Water tank is not positioned correctly.	Properly align the water tank with the base.
High temperature warning on the display.	The heating element is running without any water in the humidifier.	Unplug the humidifier, add water to the water tank, and turn on the humidifier. Contact Customer Support if the high temperature warning still appears on the display.
Display is showing the incorrect humidity level.	The humidifier has been placed too close to a wall or in a corner causing the built-in humidity sensor to provide incorrect readings.	Move the humidifier away from walls or corners and place it in a well ventilated room.
	The humidity sensor has been exposed to dust.	Avoid using the humidifier in dusty environments. If necessary, clean dusty surfaces and areas before use.
There is a small amount white residue in the area where the humidifier is being used.	The water used in the humidifier had a high mineral content.	It is recommended to use filtered, purified, or distilled water.
	The humidifier needs to be cleaned.	Clean the humidifier as instructed in the Cleaning & Maintenance section.

Troubleshooting (cont.)

Problem	Cause	Solution
The surrounding area is damp after using the humidifier.	The humidifier has been placed directly on the floor or carpet.	Move the humidifier to a flat, elevated surface such as a table or desk.
	The ambient humidity is higher than 68%.	Turn off the humidifier, or set it to the lowest mist setting.
	The mist being produced is too close to the wall.	DO NOT direct the mist nozzle against the wall.
The display always shows 30% or 90% for the relative humidity while the unit is operating.	The humidity sensor is malfunctioning.	Contact Customer Support.
I cannot smell the essential oil that was added to the aroma pad.	A low-volatile oil has been used and does not easily evaporate.	Use a high-volatile (easily evaporated) oil for your humidifier.
The humidity level in the room has not changed, but the relative humidity indicator says the humidifier is working at full capacity.	The room is larger than the maximum effective range of the humidifier.	For best results, use the humidifier in a room that is less than or equal to 430–753 ft ² (40–70 m ²).
Water tank has to be refilled frequently.	The humidifier may be running at a high mist level.	Set the humidifier to run at a lower mist level to maximize the water in the water tank.
	The warm mist function is being used for an extended period of time.	Turn off the Warm Mist function and allow the heating element to cool for at least 30 minutes.
The humidifier diffuses warm mist while on the cool mist setting.	The heating element is still warm after being used for the warm mist.	Allow the heating element to cool for at least 30 minutes.



Warranty Information

TERMS & POLICY

Levoit warrants all products to be of the highest quality in material, craftsmanship, and service, effective starting from the date of purchase.

Levoit will replace any product found to be defective due to manufacturer flaws based on eligibility; refunds are available within the first 30 days of purchase. Refunds are only available to the original purchaser of the product. This warranty extends only to personal use and does not extend to any product that has been used for commercial, rental, or any other use in which the product is not intended for. There are no warranties other than the warranties expressly set forth with each product.

This warranty is non-transferrable. Levoit is not responsible in any way for any damages, losses or inconveniences caused by equipment failure or by user negligence, abuse, or use noncompliant with the user manual or any additional safety, use, or warnings included in the product packaging and manual.

This warranty does not apply to the following:

- Damage due to abuse, accident, alteration, misuse, tampering or vandalism.
- Improper or inadequate maintenance.
- Damage in return transit.
- Unsupervised use by children under 18 years of age.

Levoit and its subsidiaries assume no liability for damage caused by the use of the product other than for its intended use or as instructed in the user manual. Some states do not allow this exclusion or limitation of incidental or consequential losses so the foregoing disclaimer may not apply to you. This warranty gives you specific legal rights and you may also have other rights which may vary from state to state.

ALL EXPRESSED AND IMPLIED WARRANTIES, INCLUDING THE WARRANTY OF MERCHANTABILITY, ARE LIMITED TO THE PERIOD OF THE LIMITED WARRANTY.

Additional 1-Year Warranty

You can extend your one-year warranty by an additional year. Log onto www.levoit.com/ warranty and enter your order number (i.e. Amazon or Houzz) within the first 14 days of purchase to register your new product for the extended warranty.

Warranty Information (cont.)

If you are unable to provide the order number for your product, please type a short note in the order number field along with the date you received your product.

Defective Products & Returns

Should your product prove defective within the specified warranty period, please contact Customer Support via support@levoit.com with your invoice and order number. Once our Customer Support team has approved your request, please return the unit with a copy of your invoice and order number.

Product Name	Hybrid Ultra Sonic Humidifier
Model Number	LV600HH
Default Warranty Period	1 Year
<i>For your own reference, we strongly recommend that you record your order number and date of purchase.</i>	
Date of Purchase	
Order Number	



Customer Support

Should you encounter any issues or have any questions regarding your new product, feel free to contact our helpful Customer Support Team.

We're here for you.

Levoit Corporation

1202 N. Miller Street, Suite A
Anaheim, CA 92806

Toll-Free: 888.726.8520
Email: support@levoit.com

Support Hours
Monday - Friday: 9:00am - 5:00pm PST

**Please have your order number ready
before contacting customer support.*

lěvoit

www.levoit.com