

Yorkshire 31 in Single Bathroom Vanity with Carrera Marble Top

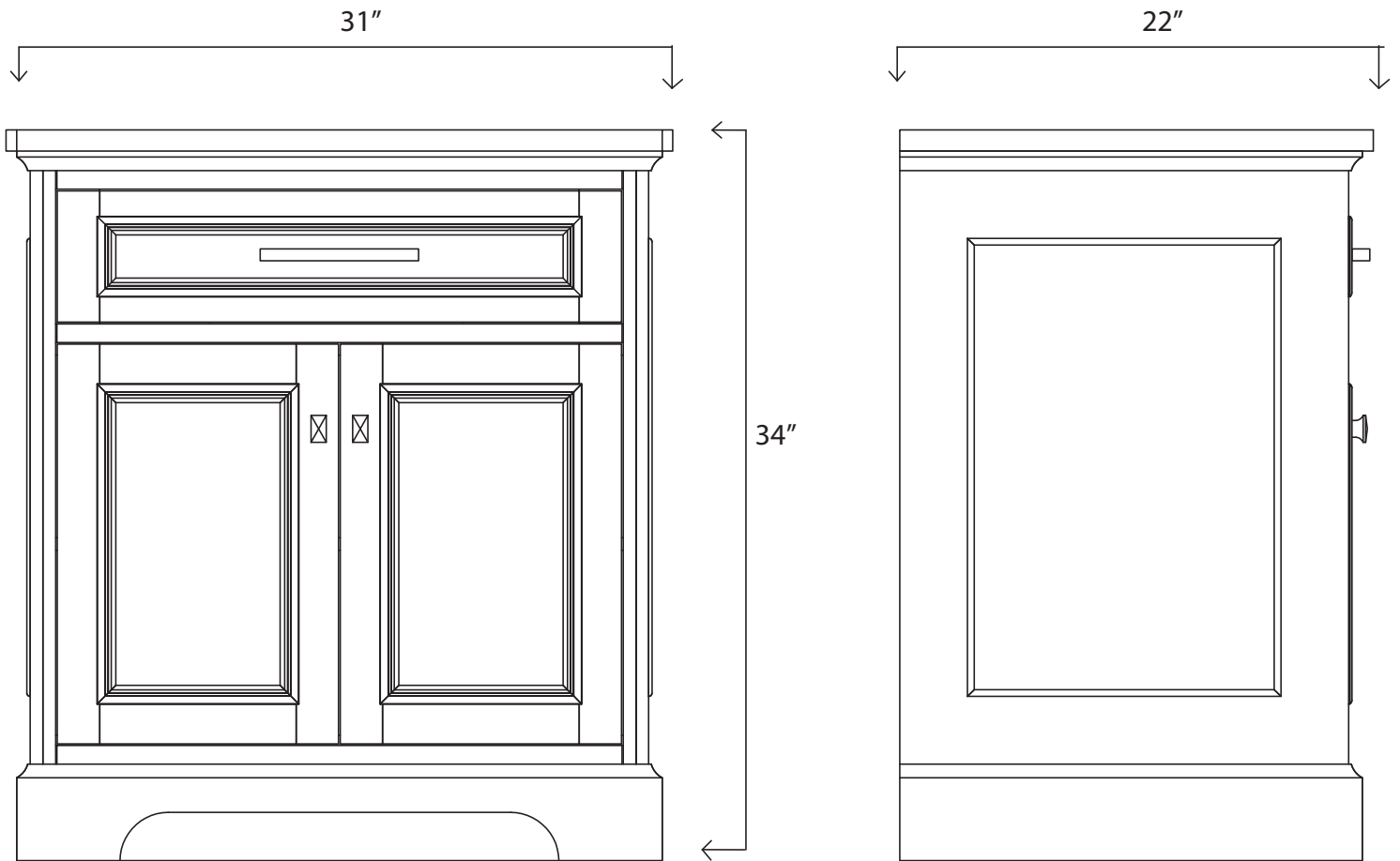

BACK SPLASH INSTALLATION

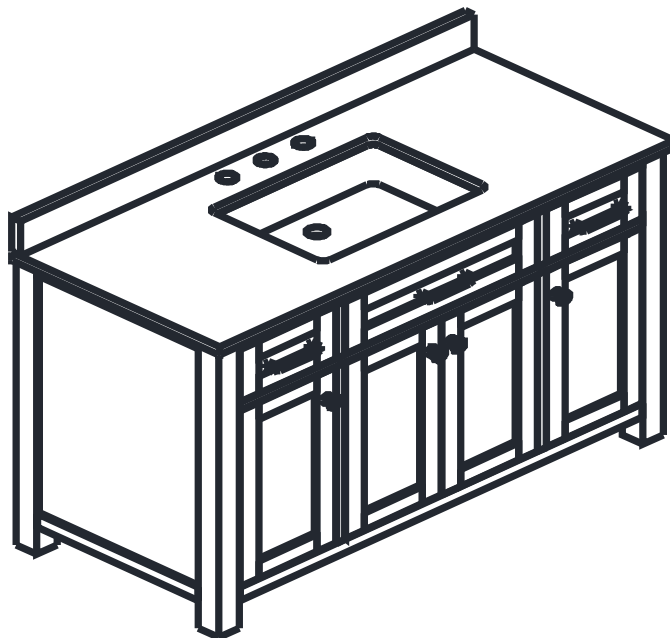

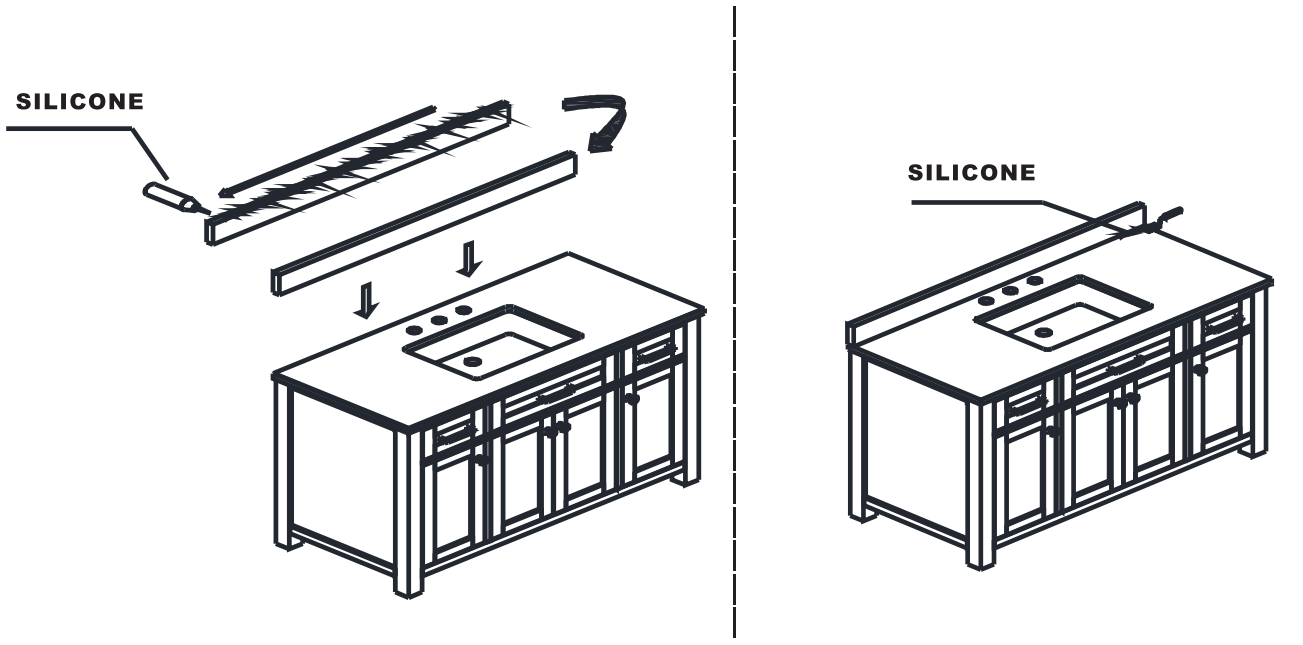
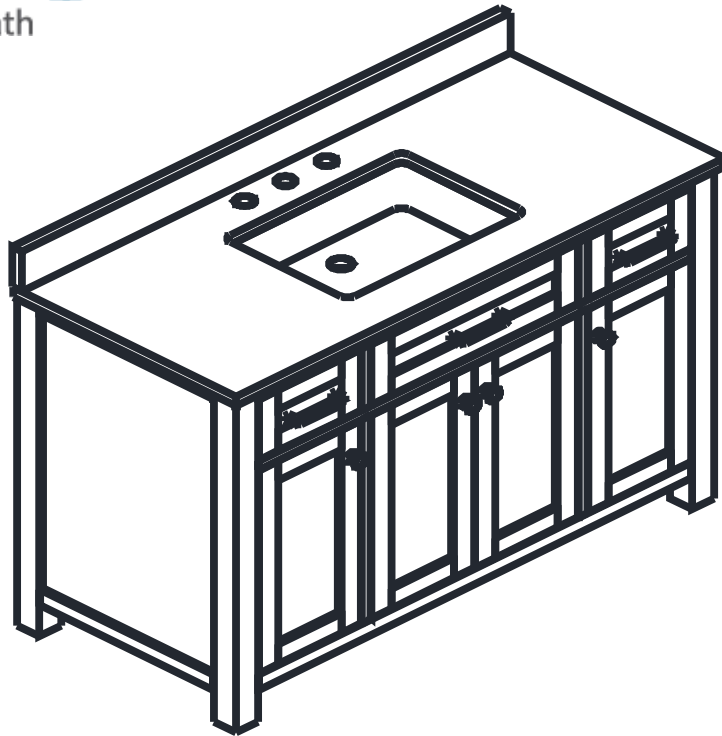

***THE SKETCH IS FOR INSTALLATION ONLY,IT MAY NOT MATCH TO THE PRODUCTS INSIDE THE CARTON.**

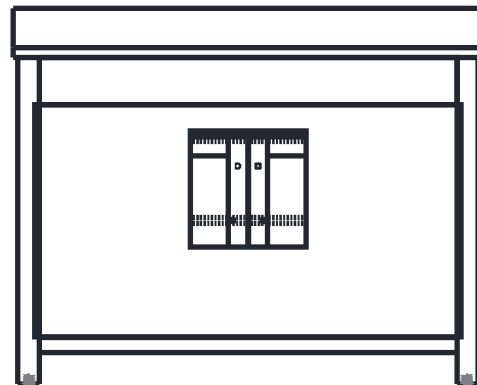
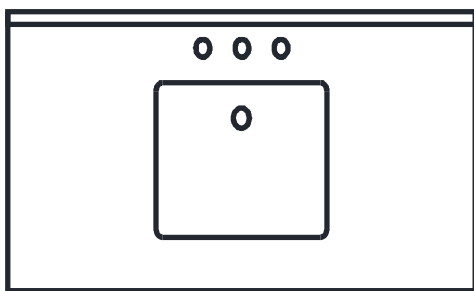



Installation Manual

- .carefully read the instructions before starting the installation.**
- .This vanity should be installed by an experienced plumber.**
- .Drain pipe and drain trap are not supplied. Connect to an existing drain pipe.**

MIRROR INSTALLATION

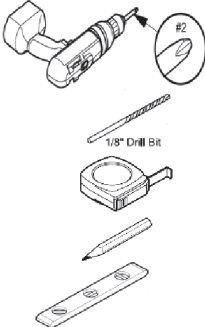
*THE SKETCH IS FOR INSTALLATION ONLY,IT MAY NOT MATCH TO THE PRODUCTS INSIDE THE CARTON.

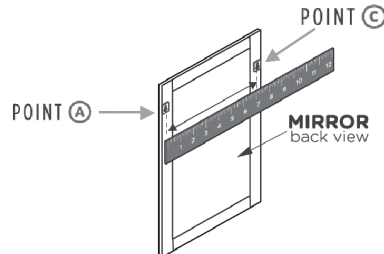
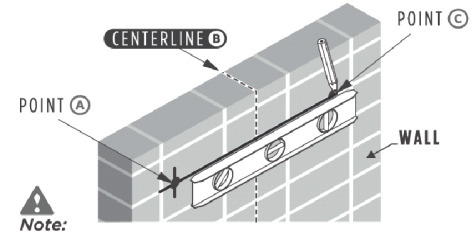
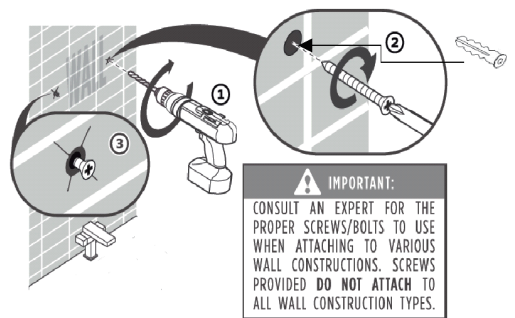
Tools for Assembly (Not Included)	Supplies (Included in Package)
 <p>Electric Drill with #2 Drill Bit</p> <p>1/8" Drill Bit</p> <p>Tape Measure</p> <p>Builder's Pencil</p> <p>Level</p>	 <p>Wall Anchor (2pcs)</p> <p>Screw (2pcs)</p>
<p>1.</p>	<p>2.</p>
<p>Flip the mirror over and measure the distance between point A and C.</p> 	<p>Mark the measured distance between point A to point C on the wall by using a level.</p>  <p>Note: The distance from A + B should be equal to B + C.</p>
<p>3.</p>	<p>4.</p>
<p>Once position is marked, drill 2 holes and insert the wall anchors and screws.</p>  <p>IMPORTANT: CONSULT AN EXPERT FOR THE PROPER SCREWS/BOLTS TO USE WHEN ATTACHING TO VARIOUS WALL CONSTRUCTIONS. SCREWS PROVIDED DO NOT ATTACH TO ALL WALL CONSTRUCTION TYPES.</p>	<p>Hang mirror on the wall.</p> 