

JKD3000DN/SN

GE® 27" Built-In Double Electric Wall Oven

DIMENSIONS AND INSTALLATION INFORMATION

NOTE: Wall coverings, countertops and cabinets surrounding the wall oven must be able to withstand a temperature of up to 200°F (94°C).

NOTE: If the cabinet in which the wall oven is installed does not have a solid bottom, two braces or runners must be installed to support the weight of the oven. The runners and braces must support up to 400 lbs (181 kg).

NOTE: Door handle protrudes 3" from door face. Cabinets and drawers on adjacent 45° and 90° walls should be placed to avoid interference with the handle.

ATTENTION INSTALLER: Electric wall ovens are NOT approved for installation with a plug and receptacle. They must be hard wired into an approved junction box.

IMPORTANT: Before installing, consult installation instructions packed with product for current dimensional data.

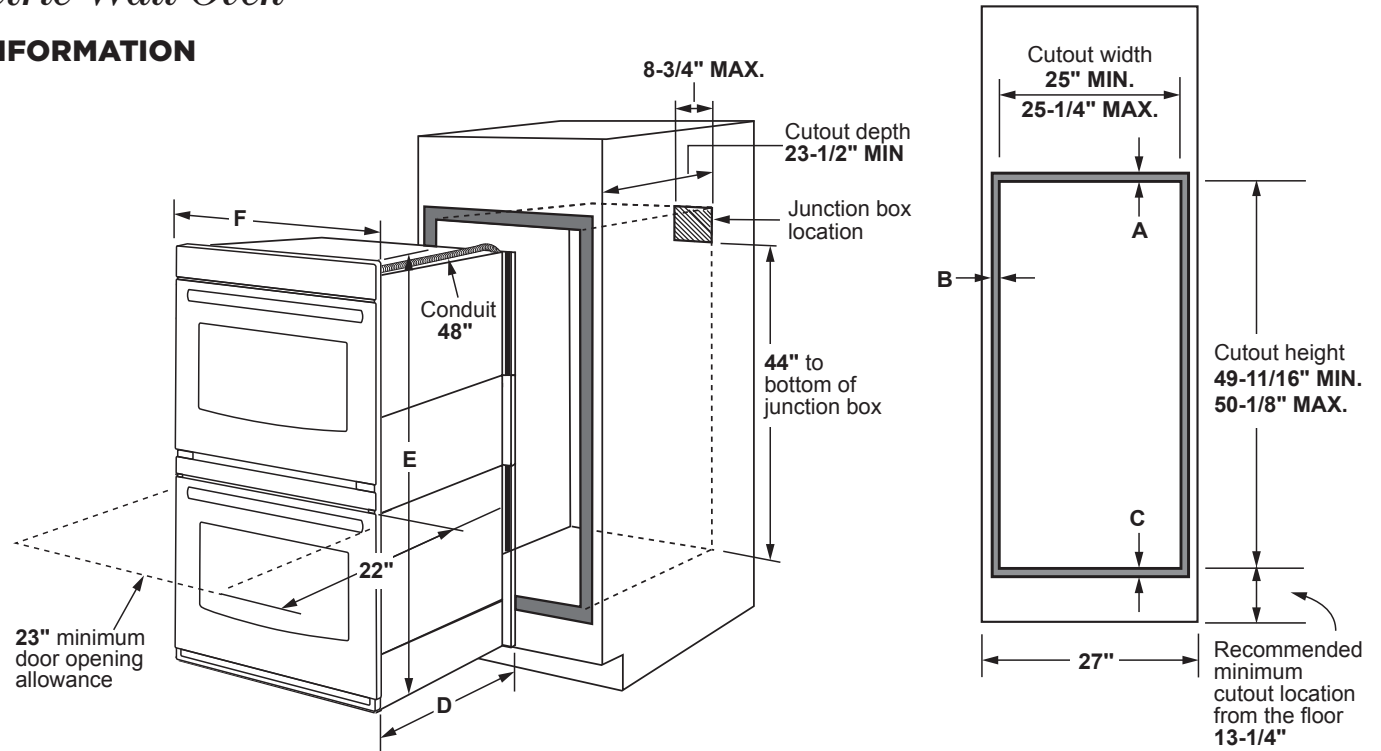

Dimension and installation information are shown in inches.

KW RATING	
240V	8.4
208V	6.3
BREAKER SIZE	
240V	40 Amps
208V	40 Amps

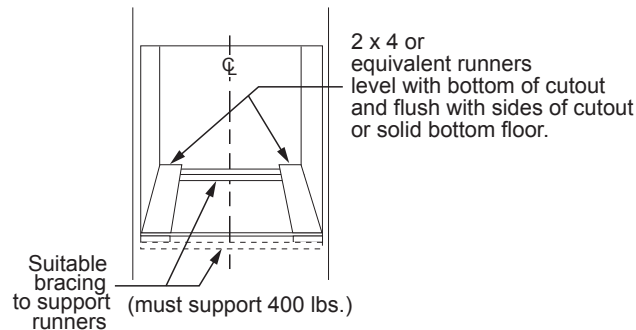

JKD3000

Cabinet	27"
A - Overlap of oven at top of cutout	1"
B - Overlap of oven other side of edge of cutout	1"
C - Overlap of oven at bottom of cutout	1"
Oven	
D - Install depth	23-1/2"
E - Overall height with trim	51-1/8"
F - Overall width	26-3/4"



For answers to your GE Profile™ Series or GE Appliances product questions, visit our website at geappliances.com or call GE Answer Center® Service, 800.626.2000.



Listed by Underwriters Laboratories



JKD3000DN/SN

GE® 27" Built-In Double Electric Wall Oven

FEATURES AND BENEFITS

Never scrub, heavy-duty racks – Say goodbye to scrubbing thanks to never scrub heavy-duty racks, engineered to withstand a self clean cycle

Self-Clean with optional Steam Clean – Cleaning the oven interior has never been easier, with two cleaning options to fit your lifestyle

Anywhere control with remote notifications – Save time by conveniently preheating and monitoring your oven from anywhere using the GE Appliances Kitchen app

Scan-to-cook – Prepare your favorite packaged foods to perfection simply by scanning the barcode on the package with your smartphone and letting your oven adjust settings automatically

Glass touch controls – Set temperatures quickly and clean with little effort

10-pass hidden bake element – Even baking and quick cleanup are assured, with 10-pass element that heats a large cooking area and is hidden for an easy-to-wipe surface

8-pass broil element – Get full broil coverage and even browning from edge to edge

Model JKD3000DNBB – Black

Model JKD3000DNWW – White

Model JKD3000SNSS – Stainless steel

FIT GUARANTEE

Replacing a similar wall oven from GE Appliances or another brand? GE wall ovens are guaranteed for an exact fit or GE Appliances will pay up to \$300 toward modifications.

Visit geappliances.com for more info

