

# USE AND CARE GUIDE

---

## 2 LIGHT OUTDOOR POST LANTERN

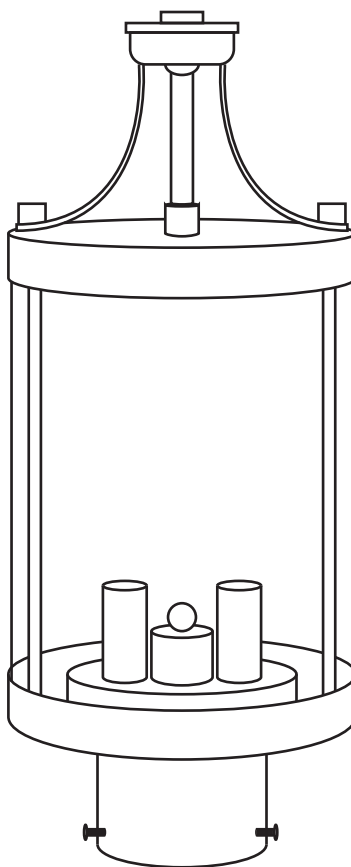

Questions, problems, missing parts? Before returning to the store,  
call Home Decorators Collection Customer Service.  
8 a.m. - 7 p.m., EST, Monday-Friday, 9 a.m. - 6 p.m., EST, Saturday

**1-800-986-3460**

**[HOMEDEPOT.COM/HOMEDECORATORS](http://HOMEDEPOT.COM/HOMEDECORATORS)**

---

### THANK YOU

We appreciate the trust and confidence you have placed in Home Decorators Collection through the purchase of this light fixture. We strive to continually create quality products designed to enhance your home. Visit us online to see our full line of products available for your home improvement needs. Thank you for choosing Home Decorators Collection!

# Table of Contents

Table of Contents.....	2	Hardware Included.....	3
Safety Information.....	2	Package Contents.....	4
Warranty.....	2	Installation .....	5
Pre-Installation .....	3	Operation .....	6
Planning Installation.....	3	Care and Cleaning .....	6
Tools Required.....	3	Troubleshooting.....	6

# Safety Information

- Consult a qualified electrician if you have any electrical questions.

 **CAUTION:** Inspect the wire insulation for any cuts, abrasions, or exposed copper that may have resulted during shipping. If there is a defect in the wire, do not attempt installation. Please call our Customer Service Team at 1-800-986-3460.

 **WARNING:** Before starting installation of this fixture or removal of a previous fixture, disconnect the power by turning off the circuit breaker or by removing the fuse at the fuse box.

# Warranty

The manufacturer warrants this lighting fixture to be free from defects in materials and workmanship for a period of one (1) year from date of purchase. This warranty applies only to the original consumer purchaser and only to products used in normal use and service. If this product is found to be defective, the manufacturer’s only obligation, and your exclusive remedy, is the repair or replacement of the product at the manufacturer’s discretion, provided that the product has not been damaged through misuse, abuse, accident, modifications, alterations, neglect, or mishandling. This warranty shall not apply to any product that is found to have been improperly installed, set-up, or used in any way not in accordance with the instructions supplied with the product. This warranty shall not apply to a failure of the product as a result of an accident, misuse, abuse, negligence, alteration, faulty installation, or any other failure not relating to faulty material or workmanship. This warranty shall not apply to the finish on any portion of the product, such as surface and/or weathering, as this is considered normal wear and tear. The manufacturer does not warrant and specifically disclaims any warranty, whether express or implied, of fitness for a particular purpose, other than the warranty contained herein. The manufacturer specifically disclaims any liability and shall not be liable for any consequential or incidental loss or damage, including but not limited to any labor / expense costs involved in the replacement or repair of said product.

Contact the Customer Service Team at 1-800-986-3460 or visit [www.homedepot.com/homedecorators](http://www.homedepot.com/homedecorators).

# Pre-Installation

## PLANNING INSTALLATION

- Read all instructions before installation.
- To avoid damaging this product, assemble it on a soft, non-abrasive surface, such as carpet or cardboard.
- Keep your receipt and these instructions for proof of purchase.

## TOOLS REQUIRED



Ladder



Safety glasses



Electrical tape



Phillips screwdriver



Flat blade screwdriver



Pliers

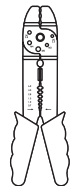

Wire strippers

## HARDWARE INCLUDED



**NOTE:** Hardware not shown to actual size.



AA



BB

Part	Description	Quantity
AA	Pre-assembled nut	2
BB	Wire nut	3

# Pre-Installation (continued)

## PACKAGE CONTENTS

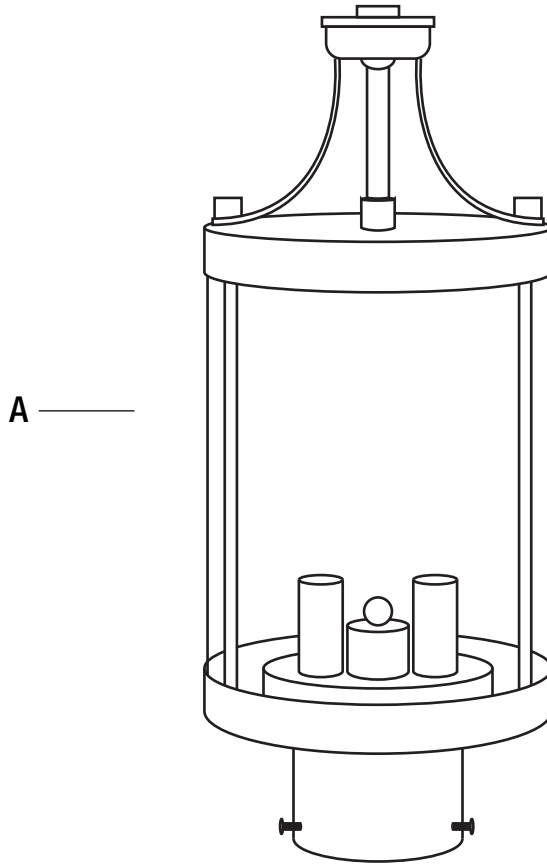

Part	Description	Quantity
A	Light fixture with pre-assembled screws	1

# Installation

## 1 Making the electrical connections

- Connect the black to black (power), the white to white (neutral) and copper wire to ground wire with the wire nuts (BB) and secure with electrical tape (not included).

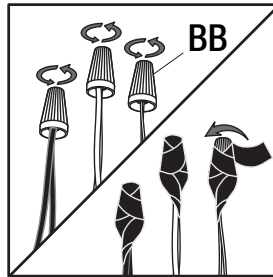

**NOTE:** If the wires from the fixture are the same color, attach the side with markings or letters to the black (positive) wire and the other to the white (neutral) wire.

## 2 Installing the light bulbs

- Unscrew pre-assembled nuts (AA) and remove the cover.
- Install two E12 60-watt bulbs (not included).
- Place the cover back on the light fixture and secure with pre-assembled nuts (AA).

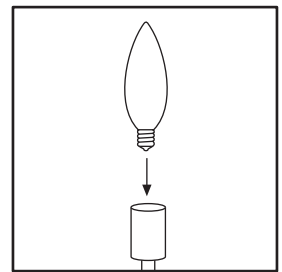
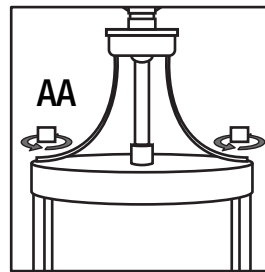

## 3 Securing the light fixture

- Install the fixture (A) to the pole or base (not included) and secure with pre-assembled screws.

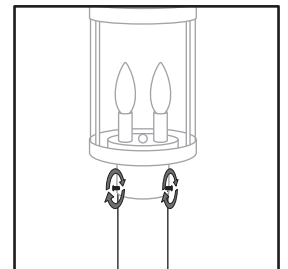
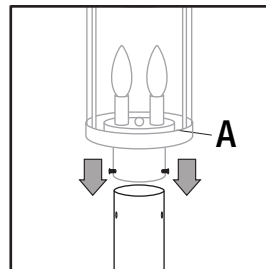

## Operation

### 1 Turning the light on

- Turn the light switch on to activate the fixture.

## Care and Cleaning

- Clean the lamp with a soft, dry cloth.
- Do not use any cleaners with chemicals, solvents, or harsh abrasives.

## Troubleshooting

Problem	Possible Cause	Solution
The bulb will not light.	The bulb is burned out.	Replace the light bulb.
	The power is off.	Ensure the power supply is On.
	There is a faulty wire connection.	Check the wiring.
	The circuit breaker is off.	Ensure the circuit breaker is in the On position.
The fuse blows or circuit breaker trips when the light is turned on.	There are crossed wires or the power wire is grounding out.	Check the wire connections. Contact a qualified electrician or call the Customer Service Team at 1-800-986-3460.

# HOME DECORATORS COLLECTION

Questions, problems, missing parts? Before returning to the store,  
call Home Decorators Collection Customer Service.  
8 a.m. - 7 p.m., EST, Monday-Friday, 9 a.m. - 6 p.m., EST, Saturday

**1-800-986-3460**

**[HOMEDEPOT.COM/HOMEDECORATORS](http://HOMEDEPOT.COM/HOMEDECORATORS)**

Retain this manual for future use.