

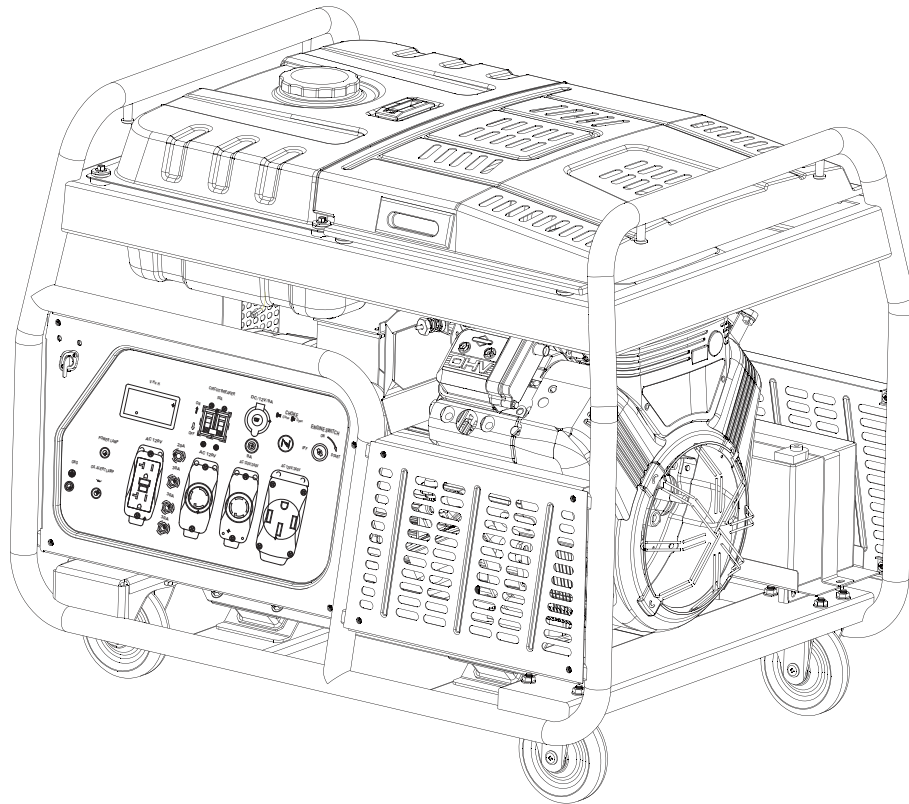

A-iPOWER

PORTABLE GENERATOR

Owner's Manual



SAVE THIS MANUAL FOR FUTURE REFERENCE

IMPORTANT SAFETY INSTRUCTIONS ARE INCLUDED IN THIS MANUAL

**CUSTOMER SERVICE
SERVICE CLIENTELE
SERVICIO AL CLIENTE
1-855-888-3598**

**A-iPOWER Corp.
1477 E. Cedar St. #B,
Ontario, CA 91761
U.S.A.
www.a-ipower.com**

TABLE OF CONTENTS

Safety Rules2-4
 Know Your Generator5
 Assembly 6
 Using the generator7
 Operation8-10
 Specifications 11
 Maintenance/Storage 12
 Diagram 13
 Troubleshooting 14
 Warranties 15

EQUIPMENT DESCRIPTION



Read this manual carefully and become familiar with your generator. Know its applications, its limitations and any hazards involved.

These generators are engine-driven, revolving field, alternating current (AC) generators. Each was designed to supply electrical power for operating compatible electrical lighting, appliances, tools and motor loads. The generator’s revolving field is driven at 3,600 rpm by a V-Twin engine.

CAUTION! DO NOT exceed the generator’s wattage/amperage capacity. See “Don’t Overload Generator”.

Every effort has been made to ensure that information in this manual is accurate and current. However, we reserve the right to change, alter or otherwise improve the product and this document at any time without prior notice.

All rights reserved, no part of this material may be reproduced or transmitted in any form by any means without the express written permission of A-iPower

SAFETY RULES

This is the safety alert symbol. It is used to alert you to potential personal injury hazards. Obey all safety messages that follow this symbol to avoid possible injury or death.

The safety alert symbol (⚠) is used with a signal word (DANGER, CAUTION, WARNING), a pictorial and/or a safety message to alert you to hazards. **DANGER** indicates a hazard which, if not avoided, will result in death or serious injury. **WARNING** indicates a hazard which, if not avoided, could result in death or serious injury. **CAUTION** indicates a hazard which, if not avoided, might result in minor or moderate injury.

CAUTION, when used without the alert symbol, indicates a situation that could result in equipment damage. Follow safety messages to avoid or reduce the risk of injury or death.

⚠ WARNING

The engine exhaust from this product contains chemicals which could cause cancer, birth defects, or other reproductive harm.

Hazard Symbols and Meanings

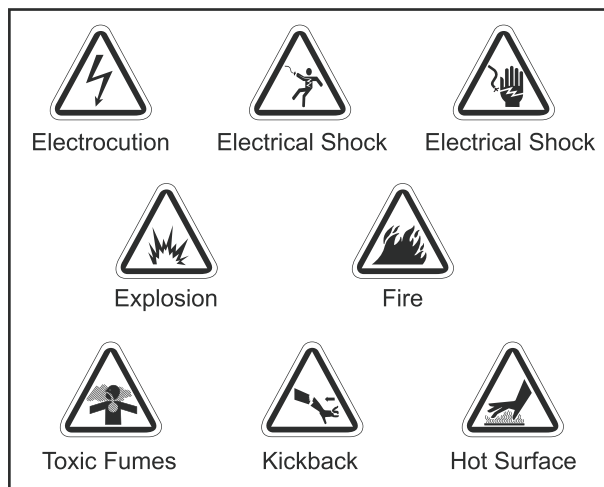

 **WARNING**

 Running generator gives off carbon monoxide, an odorless, colorless, poison gas. Breathing carbon monoxide will cause nausea, fainting or death.

- Operate generator ONLY outdoors.
- Keep exhaust gas from entering a confined area through windows, doors, ventilation intakes or other openings.
- DO NOT operate generator inside any building or enclosure, including the generator compartment of a recreational vehicle (RV).

 **WARNING**

 Generator produces powerful voltage. Failure to isolate generator from power utility can result in death or injury to electric utility workers due to backfeed of electrical energy.

- When using generator for backup power, notify utility company. Use approved transfer equipment to isolate generator from electric utility.
- Use a ground fault circuit interrupter (GFCI) in any damp or highly conductive area, such as metal decking or steel work.
- DO NOT touch bare wires or receptacles.
- DO NOT use generator with electrical cords which are worn, frayed, bare or otherwise damaged.
- DO NOT operate generator in the rain.
- DO NOT handle generator or electrical cords while standing in water, while barefoot, or while hands or feet are wet.
- DO NOT allow unqualified persons or children to operate or service generator.

 **WARNING**

- This generator must not be used on marine applications.
- Using this generator in marine applications could result in bodily injury and/or property damage.

 **WARNING**

 Petrol and its vapors are extremely flammable and explosive.

 Fire or explosion can cause severe burns or death.

WHEN ADDING OR DRAINING PETROL

- Turn generator OFF and let it cool at least 2 minutes before removing petrol cap. Loosen cap slowly to relieve pressure in tank.
- Fill or drain petrol tank outdoors.
- DO NOT overfill tank. Allow space for petrol expansion.
- Keep petrol away from sparks, open flames, pilot lights, heat, and other ignition sources.
- DO NOT light a cigarette or smoke.

WHEN STARTING EQUIPMENT

- Ensure spark plug, muffler, petrol cap and air cleaner are in place.
- DO NOT crank engine with spark plug removed.
- If petrol spills, wait until it evaporates before starting engine.

WHEN OPERATING EQUIPMENT

- DO not tip engine or equipment at angle which causes petrol to spill.
- This generator is not for use in mobile equipment or marine applications.

WHEN TRANSPORTING OR REPAIRING EQUIPMENT

- Transport/repair with petrol tank EMPTY or with petrol shutoff valve OFF.
- Disconnect spark plug wire.

WHEN STORING PETROL OR EQUIPMENT WITH PETROL IN TANK



- Store away from furnaces, stoves, water heaters, clothes dryers or other appliances that have pilot light or other ignition source because they can ignite petrol vapors.

 **WARNING**

 Rapid retraction of starter cord (kickback) will pull hand and arm toward engine faster than you can let go.
Broken bones, fractures, bruises or sprains could result.

- When starting engine, pull cord slowly until resistance is felt and then pull rapidly to avoid kickback.
- NEVER start or stop engine with electrical devices plugged in and turned on.

 **WARNING**



 Unintentional sparking can result in fire or electric shock.



WHEN ADJUSTING OR MAKING REPAIRS TO YOUR GENERATOR

- Disconnect the spark plug wire from the spark plug and place the wire where it cannot contact spark plug.

WHEN TESTING FOR ENGINE SPARK

- Use approved spark plug tester.
- DO NOT check for spark with spark plug removed.

 **WARNING**

 Running engines produce heat. Temperature of muffler and nearby areas can reach or exceed 65°C (150°F).
 Severe burns can occur on contact.
Combustible debris, such as leaves, grass, brush, ect. can catch fire.

- DO NOT touch hot surfaces.
- Allow equipment to cool before touching.
- The generator must be at least 2m (5 ft) from structures having combustible walls and/or other combustible materials.
- Keep at least 1m (3 ft) of clearance on all sides of generator for adequate cooling, maintenance and servicing.

 **CAUTION**

Excessively high operating speeds increase risk of injury and damage to generator.
Excessively low speeds impose a heavy load.

- DO NOT tamper with governed speed. Generator supplies correct rated frequency and voltage when running at governed speed.
- DO NOT modify generator in any way.

CAUTION

Exceeding generators wattage/amperage capacity can damage generator and/or electrical devices connected to it.

- See “Don’t Overload Generator”.
- Start generator and let engine stabilize before connecting electrical loads.
- Connect electrical loads in OFF position, then turn ON for operation.
- Turn electrical loads OFF and disconnect from generator before stopping generator.

CAUTION

Improper treatment of generator can damage it and shorten its life.

- Use generator only for intended uses.
- Operate generator only on level surfaces.
- DO NOT expose generator to excessive moisture, dust, dirt, or corrosive vapors.
- DO NOT insert any objects through cooling slots.
- If connected devices overheat, turn them off and disconnect them from generator.
- Shut off generator if:
 - electrical output is lost;
 - equipment sparks, smokes, or emits flames;
 - unit vibrates excessively.

KNOW YOUR GENERATOR

Read this owner's manual and safety rules before operating your generator.

Compare the illustrations with your generator, to familiarize yourself with the locations of various controls and adjustments. Save this manual for future reference.

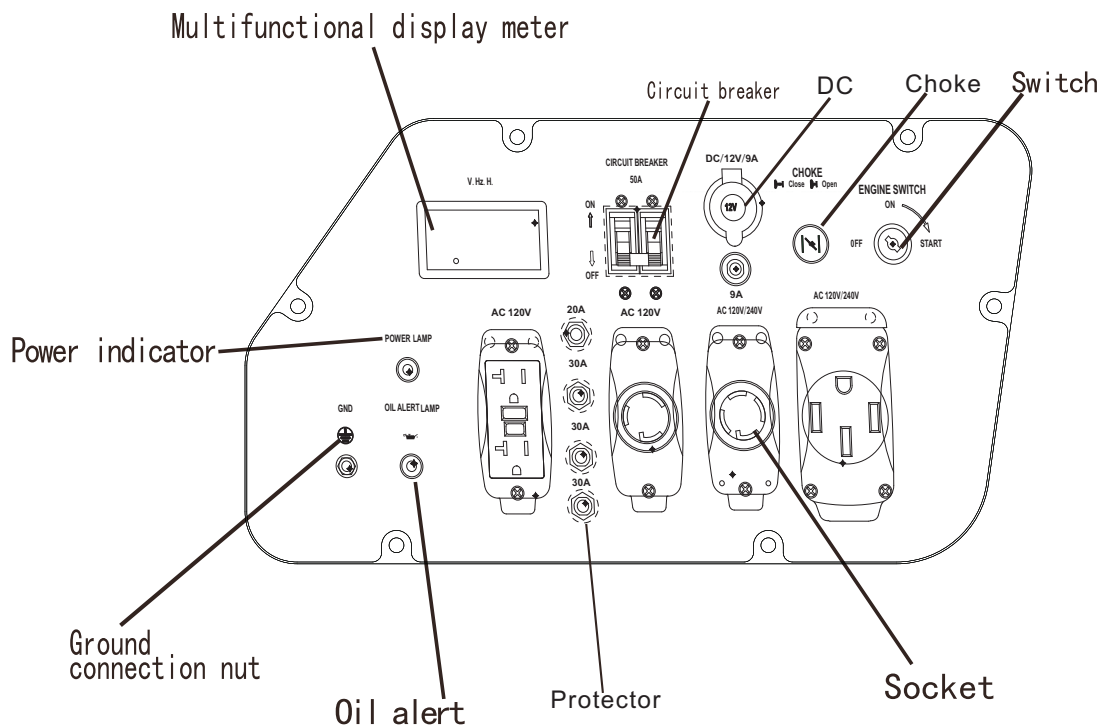
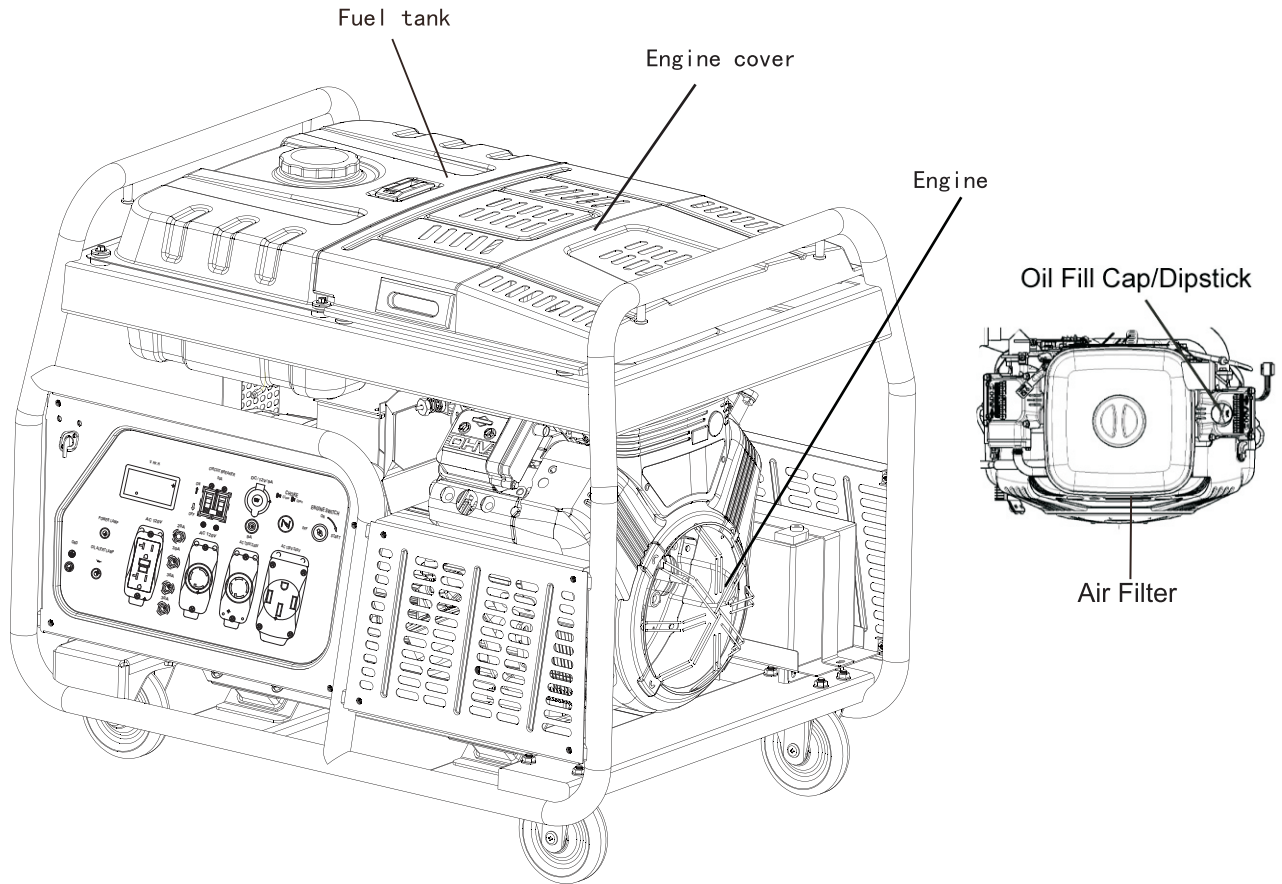

ASSEMBLY

Your generator requires some assembly and is ready for use after it has been properly serviced with the recommended oil and petrol.

Remove Generator From Plywooden Case

1. Set plywooden case on a rigid flat surface.
2. Carefully cut the packing straps of plywooden case.
3. Remove the whole plywooden case upward with two people by holding its side face at the same time.
4. Remove all fixed Bolt which were attached to the base pallet.
5. Remove generator from the pallet.

BEFORE STARTING THE ENGINE

Add Engine Oil

- Place generator on a level surface.

CAUTION

Any attempt to crank or start the engine before it has been properly filled with the recommended oil will result in equipment failure.

- Please fill the engine with 1.3L qualified engine oil.
- Damage to equipment resulting from failure to follow this instruction will void warranty.

NOTE: Check oil often during engine break-in.

NOTE: The generator assembly rotates on a prelubricated and sealed ball bearing that requires no additional lubrication for the life of the bearing.

Add Petrol

NOTE: This engine is certified to operate on petrol only. It will not operate on paraffin, diesel or other fuels.



WARNING



Petrol and its vapors are extremely flammable and explosive.



Fire or explosion can cause severe burns or death.

WHEN ADDING PETROL

- Turn generator OFF and let it cool at least 2 minutes before removing petrol cap. Loosen cap slowly to relieve pressure in tank.
- Fill petrol tank outdoors.
- DO NOT overfill tank. Allow space for petrol expansion.
- Keep petrol away from sparks, open flames, pilot lights, heat, and other ignition sources.
- DO NOT light a cigarette or smoke.

1. Use clean, fresh, regular UNLEADED petrol with a minimum of 85 octane. DO NOT use petrol which contains Methanol. DO NOT mix oil with petrol.
2. Clean area around petrol fill cap, remove cap.
3. Add regular unleaded petrol to petrol tank. Be careful not to overfill. Allow about 4cm (1.5") of tank space for petrol expansion (Figure 1).

Figure 1 – Petrol Expansion Space

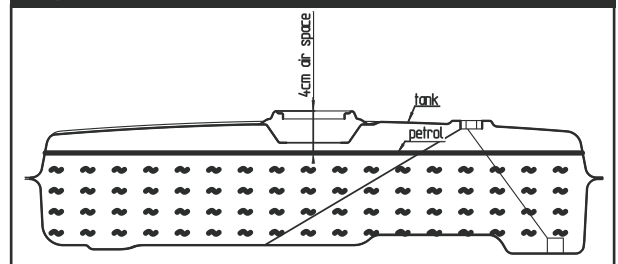

4. Install petrol cap and wipe up any spilled petrol.

USING THE GENERATOR

System Ground

The generator has a system ground that connects the generator frame components to the ground terminals on the AC output receptacles.



Special Requirements

There may be National regulations, local codes, or ordinances that apply to the intended use of the generator. Please consult a qualified electrician, electrical inspector, or the local agency having jurisdiction.

- In some areas, generators are required to be registered with local utility companies.
- If the generator is used at a construction site, there may be additional regulations which must be observed.



Connecting to a Building's Electrical System

Connections for standby power to a building's electrical system must be made by a qualified electrician. The connection must isolate the generator power from utility power, and must comply with all applicable laws and electrical codes.

	WARNING
	Generator produces powerful voltage. Failure to isolate generator from power utility can result in death or injury to electric utility workers due to backfeed of electrical energy.
<ul style="list-style-type: none">• When using generator for backup power, notify utility company. Use approved transfer equipment to isolate generator from electric utility.• Use a ground fault circuit interrupter (GFCI) in any damp or highly conductive area, such as metal decking or steel work.• DO NOT touch bare wires or receptacles.• DO NOT use generator with electrical cords which are worn, frayed, bare or otherwise damaged.• DO NOT operate generator in the rain.• DO NOT handle generator or electrical cords while standing in water, while barefoot, or while hands or feet are wet.• DO NOT allow unqualified persons or children to operate or service generator.	

Generator Location

Generator Clearance

	WARNING
	Running generator gives off carbon monoxide, an odorless, colorless, poison gas. Breathing carbon monoxide will cause nausea, fainting or death.
<ul style="list-style-type: none">• Operate generator ONLY outdoors.• Keep exhaust gas from entering a confined area through windows, doors, ventilation intakes or other openings.• DO NOT operate generator inside any building or enclosure, including the generator compartment of a recreational vehicle (RV).	

The generator must be at least 2m (5 ft.) from structures having combustible walls and/or other combustible materials. Leave at least 1m (3 ft.) all around generator including overhead, for adequate cooling, maintenance and servicing.

Place generator in a well ventilated area, which will allow for removal deadly exhaust gas. DO NOT place generator where exhaust gas could accumulate and enter inside or be drawn into a potentially occupied building. Ensure exhaust gas is kept away from any windows, doors, ventilation intakes or other openings that can allow exhaust gas to collect in a confined area (Figure 2). Prevailing winds and air currents should be taken into consideration when positioning generator.

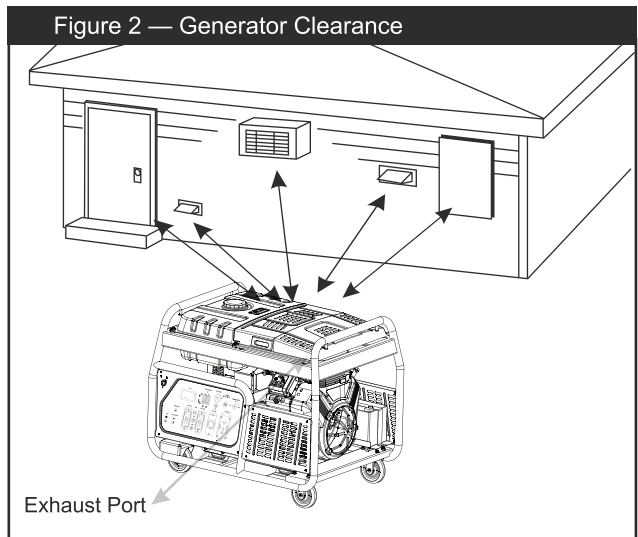

OPERATING THE GENERATOR

CAUTION

Exceeding generators wattage/amperage capacity can damage generator and/or electrical devices connected to it.

- See "Don't Overload Generator".
- Start generator and let engine stabilize before connecting electrical loads.
- Connect electrical loads in OFF position, then turn ON for operation.
- Turn electrical loads OFF and disconnect from generator before stopping generator.

Starting the Engine

Disconnect all electrical loads from the generator. Use the following start instructions:

1. Make sure unit is on a level surface.

IMPORTANT: Failure to start and operate unit on a level surface will cause the unit not to start or shut down during operation.

2. Turn petrol valve to "On" position (Figure 3).

Figure 3 — Petrol Valve

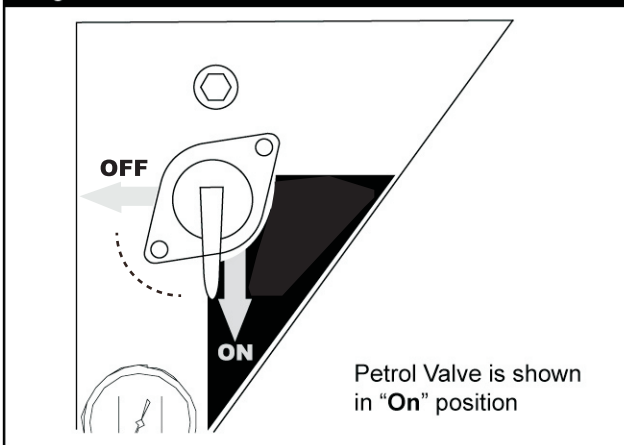

3. Petrol valve is shown in "ON" position.
4. Pull the choke level.
5. Insert the start key and then turn to "START" position;
6. Release the key and it will go back to "ON" position after the the engine being started.

Note: Don't keep the key at "START" position more than 5 seconds each time but you can repeat 5 to 6 steps if engine not running.

7. Push back the choke lever.

NOTE: If engine starts after 3 times but fails to run, or if unit shuts down during operation, make sure unit is on a level surface and check for proper oil level in crankcase. This unit are equipped with a low oil protection device. See engine manual.



WARNING



Running engines produce heat. Temperature of muffler and nearby areas can reach or exceed 65°C (150°F).



Severe burns can occur on contact. Combustible debris, such as leaves, grass, brush, ect. Can catch fire.

- DO NOT touch hot surfaces.
- Allow equipment to cool before touching.
- The generator must be at least 2m (5 ft) from structures having combustible walls and/or other combustible materials.
- Keep at least 1m (3 ft) of clearance on all sides of generator for adequate cooling, maintenance and servicing.

Connecting Electrical Loads

- Let engine stabilize and warm up for a few minutes after starting.
- Plug in and turn on the desired 120V/240V AC, single phase, 60Hz electrical loads.

- DO NOT connect 3-phase loads

- DO NOT connect 50Hz loads

- **DO NOT OVERLOAD THE GENERATOR.** See "Don't Overload Generator".

Stopping the Engine

1. Turn OFF and unplug all electrical loads from generator panel receptacles. NEVER start or stop engine with electrical devices plugged in and turned ON.
2. Let engine run at no-load for several minutes to stabilize internal temperatures of engine and generator.
3. Turn back the start key to "OFF" position, switch off the engine.
4. Move petrol valve to "Off" position.

RECEPTACLES

CAUTION

Receptacles may be marked with rating value greater than generator output capacity.

- NEVER attempt to power a device requiring more amperage than generator or receptacle can supply.
- DO NOT overload the generator. See "Don't Overload Generator".

Digital Hour Meter Displayer

The Hour Meter indicates the per running time & total running time. Push the button at the lower right corner could switch each parameter easily.



Circuit Breaker

The Circuit Breaker is rated at 50A.

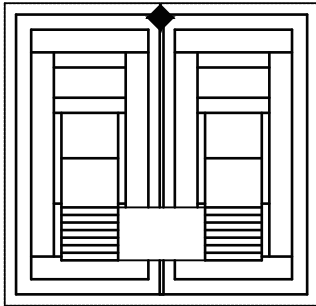

120V/240V AC, 50A Receptacle

Connect a 120V, total output require 6KVA. Connect at 240V, total output require 12KVA

COLD WEATHER OPERATION

Under certain weather conditions (temperatures below 40 F [4°C] combined with high humidity), your generator may experience icing of the carburetor and/or the crankcase breather system. To reduce this problem, you need to perform the following:

1. Make sure generator has clean, fresh petrol.
2. Open petrol valve (turn valve to open position).
3. Use SAE 5W-30 oil (synthetic preferred, see engine manual).
4. Check oil level daily or after every eight (8) hours of operation.
5. Maintain generator following "Maintenance Schedule" in engine manual.
6. Shelter unit from elements.

DON'T OVERLOAD GENERATOR

Capacity

You must make sure your generator can supply enough rated (running) and surge (starting) watts for the items you will power at the same time. Follow these simple steps:

1. Select the items you will power at the same time.
2. Total the rated (running) watts of these items. See Figure 6.
3. Estimate how many surge (starting) watts you will need. Surge wattage is the short burst of power needed to start electric motor-driven tools or appliances. Total surge watts is estimated by adding only the one item with the highest additional surge watts to the total rated watts from step 2.

For Example:

Tool or Appliance	Rated (Running) Watts	Additional Surge (starting) Watts
Refrigerator	800	1600
Deep Freezer	500	500
Television	500	-
Light (75 Watts)	75	-
	1875 Total Running Watts	1600 Highest Surge Watts

Total Rated (Running) Watts = 1875
 Highest Additional Surge Watts = 1600
 Total Generator Output Required = 3475

Power Management

It is important to take care when adding electrical loads to your generator. The correct and safe way to manage generator power is to sequentially add loads as follows:

1. With nothing connected to the generator, start the engine as described in this manual.
2. Plug in and turn on the first load, preferably the largest load you have.
3. Permit the generator output to stabilize (engine runs smoothly and attached device operates properly.)
4. Plug in and turn on the next load.
5. Again, permit the generator to stabilize.
6. Repeat steps 4 and 5 for each additional load.

NEVER add more loads than generator capacity. Take special care to consider surge loads in generator capacity, as described above.

Figure 6 — Wattage Reference Chart

Tool or Appliance	Rated* (Running) Watts	Additional Surge (Starting) Watts
Essentials		
Light Bulb – 75 watt	75	-
Deep Freezer	500	500
Sump Pump	800	1200
Refrigerator/Freezer – 18 Cu. Ft.	800	1600
Water Well Pump – 1/3 HP	1000	2000
Heating/Cooling		
Window Fan	300	600
Furnace Fan Blower – 1/2 HP	800	1300
Kitchen		
Microwave Oven – 1000 Watt	1000	--
Coffee Maker	1500	--
Electric Stove – Single Element	1500	--
Hot Plate	2500	--
Family Room		
Stereo Receiver	450	--
Television – 27"	500	--
Personal Computer w/17" monitor	800	---
Other		
AM/FM Clock Radio	300	--
Electric Water Heater – 40 Gallon	4000	--
Quartz Halogen Work Light	1000	--
Airless Sprayer – 1/3 HP	600	1200
Reciprocating Saw	960	960
Electric Drill – 1/2 HP	1000	1000
Circular Saw – 7 1/4"	1500	1500
Miter Saw – 10"	1800	1800
Table Saw/Radial Arm Saw-10"	2000	2000
Air Compressor – 1 – 1/2 HP	2500	2500

* Wattages listed are approximate only. Check tool or appliance for actual wattage.

SPECIFICATIONS

Model	SUA15000EC
Engine	24hp Twin-Cylinder
Displacement	680cc
Rated frequency	60HZ
Rated voltage	120V/240V
Running Watts	12000KW
Starting Watts	15000KW
Fuel tank capacity	8Gallon
Full load continuous running time	4.5h
1/2 load continuous running time	9h

DIAGRAM

SUA15000EC

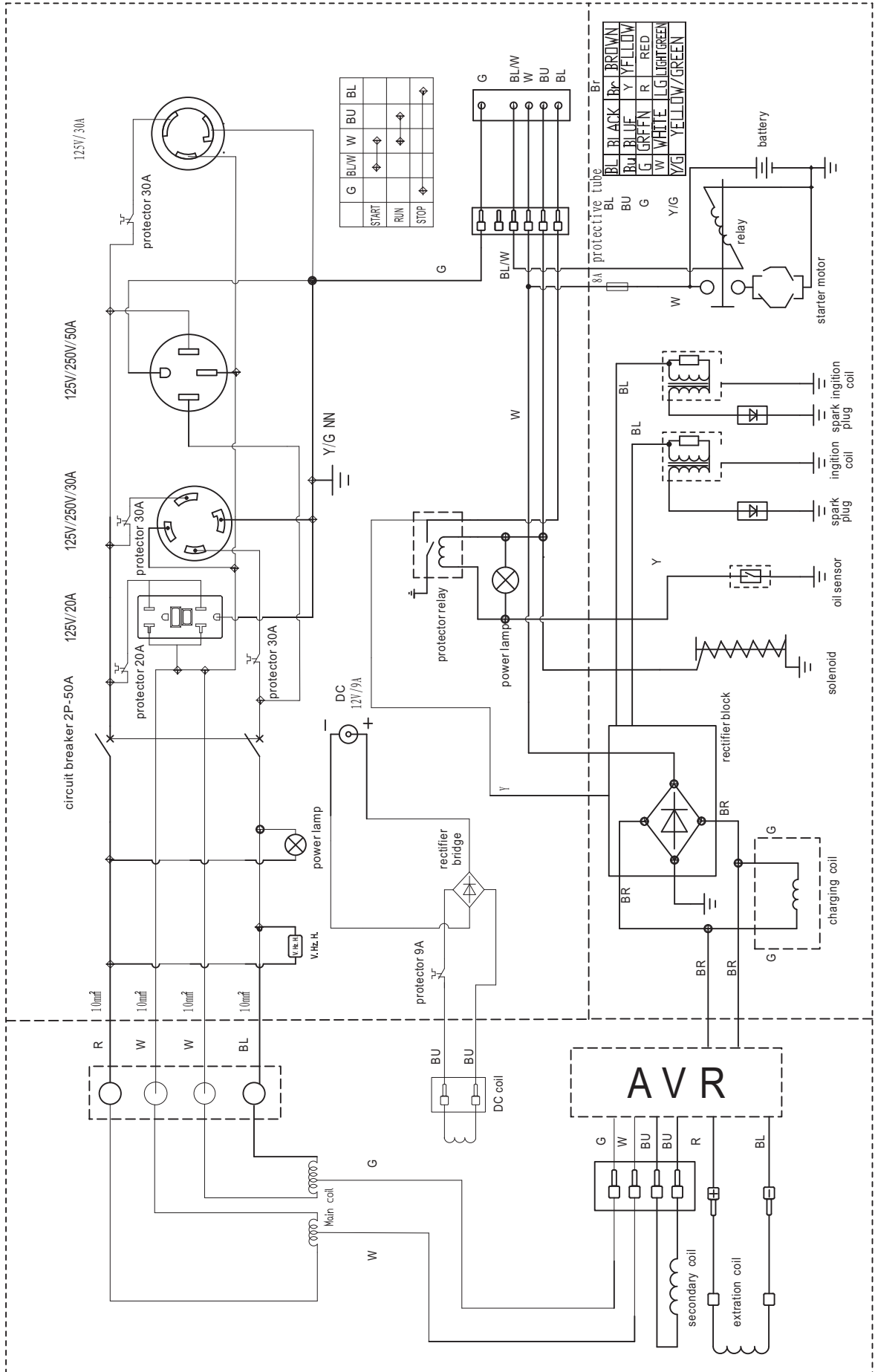

GENERAL MAINTENANCE RECOMMENDATIONS

The Owner/Operator is responsible for making sure that all periodic maintenance tasks are completed on a timely basis; that all discrepancies are corrected; and that the unit is kept clean and properly stored. **NEVER operate a damaged or defective generator.**

Engine Maintenance

For further services, kindly please turn to A-iPower Authorized Service Center.



CAUTION

Avoid prolonged or repeated skin contact with used motor oil.

- Used motor oil has been shown to cause skin cancer in certain laboratory animals.
- Thoroughly wash exposed areas with soap and water.



KEEP OUT OF REACH OF CHILDREN.
DON'T POLLUTE. CONSERVE RESOURCES.
RETURN USED OIL TO COLLECTION CENTERS.

Generator Maintenance

Generator maintenance consists of keeping the unit clean and dry. Operate and store the unit in a clean dry environment where it will not be exposed to excessive dust, dirt, moisture or any corrosive vapors. Cooling air slots in the generator must not become clogged with snow, leaves or any other foreign material.

NOTE: DO NOT use a garden hose to clean generator. Water can enter engine petrol system and cause problems. In addition, if water enters generator through cooling air slots, some of the water will be retained in voids and cracks of the rotor and stator winding insulation. Water and dirt buildup on the generator internal windings will eventually decrease the insulation resistance of these windings.



WARNING



Unintentional sparking can result in fire or electric shock.



WHEN ADJUSTING OR MAKING REPAIRS TO YOUR GENERATOR

- Disconnect the spark plug wire from the spark plug and place the wire where it cannot contact spark plug.

WHEN TESTING FOR ENGINE SPARK

- Use approved spark plug tester.
- DO NOT check for spark with spark plug removed.

Generator Cleaning

- Use a damp cloth to wipe exterior surfaces clean.

CAUTION

Improper treatment of generator can damage it and shorten its life.

- DO NOT expose generator to excessive moisture, dust, dirt, or corrosive vapors.
- DO NOT insert any objects through cooling slots.

- Use a soft bristle brush to loosen caked on dirt or oil.
- Use a vacuum cleaner to pick up loose dirt and debris.
- Use low pressure air (not exceed 1.7 bar/25 psi) to blow away dirt. Inspect cooling air slots and opening on generator. These openings must be kept clean and unobstructed.

STORAGE

The generator should be started at least once every seven days and allowed to run at least 30 minutes. If this cannot be done and you must store the unit for more than 30 days, use the following guidelines to prepare it for storage.

Generator Storage

- Clean the generator as outlined in "Generator Cleaning".
- Check that cooling air slots and openings on generator are open and unobstructed.



WARNING

Storage covers can be flammable.

- DO NOT place a storage cover over a hot generator.
- Let equipment cool for a sufficient time before placing the cover on the equipment.

Engine Storage

Please turn to A-iPower Authorized Service Center for help if there is a need.

Other Storage Tips

- To prevent gum from forming in petrol system or on essential carburetor parts, add petrol stabilizer into petrol tank and fill with fresh petrol. Run the unit for several minutes to circulate the additive through the carburetor. The unit and petrol can then be stored for up to 24 months. Petrol stabilizer can be purchased locally.
- DO NOT store petrol from one season to another unless it has been treated as described above.
- Replace petrol container if it starts to rust. Rust and/or dirt in petrol can cause problems if it's used with this unit.
- Store unit in a clean and dry area.

TROUBLESHOOTING

Problem	Cause	Solution
Engine is running, but no AC output is available.	<ol style="list-style-type: none"> 1. Circuit breaker is open. 2. Poor connection or defective cord set. 3. Connected device is bad. 4. Fault in generator. 	<ol style="list-style-type: none"> 1. Reset circuit breaker. 2. Check and repair. 3. Connect another device that is in good condition. 4. Contact A-iPower Authorized service Center.
Engine runs good but bogs down when loads are connected.	<ol style="list-style-type: none"> 1. Short circuit in a connected load. 2. generator is overloaded. 3. Shorted generator circuit. 	<ol style="list-style-type: none"> 1. Disconnect shorted electrical load. 2. See "Don't Overload Generator". 3. Contact A-iPower Authorized service Center.
Engine will not start; or starts and runs rough.	<ol style="list-style-type: none"> 1. Out of petrol. 2. Petrol valve is in the "Closed" position. 3. Low oil level. 	<ol style="list-style-type: none"> 1. Fill petrol tank. 2. Turn petrol valve to the "Open" position. 3. Fill crankcase to proper level.
Engine shuts down during operation.	<ol style="list-style-type: none"> 1. Out of petrol. 2. Low oil level. 3. Generator tipped at angle. 	<ol style="list-style-type: none"> 1. Fill petrol tank. 2. Fill crankcase to proper level. 3. Place generator on level surface.
Engine lacks power.	Load is too high.	See "Don't Overload Generator".

WARRANTIES

UNITED STATES EMISSION CONTROL DEFECTS WARRANTY STATEMENT

Under U.S. EPA regulations, A-iPOWER are pleased to explain the Emission Control System Warranty on your model year 2015-2016 and later spark ignited small off-road engine. In all areas of the United States, your engine must be designed, built and equipped to meet U.S. EPA and CARB emission standards for spark ignited small off-road engines at or below 19 kilowatts.

A-iPOWER must warrant the emission control system on your engine for the period of time listed below, provided there has been no abuse, neglect or improper maintenance on your spark ignited small off-road engine. Where a warrantable condition exists, A-iPOWER will repair your spark ignited small off-road engine at no cost to you including diagnosis, parts and labor. Your emission control system includes parts such as carburetor, air cleaner, ignition system, muffler and catalytic converter (when present). Also included may be hoses, connectors, and other emission-related assemblies.

A-iPOWER EMISSION CONTROL DEFECTS WARRANTY COVERAGE

Spark ignited small off-road engines are warranted relative to emission control parts defects for a period of two (2) years, subject to the provisions stated below. If any emission related part on your engine is defective, the part will be repaired or replaced by A-iPOWER. The warranty period begins on the date the product is delivered to the initial owner.

OWNER'S WARRANTY RESPONSIBILITY

As the spark ignited small off-road engine owner, you are responsible for the maintenance required, what are listed in the owner's manual.

A-iPOWER recommends that you retain all receipts covering maintenance on your spark ignited small off-road engine, but A-iPOWER cannot deny warranty solely for the lack of receipts or for your failure to ensure the performance of all scheduled maintenance.

As the owner of a spark ignited small off-road engine, you should however be aware that A-iPOWER may deny you warranty coverage if your spark ignited small off-road engine or part has failed due to abuse, neglect, improper maintenance or unapproved modifications.

You are responsible for presenting your spark ignited small off-road engine to an authorized service center as soon as a problem exists. The undisputed warranty repairs should be completed in a reasonable period of time, not to exceed 30 days. For the location of an authorized service center and any questions you may have regarding your warranty rights and responsibilities, you should **call our parts and technical support group toll free at 855-888-3598, Mon-Fri, 8:00 AM to 5:00 PM Pacific Standard Time.**

The emission warranty is a defects warranty and defects are judged on normal engine performance. The warranty is not related to an in-use emission test.

EMISSION CONTROL SYSTEM WARRANTED PARTS

Coverage under this warranty extends only to the parts listed below (the emission control system parts) to the extent that these parts were present on the engine purchased.

- Fuel Metering System
- Carburetor and/or internal parts
- Intake manifold
- Evaporative System
- Fuel tank, Fuel cap, and tether.
- Air Induction System
- Air cleaner*
- Intake manifold
- Exhaust System
- Exhaust manifold
- Catalyst
- Ignition System
- Flywheel magneto
- Ignition coil assembly
- Spark plug*
- Crankcase Emission Control System
- Crankcase breather tube

Oil filler cap
Miscellaneous parts
Hoses, seals, gaskets, connectors and assemblies associated with listed parts

Note: * Covered up to the first required replacement only. See the maintenance schedule in the Owner's Manual.

COVERAGE TERM

A-iPOWER warrants to the initial owner and each subsequent purchaser that the spark ignited small off-road engine is free from defects in materials and workmanship which can cause the failure of an emission warranted part for a period of two (2) years after the engine is delivered to the original retail purchaser. Warranty coverage shall extend to the failure of any engine components caused by the failure of any warranted part still under warranty.

LIMITATIONS

The Emission Control System Warranty shall NOT cover any of the following:

- (a) Repair or replacement required as the result of misuse or neglect, improper maintenance or unapproved modifications, repairs improperly performed or replacement improperly installed, use of unapproved replacement parts or accessories and modifications not recommended by A-iPOWER.
- (b) Replacement parts, other services and adjustments necessary for normal maintenance.
- (c) Transportation to and from the authorized service center or retailer.

LIMITED LIABILITY

The liability of A-iPOWER under this Emission Control System Warranty is limited solely to the remedy of defects in materials or workmanship. This warranty does not cover inconvenience or loss of the spark ignited small off-road engine equipment or transportation of same to an authorized service center. A-iPOWER shall not be liable for any other expenses, loss, or damage, whether direct, incidental, consequential (except as listed) or exemplary arising in connection with the sale or use of or inability to use the spark ignited small off-road engine equipment for any other purpose.

No express Emission Control System Warranty is given by Aipower with respect to the engine except as specifically set forth in this document. Any Emission Control System Warranty implied by law, including any warranty of merchantability or fitness for a particular purpose, is expressly limited to the Emission Control System Warranty terms set forth in this document.

A-iPOWER GENERATOR OWNER LIMITED WARRANTY POLICY

THANK YOU FOR CHOOSING A-iPOWER GENERATOR! OUR WARRANTY

A-iPOWER will, at its option, free of charge, repair or replace any part(s) which, upon examination, inspection and testing by A-iPOWER or an A-iPOWER Authorized Warranty Service Dealer, that is defective in material or workmanship or both. Transportation charges on product submitted for repair or replacement under this warranty must be borne by purchaser. Retain your proof-of-purchase receipt. If you do not provide proof of the initial purchase date, the manufacturer's shipping date of the product will be used to determine the warranty period starting.

WARRANTY TERM

Any new A-iPOWER generator purchased for non-commercial use from an authorized A-iPOWER generator dealer in the continental North America will be warranted against defects in material or workmanship for a period of **two years**, from date of purchase, subject to exclusions noted herein. Commercial and rental applications are warranted for **one year**. The warranty period begins on the date of purchase by the first retail end-user, and continues for the period of warranty time. A-iPOWER customer service will keep on supplying spare parts per request after warranty period with cost charge.

"Consumer Use" means residential household using by a retail consumer. "Commercial Use" means all other uses, including used for commercial, industrial or business or rental purposes. Once equipment has experienced commercial use, it shall thereafter be considered as commercial use for purposes of this warranty.

HOW TO OBTAIN WARRANTY SERVICE

Please call our customer service number 1-855-888-3598, or email to:

support@a-ipower.com to contact our support team at first in case of a service needed. Please prepare and provide the model number, serial number and the proof of purchase while contacting us. or mail a request to:

A-iPOWER Corp.
1477 E. Cedar St. Unit B
Ontario, CA 91761
USA

ABOUT YOUR WARRANTY

We welcome warranty repair and apologize to you for being inconvenienced. Any Authorized Service Dealer may perform warranty repairs. Most warranty repairs are handled routinely, but sometimes requests for warranty service may not be appropriate. For example, warranty service would not apply if equipment damage occurred because of misuse, lack of routine maintenance, shipping, handling, warehousing or improper installation. Similarly, the warranty is void if the manufacturing date or the serial number on the portable generator has been removed or the equipment has been altered or modified. During the warranty period, the Authorized Service Dealer, at its option, will repair or replace any part that, upon examination, is found to be defective under normal use and service. This warranty will not cover the following repairs and equipment:

- **REGULAR WEARING:** Outdoor Power Equipment, as with all mechanical devices, need periodic part(s) service and replacement to perform as designed. This warranty will not cover repair when normal use has exhausted the life-time of a part(s) or engine.
- **INSTALLATION AND MAINTENANCE:** This warranty does not cover the generators or its parts what have been subjected to improper or unauthorized assembled, altered, modified, or damaged due to misusing, negligence, accident, overloading, over-speeding, improper maintenance, repair or storage so as, in our judgment, to adversely affect its performance and reliability. This warranty also does not cover regular maintenance and parts such as air filters,

adjustments, fuel system cleaning and obstruction (due to chemical, dirt, carbon, lime, and so forth).

- **OTHER EXCLUSIONS:** This warranty excludes wearing parts such as o-rings, filters, etc., or malfunctions resulting from accidents, abuse, modifications, alterations, or improper servicing or freezing or chemical deterioration; Damaged related to rodent and/or insect infestation. Accessory parts such as starting batteries, generator adapter cord sets and storage covers are excluded from the product warranty. This warranty excludes used, reconditioned, and demonstration equipment, equipment used for prime power in place of utility power, equipment used in life support applications, and failures due to acts of God and other force majeure events beyond the manufacturers control, such as collision, theft, vandalism, riot or wars, nuclear holocaust, fire, freezing, lightning, earth-quake, windstorm, hail, volcanic eruption, water or flood, tornado or hurricane.

A-iPOWER's only liability shall be the repair or replacement of part(s) as stated above in no event shall A-iPOWER be liable for any incidental or consequential or consequential damages, even if such damages are a direct result of A-iPOWER's negligence. Overnight freight or special shipping costs for replacement part(s) or overtime, holiday or emergency labor will be borne by purchaser.

THIS IS THE ONLY EXPRESS WARRANTY ON OUR PRODUCTS

We neither assume nor authorize anyone to assume for us any other express warranty. The A-iPOWER Distributor/ Dealer have no authority to make any representation or promise on behalf of A-iPOWER or to modify the terms or limitations of this warranty in any way.

THIS WARRANTY GIVES YOU SPECIFIC LEGAL RIGHTS. AND YOU MAY ALSO HAVE OTHER RIGHTS WHICH VARY FROM STATE TO STATE.

A-iPOWER WARRANTY CLAIM FORM

www.a-ipower.com
support@a-ipower.com

Primary Information

Circle one: Consumer Dealer Service

Did you send in your Warranty Card? If not, proof of purchase is required. Yes No

Have you ever had a warranty issue with the same unit before? Yes No

Name: _____

Phone: _____

Address: _____

City, State, Zip code: _____

Date of purchase: _____ **Where:** _____

Internal Use

Serial Number

Model

Color

Claim Number

Registration Number

Problem Description

Action Take

We are professional generators!



1477 E. Cedar Street #B,
Ontario, CA 91761, U.S.A.
Phone: 855-888-3598
626-888-3598
support@a-ipower.com
www. a-ipower.com