

NEWAGE STEEL WELDED CABINETRY INSTALL INSTRUCTIONS

NEWAGE
PRODUCTS INC.

WELCOME TO THE NEWAGE PERFORMANCE CABINETRY SERIES

ALL CABINETS MUST BE MOUNTED TO STUDS ON A SECURE WALL, AS PER THESE INSTRUCTIONS. FAILURE TO DO SO MAY RESULT IN SERIOUS INJURY AND VOIDS PRODUCT WARRANTY AND MANUFACTURER'S LIABILITY.

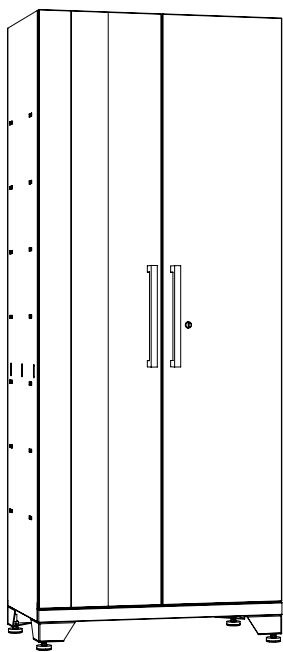

LOCKER CABINET

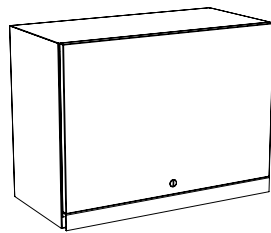

WALL CABINET

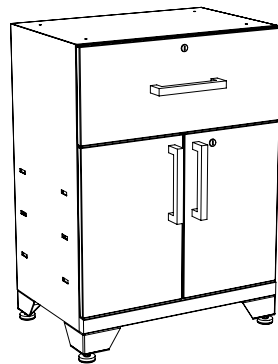

**1 DRAWER, 2 DOOR
BASE CABINET**

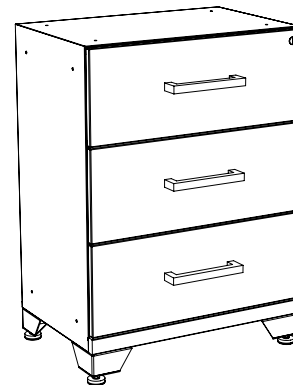

3 DRAWER BASE CABINET

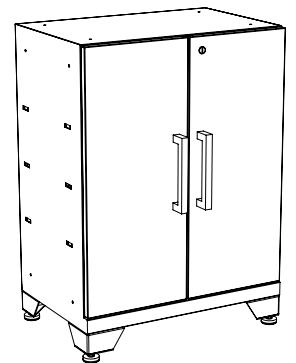

2 DOOR BASE CABINET

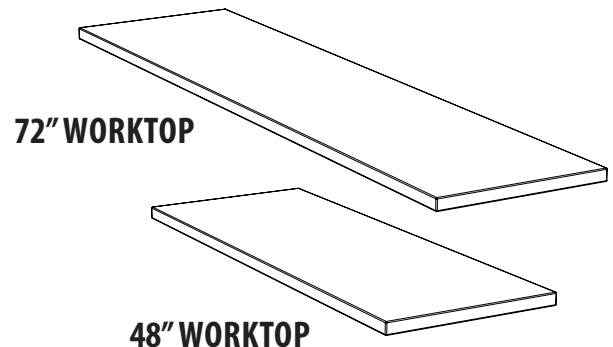

72" WORKTOP

48" WORKTOP

WARNING: EXCESSIVE WEIGHT HAZARD

- Use two or more people to move, assemble or install cabinet or locker.
- Failure to do so can result in back or other injury.

DO NOT LEAVE CHILDREN UNATTENDED NEAR CABINETS. WHEN FULLY LOADED, CABINETS ARE HEAVY AND THERE IS A RISK OF CABINETS OR ITEMS TIPPING IF IMPROPERLY INSTALLED.

NEWAGE STEEL WELDED PERFORMANCE CABINETRY INSTALL INSTRUCTIONS

TOOLS AND PARTS REQUIRED:

Gather the required tools and parts before starting installation.

TOOLS NEEDED:

- 7/16" wrench
- 7/16" socket driver wrench
- Adjustable wrench or pliers
- 12" Magnetic Level
- #2 Philips Bit
- Cordless Power Drill with 7/16" socket attachment
- Tape Measure
- Stud Finder
- Pencil
- Hammer Drill with Masonry Bit (optional)

WARNING: EXCESSIVE WEIGHT HAZARD

- Use two or more people to move, assemble or install cabinet or locker, failure to do so can result in back or other injury.

UNPACKING OF THE CABINETS:

- Begin by placing the cabinet on a sound level surface.
- Remove all cardboard and foam packaging material.
- Remove clear plastic bag.
- Dispose / recycle all packaging materials.
- Remove and verify all the contents in the box. See "Parts and Hardware Supplied List"

NOTE: Grey Caps on Sides of Base Cabinets

If you are installing cabinets beside each other, the grey caps on the sides of the base cabinets must be removed in order to allow the cabinets to sit flush beside each other, without any gaps. The caps can be popped out by hand or with a flat screwdriver head or pliers.

PARTS AND HARDWARE SUPPLIED WITH CABINETS:

Parts	2-Door Base Cabinet	1-Drawer, 2-Door Base Cabinet	Tool Drawer	Locker	Wall Cabinet
Height-Adjustable Steel Leveling Legs	4	4	4	4	0
Threaded Adjustable Leveler	4	4	4	4	0
Nameplate	1	1	1	1	1
5/8" L x 1/4" W Zinc Plated Hex Bolt (7/16" Hex Head all SAE Standard Threads)	20	20	20	20	4
1/4" - 20 Hex Lock Nuts (7 / 16" Hex Head)	4	4	4	4	4
Small Lock Washers	20	20	20	20	4
#8 x 5/8" Wood Screw, Round Head with Washer, Deep Thread, with Speedpoint	4	4	4	3	0
Keys	2	2	2	2	2
Full Width Adjustable Shelves	0	0	0	3	0
Worktop Support Bracket (sold separately)	0	0	0	0	0
2.5" L X 1/4" W Cabinet Mounting Lag Bolts (7/16" Hex Head)	2	2	2	4	4
Large Mounting Fender Washers (1 1/4" Diameter with 1/4" hole in the middle)	2	2	2	7	4

WARNING:

DO NOT OVERLOAD CABINETS! CABINETS ARE DESIGNED TO CARRY THE FOLLOWING MAXIMUM WEIGHT CAPACITIES:

Cabinet	Shelf Weight Capacity (lbs)	Drawer Weight Capacity (lbs)	Bottom Weight Capacity (lbs)	Top Weight Capacity (lbs)	Overall Weight Capacity (lbs)
Locker	150	-	200	150	800
Wall	-	-	100	-	100
2 Door Base	200	-	200	200	600
Tool Drawer	-	100	-	200	500
1 Drawer, 2 Door Base	200	100	200	200	700

NEWAGE STEEL WELDED PERFORMANCE CABINETY INSTALL INSTRUCTIONS

NEWAGE
PRODUCTS INC.

ASSEMBLY INSTRUCTIONS:

INSTALL THE HEIGHT-ADJUSTABLE STEEL LEVELING LEGS:

(for all cabinets except for wall cabinet)

1. Open the cabinet and remove any loose shelves, closet rods, support brackets, etc.
2. Close / lock the cabinet drawers.
NOTE: If you need to open the cabinet / locker doors during leveler assembly, open them slowly and do not put any weight on the open doors. This avoids damage to the cabinet hinges.
3. Using two or more people, place the cabinet / locker on its back. Using supplied packaging material to cushion the cabinet to prevent any scratching of the painted surfaces.

4. One at a time line up each height-adjustable leveling leg with the corner of the cabinet. The threaded holes in the base of the cabinet should align with the holes in the leveling leg.
5. Using a 7/16th wrench hand tighten the 7/16th bolt with one lock washer into each of the pre-threaded holes. There are 4 holes to attach the leveling leg to the base of the cabinets. A minimum of two holes should be bolted to attach the leveling leg and the base of the cabinet. All four holes do not need to be secured with a bolt in order to properly attach the leveling leg.

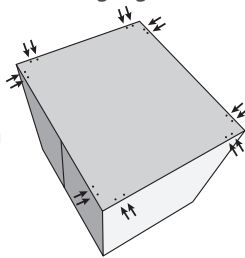

- NOTE:** Bolts should be snug. Do not over tighten or force bolts. This may result in the damaging of the threads.
6. After the leg is securely mounted to the base of the cabinet, screw on the threaded leveler by hand. Thread the leveler 95% in. This will be adjusted later on in the install.

7. Repeat steps 3 – 5 for the remaining legs.
8. Using two or more people, stand up the base cabinet and place into desired location.

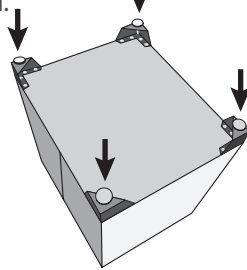

INSTALL THE CABINET HANDLES

1. Locate the holes on the front of the doors or drawers and align the correct size handles with the holes.
2. Using the supplied bolts secure the handles to the cabinets.

CABINET LEVELING

(for all cabinets except for wall cabinet)

1. Place a small magnetic level onto the top of the cabinet to verify the levelness of the cabinet.
2. If the floor slopes adjust the cabinets height-adjustable leveling legs up or down to bring the cabinet to a level position. This may require two people, one person to verify / bring cabinet level and one person to adjust the legs up and down simultaneously.
3. The base cabinet must be adjusted front to back and side to side.
4. Do not put items in the cabinet until the leveling process is complete.

FASTENING CABINETS TOGETHER:

NOTE: Base Cabinet Drawers must be removed prior to fastening cabinets together

Pull each drawer out to full extension, simultaneously depress the left lock down and right lock up in each slider while pulling out the drawer. The drawer will slide out of the tracks ready to remove. See the diagram below to note where the locks are on the drawer slides.

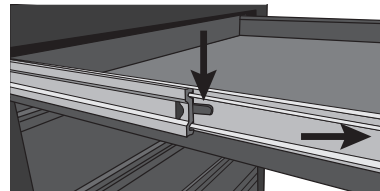

1. Locate cabinet fastening holes on the sides of each cabinet. There are black caps covering the holes. These caps must be removed first to expose the holes. Pop the caps out with a flat head screwdriver or other tool. Two holes are located at the top and bottom on the sides of each cabinet.

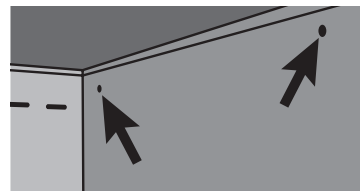

2. With your initial cabinet already securely mounted to the wall or level in place, put a 7/16" x 1/4" zinc plated hex bolt through the hole and into the same hole of the next cabinet you wish to install. Finish off the bolt by hand tightening on a 1/4" - 20 hex lock nut.

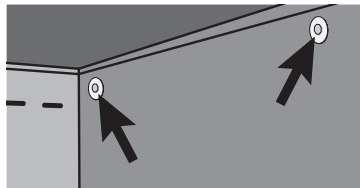

3. Repeat this step for the remaining holes.
4. Using a small magnetic level, level the second cabinet.
5. Once level using a 7/16" wrench and a 7/16" socket wrench tighten the nuts. Ensure both cabinet faces are flush prior to tightening of nuts.

INSTALLING BUTCHER BLOCK SIDE SUPPORT BRACKET:

(sold separately)

NOTE: The butcher block side support bracket is to be used in the event that a work top is added to the cabinetry system without a secondary supporting base lower cabinet. The installation of this bracket is made easier if the shelves are not yet in place, to provide more working space.

1. Open the locker doors and locate the three punched slots on either side of the locker cabinet. These slots are located 29.5" up from the inner base of the locker.



NEWAGE STEEL WELDED PERFORMANCE CABINETY INSTALL INSTRUCTIONS

NEWAGE
PRODUCTS INC.

- Determine which side of the locker you would prefer to have the butcher block top mounted
- Once side location is determined place the butcher block side support bracket on the outside of the locker by aligning the holes in the locker with the holes in the support bracket. Ensure the bracket is positioned with the side lip pointing up. See below diagram.

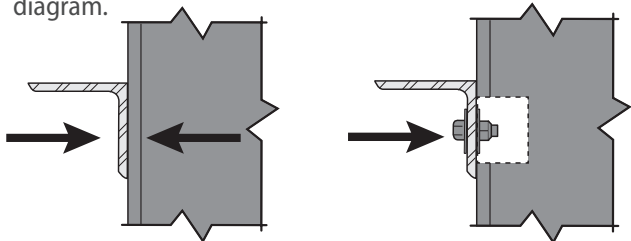

- Using the supplied hardware put a $\frac{1}{4}$ " x $\frac{5}{8}$ " bolt through the support bracket and then through the side of the locker cabinet. Once through put on a large washer and a $\frac{1}{4}$ " x 20 hex lock nut. At this point the lock nuts should be only finger tight.
- Repeat step 4 two more times for the remaining holes.
- Once all the bolts and nuts are in place level the bracket with a small magnetic level.
- Once leveled using a $\frac{7}{16}$ " wrench and a $\frac{7}{16}$ " socket wrench tighten the nuts firmly. This task may require 2 people for ease of installation.

MOUNTING OF THE BUTCHER BLOCK TOP:

(optional, for base cabinets)

NOTE: Base Cabinet Drawers must be removed prior to mounting butcher block top.

Pull each drawer out to full extension, simultaneously depress the left lock down and right lock up in each slider while pulling out the drawer. The drawer will slide out of the tracks ready to remove. See the diagram on the previous page to note where the locks are on the drawer slides.

- Place the butcher block top on top of both the base cabinet.
- Align the butcher block top so that it is flush with the side of the base cabinet.
- Using the supplied butcher block hardware fasten 4 - #10 x $\frac{7}{8}$ " Phillips head screws through the cabinet top into the butcher block top. A cordless power drill and a #2 Philips bit is required to drive the screws into the butcher block top behind the side slots.

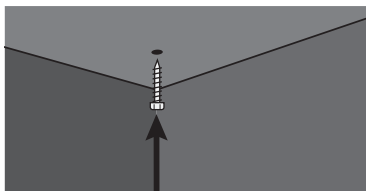

- Put drawers back into base cabinet by aligning them with the ball-bearing slides drawer tracks. The drawer should slide back into place. Push the drawer fully into the cabinet, then pull it out to full extension. If the drawer does not stop at full extension, or feels loose, the drawer has not been put back into the drawer slides properly. Ensure both drawer slides attached to the drawer are running along the drawer slides attached to the frame of the cabinet.

MOUNTING OF THE BUTCHER BLOCK TOP (optional):

NOTE: Mounting of the butcher block top requires the assembly of a base cabinet prior to the mounting of the top.

- Place the assembled base cabinet 24" away from locker with the butcher block support bracket.

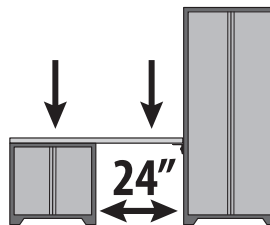

- Now place the butcher block top on top of both the butcher block support bracket and the base cabinet.

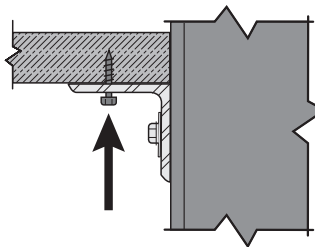

- Align the butcher block top so that it is flush with the face of the locker.
- Using the supplied butcher block hardware fasten 3 - #8 x $\frac{5}{8}$ " Phillips head screws through the bottom of the support bracket into the butcher block top. A cordless power drill and a #2 Philips bit is required to drive the screws into the butcher block top.

INSTALLING SHELVES AND CLOSET ROD:

NOTE: Shelf must be installed level with the lock on the cabinet door in order for lock to work.

- Determine the placement of the shelves.
- Tilt the shelf so that one end is higher than the other as show in the diagram below.

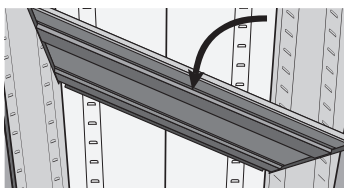

- Insert the shelf into the cabinet so that the higher end is directly above the desired slots and push the shelf down into place behind the side slots.
- Raise the lower end so it is directly above the desired slots and push the shelf down.

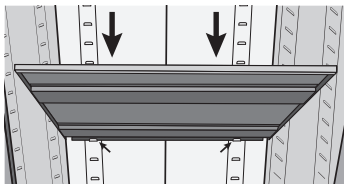

NEWAGE STEEL WELDED PERFORMANCE CABINETRY INSTALL INSTRUCTIONS

NOTE: Make sure all shelf tabs are completely in place, see below diagram.

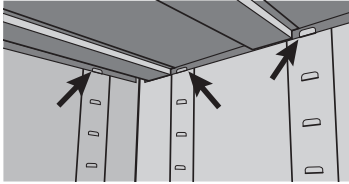

5. Repeat steps 2 – 4 for the remaining shelves.

MOUNTING CABINETS INTO DRYWALL / STUDDED WALL:

1. Using a stud finder locate the studs in the wall where the wall cabinet is to be placed.

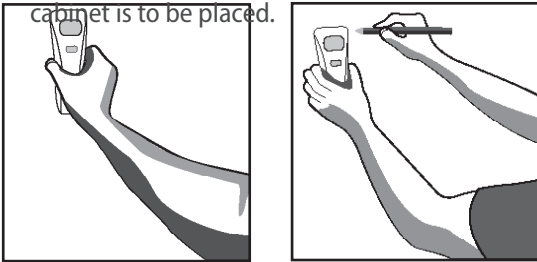

2. Once studs are located, using a pencil and a level mark a vertical line to indicate stud location.

3. Place the cabinet into position tight against the supporting wall.

4. Open the doors and locate the perforated mounting strip on the top and bottom of the backside of the cabinet.

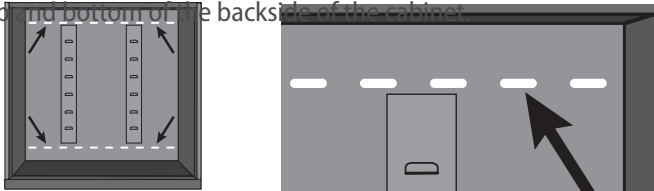

5. Align the previously marked stud lines with a perforated hole by shifting the cabinet slightly.

6. When mounting the wall cabinet use a small magnetic level on top of the cabinet and adjust the orientation of the cabinet to bring it to a level position.



7. Once leveled, using the supplied mounting hardware fasten a 2.5" x 1/4" cabinet mounting lag bolt with a large washer through the cabinet and into the stud. This can be done by hand with a 7/16" socket wrench or a cordless power drill with a 7/16" socket attachment. Do not over tighten bolts! Once the fender is sitting tightly flush with the backside of the cabinet, stop.

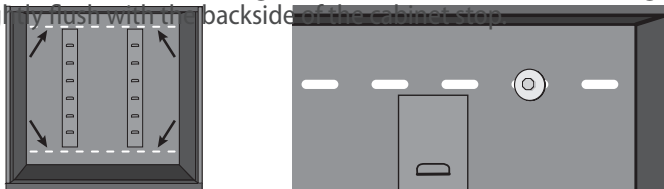

8. Repeat Step 6 three additional times with the remaining mounting hardware.

9. For mounting the tool drawer and the 1 drawer/ 2 door cabinet please refer to the "Fastening Cabinets Together" section for removing the drawers.

MOUNTING CABINETS INTO CONCRETE BLOCK / MASONRY WALL:

NOTE: Masonry Hardware **NOT** Included

REQUIRED HARDWARE:

- 2 1/4" x 1/4" Tapcon Concrete Anchor (4)
- Or
- #10 x 2" Screw with 3/16" masonry plug (4)

1. Place the wall cabinet into position tight against the supporting wall.

2. Open the doors and locate the perforated mounting strip on the top and bottom of the backside of the cabinet.

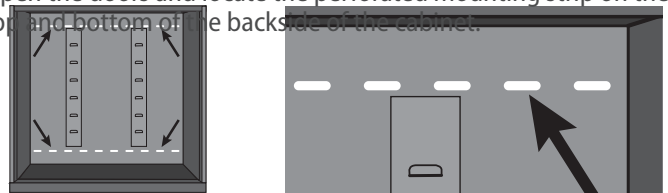

3. Place a small magnetic level on top of the wall cabinet and adjust the orientation of the cabinet to bring it to a level position.



4. Using a hammer drill, drill 4 pilot holes through the perforated strip in the backside of the cabinet and through the wall.

5. Using either the 2 1/4" x 1/4" Tapcon Concrete Anchor or #10 x 2" Screw with 3/16" masonry plug method and the supplied fender washers fasten the cabinet directly to the wall. This application requires a cordless power drill with a #2 Philips bit for ease of installation.

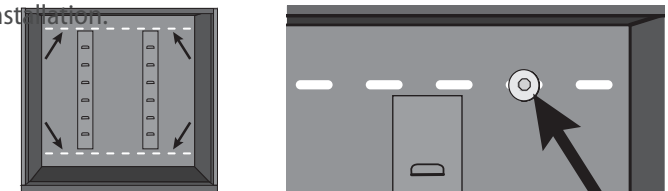

6. Repeat Step 3 - 4 three additional times with the remaining mounting hardware.

7. For mounting the tool drawer and the 1 drawer/ 2 door cabinet please refer to the "Fastening Cabinets Together" section for removing the drawers.

NEWAGE PRODUCTS INC. WELDED-STEEL CABINETS WARRANTY LIFETIME LIMITED MANUFACTURER WARRANTY



When this product is installed, operated and maintained according to the instructions attached to or furnished with the product, NewAge Products Inc. will replace the defective product or parts if the part fails as a result of defective materials or workmanship for the Lifetime of the product.

NEWAGE PRODUCTS INC. WILL NOT PAY FOR:

1. Service calls to correct the installation of any NewAge products or to instruct you how to use or install them.
 2. Damage resulting from improper handling or shipping of products, or products damaged by accident, misuse, abuse, fire, flood, improper installation, acts of God, neglect, corrosion, modification or mishandling.
 3. Products damaged by improperly loading beyond the specified maximum weight capacity outlined in the instructions provided with the product.
 4. Repairs or replacement when your product is used in other than normal, single-family household use, such as a commercial environment, or handled in any way inconsistent with the installation instructions included with the product.
 5. Cosmetic damage, including scratches, dings, dents or cracks in paint that do not affect the structural or functional capability of the product.
 6. Surfaces damaged due to chemical interaction resulting in corrosion of paint or metal.
 7. Replacement parts for NewAge products outside Canada, United States, or United Kingdom.
 8. Replacement keys or locking mechanisms.
 9. Loss of product contents due to theft, fire, flood, accident or acts of God.
 10. Shipping or freight fees to deliver replacement products or to return defective products.
 11. Any labor costs during the limited warranty period.
-
-

DISCLAIMER OF IMPLIED WARRANTIES; LIMITATION OF REMEDIES

IMPLIED WARRANTIES, INCLUDING TO THE EXTENT APPLICABLE WARRANTIES OF MERCHANTABILITY OR FITNESS FOR A PARTICULAR PURPOSE, ARE EXCLUDED TO THE EXTENT LEGALLY PERMISSIBLE. ANY IMPLIED WARRANTIES THAT MAY BE IMPOSED BY LAW ARE LIMITED TO ONE YEAR, OR THE SHORTEST PERIOD ALLOWED BY LAW. SOME STATES AND PROVINCES DO NOT ALLOW LIMITATIONS OR EXCLUSIONS ON HOW LONG AN IMPLIED WARRANTY OF MERCHANTABILITY OR FITNESS LASTS, SO THE ABOVE LIMITATIONS OR EXCLUSIONS MAY NOT APPLY TO YOU. THIS WARRANTY GIVES YOU SPECIFIC LEGAL RIGHTS, AND YOU MAY ALSO HAVE OTHER RIGHTS WHICH VARY FROM STATE TO STATE OR PROVINCE TO PROVINCE