

BB2250

Operator's manual



Please read the operator's manual carefully and make sure you understand the instructions before using the machine.

Original Instructions

English

115 32 10-95

Federal and California emission control warranty statement

YOUR WARRANTY RIGHTS AND OBLIGATIONS

The EPA (U.S. Environmental Protection Agency), CARB (California Air Resources Board), Environment Canada and Jonsered are pleased to explain the emissions control system's warranty on your 2009 and later small off-road engine. In U.S. and Canada, new equipment that use small off-road engines must be designed, built, and equipped to meet the applicable Federal or Californian stringent anti-smog standards. Jonsered must warrant the emissions control system on your small off-road engine for the period listed below provided there has been no abuse, neglect or improper maintenance of your equipment. Your emissions control system may include parts such as the carburetor, ignition system, catalytic converter, fuel tank, filters and other associated components. Also, included may be hoses, belts, connectors, sensors, and other emission-related assemblies. Where a warrantable condition exists, Jonsered will repair your small off-road engine at no cost to you including diagnosis, parts and labor.

MANUFACTURER'S WARRANTY COVERAGE

The emissions control system is warranted for two years. If any emissions-related part on your equipment is defective, the part will be repaired or replaced by Jonsered.

OWNER'S WARRANTY RESPONSIBILITIES

- As the small off-road engine owner, you are responsible for performance of the required maintenance listed in your operator's manual. Jonsered recommends that you retain all receipts covering maintenance on your small off-road engine, but Jonsered cannot deny warranty solely for the lack of receipts or your failure to ensure the performance of all scheduled maintenance.
- As the small off-road engine owner, you should however be aware that Jonsered may deny your warranty coverage if your small off-road engine or a part has failed due to abuse, neglect, or improper maintenance or unapproved modifications.
- You are responsible for presenting your small off-road engine to a Jonsered distribution center or service center as soon as the problem exists. The warranty repairs should be completed in a reasonable amount of time, not to exceed 30 days. If you have any questions regarding your warranty rights and responsibilities, you should contact your nearest authorized servicing dealer or call Husqvarna Forest & Garden at 1-800-487-5951 or visit www.charlotte.usa.jonsered.com.

WARRANTY COMMENCEMENT DATE

The warranty period begins on the date the engine or equipment is delivered to an ultimate purchaser.

LENGTH OF COVERAGE

Jonsered warrants to the ultimate purchaser and each subsequent owner that the engine or equipment is designed, built, and equipped so as to conform with all applicable regulations adopted by EPA and CARB, and is free from defects in materials and workmanship that causes the failure of a warranted part for a period of two years.

WHAT IS COVERED

REPAIR OR REPLACEMENT OF PARTS Repair or replacement of any warranted part under the warranty must be performed at no charge to the owner at a warranty station. Warranty services or repairs will be provided at all Jonsered distribution centers that are franchised to service the subject engines. Throughout the emissions warranty period of two years, Jonsered must maintain a supply of warranted parts sufficient to meet the expected demand for such parts.

WARRANTY PERIOD Any warranted part that is scheduled for replacement as required in the maintenance schedule, is warranted for the period of time prior to the first scheduled replacement point for that part. If the part fails prior to the first scheduled replacement, the part will be repaired or replaced by Jonsered at no cost. Any such part repaired or replaced under warranty is warranted for the remainder of the period prior to the first scheduled replacement point for the part. Any warranted part that is not scheduled for replacement as required in the maintenance schedule, is warranted for two years. If any such part fails during the period of warranty coverage, it will be repaired and replaced by Jonsered at no cost. Any such part repaired or replaced under the warranty is warranted for the remaining warranty period. Any warranted part that is scheduled only for regular inspection in the maintenance schedule will be warranted for a period of two years. A statement in such written instructions to the effect of "repair or replace as necessary" will not reduce the period of warranty coverage. Any such part repaired or replaced under warranty will be warranted for the remaining warranty period.

DIAGNOSIS The owner must not be charged for diagnostic labor that leads to the determination that a warranted part is in fact defective, provided that such diagnostic work is performed at a warranty station.

CONSEQUENTIAL DAMAGES Jonsered is liable for damages to other engine components proximately caused by a failure under warranty of any warranted part.

EMISSION WARRANTY PARTS LIST

- 1 Carburetor and internal parts
- 2 Intake pipe, airfilter holder and carburetor bolts.
- 3 Airfilter and fuelfilter covered up to maintenance schedule.
- 4 Spark Plug, covered up to maintenance schedule
- 5 Ignition Module
- 6 Muffler with catalytic converter
- 7 Fuel tank

WHAT IS NOT COVERED

All failures caused by abuse, neglect or improper maintenance are not covered.

ADD -ON OR MODIFIED PARTS

Add-on or modified parts that are not exempted by CARB or EPA may not be used. The use of any non-exempted add-on or modified parts will be grounds for disallowing a warranty claim. Jonsered will not be liable to warrant failures of warranted parts caused by the use of a non-exempted add-on or modified part.

HOW TO FILE A CLAIM

If you have any questions regarding your warranty rights and responsibilities, you should contact your nearest authorized servicing dealer or call Husqvarna Forest & Garden at 1-800-487-5951 or visit www.charlotte.usa.jonsered.com.

WHERE TO GET WARRANTY SERVICE

Warranty services or repairs are provided through all Jonsered authorized servicing dealers.

MAINTENANCE, REPLACEMENT AND REPAIR OF EMISSION-RELATED PARTS

Any replacement part may be used in the performance of any warranty maintenance or repairs and must be provided without charge to the owner. Such use will not reduce the warranty obligations of the manufacturer.

MAINTENANCE STATEMENT

The owner is responsible for the performance of all required maintenance, as defined in the operator's manual.



WARNING

The engine exhaust from this product contains chemical known to the State of California to cause cancer, birth defects or other reproductive harm.

Contents

Safety	4
SAFETY FIRST	4
Notes on types of warnings	4
Warning labels on the machine	4
Symbols	4
Symbols on the machine	5
Safety Precautions	5
WORKING CONDITIONS	6
WORKING CIRCUMSTANCE	6
AVOID NOISE PROBLEM	6
WORKING PLAN	6
FUEL	6
BEFORE STARTING THE ENGINE	6
USING THE PRODUCT	7
MAINTENANCE	8
TRANSPORTATION	8
STORAGE	8
What is what?	9
Technical data	10
Assembly	11
FLEXIBLE HOSE AND SWIVEL JOINT	11
CONTROL HANDLE	11
CABLING	11
BLOW PIPES	11
HARNES	11
Fuel	12
FUEL	12
HOW TO MIX FUEL	12
FUELING THE UNIT	12
Operation	13
STARTING ENGINE	13
ADJUSTING IDLE SPEED	14
STOPPING ENGINE	14
Maintenance	15
AIR CLEANER	15
FUEL FILTER	15
SPARK PLUG	16
MUFFLER	16
SPARK ARRESTER	16
COOLING SYSTEM	16
AIR INLET NET	17
SHOLDER STRAP	17
Storage	17

Safety

SAFETY FIRST

Instructions contained in warnings within this manual and warning seals marked with a  symbol on the blower concern critical points which must be taken into consideration to prevent possible serious bodily injury, and for this reason you are requested to read all such instructions carefully and follow them without fail.

Notes on types of warnings

WARNING

Instructions labeled as shown above, concern critical steps or procedures which must be followed in order to prevent accidents which could lead to serious bodily injury or death. This mark is used to indicate instructions which must be followed without exception.

IMPORTANT

Instructions labeled as shown above concern steps or procedures which, if not followed correctly, could lead to mechanical failure, breakdown, or damage.

NOTE

Used to label supplementary instructions designed to provide hints or directions useful in the use of the product.

Warning labels on the machine

Symbols

WARNING! The machine can be a dangerous tool if used incorrectly or carelessly, which can cause serious or fatal injury to the operator or others.



Please read the operator's manual carefully and make sure you understand the instructions before using the machine.



Always wear:

- Hearing protection
- Approved eye protection



Always wear protective gloves.



The blower can forcibly throw objects that can bounce back. This can result in serious eye injuries if the recommended safety equipment is not used.



The blower operator must make sure that no bystanders or animals come nearer than 50 feet (15 meters). Whenever several operators are working in the same work area, they should maintain a safe distance of at least 50 feet (15 meters) from one another.



A breathing mask should be used when there is a risk of dust.



Keep all parts of your body away from hot surfaces.



Other symbols/decals on the machine refer to special certification requirements for certain markets.

IMPORTANT

If the warning label peels off or becomes soiled and impossible to read, you should contact the dealer from which you purchased the product to order new labels and affix them in the required location(s).

Symbols on the machine



For safe operation and maintenance, symbols are carved in relief on the machine. Using to these indications, please be careful not to make a mistake.

(a) The port to refuel the "MIX GASOLINE"
Position: FUEL TANK CAP

(b) The direction to close the choke
Position: CLEANER BODY

(c) The direction to open the choke
Position: CLEANER BODY

(d) The direction to stop the engine
Position: CONTROL HANDLE

<For EPA & CARB>

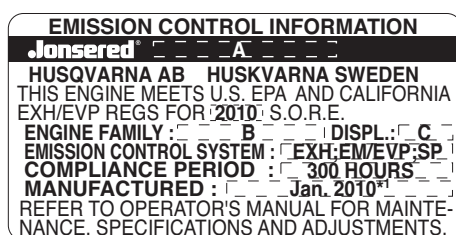

*1: THE ACTUAL MANUFACTURING MONTH WILL BE PRINTED.

A: MODELL	B: ENGINE FAMILY	C: ENGINE DISPLACEMENT
BB2250	9HQZS.0505BP*2	50cc

*2: THE INITIAL CODE WILL BE CHANGED EVERY YEAR OF MANUFACTUREING

This engine label certifies that the product is certified in accordance with American exhaust emissions requirements EPA Ph III and Californian exhaust and evaporative emissions requirements CARB Tier III. The Emissions Compliance Period referred to on the emissions compliance label indicates the number of operating hours for which the engine has shown to meet Federal and Californian emission requirements.

Safety Precautions

⚠ WARNING

1. Read this Blower Operator Manual carefully. Be sure you understand how to operate this unit properly before you use it. Failure to do so could result in serious injury.
2. Be sure to keep this manual handy so that you may refer to it later whenever any questions arise. Also note that you are requested to contact the dealer from whom you purchased the product for assistance the event that you have any questions which cannot be answered herein.
3. Always be sure to include this manual when selling, lending, or otherwise transferring the ownership of this product.
4. Do not lend or rent your machine without the owner's manual.
5. Be sure that anyone using your unit understands the information contained in this manual.
6. Never let a child use the machine.

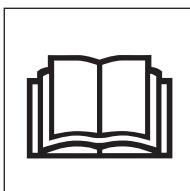

7. Long-term exposure to noise can result in permanent hearing impairment. So always use approved hearing protection.
8. Under no circumstances may the design of the machine be modified without the permission of the manufacturer. Always use genuine accessories. Non-authorized modifications and/or accessories can result in serious personal injury or the death of the operator or others.
9. A blower is a dangerous tool if used carelessly or incorrectly and can cause serious, even fatal injuries. It is extremely important that you read and understand the contents of this Operator's manual.
10. Jonsered has a policy of continuous product development and therefore reserves the right to modify the design and appearance of products without prior notice.
11. The machine is only designed for blowing lawns, pathways, asphalt roads and the like.

Safety Precautions

WORKING CONDITIONS

1. Refrain from operating the blower if you are tired, ill, or upset, or if you are under the influence of alcohol, drugs or medication
2. To reduce the risk of hearing loss associated with sound levels, hearing protection is required.
3. To reduce the risk of injury associated with thrown objects, always wear eye protection and foot protection. Approved protective goggles must comply with standard ANSI Z87.1 in the USA or EN 166 in EU countries.



4. To reduce the risk of injury associated with the inhalation of dust, use a face filter mask in dusty conditions.
5. Wear rubber-soled shoes or shoes with some other form of anti-slip protection to help protect you against falling.



6. To reduce the risk of injury associated with objects being drawn into rotating parts, do not wear loose clothing, scarves, neck chains, hair longer than shoulder length, or other loose material.



7. Prolonged use of a blower, exposing the operator to vibrations and cold, may produce whitefinger disease (Raynaud's phenomenon), the symptoms of which include tingling and burning sensations followed by loss of color and numbness in the fingers. All factors which contribute to whitefinger disease are not known, but cold weather, smoking diseases or physical conditions as well as long periods of exposure to vibration are mentioned as factors. In order to reduce the risk of whitefinger disease, the following precautions are strongly recommended

- a) Keep your body warm. Never use the blower during rain.
- b) Take more than 5 minutes of break in a warm place frequently.
- c) Maintain a firm grip at all times, but do not squeeze the handles with constant, excessive pressure.
- d) If you feel discomfort, redness and swelling of your fingers or any other part of your body, see a doctor before it gets worse.

8. This machine produces an electromagnetic field during operation. This field may under some circumstances interfere with active or passive medical implants. To reduce the risk of serious or fatal injury, we recommend persons with medical implants to consult their physician and the medical implant manufacturer before operating this machine.

WORKING CIRCUMSTANCE

1. To reduce the risk of injury associated with exhaust fume inhalation, do not operate in unventilated area. The exhaust gases contain harmful carbon monoxide.
2. Avoid using the blower where stable footing and balance are not assured.
3. Never operate the machine in high wind, bad weather, potentially explosive atmosphere, when visibility is poor or in very high or low temperatures. (Our recommended use environment is below 40 degrees C (104 degrees F).)

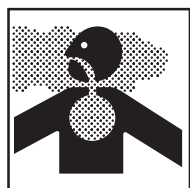

AVOID NOISE PROBLEM

NOTE

Check and follow the local regulations as to sound levels and hours of operations for blower.

1. Operate power equipment only at reasonable hours, not early in the morning or late at night when people might be disturbed. Comply with times listed in local ordinances.
2. To reduce sound levels, limit the number of pieces of equipment used at any one time.
3. Operate power blowers at the lowest possible throttle speed to do the job.
4. Check your equipment before operation, especially the muffler, air intakes and air filters.

WORKING PLAN

To reduce the risk of health damages, avoid excessive use and take sufficient time to rest.

FUEL

WARNING

To reduce the risk of fire and burn injury:

- a) Handle fuel with care. It is highly flammable.
- b) Do not smoke while handling fuel.
- c) Do not refuel a hot engine.
- d) Do not refuel a running engine.
- e) Avoid spilling fuel or oil. Always wipe unit dry before using.
- f) Move at least 10 ft. (3 meters) away from the fueling point before starting the engine.
- g) Always store gasoline in a container approved for flammable liquids.
- h) Make sure the unit is properly assembled and in good operating condition.
- i) Do not use the blower near a fire, as aiming the blower in the direction of a flame may cause flammable substances to ignite.



BEFORE STARTING THE ENGINE

Each time before starting the engine, inspect the entire unit to see if every part is in good order and is securely tightened in place. If any damage is found in the fuel line, the exhaust line, or the ignition wiring, do not use the blower until it has been repaired.

IMPORTANT

Before starting operation, always make sure to check if any obstacles are left inside the volute case and net. The obstacles may cause serious injury or damage to fan and volute case.



Safety Precautions

⚠ WARNING

Check to see if the shock-absorbers have become cracked or otherwise damaged. Note that failing to replace these rubber and spring mounts when they have become cracked or damaged may cause the engine to come loose from its frame during use, thus resulting in possible serious bodily injury.

If cracked, be sure to replace without delay.

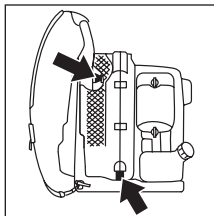

⚠ WARNING

To reduce the risk of injury associated with contacting rotating parts, stop the engine before installing or removing attachments. Never take off the Guard Net. Always disconnect the spark plug before performing maintenance or accessing movable parts.

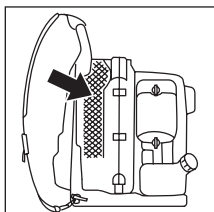

USING THE PRODUCT

⚠ WARNING

While using the product, if abnormal noise or vibration occurs, stop the engine immediately and contact the nearest Jonserved servicing dealer for assistance. Checking the fan is very important. If the rotating fan should break up, it might lead to serious accidents.

1. This blower is a backpack type, and is shouldered while operating. It is operated and controlled with the handle on the tube by right hand.
2. Check the work area that the blower will be used in and remove or cover all valuables that may be damaged by the air blast or thrown debris.
3. Make sure you can move and stand safely. Check the area around you for possible obstacles (roots, rocks, branches, ditches, etc.) in case you have to move suddenly. Take great care when working on sloping ground.

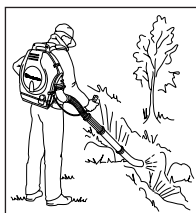

4. To reduce the risk of injury associated with thrown objects.
 - a) Watch out for children, pets, open windows or freshly washed cars, and blow debris safely away.
 - b) Use the full blower tube extension so the air stream can work close to the ground.
 - c) Do not allow bystanders in work area.
 - d) Do not point the blower tube in the direction of people or pets.
 - e) Always check to be sure that no debris has been blown onto someone else's property.
 - f) Pay attention to the direction of the wind, do not work against the wind.
5. To minimize blowing time.
 - a) Use rakes and brooms to loosen debris before blowing.
 - b) In dusty conditions, slightly dampen surfaces or use a mister attachment when water is available.
 - c) Conserve water by using power blowers instead of hoses for many lawn and garden applications, including areas such as gutters, screens, patios, grills, porches and gardens.
6. The blower must not be used while on a ladder or scaffolding.

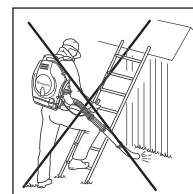
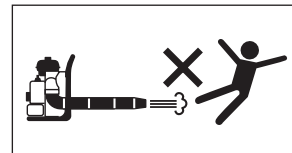

7. Never put the machine down with the engine running unless you have it in clear sight.
8. Never touch the spark plug or plug cord while the engine is in operation. Doing so may result in being subjected to an electrical shock.
9. Never touch the muffler, spark plug, or other metallic parts of the engine, or area around the engine cover while the engine is in operation or immediately after shutting down the engine. These metallic parts reach high temperatures during operation and doing so could result in serious burns.

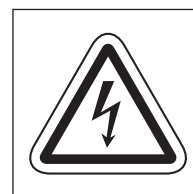

⚠ WARNING

The temperature of the machine may increase after stopping the engine. Especially never forget to cool down the engine before refueling the machine.

10. In an emergency, pull up the lower portion of both strap buckles to loosen the straps. Move yourself away from the unit.
11. After using blowers and other equipment, CLEAN UP! Dispose of debris in trash receptacles.



Safety Precautions

MAINTENANCE

1. In order to maintain your product in proper working order, perform the maintenance and checking operations described in the manual at regular intervals.
2. Always be sure to turn off the engine and disconnect the spark plug before performing any maintenance or checking procedures.

WARNING

The metallic parts, engine cover, and area around the engine reach high temperatures immediately after stopping the engine.

3. Examine the blower at intervals for loose fasteners and rusted or damaged parts. Use special care around the fuel line, the muffler, and the ignition wiring.
4. All engine service except for those described in this manual should be performed by competent service personnel. Improper service to the blower fan and muffler could cause a hazardous failure.
5. When replacing the any other part or any lubricant, always be sure to use only Jonsered products or products which have been certified by Jonsered for use with the Jonsered product.
6. In the event that any part must be replaced or any maintenance or repair work not described in this manual must be performed, please contact the nearest Jonsered servicing dealer for assistance.
7. Do not use any accessory or attachment other than those bearing the Jonsered mark and recommended for the unit.
8. Under no circumstances should you ever take apart the product or alter it in any way. Doing so might result in the product becoming damaged during operation or the product becoming unable to operate properly.

TRANSPORTATION

- Drain the fuel from the fuel tank before transporting or storing the blower.
- Secure the blower so that it does not receive damage from shock during transportation.
- Do not apply strong forces to the blower, such as throwing it or dropping it. Doing so invalidates the warranty.

STORAGE

- When storing the blower, choose a space indoors, dry, cool and dark, well-ventilated, free from dust and out of the reach of children.

What is what?

<BB2250>

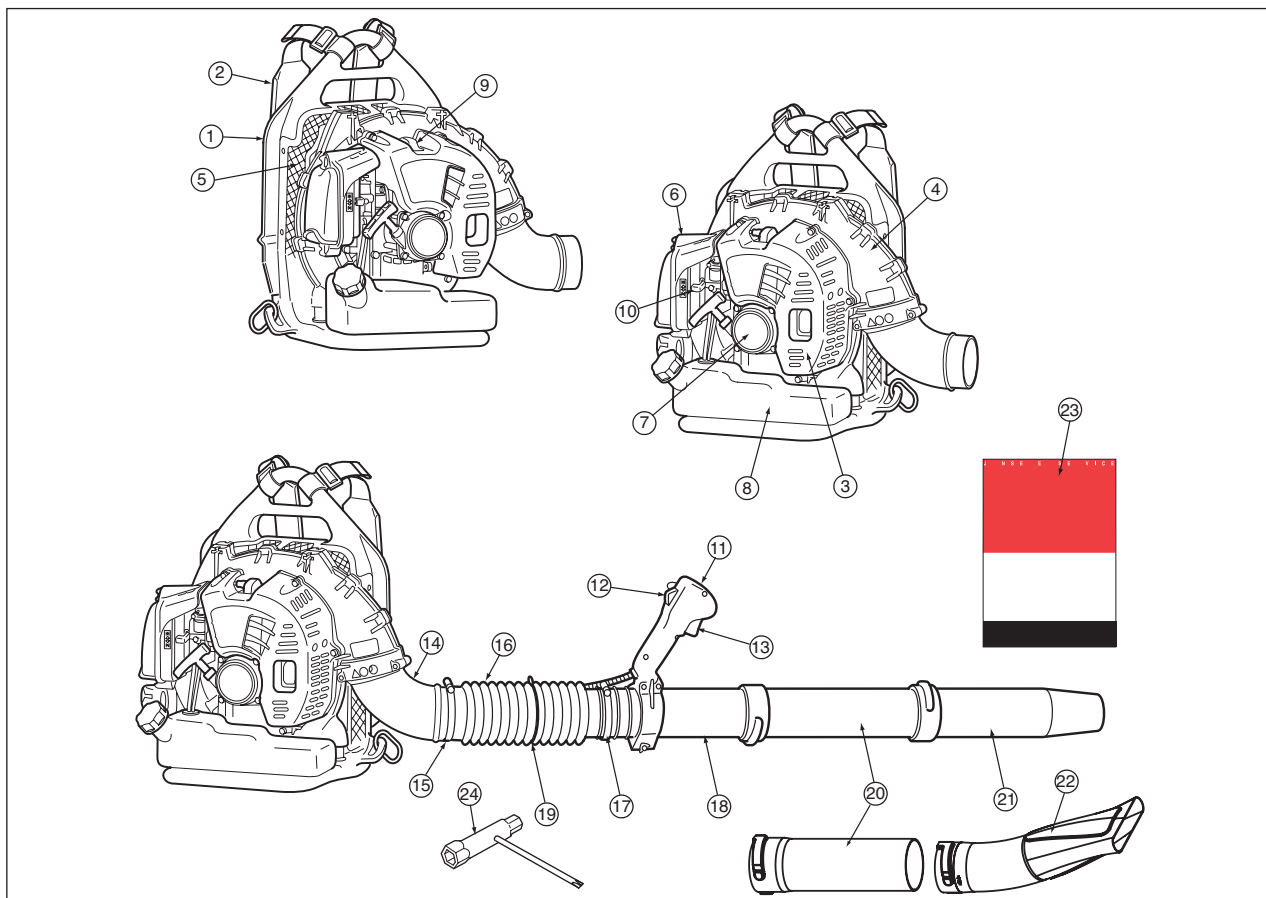

- | | |
|-----------------------|-------------------------|
| 1. Frame | 13. Throttle Lever |
| 2. Harness | 14. Elbow |
| 3. Engine Cover | 15. Clamp (large) |
| 4. Volute Case, Cover | 16. Flexible hose |
| 5. Net | 17. Clamp (small) |
| 6. Air Cleaner | 18. Swivel joint |
| 7. Recoil Starter | 19. Clamp (for cabling) |
| 8. Fuel Tank | 20. Blow pipe |
| 9. Spark Plug Cap | 21. Pipe end |
| 10. Choke Lever | 22. Flat nozzle |
| 11. Control handle | 23. Operator's manual |
| 12. Stop Switch | 24. Combination spanner |

DISPOSAL

When disposing your machine, do not disassemble the machine.

When disposing your machine, fuel or oil for the machine, be sure to follow your local regulations.

Frame:	PE (Polyethylene)
Harness:	Chemical fiber
Throttle lever:	Metal, Plastic
Volute case, Volute cover, Engine cover:	PA66GF (Glass-reinforced nylon), Brass
Pad:	Chemical fiber
Flexible hose:	EVA (Ethylene vinyl acetate)
Pipes:	PP (Polypropylene), PE (Polyethylene)
Fan:	PA66GF (Glass-reinforced nylon)
Element:	Urethane

* The insert nut of volute case and fan can be taken off.

Technical data

MODEL	BB2250
Dimensions (L x W x H) mm	401x460x495
Dry Weight (including pipes) kg	10.1
Dry Weight (without accessories) kg	9.4
Fuel Tank Capacity liter	2.1
Engine Type	Air cooled 2-cycle gasoline engine
Piston Displacement cu. cm	50.2
Air Filter	Half wet urethane
Carburetor (Diaphragm) valve type	Rotary
Ignition System	Digital IgnitionI
Spark Plug	NGK CMR7H
Muffler	Spark arrester equipped
Idle speed rpm	2000
Operating Engine Speed rpm	2000 to 6000
Fuel Consumption liter/h	1.05
Air Volume (round Pipe) cu. m/min	11,5
Air Volume (@ housing) cu. m/min	18,9
Air velocity m/sec (Maximum)	85
Noise emissions (see note 1)	
Sound power level, measured dB(A)	103
Sound power level, guaranteed L_{WA} dB(A)	104
Sound levels (see note 2)	
Equivalent sound pressure level at the operator's ear, measured according to EN15503 dB(A)	89
Vibration levels (see note 3)	
Equivalent vibration levels (a_{hveq}) at handle, measured according to EN15503 m/s^2	1,4

- The data shown above are those in the case of one straight pipe and round pipe.
- Specifications are subject to change without notice.
- This spark ignition system complies with the Canadian standard ICES-002.

Note 1: Noise emissions in the environment measured as sound power (L_{WA}) in conformity with EC directive 2000/14/EC. Reported sound power level for the machine has been measured with the original attachment that gives the highest level. The difference between guaranteed and measured sound power is that the guaranteed sound power also includes dispersion in the measurement result and the variations between different machines of the same model according to Directive 2000/14/EC.

Note 2: The equivalent sound pressure level value is calculated with a work cycle of a duration of 1/7 for idling and 6/7 for racing. Reported data for equivalent sound pressure level for the machine has a typical statistical dispersion (standard deviation) of 1 dB(A).

Note 3: The equivalent vibration total value is calculated with a work cycle of a duration of 1/7 for idling and 6/7 for racing. Reported data for equivalent vibration level has a typical statistical dispersion (standard deviation) of 1 m/s^2 .

Assembly

■ FLEXIBLE HOSE AND SWIVEL JOINT

1. Connect the blower and swivel joint with flexible hose. Clamp both ends of the flexible hose securely with the hardware supplied with the unit.

(1) Flexible hose (2) Swivel joint
(3) clamp (large) (4) Clamp (small)

NOTE

A light lubricant may be used to ease assembly of flexible hose to blower tube.

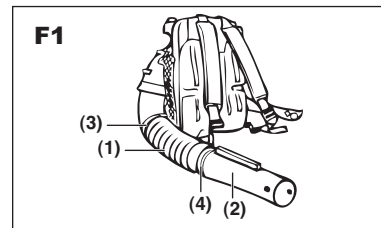

■ CONTROL HANDLE

1. Set up the handle holder to the swivel joint and tighten the screw on the holder. When setting up the handle holder, please make sure to match the handle holder to the convex on the swivel joint as shown in F2.
2. Adjust the position to achieve a comfortable working position, and tighten the control handle.

(1) Handle holder
(2) Swivel joint
(3) Screw

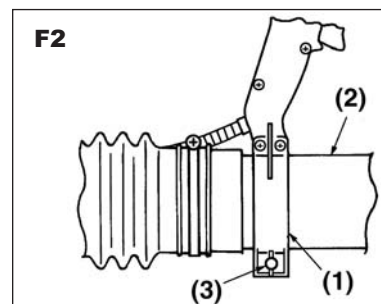

■ CABLING

- Use the clamp to fasten the cabling to the flexible hose.

(1) Clamp
(2) Cabling
(3) Flexible hose

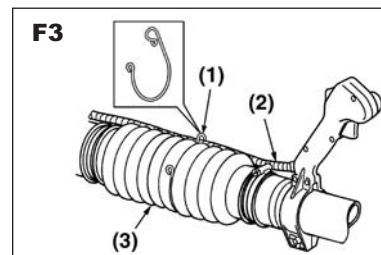

■ BLOW PIPES

Connect the straight pipe and pipe end. Push the pipes together and turn them so they lock in relation to one another until the connection is locked.

NOTE

A light lubricant may be used to ease assembly of the blower tube.

NOTE

If longer tube is required, the second straight pipe can be connected with the first one.

If higher air speed is required, the round blow pipe can be replaced by the flat nozzle with the second straight pipe.

(1) Flat nozzle.

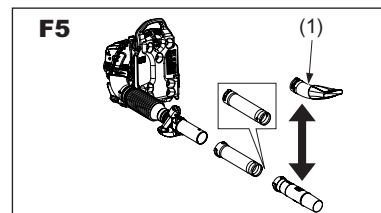
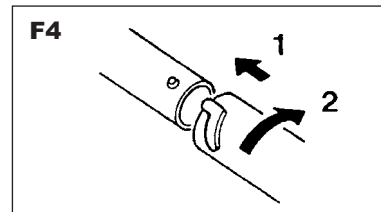

■ HARNESS

WARNING

The harness must always be worn when working with the machine. Failure to do so means you will be unable to maneuver safely and this can result in injury to yourself or others.

A correctly adjusted harness and machine significantly facilitates the work. Adjust the harness to give the best working position.

Tighten the side straps so that the pressure is evenly distributed across the shoulders.

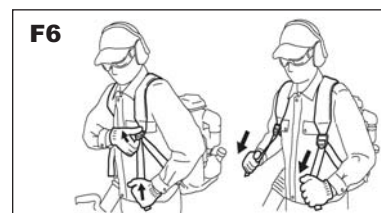

Fuel

FUEL

⚠ WARNING

- Gasoline is very flammable. Avoid smoking or bringing any flame or sparks near fuel. Make sure to stop the engine and allow it cool before refueling the unit. Select outdoor bare ground for fueling and move at least 10ft (3m) away from the fueling point before starting the engine.
- The engines are lubricated by oil specially formulated for air-cooled 2-cycle gasoline engine use. If Jonsered oil is not available, use an anti-oxidant added quality oil expressly labeled for air-cooled 2-cycle engine use. (JASO FC GRADE OIL or ISO EGC GRADE)
- Do not use BIA or TCW (2-stroke water-cooling type) mixed oil.

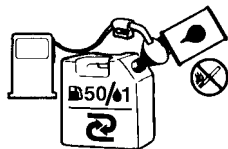

RECOMMENDED MIXING RATIO GASOLINE 50:OIL 1

- Exhaust emission are controlled by the fundamental engine parameters and components (i.e., carburation, ignition timing and port timing) without addition of any major hardware or the introduction of an inert material during combustion.
- These engines are certified to operate on unleaded gasoline.
- Make sure to use gasoline with a minimum octane number of 89 RON (USA/Canada: 87AL)
- If you use a gasoline of a lower octane value than specified, there is a danger that the engine temperature may rise and an engine problem such as piston seizing may consequently occur.
- Unleaded gasoline is recommended to reduce the contamination of the air for the sake of your health and the environment.
- Poor quality gasolines or oils may damage sealing rings, fuel lines or fuel tank of the engine.

HOW TO MIX FUEL

⚠ IMPORTANT

Pay attention to agitation.

- Measure out the quantities of gasoline and oil to be mixed.
- Put some of the gasoline into a clean, approved fuel container.
- Pour in all of the oil and agitate well.
- Pour in the rest of gasoline and agitate again for at least one minute. As some oils may be difficult to agitate depending on oil ingredients, sufficient agitation is necessary for the engine to last long. Note that, if the agitation is insufficient, there is an increased danger of early piston seizing due to an abnormally lean mixture.
- Indicate the contents on outside of container for easy identification to avoid mixing with raw gasoline or other containers.

FUELING THE UNIT

- Untwist and remove the fuel cap.
- Put fuel into the fuel tank to 80% of the full capacity.
- Fasten the fuel cap securely and wipe up any fuel spillage around the unit.

⚠ WARNING

- Select bare ground for fueling.
- Move at least 10 feet (3 meters) away from the fueling point before starting the engine.
- Stop the engine and let it cool for a few minutes before refueling the unit. At that time, be sure to sufficiently agitate the mixed gasoline in the container.
- Do not smoke or place hot objects near fuel.

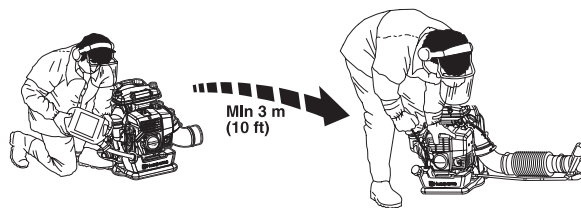

FOR YOUR ENGINE LIFE, AVOID;

- FUEL WITH NO OIL (RAW GASOLINE) - It will cause severe damage to the internal engine parts very quickly.
- GASOHOL - It can cause deterioration of rubber and/or plastic parts and disruption of engine lubrication.
- OIL FOR 4-CYCLE ENGINE USE - It can cause spark plug fouling, exhaust port blocking, or piston ring sticking.
- Mixed fuels which have been left unused for a period of one month or more may clog the carburetor and result in the engine failing to operate properly.
- When storing the product for a long period of time, clean the fuel tank after rendering it empty. Next, activate the engine and empty the carburetor of the composite fuel.
- When scrapping the used mixed oil container, scrap it only at an authorized repository site.

📖 NOTE

For details of quality assurance, read the description in the Warranty section carefully. Moreover, normal wear and change in product with no functional influence are not covered by the warranty. Also, note that if the usage in the instruction manual is not observed for the mixed gasoline, etc. as described herein, it may not be covered by the warranty.

Operation

■ STARTING ENGINE

! IMPORTANT

- **Avoid operating the blower with the flexible tube and swivel joint disconnected. That will reduce the cooling air and the engine could be damaged by overheating.**

1. Push the primer bulb until fuel flows out in the clear tube.
2. When the engine is cool, close the choke.

- (1) Choke Lever
 (2) Primer Bulb
 (3) OPEN
 (4) CLOSE

3. Set the stop switch to the start position.
4. Set the throttle lever position in about 1/3 open position.

- (1) Full Throttle
 (2) About 1/3 Open
 (3) Idling
 (4) Stop switch

5. To start, hold the top of the blower firmly with your left hand. Pull the starter knob slowly until you feel it engage and then give it a vigorous strong pull.

! IMPORTANT

- **Never twist the starter cord around your hand.**
- **Avoid pulling the starter rope out to its full extent and allowing the starter rope to snap back. This will prevent premature damage to the starter.**
- **Do not let a person stand near the blower or the exhaust port.**

6. Once the engine is running, gradually open the choke if it was set closed, and let the engine run at idle speed for a minute to warm it up.

📖 NOTE

When the engine fails to start after several attempts due to overchoking, open the choke and repeat pulling the rope.

⚠ WARNING

Air comes out as soon as the engine is started, even at idle speed.

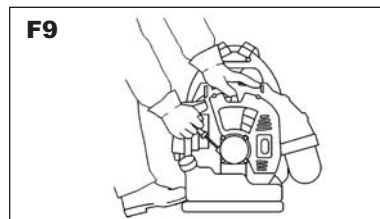
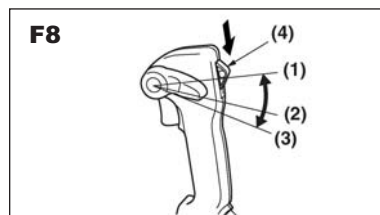
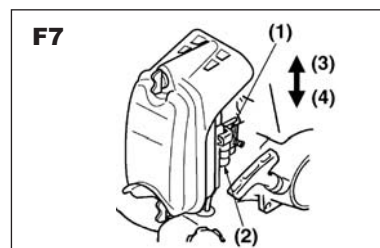

Operation

■ ADJUSTING IDLE SPEED

- The idling speed is set for 2000 rpm at the factory. If it is necessary to adjust the idle speed, use the adjustment screw on the top side of carburetor.

(1) Idling Adjustment Screw

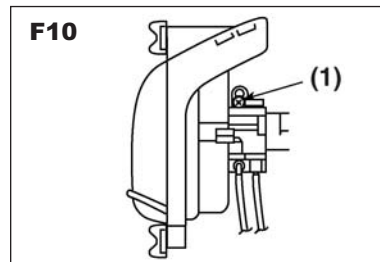

■ STOPPING ENGINE

- Move the throttle lever to the idling position and set the stop switch to the stop position.

(1) Stop switch

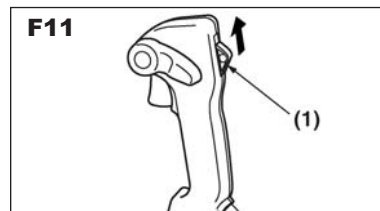

NOTE

If the engine does not stop when setting the stop switch to the stop position, close the choke lever and stop the engine.

In this case, please repair the machine at your nearest servicing dealer.

(1) Choke Lever

(2) OPEN

(3) CLOSE

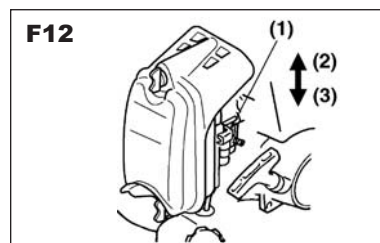

Maintenance

Maintenance, replacement, or repair of the emission control device and systems may be performed by any non-road engine repair establishment or individual.

System/Component	Procedure	Daily or Before use	Every 25 hours after	Every 50 hours after	Every 100 hours after
Air Filter	Inspect/Clean		x		
Fuel Leaks	Inspect/Replace	x			
Fuel Filter	Inspect/Replace	x	x		
Fuel Line	Inspect/Clean	x			
Spark Plug	Inspect/Clean		x		
Muffler	Inspect/Clean	x			
Bolts on muffler	Tighten	x			
Entire unit	Inspect/Replace	x			
Muffler Spark Arrester	Inspect/Clean			x	
Cooling System	Inspect/Clean	x			
Screws/Nuts/Bolts	Tighten	x			
Cylinder Exhaust Port	Inspect/Clean				x

⚠ WARNING

Make sure that the engine has stopped and is cool before performing any service to the blower. Contact with rotating blower fan or hot muffler may result in a personal injury.

■ AIR CLEANER

- Check the air cleaner before use.
A clogged air filter may increase fuel consumption while cutting down the engine power.
- Never operate the blower without an air filter or with a deformed or broken filter element because unfiltered dusty air will quickly ruin the engine.

CLEANING AIR FILTER:

1. Unscrew the 2 knobs and remove the air cleaner cover.
2. Wash the filter element with neutral detergent and warm water and then dry completely. (Wash the filter once a week)
3. Moisten the filter element with a small amount of 2 cycle oil.

📖 NOTE

- Do not apply 4 cycle motor oil as they may damage element.
 - Do not use mixture gasoline. This type of gasoline does not contain much of oil, so that the element becomes dry after a few hours.
4. Reinstall the element into the packing, set the packing into the air cleaner body. Never forget to attach the screen properly. If the screen is not attached, the cleaner will not seal properly and the dusts come into the cylinder.
 5. Reinstall the air cleaner cover and screw the 2 knobs.

- (1) Air Cleaner Cover (2) Screen
(3) Cleaner Body (4) Element
(5) Packing

F13

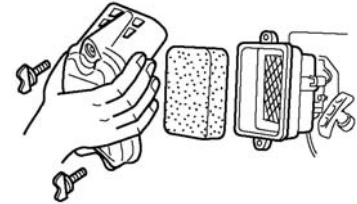

F14

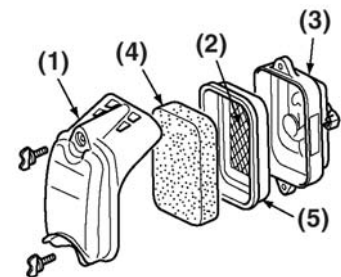

■ FUEL FILTER

- A clogged fuel filter may cause poor acceleration of the engine. Check periodically to see if the filter is clogged with dirt. The filter can be taken out of the fueling port using a small wire hook. Disconnect the filter assembly from the fuel pipe and unhook the retainer to disassemble it. Clean the components with gasoline.

- (1) Screen (2) Element (x 2)
(3) Holder (4) Retainer

F15

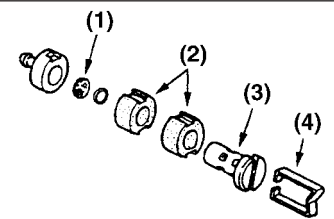

Maintenance

■ SPARK PLUG

- The spark plug may gather carbon deposits on its firing end with reasonable use. Remove and inspect the spark plug every 25 hours and clean the electrodes as necessary with a wire brush. The spark gap should be adjusted to .025 in (0.6 to 0.7mm).
- Plug manufacturers recommend replacing the plug twice a year to avoid unexpected plug failure in a job.
REPLACEMENT PLUG IS A NGK CMR7H.

! IMPORTANT

- **Note that using any spark plugs other than those designated may result in the engine failing to operate properly or in the engine becoming overheated and damaged. Check that the spark plug is fitted with a suppressor.**
- **To install the spark plug, first turn the plug with your hands until it is tight, then tighten it a quarter turn more with a socket wrench.**

■ MUFFLER

! WARNING

- **Periodically inspect the muffler for loose fasteners, damage or corrosion. If any sign of exhaust leakage is found, do not use the blower and have it repaired immediately.**
1. Remove the muffler, insert a screwdriver into the vent, and wipe away any carbon buildup. Wipe away any carbon buildup on the muffler exhaust vent and cylinder exhaust port at the same time.
 2. Tighten all screws, bolts, and fittings.

■ SPARK ARRESTER

- The muffler is equipped with a spark arrester to prevent red hot carbon from flying out of the exhaust outlet. Periodically inspect and clean as necessary with a wire brush.

- | | |
|--------------------|--------------|
| (1) Bolt | (2) Bolt |
| (3) Spark Arrester | (4) Diffuser |

! WARNING

- **Before starting operation, always make sure to check if the muffler is properly held by the bolts (2).**
Fastening Torque: 8 to 12 N·m
- **Also make sure that the spark arrester and the diffuser are properly attached with the bolts (1). (Fastening Torque : 2 to 3 N·m)**

■ COOLING SYSTEM

- To keep the working temperature as low as possible the machine is equipped with a cooling system.

(1) Cooling fins on the cylinder.

- Clean the cooling system with a brush once a week, more often in demanding conditions. A dirty or blocked cooling system results in the machine overheating which causes damage to the piston and cylinder.

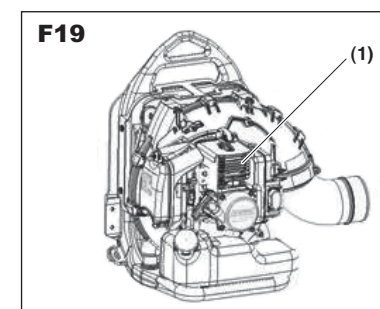
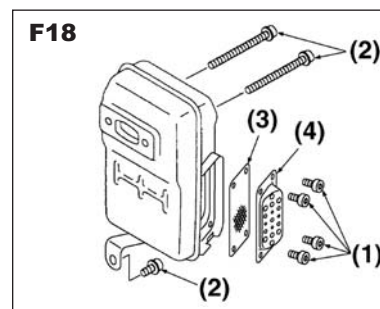
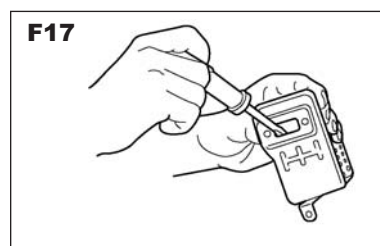
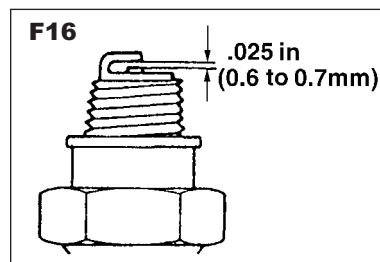

Maintenance

■ AIR INLET NET

⚠ IMPORTANT

- Blown air is taken in from the air inlet net. If the air flow drops during operation, stop the engine and inspect the air inlet net for blockage by obstacles.
- Note that failure to remove any such obstacles may result in the engine becoming overheated and damaged.

(1) Net

⚠ WARNING

Never use the blower without the net on the blower. Before each use, check that the net is attached in place and is free from any damage.

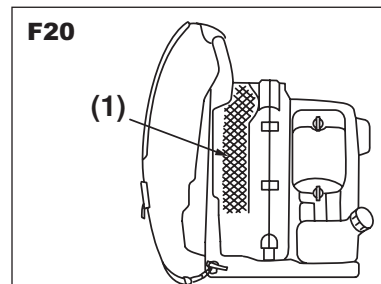

■ SHOULDER STRAP

- If the shoulder strap is damaged it may break during use, thus causing the product to fall and resulting in personal injury. Follow the instructions below to replace the shoulder strap with new one.
- Pass the upper end of the strap through the hanger, making the FLAPPED SIDE OUTSIDE.
- Put the end of the strap through the ring on the strap, and then push the ring toward the hanger as close as possible.

(1) Ring

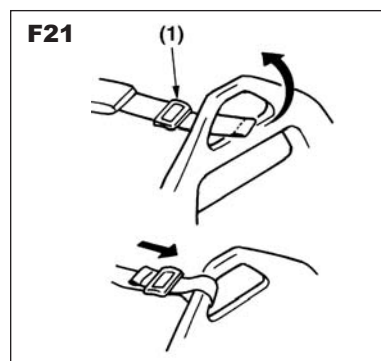

Storage

BEFORE STORING THE BLOWER:

1. Drain the fuel tank and push the primer bulb until it becomes empty of fuel.
2. Remove the spark plug and drop a spoonful of 2-cycle oil into the cylinder. Crank the engine several times and install the spark plug.
3. Store unit in a dry, cool and dark, well-ventilated, dust-free place, out of the reach of children.