

# Tank Installation

## Components

When you purchase the Instant Hot Water tank, contents include:

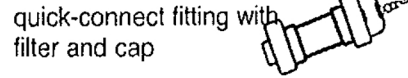
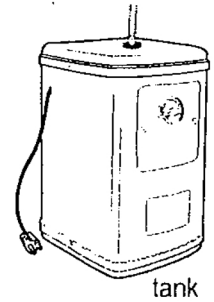
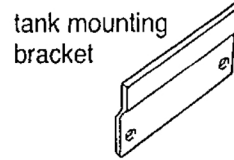
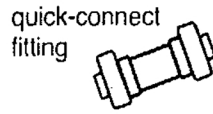

## Materials required (not provided)



2 mounting bracket screws  
(and 2 plastic anchors if attaching to drywall)

1/4" (6.4 mm)  
O.D. copper  
tubing.

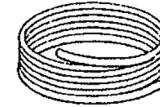

Shut-Off valve  
and "T" fitting

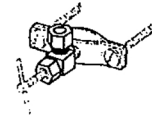
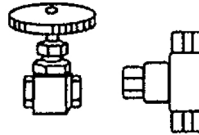

Saddle valve kit to fit  
water supply line.

(Connections must meet all local codes and ordinances.)

## Tools and Safety Equipment you may need (not provided)

- ruler or measuring tape
- pliers
- hand or electric drill
- small drill bit for starter holes
- 13/8" drill bit - if no sink hole exists
- safety glasses
- bucket or pan
- open-end wrench(es)
- gloves
- tubing cutter

## Faucet Compatibility

**Only "Open Vent" faucets function with a instant hot water dispenser tank.  
Connecting a standard faucet will damage the tank and void the warranty.**

## IMPORTANT INFORMATION

This hot water dispenser produces instant hot water of approximately 190°F (88°C) as dispensed from the faucet.

This product is not intended to produce a continuous flow of hot water. The standard model will produce up to 60 cups of water per hour at approximately 190°F (88°C). Due to high water temperature, for safety reasons, the tank is not under pressure. Consequently, there is a slight delay of water flow after the faucet has been activated. This is normal and indicates that the expansion chamber is functioning properly.

# IMPORTANT SAFETY INSTRUCTIONS

## PLEASE READ ALL INSTRUCTIONS VERY CAREFULLY

When using electrical appliances, basic safety precautions should always be followed including the following:

1. Read all instructions.
2. To protect against electrical shock, do not place cord, plugs, or appliance in water or other liquid.
3. Do not operate any appliance with a damaged cord or plug, or after the appliance malfunctions. Return appliance to the factory for examination, repair or adjustment. See Warranty insert.
4. Do not use outdoors or in damp area.
5. Do not let cord hang over edge of table or counter, or touch hot surfaces.
6. Do not use appliance for other than intended household use.
7. When using this appliance, provide 4 to 6 inches of air space around the entire unit for air circulation.
8. Do not attempt to service this product. Repairs should be done by authorized service personnel.
9. Do not let children operate. The water can cause severe burns.

### SAVE THESE INSTRUCTIONS. THIS PRODUCT FOR HOUSEHOLD USE ONLY.

The alert symbols displayed at right point to important safety information to make you aware of potential hazards that can cause serious injury or death. Please pay special attention to the information following these alerts and warnings. Failure to comply with these instructions can result in property damage, serious injury or death.



**WARNING**

**DANGER**

## ELECTRICAL REQUIREMENTS

### Recommended Ground Method

For your personal safety, the hot water dispenser is equipped with a power supply cord having a 3-prong ground plug. To minimize possible shock hazard, the cord must be plugged into a mating 3-prong, ground-type outlet, grounded in accordance with the National Electrical Code, ANSI/NFPA 70 — latest edition\* or CSA Standard C22.1, Canadian Electrical Code, Part 1, — latest edition\*\* and all local codes and ordinances.

If a mating outlet is not available, it is the personal responsibility and obligation of the customer to have a properly grounded, 3-prong outlet installed by a qualified electrician.

Copies of the standards listed may be obtained from:

\* National Fire Protection Association  
One Batterymarch Park  
Quincy, MA 02269

\*\*CSA International  
178 Rexdale Boulevard  
Toronto, Ontario M9W1R3

If codes permit and a separate ground wire is used, it is recommended that a qualified electrician determine that the ground path is adequate.

A 120 volt, 60 Hz, AC only 15 or 20 ampere fused, grounded electrical supply is required. It is recommended that a separate circuit serving only your hot water dispenser be provided.

**WARNING**

**Electrical Shock Hazard**



**Plug into a grounded 3 prong outlet.**

**Do not remove ground prong.**

**Do not use an adapter.**

**Do not use an extension cord.**

**Failure to follow these instructions can result in death, fire or electrical shock.**

**NOTE:** Use an outlet that cannot be turned on/off by a switch.



# HOT WATER CONCEPT

Unlike a household water heater, this dispenser tank is not pressurized for safety reasons. For a conventional household water heater, the faucet valve is placed after the heater tank resulting in a pressurized tank. For a hot water dispenser, the faucet valve is placed before the tank, creating an "open vent" style faucet and consequently no pressure is built up inside the tank.

## OVERVIEW

1. Make sure you have all necessary parts, tools and materials as suggested on manual cover.
2. Determine a convenient location to mount your faucet. This can be an existing sink hole in the sink top (the spray hose opening for example) or you may drill another hole into the sink or counter-top. As you determine the location of your faucet, consider the container you will use with the appliance, such as a large cooking pan. Location of the hole should also provide easy access for tank connections.
3. The thickness of the sink or counter will depend on the type of faucet being installed.
4. Before connecting to the power source, the dispenser must be filled with water and the thermostat turned to the **OFF** position.
5. Do not use an extension cord with this appliance. Appliance must be within 36" (914mm) of the power source. See electrical requirements.
6. Plumbing connections must comply with all local codes and ordinances.
7. Do not use any pipe sealing compounds as they may get inside the dispenser causing an objectionable taste and odor.

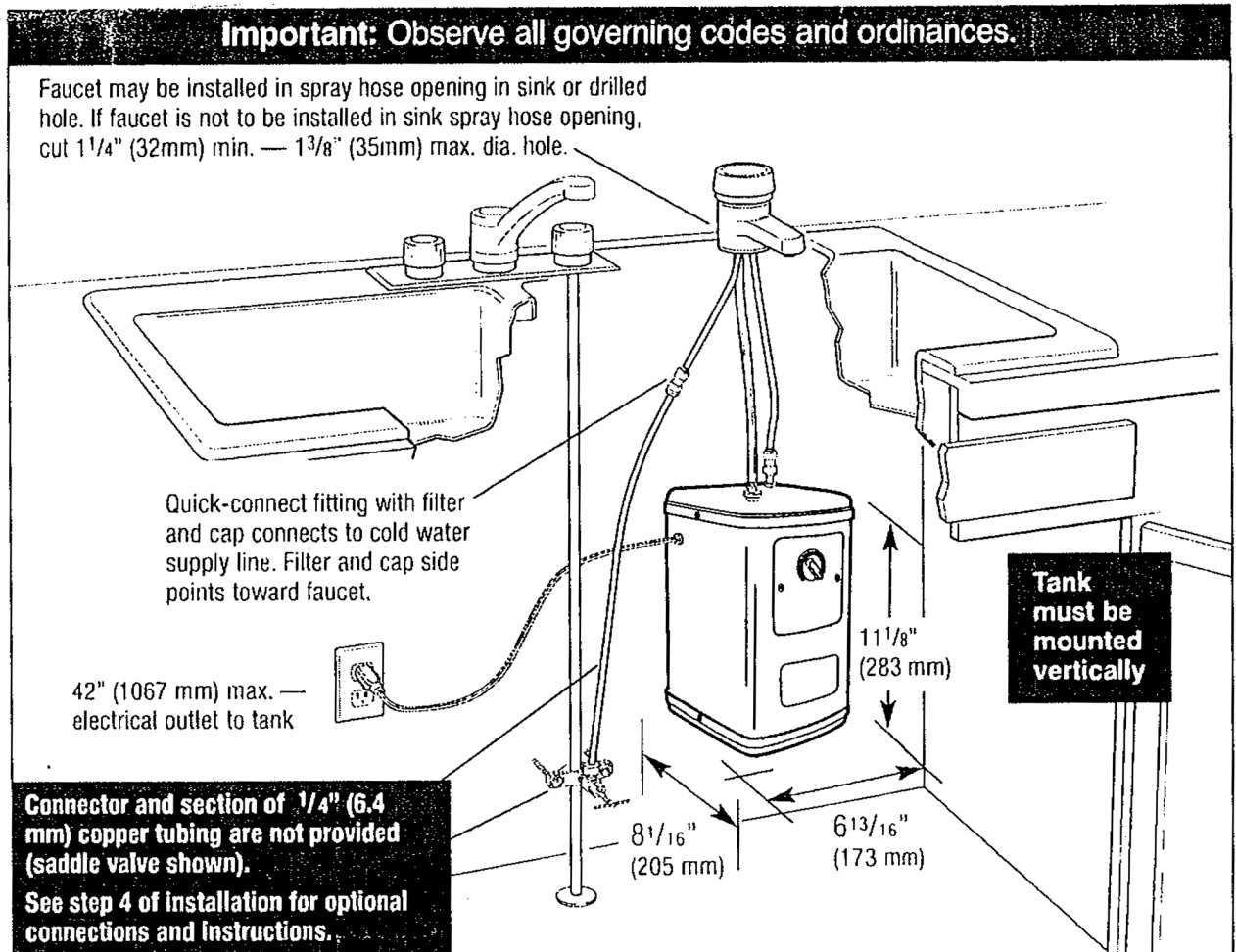

# INSTALLATION

## Before You Begin

Determine where you will install your hot water dispenser. The faucet can be mounted in an existing hole in the sink (spray hose, etc.), or drill a 1<sup>1</sup>/<sub>16</sub>" (27 mm) to 1<sup>3</sup>/<sub>8</sub>" (35 mm) hole in your sink. If you want to use the spray unit or do not have a hole in your sink you will have to drill a new hole.

**Stainless Steel:** You need a 1<sup>1</sup>/<sub>16</sub>" (27 mm) to 1<sup>3</sup>/<sub>8</sub>" (35 mm) knockout punch available at most hardware stores or drill a hole with an expandable drill.

**Porcelain:** Proper tools are required to drill through a porcelain or cast iron sink. If you are not familiar with this process you should consider having this done by a professional plumber.

Do not attempt to drill without these special tools as you may severely damage your sink.

**BE SURE TO CONFIRM YOUR FAUCET'S COMPATIBILITY WITH THIS APPLIANCE.  
FAUCET MUST BE "OPEN VENT" STYLE.**

## Step 1 - Mounting Tank

Position tank vertically beneath faucet so the flexible tube from the faucet reaches the center faucet supply tube on the tank and tank touches the wall. Mark the wall at the top of tank. Set tank aside. Mark a second line 2<sup>1</sup>/<sub>8</sub>" (54 mm) below the first line. Align bottom of bracket even with the second line and screw into place. If a stud is not available, drywall anchors may be used for additional support. Hang tank on bracket.

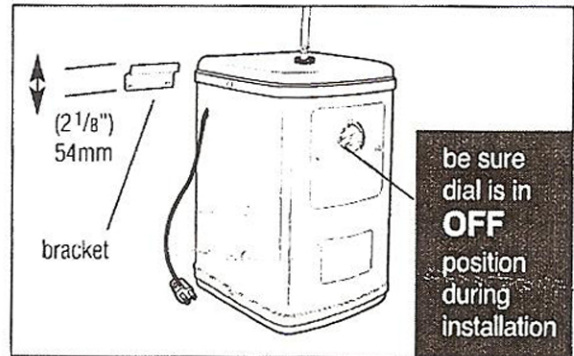

**NOTE:** The tank must be positioned so the hose to the faucet does not twist or kink.

**Step 2 - Install Faucet** Follow the instructions included with faucet.

## Step 3 - Connect Faucet to Tank

Connect 1/4" (6.4 mm) faucet copper line (longer piece) or red line to the rear tube at the top corner of the tank with the quick-connect fitting supplied with the appliance. (**Do not** use the quick-connect fitting with filter and cap.) Push line straight into quick-connect fitting as far as possible for both connections.

Use pliers to open clamp and thread hose through clamp then push fully onto center inlet tube on top of tank. The clamp should create a secure connection when properly installed.

Be sure the hose is not twisted or kinked. Hose may be shortened if necessary.

**NOTE: DO NOT** lengthen the hose – dispenser performance will be impaired and warranty will be void.

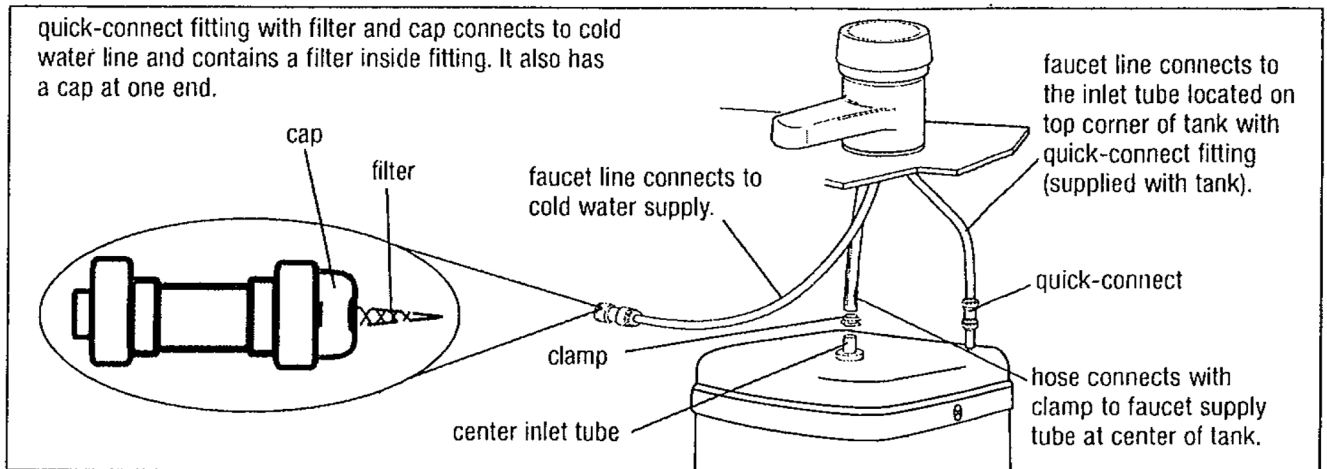

## Step 4 - Connect Cold Water Supply

### Check Filter in Quick-Connect Fitting

The cone-shaped screen filter comes seated inside the quick-connect fitting with the narrow end pointing towards the cap which is also attached to the fitting. (The open or wide end of the screen is inserted into the fitting.) However, the filter may become dislodged in the shipping process. Check to see that it is seated correctly within the fitting. If the cap is still in place, pop cap off by slipping a screwdriver into the notch and lift off. Gently pull on the screen. If it comes loose, push in with a light jiggling or wiggling motion until it snaps into place. If installed properly, a gentle pull should not dislodge it.

*Refer to installation instructions included with faucet if necessary.*

Cold water is supplied to the tank through the faucet. Connect the cold water line to the faucet using the 1/4" (6.4 mm) supply line and the quick-connect fitting that contains a cone shaped screen filter (supplied with the tank.) The cap end of the fitting connects to the faucet line.

It is suggested that a shut-off valve be installed between this connection and the cold water supply line. Another common installation method is with the use of a saddle valve illustrated below. If a saddle valve is used, follow the manufacturer's installation instructions.

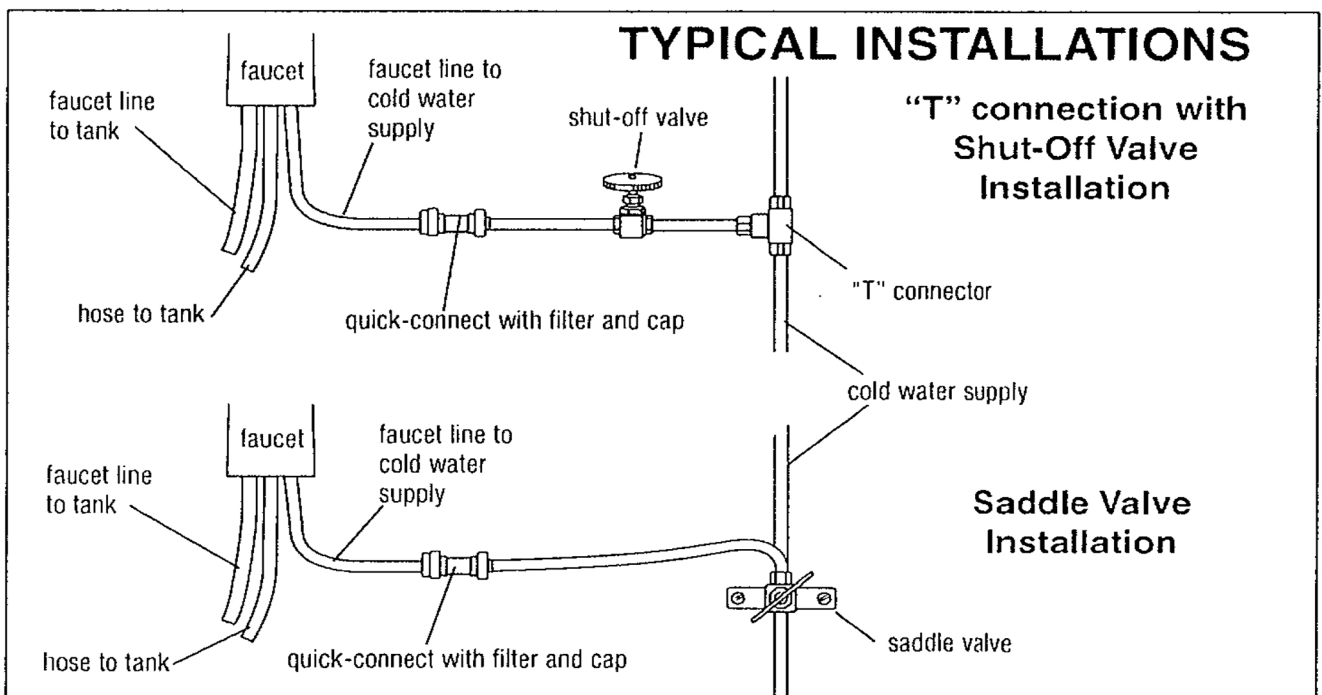

## Step 5 - Check for Leaks

Open valve in water line. Turn faucet on (hold if necessary) to fill tank (about 1 minute). When tank is full, water will flow from faucet. Turn faucet off. Check for leaks.

## Step 6 - Prepare for Power

Double check thermostat control dial is in the **OFF** position. Thermostat control dial controls the water temperature, not the water flow or delivery.

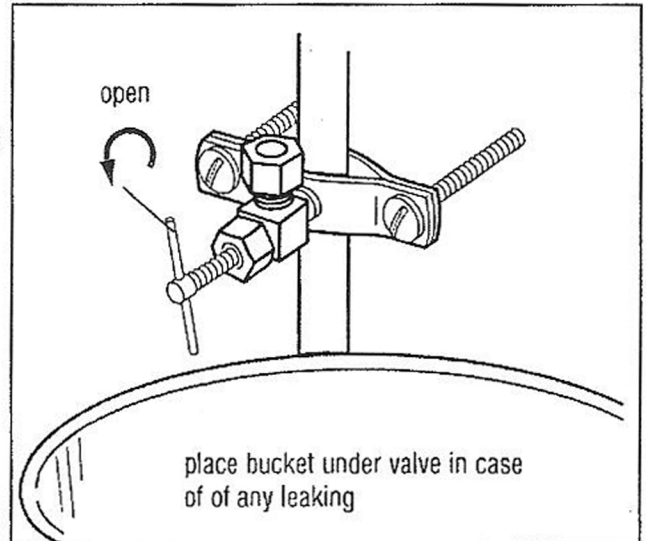

### **IMPORTANT INFORMATION - This dispenser is equipped with a Self Re-setting Thermal Fuse**

Turn thermostat to **OFF** position and fill tank with water before plugging the power cord from the tank into an electrical outlet

If tank is empty and the thermostat set in the **ON** position when the power cord is connected, the self re-setting fuse in the heater control will disconnect the current to the heater after approximately one minute, thus protecting the heater from a "dry start" failure. The fuse in the heater control will self-reset after approximately 1/2 hour\*. Turn on the water supply to the tank and continue the installation.

Continued misuse will cause damage to the appliance and is detectible thus, voiding the warranty.

\*(Re-setting of fuse can be accelerated by turning on the water supply and dispensing water until use re-sets, approximately 3 minutes.)

## Step 7 - Test Installation

Plug electrical cord into a grounded 3-prong outlet.

Do not use an outlet controlled by an off/on wall switch. Turn thermostat control dial clockwise to the highest position. Maximum temperature will be reached in about 15 minutes and dispenser will be ready for use. Lower the temperature setting by turning thermostat control dial counterclockwise if you notice vapor or a boiling noise. To raise or lower the water temperature, rotate the thermostat dial. At the **LOW** setting of thermostat dial water temperature will be approximately 140°F (60°C) and at the **HIGH** setting of the thermostat dial water temperature will be approximately 200°F (93°C).



# TROUBLESHOOTING

---

**The following situations are not covered by the One Year Replacement Warranty.**

1. Water is not hot: (assuming cold water supply is connected properly and valve is open)

- Check if dispenser is plugged in.
- Turn thermostat control dial fully clockwise. This may produce boiling water in approximately 15 minutes and possibly be accompanied by a gurgling sound in the tank and/or water "sputtering" from the faucet.

If the water boils, turn thermostat control dial slightly counterclockwise until the gurgling and/or "sputtering" stops. This should take place within 20 seconds. Turn control dial an additional 1/8" (3mm) counterclockwise at the tip of the dial. Wait 15 minutes and check the temperature of the water.

- Check for blown fuse or circuit breaker is tripped (also see IMPORTANT NOTE explaining the self re-setting thermal fuse in step 6 of installation).

**NOTE:** The thermostat activates the heater after water temperature in the tank drops approximately 15°F (8°C) from the maximum setting. The dispenser does not produce a continuous flow of hot water.

2. Hot water drips or sputters from faucet:

- Turn thermostat control dial counterclockwise (see item 1).
- Check that the hose connecting the faucet to the dispenser tank is not clogged, twisted or kinked.
- If quick-connect fitting is connecting cold water supply, check for a clogged filter screen in quick-connect fitting (see CLEANING AND MAINTENANCE of faucet manual).
- Check for proper installation of copper tubing from faucet to dispenser tank and faucet to water line. If connected backwards or cross-connected, valve may be damaged. Refer to Step 4 in this manual.

3. Water does not flow right away or at all:

- Due to high temperature and for safety reasons, the tank is not under pressure causing a slight delay in water flow.
- Make sure all valves on water supply are open.
- Check hose from faucet for twisting or tight bending.
- Check if quick-connect filter screen or faucet filter screen is clogged (see faucet manual).

4. Water boils or vapor appears:

- Lower temperature setting by turning thermostat control dial counterclockwise.

**NOTE:** If lowering the thermostat setting does not stop the boiling, unplug the power supply cord and contact customer service.

# CLEANING AND MAINTENANCE

## Seasonal Shutdown

To prevent damage when dispenser is exposed to freezing temperatures, water must be drained.

1. Unplug dispenser tank to power supply.
2. Turn thermostat control dial to **OFF** position (fully counterclockwise).
3. Turn faucet on and run water until water is cold.
4. Place a 3-quart (2.8 L) container under drain plug at bottom of the tank. Use a screwdriver to remove the screw and O-ring in the drain tube opening. When tank is fully drained replace O-ring and screw. Tighten to reseal the drain.

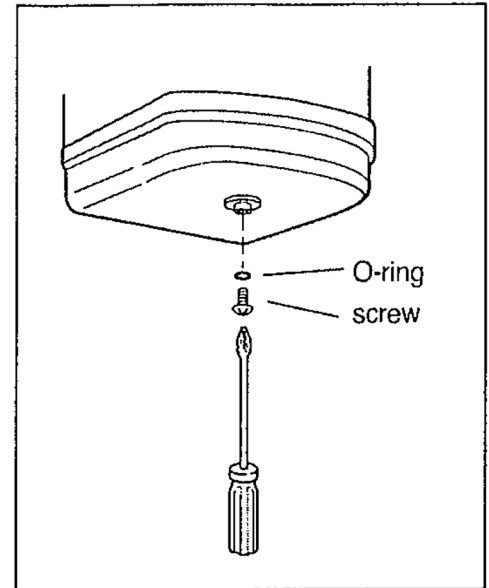

**NOTE:** Do not plug appliance into power supply if tank is empty.

## Cleaning Quick-Connect Filter Screen at Cold Water Inlet

If you notice that the water flow is reduced, it may be necessary to clean the quick-connect screen. Refer to installation Step 4.

1. Turn thermostat dial to the "Off" position. Turn on faucet and run water until it is cold to avoid possibility of burn.
2. Release cap with a screwdriver, pry it loose using the notch in the cap.
3. Also using the screwdriver push in on the smallest ring around copper line. This action releases tension, allowing disconnection of the copper line and quick-connect.
4. Pull cone shaped filter screen out (there will be slight tension) and clean with vinegar as necessary. Check cap and clean as necessary. If deposits have hardened, soak in vinegar for an hour or two. Then use a brush to clean.
5. Reassemble in reverse order of disassembly. Be aware, when inserting the screen back into place there is a slight resistance. Push until the screen "pops" into place. Check for leaks.
6. Turn thermostat dial to the "Max" setting. The dispenser will be ready in about 15 minutes.

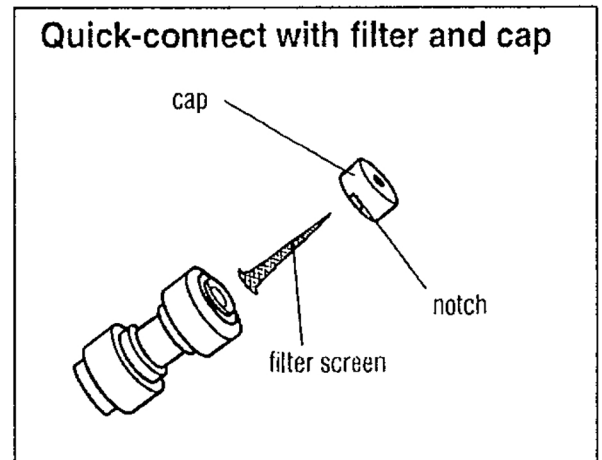

**WESTBRASS**  
Fine Decorative Plumbing Since 1935

2429 E Olympic Blvd., Los Angeles, CA 90021 • (213) 627-8441  
Fax (213) 627-2844 • info@westbrass.com • www.westbrass.com