



COSMOPOLITAN/ESSEX/CITY

STORAGE OTTOMAN BENCH BANC ET OTTOMAN DE RANGEMENT

REQUIRES 2 PEOPLE
FOR EASE OF ASSEMBLY

ITEM NUMBER / NUMÉRO D'ARTICLE
INT-AXCCOS-OTTBNCH-01

REQUIERT 2 PERSONNES
POUR FACILITER
L'ASSEMBLAGE

USER ASSEMBLY GUIDE
GUIDE D'ASSEMBLAGE

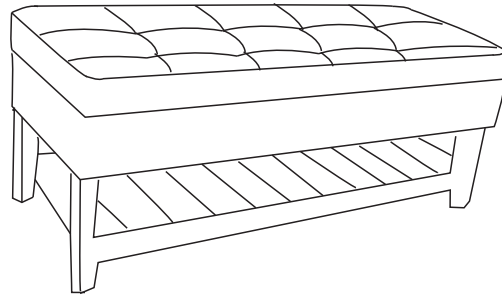

Like us on **facebook**
& share your pictures and
comments to be eligible
for exclusive promotions.

Suivez-nous sur **facebook**
partagez vos photos et vos
commentaires afin d'être admissibles
à des promotions exclusives.

www.facebook.com/simplihomefurnishings



DO NOT RETURN

FOR REPLACEMENT PARTS OR
OTHER INQUIRIES
PLEASE CONTACT US AT:
CUSTOMERSERVICE@ACCESS-WORLD.COM
PLEASE BE SURE TO HAVE THE MODEL
NUMBER FROM THE PACKAGING OR
INSTRUCTION BOOKLET.

POUR OBTENIR DES PIÈCES DE REMPLACEMENT
OU POUR AUTRE DEMANDE, VEUILLEZ
COMMUNIQUER AVEC NOUS:
CUSTOMERSERVICE@ACCESS-WORLD.COM
VEUILLEZ-VOUS ASSURER D'AVOIR EN
MAINS LE NUMÉRO DE MODÈLE OU LE
LIVRET D'ASSEMBLAGE.

WyndenHall
HOME DECOR

SIMPLI
HOME

brooklyn + max

For more information visit us on our website www.simpli-home.com

COSMOPOLITAN/ESSEX/CITY
 STORAGE OTTOMAN BENCH
 BANC ET OTTOMAN DE RANGEMENT

PARTS DESCRIPTION / DESCRIPTIONS DES PIÈCES

1

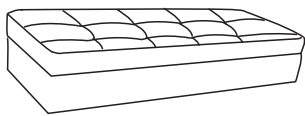

OTTOMAN

1 PIECE
 1 PIÈCE

2

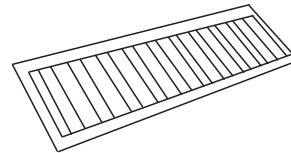

SHELF
 TABLETTE

1 PIECE
 1 PIÈCE

3



LEG
 PATTE

4 PIECE
 4 PIÈCES

REQUIRES 2 PEOPLE FOR EASE OF ASSEMBLY
 REQUIERT 2 PERSONNES POUR FACILITER L'ASSEMBLAGE

HARDWARE / QUINCAILLERIE

A



Allen Key Screw
 Vis Allen

M6x30mm
 4 PIECE
 4 PIÈCES

B

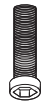

Allen Key Screw
 Vis Allen

M6x55mm
 4 PIECE
 4 PIÈCES

C

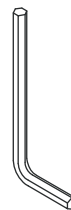

Allen Key
 Clef Allen

1 PIECE
 1 PIÈCE

COSMOPOLITAN/ESSEX/CITY STORAGE OTTOMAN BENCH

ASSEMBLY INSTRUCTIONS / INSTRUCTIONS D'ASSEMBLAGE

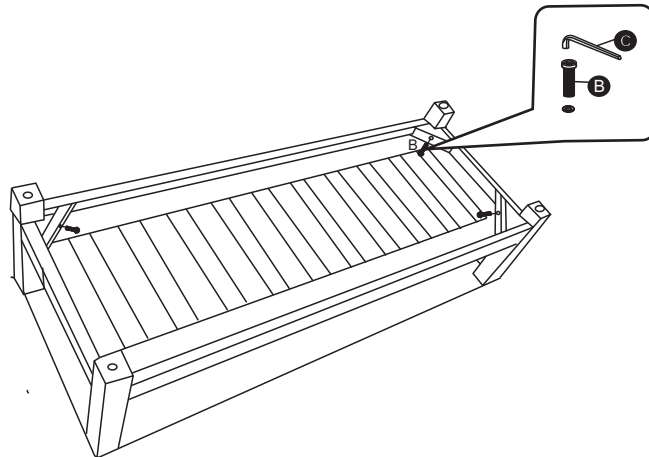

STEP1

Place the ottoman ① on its back on a flat smooth surface

Attach the legs ③ to the shelf ② using screws ⑥ Use Allen Key ⑦ to tighten

Étape1

Placez l'ottoman ① à l'envers sur une surface douce et plane

Fixez les pattes ③ à la tablette ② avec les vis ⑥. Utiliser une clef Allen ⑦ pour serrer

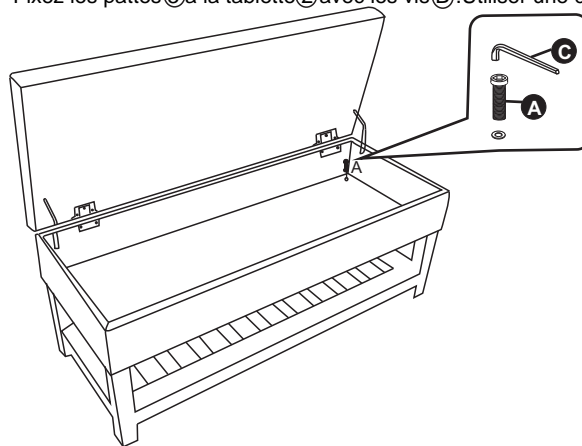

STEP2

Attach the legs ③ with the shelf ② to the ottoman ① using screws ⑧ Use Allen Key ⑦ to tighten

Étape2

Fixez les pattes ③ et la tablette ② à l'ottoman ① avec les vis ⑧. Utiliser une clef Allen ⑦ pour serrer

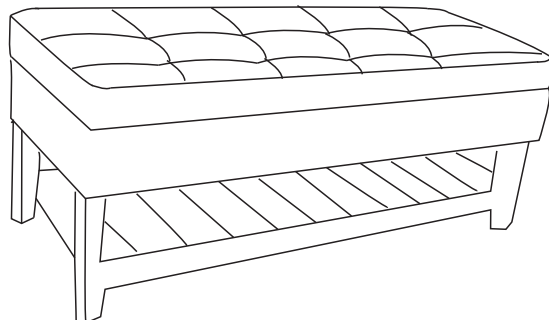

Turn storage ottoman right side up

Remettre l'ottoman à l'endroit.