

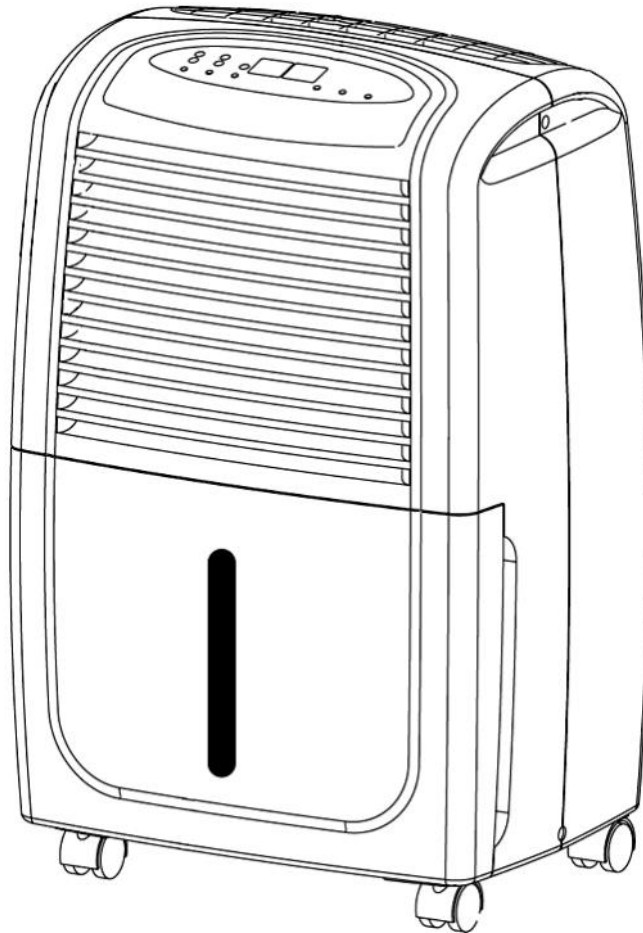

# WHYNTER 70 PINT RESIDENTIAL PORTABLE DEHUMIDIFIER WITH BUILT-IN PUMP

Model # : RPD-702WP

## INSTRUCTION MANUAL



Congratulations on your new Whynter product. To ensure proper operation, please read this Instruction Manual carefully before using this product. Keep this manual in a safe place for future reference.

Thank you for choosing the Whynter Portable Dehumidifier. Please follow the instructions provided in this user guide to obtain the very best performance from your dehumidifier. We trust that your Whynter dehumidifier will provide the performance and reliability that we stand for.

Your Whynter dehumidifier is designed to remove moisture in the air by condensation removal and collecting the condensation water in the internal water bucket or draining through a drain hose.

Please keep this user manual in a safe place for future reference.

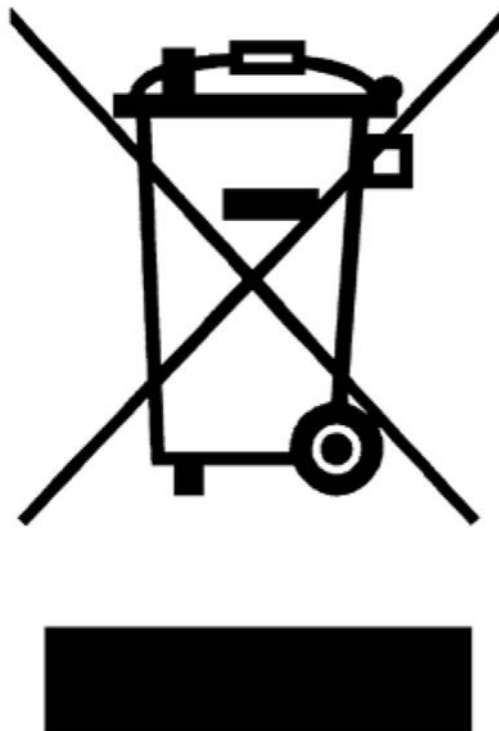

This symbol on the product or its packaging indicates that the appliance cannot be treated as normal domestic trash, but must be handed in at a collection point for recycling electric and electronic appliances. Your contribution to the correct disposal of this product protects the environment.

Further information about the recycling of this product can be obtained from your local municipal authority.

## TABLE OF CONTENTS

	<u>PAGE</u>
DISPOSAL INFORMATION	<u>2</u>
I. SAFETY PRECAUTIONS	<u>4</u>
II. INTRODUCTION	<u>5</u>
III. PARTS AND CONTROLS	<u>6</u>
IV. OPERATION INSTRUCTIONS	<u>7 - 8</u>
V. CONTINUOUS DRAINAGE	<u>9</u>
VI. MAINTENANCE	<u>10</u>
VII. TIPS ON WHEN TO USE YOUR PORTABLE DEHUMIDIFIER	<u>11</u>
VIII. TROUBLESHOOTING	<u>12 - 13</u>
WARRANTY INFORMATION	<u>14</u>

## I. SAFETY PRECAUTIONS

### WARNING

TO REDUCE THE RISK OF FIRE, ELECTRICAL SHOCK, OR INJURY WHEN USING YOUR PORTABLE DEHUMIDIFIER, FOLLOW THESE BASIC PRECAUTIONS:

- Read all instructions before using the appliance
- Never clean appliance parts with flammable fluids. The fumes can create a fire hazard. Do not use an excessively wet cloth, industrial solvents, and oil-based products to clean this appliance
- Do not store or use gasoline or any other flammable vapors and liquids in the vicinity of this or any other appliance. The fumes can create a fire hazard
- Do not abuse, sit on, or stand on the appliance
- This appliance is not intended for use by persons (including children with reduced physical, sensory or mental capabilities, or lack of experience and knowledge, unless they have been given supervision or instruction concerning use of the appliance by a person responsible for their safety
- Children should be supervised to ensure that they do not play with the appliance
- If the power cord is damaged, it must be replaced by the manufacturer or its service agent or a similarly qualified person in order to avoid a hazard
- Please dispose of packing materials properly
- Use the portable dehumidifier only for its intended function. This appliance is designed for household, non-commercial use only. Any other use will void the warranty
- To avoid the risk of shock, the product should never be used in bathrooms, shower rooms, or in any other steamy or wet areas
- During installation, the power supply must not be excessively or dangerously bent or flattened
- Do not tamper with controls
- Make sure the plug is placed fully and firm into the wall socket. If the wall receptacle you intend to use is not adequately grounded or protected by a time delay fuse or circuit breaker, have a qualified electrician install an outlet that is appropriate to local electrical codes and requirements
- Do not use multiple socket. Do not use multiple socket or of an extension cord as it may overheat and become a risk of fire.
- Make sure the plug is clean before usage
- Do not turn this appliance on and off by plugging and unplugging. Always use the ON/OFF switch
- After turning the appliance off, please take the plug out of the socket
- Make sure hands are dry when connecting the power plug. The appliance is equipped with a three-prong grounded plug on the power cord for your protection. Never modify, remove or attempt to repair the plug yourself
- Do not repair, disassemble and/or modify the appliance by yourself
- Always turn off the appliance when cleaning the air filter, and transporting
- At the end of each season, all water must be drained from the appliance and air filter must be cleaned before storage
- Do not drink or use the water collected or drained from the appliance
- Do not remove the water bucket during operation
- Transport the appliance in an upright position only, or leave it in an upright position for at least 2 hours before first use
- When positioning or moving the appliance, ensure that it is not turned upside down or greater than 45° or more off level.
- This appliance must be installed in an area protected from the element, such as wind, rain, water spray or drips
- Always place the appliance on even and hard and level surface that can support the unit when it is full
- Ensure objects are not obstructing the exhaust and air intake
- Never insert your fingers or other objects into the air intakes and air outlets
- Do not operate the appliance without the air filter

**THE MANUFACTURER DISCLAIMS ANY RESPONSIBILITY IF THE ABOVE INSTRUCTIONS ARE NOT FOLLOWED**

## II. INTRODUCTION

### How it Works

When the dehumidifier is started, the fan begins to pull moisture-laden air across the dehumidifying coils. The coils condense or draw moisture from the air, and air flows through the top louver into the room as dry, warm air. Moisture removed from air is collected in a water bucket on the front of the dehumidifier.

The appliance is designed to operate between 41°F (5°C), and 96°F (35°C). The "Compressor" circuit has an automatic 3 minute time delayed start if the appliance is turned off and on quickly. This prevents overheating of the compressor and possible circuit breaker tripping. Make sure the water bucket is fitted correctly otherwise appliance will not turn on.

### Energy Saving Guide

This Whynter dehumidifier is an Energy Star rated appliance. Follow the guide below can help to get the best performance and efficiency from your dehumidifier.

- Do not cover the air intake and outlet.
- Do not place the appliance in front of curtains or drapes- to ensure they do not obstruct the air intake.
- Keep curtains, blinds or drapes closed during the sunniest part of the day.
- Close all windows and doors.
- Indoor relative humidity should ideally be kept between 35%RH and 60%RH depending on the ambient temperature.
- Make sure the appliance is on a hard and level surface.
- To prolong the compressor's life, please wait at least 3 minutes before turning the appliance back on after shutting it off.
- Inspect and keep the air filter clean by cleaning regularly.
- Perform routine maintenance.

### TECHNICAL DATA

MODEL :	RPD-702WP
Dehumidifying capacity	70 pints/ day
EEV (Liters per kW-Hour)	CAN/CSA-C749-07
Power supply	115v/ 60Hz
Maximum power input	950W
Current Consumption	7.5 Amps
Refrigerant	R-410A / 12.2 OZ
Air flow M3/H / CFM	187 M3/H / 76.5 CFM
Fan speeds	2 (H & L)
Unit Dimensions	23.25" H x 14.5" W x 11.25" D (22" in H when casters are not installed)
Unit Net Weight	45 lbs
Unit Gross Weight	50 lbs
Noise Level (dBA)	55.3

### III. PARTS AND CONTROLS

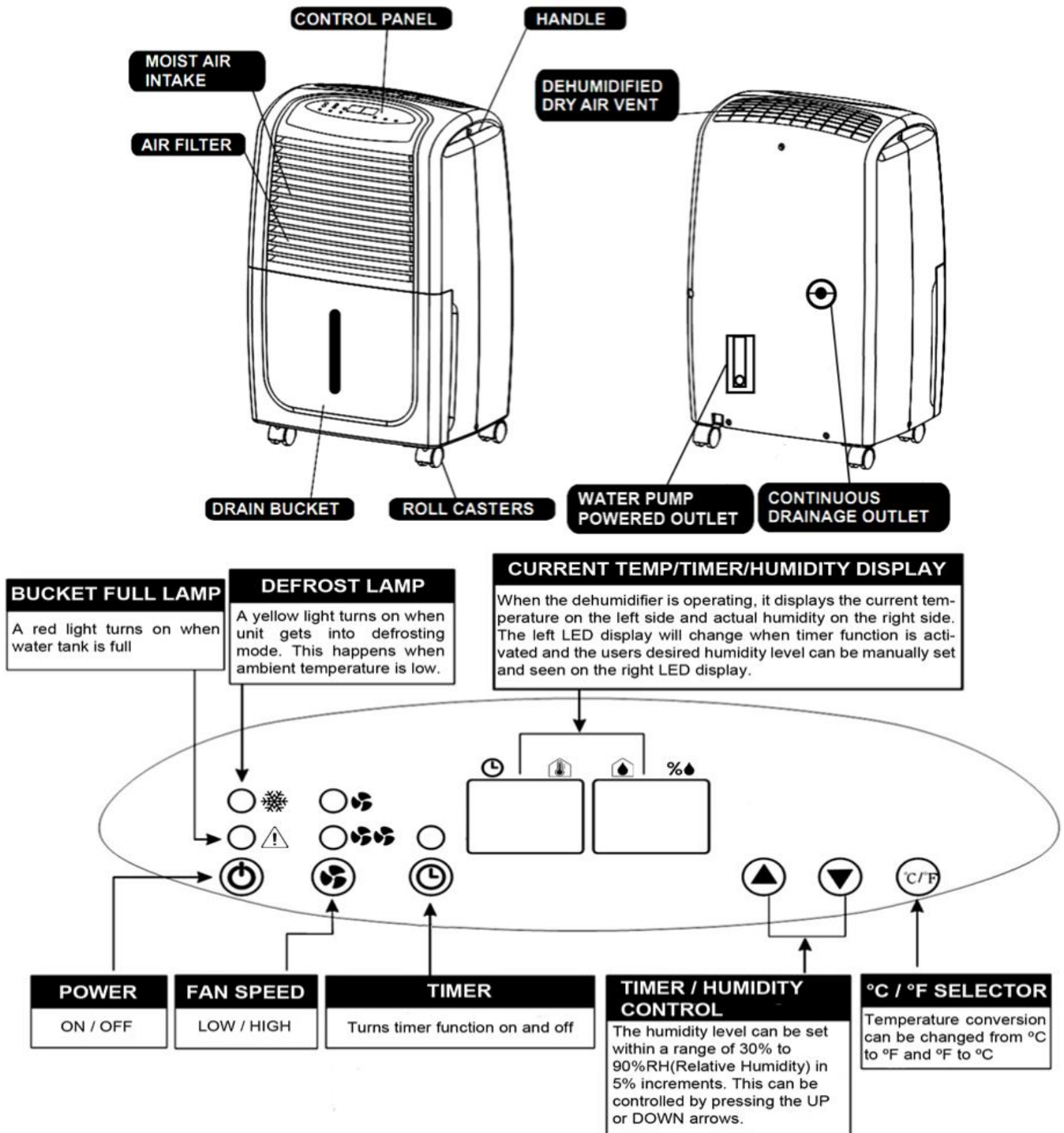

**Auto Shut Off**

When the selected humidity level is reached, the dehumidifying function will shut off automatically

**Energy Saver**

Once the RH% is reached, the fan will still run continuously to avoid high start-up amperage which makes the unit energy-efficient

**Auto-Restart**

In the event of a power outage, appliance restarts at the previously set function mode and settings when power is restored (not applicable to Timer Function)

**Timer Delay Switch Off**

When the appliance is ON, press the Timer button to activate Auto-stop function and the Timer light will come on.

Set the desired time delay OFF hours by pressing the UP and DOWN and buttons. The time increments are 1 hour up to 24 hours. When the delay time set has elapsed, the appliance switches off. To cancel the delayed switch off function, set the time to "00" or turn off the appliance.

**Timer Delay Switch On**

When the appliance is OFF, press the Timer to activate Auto-start function and Timer light will come on. Set the desired time delay ON hours by pressing the UP and DOWN and buttons. The time increments are 1 hour up to 24 hours. When the delay time set has elapsed, the appliance turns on. To cancel the delayed switch on function, set the time to "00" or turn off the appliance.

## IV. OPERATION INSTRUCTIONS

### AIR FILTERS INSTALLATION

Your Whynter portable dehumidifier is equipped with a removable and washable filter. The filter removes large particles such as dust, pet hair and dander.

**WARNING: NEVER OPERATE THE DEHUMIDIFIER WITHOUT THE FILTER**

### START OPERATION

1. Ensure that the appliance is connected to the power socket
2. Make sure the water bucket is placed in proper position.
3. Make sure filter is installed
4. When the unit is turned on for the first time, if the bucket full lamp lights up, just pull out the water bucket then push it back to the proper position.
5. Set the relative humidity level RH% by pressing the up and down buttons. We recommend setting the RH% to at least 10% lower than the current RH%.

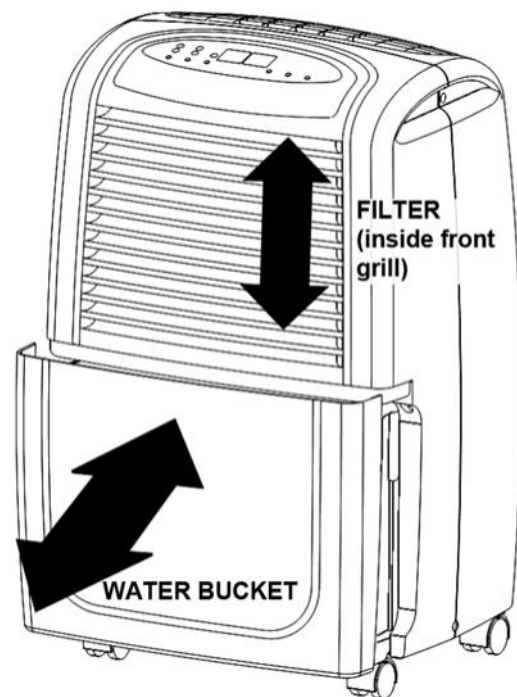

### WHEN BUCKET FULL LAMP IS ON

The appliance will run continuously until the set RH% is reached or when the water bucket is full. When the water bucket is full, the Bucket Full indication lamp will light up and the dehumidifier will stop operating. Remove the water in the bucket with two hands, then place the water bucket back to its proper position the machine will start operating again. This light will also illuminate when the bucket is removed or not properly inserted.

### DEFROST

In the event frost builds up on the evaporator coils, the compressor will cycle off and the fan will continue to run until the frost is evaporated. This happens when the appliance is operating in low temperatures (less than 53°F or 12°C), which affects the efficiency of the dehumidifier. When this happens, the defrost lamp will turn on and the machine will go into periodic defrost mode automatically. Defrost time may vary. If the dehumidifier freezes up, turn the appliance off for few hours and then restart. The appliance will not operate satisfactorily if the room temperature is below 41°F

## IV. OPERATION INSTRUCTIONS

### CASTER INSTALLATION

Caster installation is recommended to avoid damage to floors .

1. Remove the casters from the bucket of the dehumidifier .
2. Position the dehumidifier on its side .
3. Locate the arrow on the bottom of the dehumidifier and insert the caster according to the arrow direction.
4. Slide the caster in as far as it will go. The caster will snap into place
5. Repeat steps 1 to 4 for the other 3 casters.

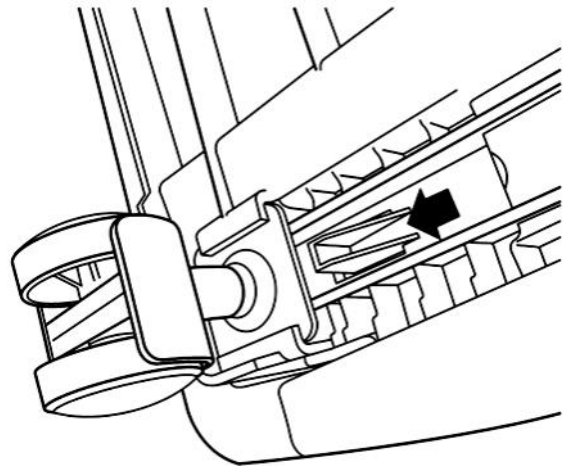

### POSITIONING THE UNIT

- This dehumidifier is intended for indoor residential applications only and should not be used for commercial or industrial applications.
- Place the dehumidifier on a smooth, hard and level floor strong enough to support the appliance with a full bucket of water.
- Do not attempt to roll the appliance over objects.
- Avoid placing the appliance in an area where the temperature will fall below 53°F. The coils may become covered with frost and may reduce performance.
- Do not place the appliance near clothes dryer, heater or radiator.
- Shut all doors, windows and openings to your target dehumidifying space for maximum performance
- Allow at least 10" of air space on all sides of the appliance for good air circulation and 20" or more above the appliance

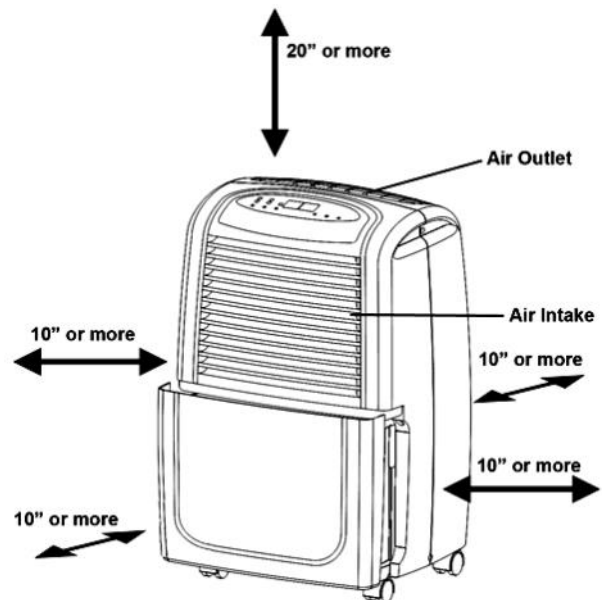

### NOTE:

- Dehumidifiers working in a basement will have little or no effect on adjacent enclosed rooms such as closets, unless there is enough circulation of air in and out of the enclosed area.
- If the appliance has been switched off and needs to be switched on again, allow approximately three minutes for the correct operation to resume.
- Select a suitable location and make sure you have easy access to the electrical outlet.
- Ensure the air filter and water bucket are correctly installed before switching the appliance on.
- Always be careful when moving the appliance with a full water bucket.
- Ensure that the safety requirements and warnings detailed in this user manual are followed when operating this appliance.



## V. CONTINUOUS DRAINAGE

### WATER PUMP METHOD

One of the key features of this unit is that it has a water pump that pushes water up or over a longer distance. Using this feature will enable your unit to run maintenance free, and you will no longer have to empty a heavy reservoir filled with water or worry about draining your unit using gravity.

#### INSTALLATION OF HOSE

This unit comes with a 16.5 ft. water pump hose. Once installed, the continuous drain outlet is bypassed and the water pump motor is activated.

1. Firmly insert the water pump hose to the outlet.
2. A click sound will be heard to confirm that the hose is properly attached
3. Place the other end of the hose in a floor drain where water can be expelled.

**NOTE:** Water pump motor will not activate and work if water bucket is full. Make sure water bucket is empty or not full when using this drain method.

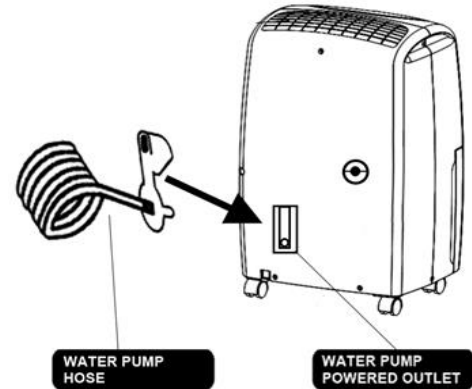

### GRAVITY METHOD

This dehumidifier also comes standard with a 3 ft. drain hose. To use gravity to drain your portable dehumidifier, it must be installed on a level surface or at least 12 inches above the ground, on a sturdy table or shelf unit. When using the function of continuous drainage, the hose must be placed horizontally below the drainage hole. Avoid uneven ground and folding the hose.

<p>1. You can use the supplied drain hose to connect to the continuous drainage connector.</p>	<p>Drain hose Back of the unit Drain cover</p>
<p>2. Unscrew and remove the drain cover at the rear of the appliance. 3. Remove the soft rubber stopper. Put it into the water bucket for safe keeping.</p>	<p>Soft rubber stopper Drain cover</p>
<p>4. Insert the drain hose through the hole of the drain cover.</p>	<p>Drain cover Drain hose</p>
<p>5. Connect the drain hose to the drain port.</p>	
<p>6. Tighten the drain cover in clockwise direction on to the rear of the appliance.</p>	<p>Drain cover Drain hose</p>
<p>7. Place the bucket on its original location.</p>	<p>Drain hose Bucket</p>

**NOTE:** When using continuous drainage setup, there may be some water collected in the water in the drain bucket

## VI. MAINTENANCE

**ALWAYS turn off and unplug the dehumidifier before cleaning.**

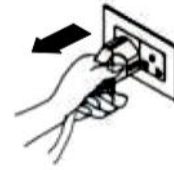

### 1. Cleaning the air grille and main unit

- Use a damp cloth to wrap the main unit or use water and a mild detergent. Do not use bleach, chemicals or abrasives.
- Do not splash water directly onto the unit. Doing so may cause an electrical shock, cause the insulation to deteriorate, or cause the unit to rust.
- Use a vacuum attachment or brush to clean the air intake and outlet grilles

### 2. Cleaning the bucket

- Clean the bucket to prevent growth of mold, mildew and bacteria every two weeks.
- Fill the bucket with clean warm water and add mild detergent to the water.
- Dry thoroughly before reinserting the bucket to the main unit.

**NOTE:** Do not clean the bucket in a dishwasher.

### 3. Cleaning the air filter

To ensure the air intake is filtered properly and to assure that your dehumidifier runs efficiently, it is recommended to clean the air filter at least once every two weeks.

- Remove the bucket and pull filter downwards
- Use a vacuum cleaner or tap the filter lightly to remove loose dust and dirt.
- Rinse the air filter under warm or cold running water (no hotter than 100F.)
- Dry thoroughly before reinserting the air filter.
- Reinstall the air filter and replace bucket securely

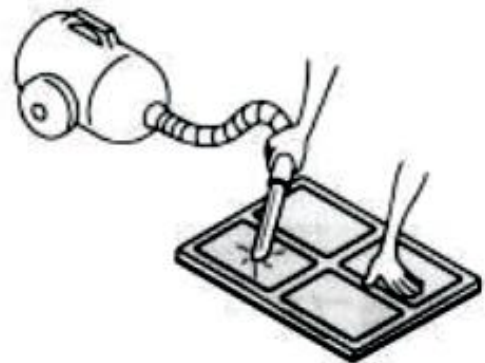
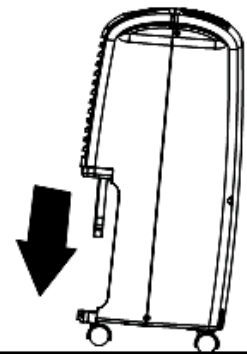

### 4. End of Season Storage

- After turning off the unit, wait 24 hours before emptying the bucket to allow excess moisture to drain into the bucket.
- Clean the main unit, water bucket and air filter as detailed above.
- Cover the unit with the original plastic bag that came with the unit or any appropriate dust cover.
- Store the unit upright in a dry, well-ventilated place.

## VII. TIPS ON WHEN TO USE YOUR PORTABLE DEHUMIDIFIER

If you have respiratory problems, asthma and allergies, your Whynter RPD-702WP portable dehumidifier is a great option for controlling moist environments. Creating dry air can keep indoor air pollutants at a more manageable level, especially when used in conjunction with an air purifier. Using your portable dehumidifier can help you save money in the long run because it uses relatively little power and can help furnaces and air conditioners operate more efficiently.

### 1. **Excess moisture**

Indoor environments with excessive moisture can cause mold and fungus to thrive inside the walls and beneath the carpet. Many types of mold are potentially dangerous and can lead to health problems. The Whynter RPD-702WP portable dehumidifier reduces the amount of moisture in the air inside a home, which makes it far more difficult for harmful mold to grow. This portable dehumidifier is also effective for a small area, such as a hallway or a child's bedroom.

### 2. **Respiratory problems or allergies**

The Whynter RPD-702WP is a 70-pint portable dehumidifier which is perfect for larger rooms or areas in your home, including a living room or family room. If your home is musty, you will want to use your portable dehumidifier, especially if you have respiratory trouble or allergies. This unit can also help relieve symptoms by controlling the relative humidity inside your home and a good idea in general if your home has such underlying problems as a leaky foundation walls or inadequate ventilation or if you live in a humid area. By keeping the relative humidity indoors below 50 percent, you can keep allergy-inducing dust mites and mold from thriving.

### 3. **Basements**

If you have a basement that is below-grade, you should use your Whynter RPD-702WP portable dehumidifier. This dehumidifier will help you keep the moisture levels in your basement down to manageable levels. By doing this, you can help keep your indoor furnace operating efficiently and even help eliminate minor standing-water problems. Your portable dehumidifier also can help keep furniture and valuables dry, and it will help keep electronics in proper working order.

### 4. **Humid climates**

In humid climates, such as areas near a beach or large body of water, your Whynter RPD-702WP portable dehumidifier can help keep the environment in your home at a more comfortable level. While the actual temperature won't be affected, you'll sleep more comfortably and may actually save money, since your unit can keep the indoor humidity and, thus, your thermostat under control.

## VIII. TROUBLESHOOTING

Problem	Possible Causes	Solutions
The dehumidifier does not operate	<ul style="list-style-type: none"> <li>• Power failure / outage.</li> <li>• The automatic switch, line fuse, or breaker has been tripped.</li> <li>• The power supply voltage is too low.</li> <li>• The power cord is damaged.</li> <li>• The dryness level you selected has been reached.</li> <li>• Water bucket is full or not positioned properly.</li> </ul>	<ul style="list-style-type: none"> <li>• Restore the power supply.</li> <li>• Flip the switch / change the fuse / turn the breaker back on. Also note that you may have too many appliances drawing power on one circuit, you may need to move the other appliances to another circuit.</li> <li>• Move the appliance onto another circuit with the correct voltage.</li> <li>• Call for service. Only authorized personnel should replace damaged power cord or power plug.</li> <li>• If you want to remove more moisture, set the timer to "00" to run the appliance continuously.</li> <li>• Empty water bucket and insert the bucket to the appliance properly.</li> </ul>
The dehumidifier runs too much	<ul style="list-style-type: none"> <li>• Windows or doors near dehumidifier are open.</li> <li>• Area to be dehumidified is too large.</li> <li>• Air movement through dehumidifier is blocked. Air grill may be dirty.</li> <li>• Continuous mode is on.</li> </ul>	<ul style="list-style-type: none"> <li>• Close all windows or doors.</li> <li>• You may need an additional dehumidifier for area.</li> <li>• Clean the air filter.</li> <li>• The appliance must be placed in a space that does not restrict air flowing into the rear coil or out of the front grill.</li> <li>• Set the RH% level and the appliance will stop when the set RH% is reached.</li> </ul>
The dehumidifier runs but the room is not dry enough.	<ul style="list-style-type: none"> <li>• Humidity setting (RH%) is too high.</li> <li>• The dehumidifier does not have sufficient clearance to operate.</li> <li>• Room temperature is too low.</li> <li>• Windows or doors are opened.</li> </ul>	<ul style="list-style-type: none"> <li>• Set the humidity level to a lower RH%. We recommend setting the RH% to at least 10% lower than the current RH%</li> <li>• Ensure there is at least 10" of clearance for proper ventilation.</li> <li>• The appliance will not operate satisfactorily if the room temperature is below 53°F (12°C)</li> <li>• Close windows or doors.</li> </ul>
Frost appears on the coils above the bucket.	<ul style="list-style-type: none"> <li>• The dehumidifier has been turned on recently.</li> <li>• Room temperature is too low.</li> </ul>	<ul style="list-style-type: none"> <li>• This is normal due to refrigerant rushing through the coil. Frost will usually disappear within 60 minutes.</li> <li>• The appliance will not operate satisfactorily if the room temperature is below 53°F (11°C)</li> </ul>
The dehumidifier makes loud noise.	<ul style="list-style-type: none"> <li>• Appliance not level.</li> </ul>	<ul style="list-style-type: none"> <li>• Shut off the appliance and let it sit on level surface for at least 6 hours</li> </ul>
The dehumidifier leaks.	<ul style="list-style-type: none"> <li>• Continuous drainage hose is loose.</li> <li>• Cracked water bucket.</li> </ul>	<ul style="list-style-type: none"> <li>• Secure the drain hose.</li> <li>• Contact customer service.</li> </ul>

## VIII. TROUBLESHOOTING - ERROR CODES

Error Code	Reason
"30%RH"	Humidity Sensor has an open circuit or humidity is less than 30%
"90%RH"	Humidity Sensor has short circuit or humidity is higher than 90%
"Lo"	Temperature is lower than 32°F or temperature sensor has an open circuit
"Hi"	Temperature is higher than 122°F or temperature sensor has a short circuit

# ONE YEAR LIMITED WARRANTY

This WHYNTER portable dehumidifier is warranted, to the original owner within the 48 continental states, for one year from the date of purchase against defects in material and workmanship under normal use and service. Should your WHYNTER portable dehumidifier prove defective within one year from the date of purchase, return the defective part or appliance, freight prepaid (within two months of purchase; after two months to one year, customer will be responsible for freight cost to Whynter's service department), along with an explanation of the claim to Whynter LLC. Please package the portable dehumidifier carefully in its original packaging material to avoid damage in transit. Please retain the original box and packaging material. Under this warranty, Whynter will repair or replace any parts found defective. This warranty is not transferable. After the expiration of the warranty, the cost of labor and parts will be the responsibility of the original owner of the appliance.

## THIS WARRANTY DOES NOT COVER:

- Acts of God, such as fire, flood, hurricanes, earthquakes and tornadoes.
- Damage, accidental or otherwise, to the portable dehumidifier while in the possession of a consumer not caused by a defect in material or workmanship;
- Damage caused by consumer misuse, tampering, or failure to follow the care and special handling provisions in the instructions.
- Damage to the finish of the case, or other appearance parts caused by wear.
- Damage caused by repairs or alterations to the product by anyone other than authorized by the manufacturer.
- Freight and Insurance cost for the warranty service.

**DISCLAIMER OF IMPLIED WARRANTIES: LIMITATION OF REMEDIES**  
CUSTOMER'S SOLE AND EXCLUSIVE REMEDY UNDER THIS LIMITED WARRANTY SHALL BE PRODUCT REPAIR OR REPLACEMENT AS PROVIDED HEREIN. CLAIMS BASED ON IMPLIED WARRANTIES, INCLUDING WARRANTIES OF MERCHANTABILITY OR FITNESS FOR A PARTICULAR PURPOSE, ARE LIMITED TO ONE YEAR OR THE SHORTEST PERIOD ALLOWED BY LAW, BUT NOT LESS THAN ONE YEAR. WHYNTER SHALL NOT BE LIABLE FOR CONSEQUENTIAL OR INCIDENTAL DAMAGES SUCH AS PROPERTY DAMAGE AND INCIDENTAL EXPENSES RESULTING FROM ANY BREACH OF THIS WRITTEN LIMITED WARRANTY OR ANY IMPLIED WARRANTY. SOME STATES AND PROVINCES DO NOT ALLOW THE EXCLUSION OR LIMITATION OF INCIDENTAL OR CONSEQUENTIAL DAMAGES, OR LIMITATIONS ON THE DURATION OF IMPLIED WARRANTIES. SO THESE LIMITATIONS OR EXCLUSIONS MAY NOT APPLY TO YOU. THIS WRITTEN WARRANTY GIVES YOU SPECIFIC LEGAL RIGHTS. YOU MAY ALSO HAVE OTHER RIGHTS THAT VARY FROM STATE TO STATE.

To obtain service or information, contact

Whynter LLC via email at [support@whynter.com](mailto:support@whynter.com) or call

866-WHYNTER.

Product contents and specifications may change without notice. Copyright © 2018 Whynter LLC