







STEP 3

In order to prevent product tip over, please follow the instruction below to secure the unit to the wall.

Hardware List			Qty
 WALL PLUG	 EYELET SCREW	 CABLE TIE	1SET
 1/4" DRILL BIT	 WALL PLUG	 EYELET SCREW	

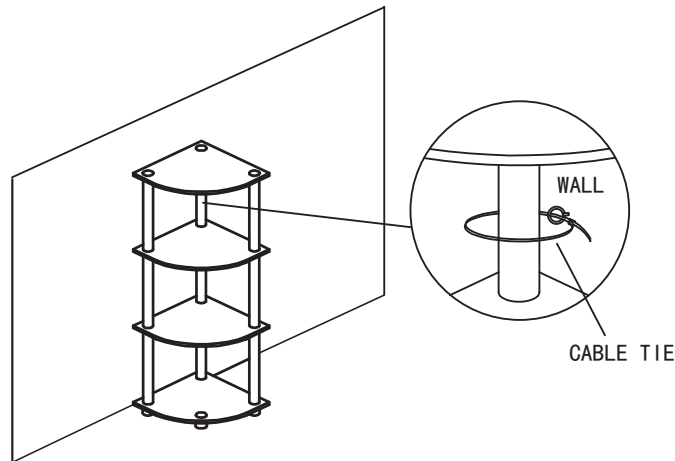

Recommended Maximum Weight

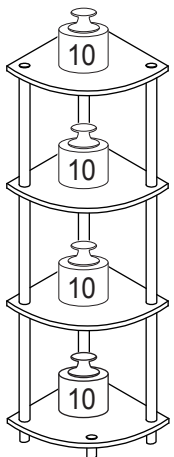

*Unit in Pound(lbs)

WARNING:

>This unit has been designed to support the maximum loads shown. Exceeding these load limits could cause sagging, instability, product collapse, and/or serious injury.

>DO NOT allow children to climb on unit.

>Put heavier items on lower shelves.



Assembly Instruction

Furinno Turn-N-Tube 4-Tier Corner Display Rack Multipurpose Shelving Unit

MODEL : 12078

00:10

Approx. 10 minutes



Recomm. 1 Person

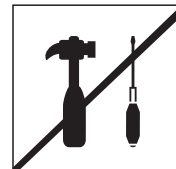

No Tools Required

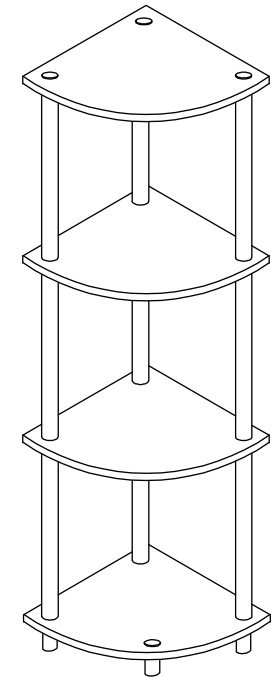





Customer Support

NEED HELP? For replacement requests or product inquiries, please contact our Customer Service Team by emailing us at support@furinno.com. Thank you for selecting Furinno!

www.furinno.com

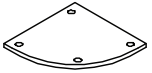

No	Hardware List	Qty
1	Long Pole 	9pcs
2	Top Cap 	4pcs
3	Round Leg 	4pcs

No	Parts List	Qty
A	Shelf Panel 	3pcs
B	Bottom Panel 	1pc

Hardware List	Qty
 WALL PLUG  EYELET SCREW  CABLE TIE	1Set

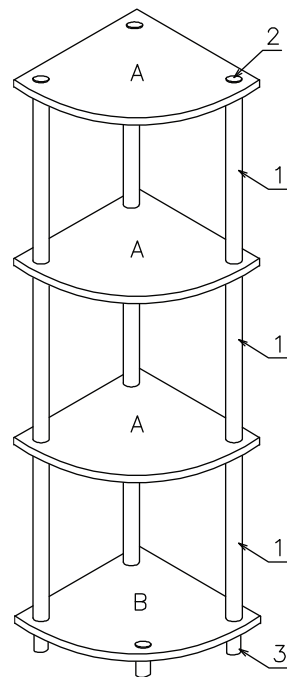
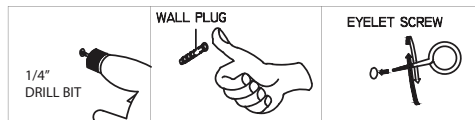





USEFUL HINTS BEFORE YOU START:

1. Read each step carefully before starting.
2. It is important that each step is performed in correct order to avoid difficulties.
3. Identify, sort and count the parts before assembly.
4. Assemble your furniture on packaging cardboard to prevent scratch or damage.
5. Clean the product with mild cleanser using soft damped cloth. Do not use harsh or abrasive cleanser.
6. Using incompatible hardware might cause damage to product.

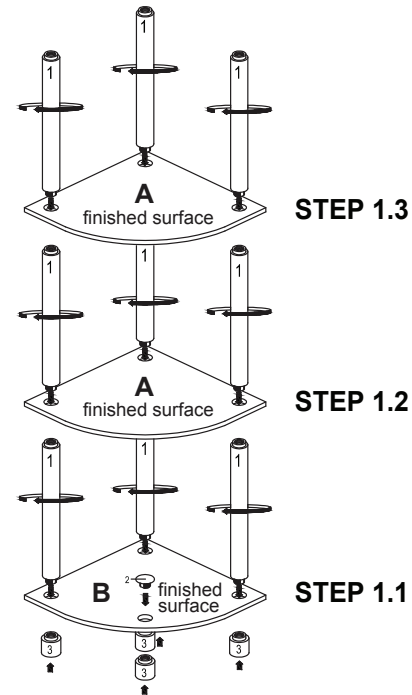
STEP 1

- 1.1 Attach Long Pole (1), Top Cap (2) and Round Leg (3) to Bottom Panel (B), as shown:
- 1.2 Attach Shelf Panel (A) and tighten Long Pole (1), as shown:
- 1.3 Attach Shelf Panel (A) and tighten Long Pole (1), as shown:



-  ① Long Pole - 9pcs
-  ② Top Cap - 1pc
-  ③ Round Leg - 4pcs

STEP 2

Attach Top Panel (A) and tighten Top Cap (2), as shown:

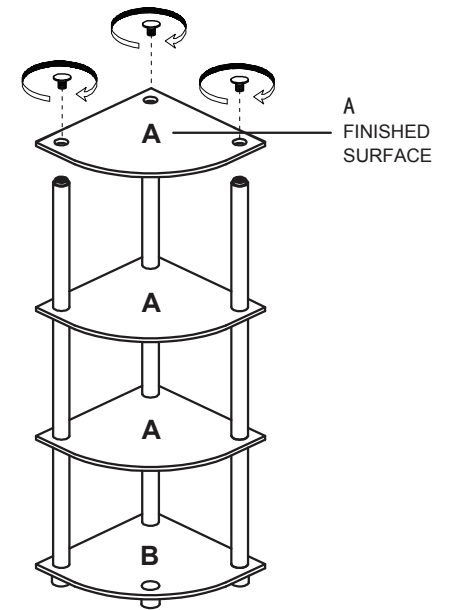

-  ② Top Cap - 3pcs