

# 6x6 Maximizer Storage Shed Assembly Manual

Version #13  
September 26, 2019

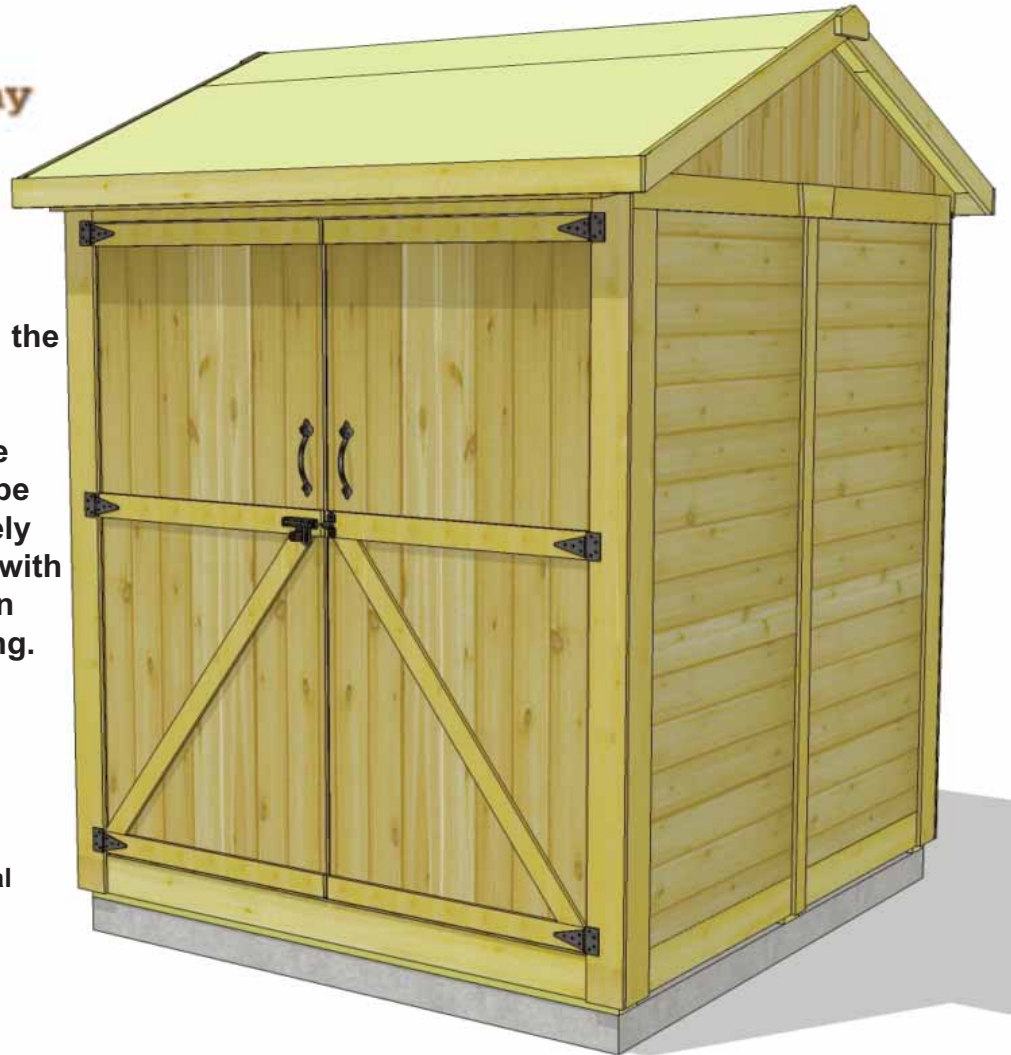

Thank you for purchasing a 6x6 Maximizer Storage Shed. Please take the time to identify all the parts prior to assembly.

Please Note- Roofing Shingles are NOT included in this kit. You will be required to purchase approximately 60 Square Feet of shingles along with the appropriate hardware to fasten shingles to plywood roof sheathing.

#### Safety Points and Other Considerations

Our products are built for use based on proper installation and normal residential use, on level ground. Please follow the instruction manual when building your shed and retain the manual for future maintenance purposes.

Some of the safety and usage measures you may wish to consider include:

- snow load ratings vary by geographical location. If heavy or wet snowfall occurs, it is advisable to sweep the snow off the roof(s).
- if the product is elevated, any structural and building code requirements are solely the customer's responsibility, and should be abided by.
- in high or gusty wind conditions it is advisable to keep the structure securely grounded.
- have a regular maintenance plan to ensure screws, doors, windows and parts are tight.

Customer agrees to hold Outdoor Living Today Partnership and any Authorized Dealers free of any liability for improper installation, maintenance and repair.

**In the event of a missing or broken piece, simply call the Outdoor Living Today Customer Support Line @ 1-888-658-1658 within 30 days of the delivery of your purchase. It is our commitment to you to courier replacement parts, free of charge, within 10 business days of this notification. Replacement parts will not be provided free of charge after the 30 day grace period.**

**Thank you for purchasing a 6x6 Maximizer Storage Shed**  
**Please take the time to identify all the parts prior to assembly.**

## **Parts List:**

### **A. Floor Section**

- 2 - 35" x 75" - Floor Joist Frames
- 2 - 5/8" x 34 7/8" x 74 7/8" - Plywood Floor
- 4 - 1 1/2" x 3 1/2" x 72" - Floor Joists
- 3 - 1 1/2" x 3 1/2" x 70" Floor Runners

### **B. Wall Section**

- 6 - 35" x 75" - Wall Panels - (Walls with Bottom Plates Unattached)
- 6 - 1 1/2" x 2 1/2" x 35" - Bottom Wall Plates

### **Door Jambs & Header**

- 2 - 2 1/2" x 3 7/8" x 73" - Vertical Door Jamb
- 1 - 2" x 2 1/2" x 71 3/4" - Door Header
- 1 - Left Side Door
- 1 - Right Side Door
- 1 - 2 1/2" x 1 1/2" x 64" - Horizontal Door Stop with Dado cut
- 1 - 2 1/2" x 3/4" x 62 1/2" - Door Threshold
- 1 - 1/2" x 2 1/2" x 71" - Interior Door Flange
- 2 - 1/2" x 2 1/2" x 71" - Door Stops

### **Gable Walls**

- 2 - Gable Walls - Triangular Shaped

### **Top Wall Plates**

- 2 - 3/4" x 2 1/4" x 65" - Front & Rear Top Plates  
( Angle cut on 1 edge)
- 2 - 3/4" x 2 1/2" x 75" - Side Top Plates (Angle cut on ends)
- 2 - 1 1/2" x 5 1/2" x 5 1/2" Front Triangular Corner Brackets

### **C. Rafter and Roof Section**

- 10 - 1 1/2" x 3 1/2" x 45" - Roof Rafters with angled ends
- 4 - 3/4" x 1 1/2" x 42" - Facia Nailing Strips
- 2 - 3/4" x 4 1/2" x 70" - Roof Ridge Boards
- 2 - 1/2" x 4 1/2" x 70" - Soffits
- 2 - 5/8" x 78" x 45 1/4" - Plywood Roof
- 1 - 3/4" x 3 1/2" x 48" - Gusset

### **D. Miscellaneous Section**

#### **Bottom Skirting**

- 6 - 1/2" x 4 1/2" x 34 3/4" - Side and Rear Bottom Skirting
- 1 - 3/4" x 4 1/2" x 64" - Front Bottom Skirting

#### **Corner & Sidewall Trim**

- 2 - 7/8" x 2 1/2" x 75" - Rear Filler Trim
- 2 - 3/4" x 4 3/8" x 79" - Front Wide Trim
- 2 - 1/2" x 4 1/2" x 77 1/2" - Side Front Wide Trim
- 2 - 1/2" x 4 1/2" x 77 1/2" - Side Rear Wide Trim
- 4 - 1/2" x 4 1/2" x 37 7/8" - Horizontal Gable Trim
- 3 - 1/2" x 2 1/2" x 79" - Narrow Trim (Rear Wall)
- 2 - 1/2" x 2 1/2" x 77 1/2" - Narrow Trim (Side Walls)
- 1 - 1/2" x 1 1/4" x 64" - Above Door Trim

#### **Facia Trim**

- 2 - 3/4" x 3 1/2" x 79 1/2" - Front and Rear Facia
- 4 - 3/4" x 3 1/2" x 46" - Side Facia - Angle cut both ends - ( 2 right / 2 left)

#### **\*\*Miscellaneous Pieces**

- 2- Pentagon Facia Plate
- 2 - Horizontal Gable Detail Plates (See Step 54)
- 1 pc - Spare Wall Siding
- 2 pc - Cedar Shingles used for Shims

# 6 x 6 MAXIMIZER HARDWARE PACKAGE

## Screws and Nails

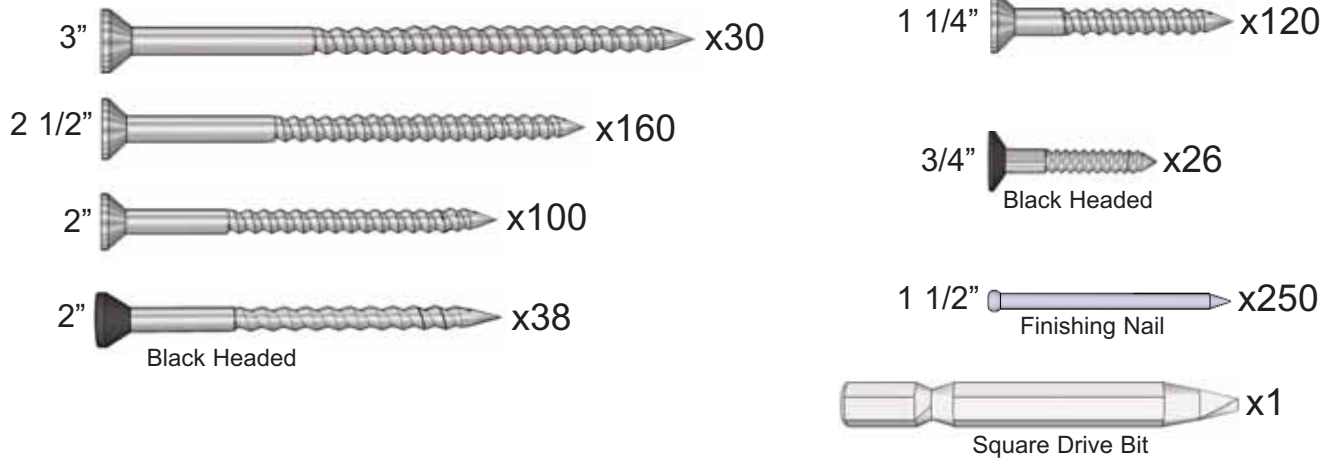

## Individual Hardware Components (not actual size)

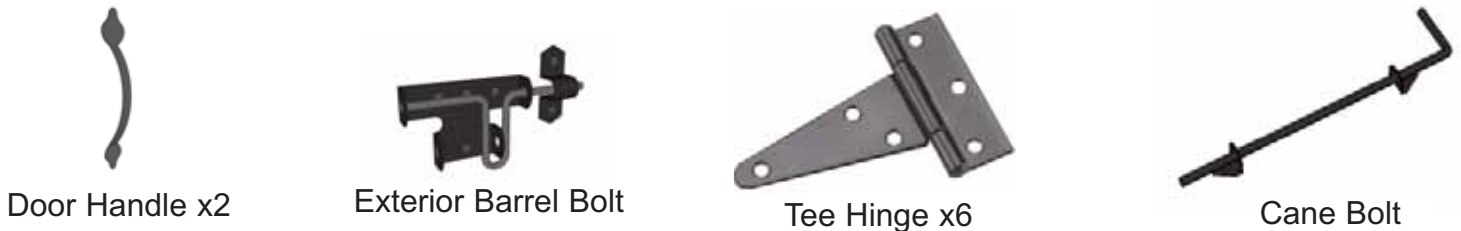

## Tools Required



## Safety Equipment Required



# What Can I Do Before My Shed Arrives?

Before starting your project become familiar with this assembly manual and determine if you can complete the project yourself or will require a professional contractor. Please note that certain counties and municipalities require building permits prior to installation. We recommend to all consumers that they check with their local county/municipality for these specifics prior to purchasing any of our products since this is your sole responsibility.

Prior to the product arriving, clear the construction area. Remove all debris; roots, grass, rocks, etc. Make sure the ground slopes away from the site at least 10 feet in all directions. If necessary, build up the soil in the center of the site and slope away for the high point to provide drainage. Fill in any low spots within the perimeter of the site. A slope of 1/8 inch per foot is enough to prevent water accumulation. We recommend excavating the site 4-6 inches deep and laying gravel or crushed rock where drainage may be a concern.

## What type of foundation should I use?

**Patio Stone Foundation :** If the ground is stable and has sufficient drainage, you can set patio stones directly on firm compacted soil. If not, consider laying down sand and then gravel or crushed rock. Excavate the site making it about 12" wider and longer than the floor footprint. Excavate down approximately 4-6 inches deep. Lay 1-2 inches of sand first and then fill with 3-4 inches of gravel or rock for good drainage and support. Most of our sheds and playhouses include floors with support runners. Support each runner with 4-5 patio stones (less for smaller sheds). Patio stones can be anything from a mid size brick to a round our square 12" long by 1 1/2" thick stone. Place stones directly under the floor runners, check for level and adjust height as necessary. Having a solid and level foundation is the most critical piece of work you can do to make the project go smoothly. Most of this work can be done prior to your shed arriving!

**4x4 Pressure Treated Beam Foundation :** You can build directly on pressure-treated beams or railroad ties laid on a properly prepared construction site as mentioned above. Run beams perpendicular to floor runners. Use a 2x4 straight piece of lumber on edge and a carpenter's level to position correctly. To prevent the beams from shifting, secure them with 1/2 inch rebar inserted through holes drilled in the beams and driven 3 to 4 feet into the ground. Leave each side or end of the foundation open to promote drainage and air circulation beneath the floor. Consider using a wire mesh or equivalent to prevent pesky critters from gaining access on ends.

**Concrete - Slab Foundation :** Typically a slab 3-4 inches thick laid over a sub-base of 4 inches of gravel or crushed rock is sufficient but may vary depending on your geographic location. Using either mix your own concrete or having it delivered by truck, ready to pour, depends on how much time and effort you have to dedicate to the project. In any event, make sure you excavate the slab area to a depth 6 inches. This would put the finished slab surface approximately 2 inches above ground (remember you will be using 4 inches of gravel as your subbase). For example, a slab for our 8'x12' SpaceMaker Shed will require approximately 1 cubic yard of premixed concrete.

For more detailed information on how to pour your concrete-slab foundation or any other questions regarding specifications, foundations and permits, please visit our website at [www.outdoorlivingtoday.com](http://www.outdoorlivingtoday.com) or call our Customer Support Line at **1-888-658-1658** to speak with a Product Representative.

\* Please note that all measurements in our Detailed Assembly Manuals may be subject to change without notice. Please confirm exact foundation size with Outdoor Living Today if you have any concerns or questions.



# A. Floor Section

Exploded view of all parts necessary to complete Floor Section. Identify all parts prior to starting.

Note, Floor Footprint is 70" wide x 75" deep.

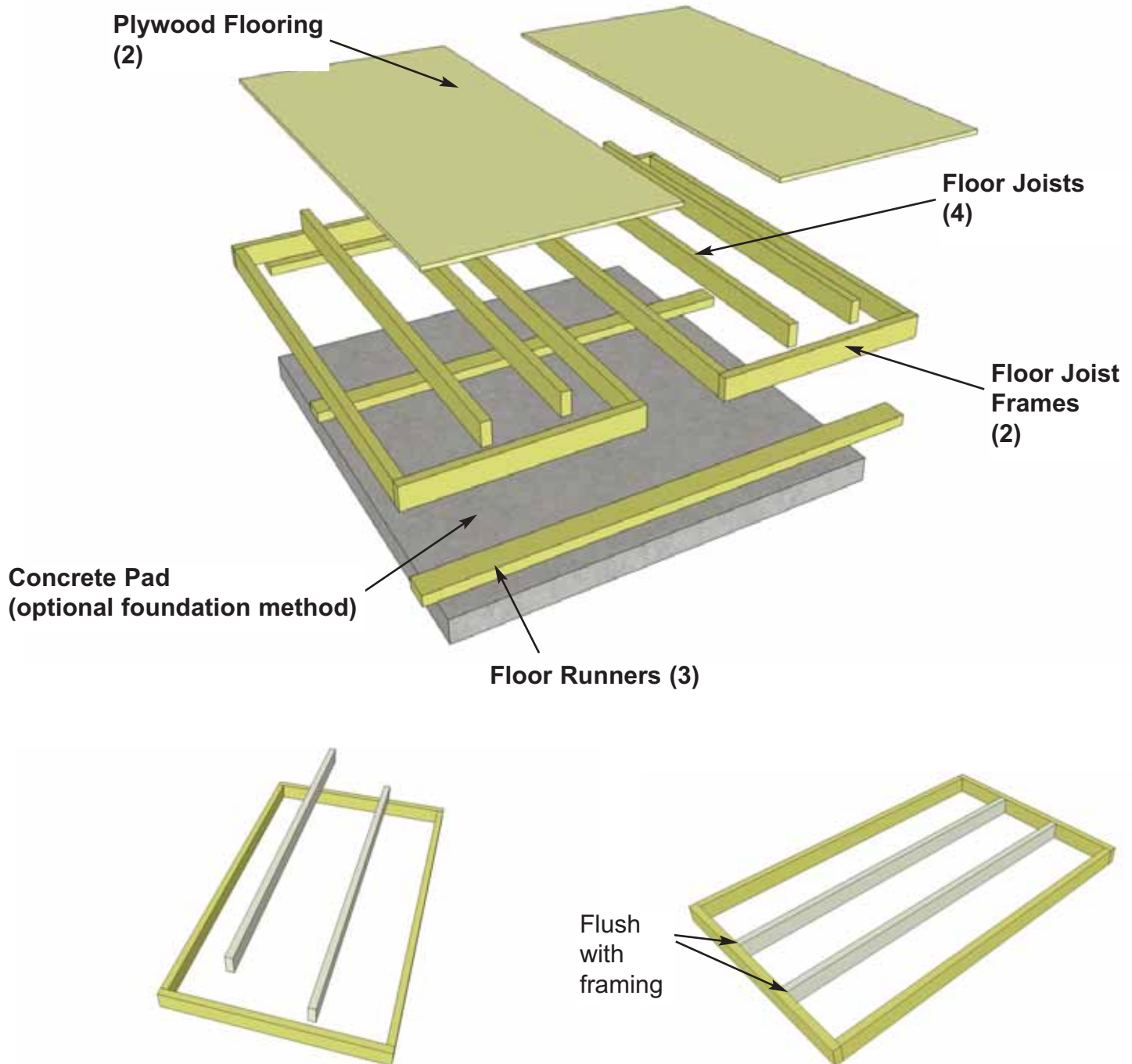

- 1.** Lay out one **Floor Joist Frame** and **2 Floor Joists** as illustrated above. Position Joists equally in Floor Joist Frame. Position Joist so flush with framing.

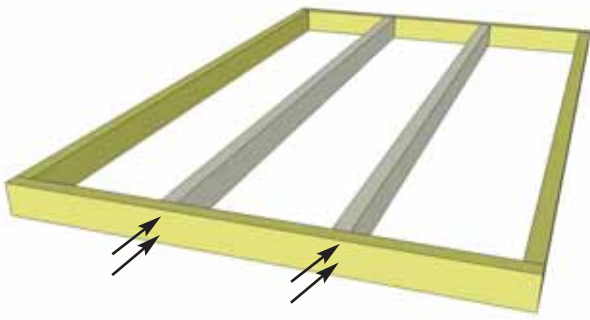

You can find the Square Drive Bit for the screws in with the Hardware Kit Bag.

**2.** When correctly positioned, attach each Joist with 4 - 2 1/2" screws (2 per end). Complete Joist attachments for 2nd Floor Frame.

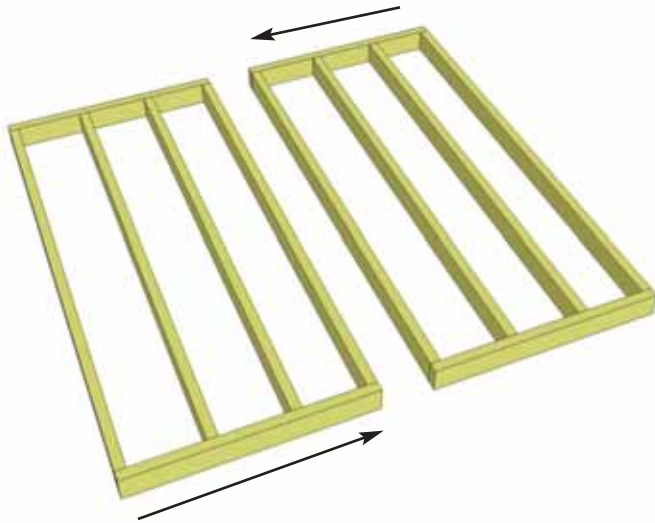

**3.** Lay out both completed Floor Joist Frames as illustrated at left.

**4.** Align Floor Joist Frames together as shown below. Screw Sections together with 8 - 2 1/2" screws.

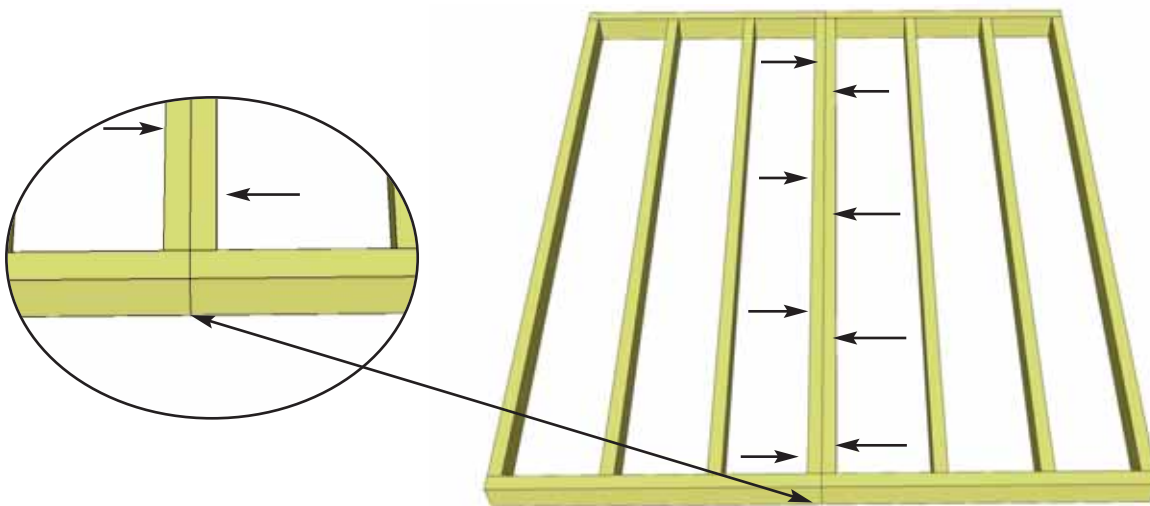

**5.** When completed, your floor footprint should be 70" wide x 75" deep.

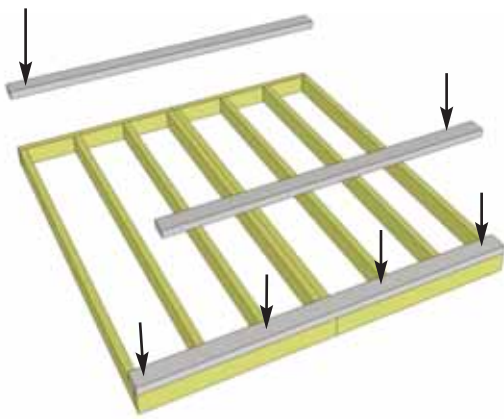

**6.** Attach **Floor Runners** to completed floor frame. There are 3 floor runners per 70" side. Use 8 - 2 1/2" screws per Runner.

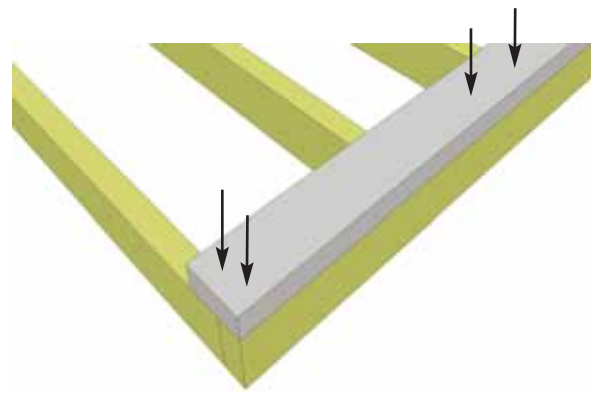

**7.** Make sure Runners are flush with outside and front and rear floor framing but not overhanging.

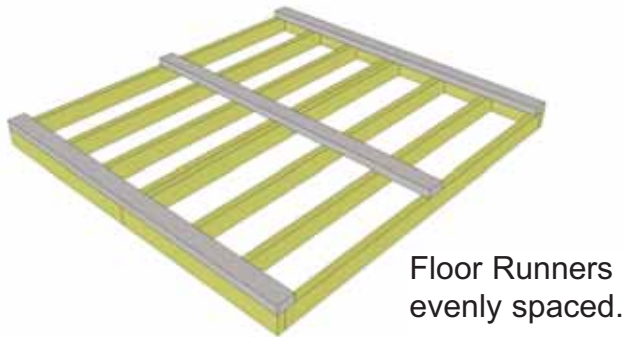

**8.** Complete all Floor Runners.

### Foundations

**Note:** The floor will be flipped over and floor runners will sit on your foundation. It is important to note that having a level foundation is critical. Choosing a foundation will vary between regions. Typical foundations can be concrete pads or patio stones positioned underneath the floor runners.

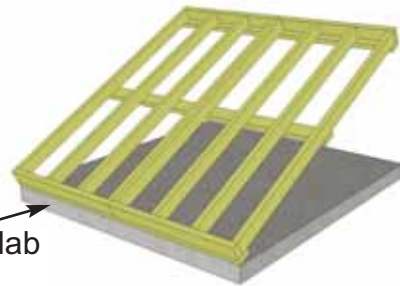

**9.** With Floor Runners attached, carefully flip the floor over and place on your foundation. **Caution-** you will need 2 people to assist you. Be careful when laying floor down not to bend or twist floor. When in place, level floor completely. **Measure diagonal** in both directions to confirm square. Both should be approximately 102 1/2". Adjust floor if necessary.

**Measure Diagonal**

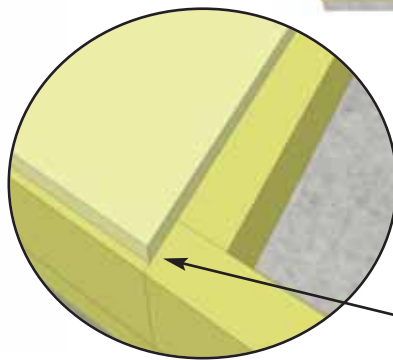
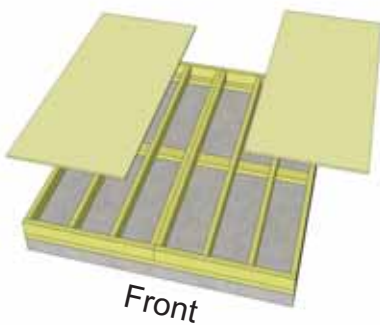
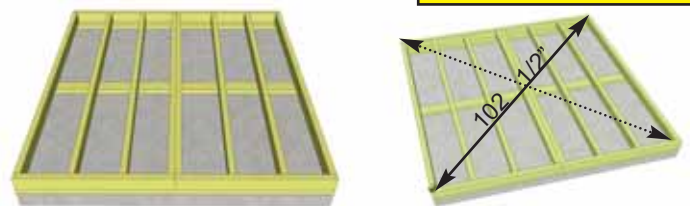

**10.** Position **Plywood Floor** pieces (2) on top of completed floor frames. The Plywood is cut slightly smaller than floor framing. Keep plywood seams tight.



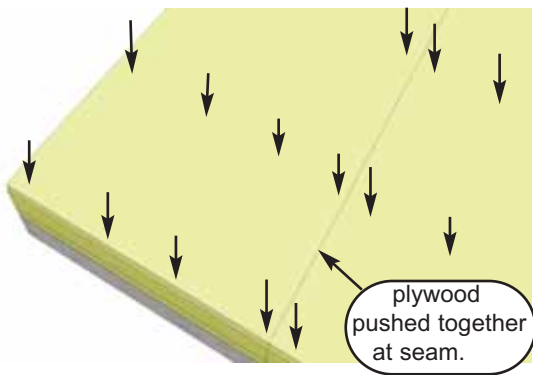

**11.** With Plywood positioned correctly on floor framing, attach using 16 - 1 1/4" screws per sheet.

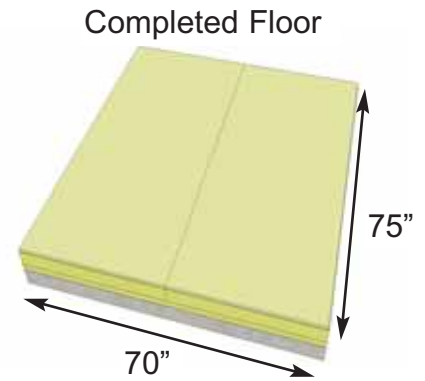

## B. Wall Section

Exploded view of all parts necessary to complete the Wall Section. Identify all parts prior to starting.

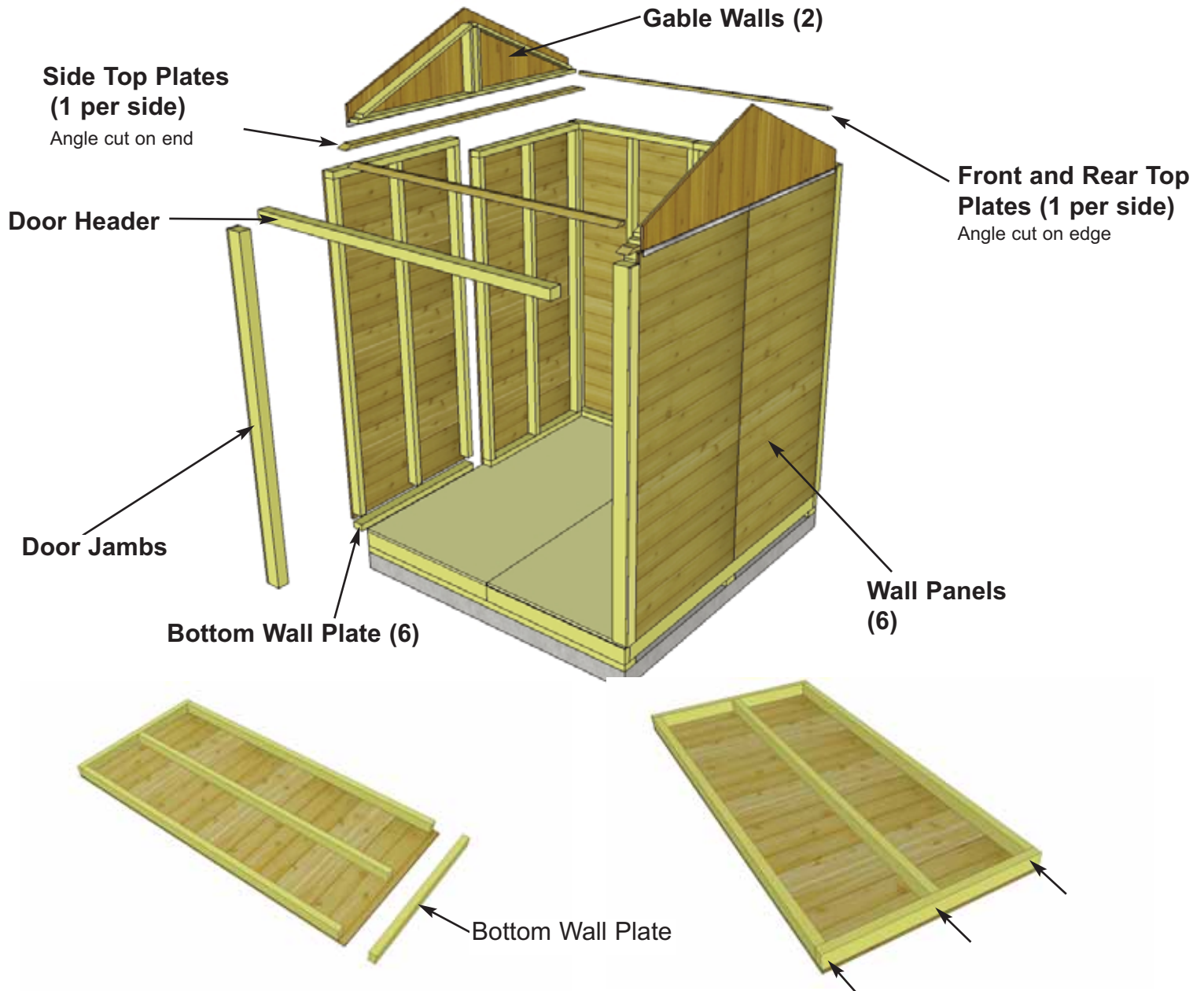

**12.** Starting with **Solid Wall Panels**, carefully lay panel face down. Position and attach **Wall Plate** to bottom of wall studs of each wall panel with 3 - 2 1/2" screws. Position plates flush with framing.



Plywood Floor shown in Floor Section B illustrations may not be exactly as shipped.

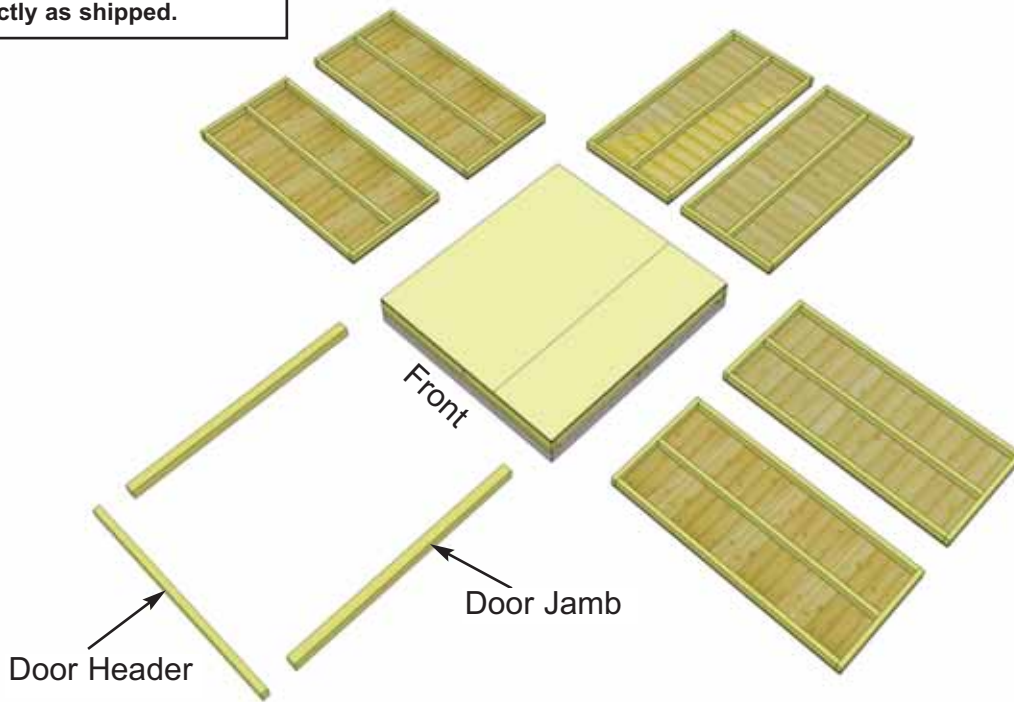

**13.** Lay out all the wall panels and become familiar with their location.

Make sure to position panels right side up so water is directed away from and not into shed.  
Note, to determine correct alignment, the attached Bottom Wall Plate of wall panel will be sitting on floor.

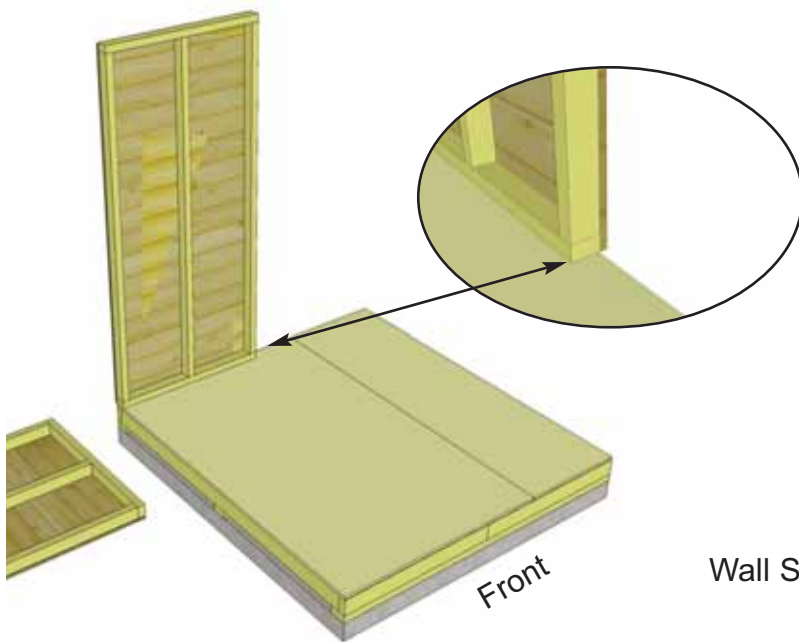

**14.** Starting at Rear Corner, position a Wall Panel on top of plywood floor. The Wall Panel bottom framing will sit flush with Floor Framing. Wall siding will overhang the floor.

**15.** The wall panel will sit flush at the end of the plywood floor with the side wall panels sandwiched between them.

**Note:** Siding will overhang the floor by approx. 1/2"

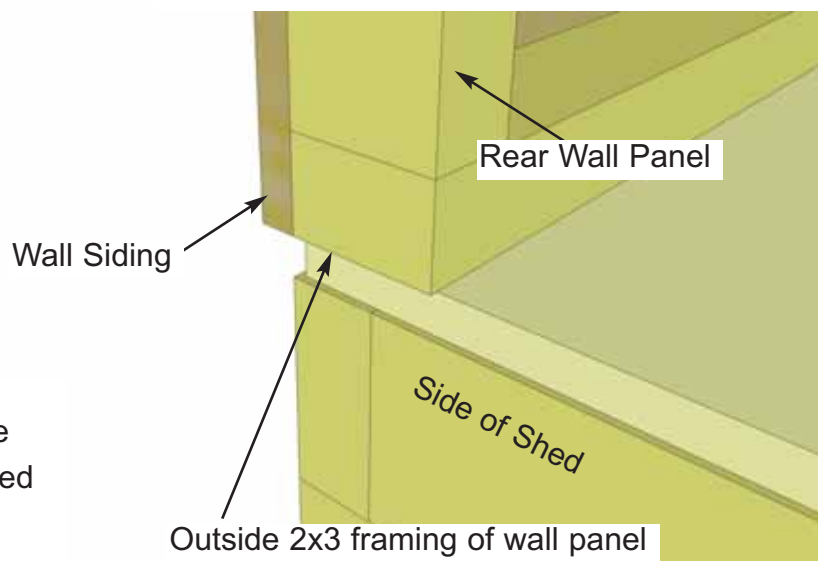

Outside 2x3 framing of wall panel will sit even with outside of floor framing with plywood flooring slightly inset.



**Optional** - Caulking seams will help prevent moisture from entering at seam.  
**Caulking not included in kit.**

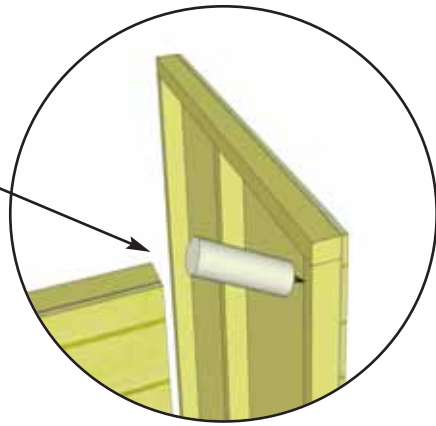

**16.** Position side wall into place on plywood floor. Butt both vertical wall studs of side and rear walls together and attach with 3 - 2 1/2" screws. Screw at the bottom, middle and top of stud to secure properly.

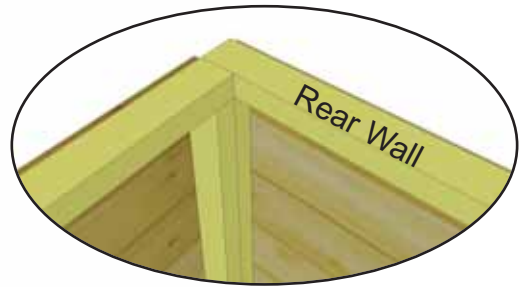

**Do Not Attach Walls To Floor until Step 28.**

**17.** With the corner wall attachment complete, position a second side wall panel in place.

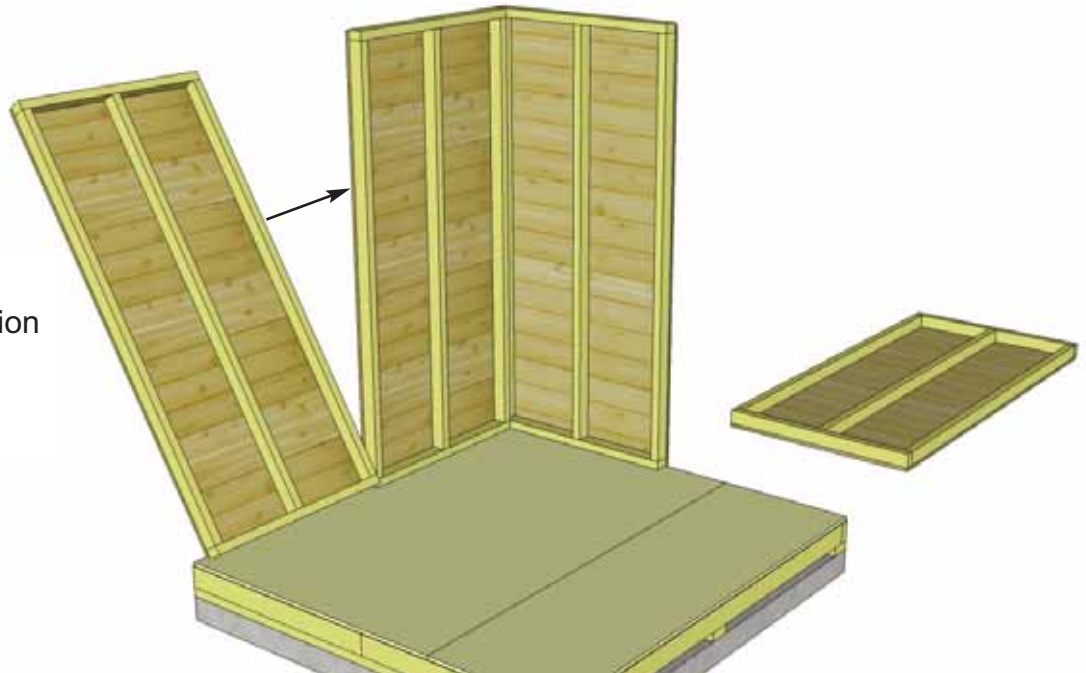



**18.** Align vertical wall studs of both side wall panels together and attach with 3 - 2 1/2" screws. Wall siding should overhang floor by approximately 1/2". Position 2nd rear wall panel as previously described.

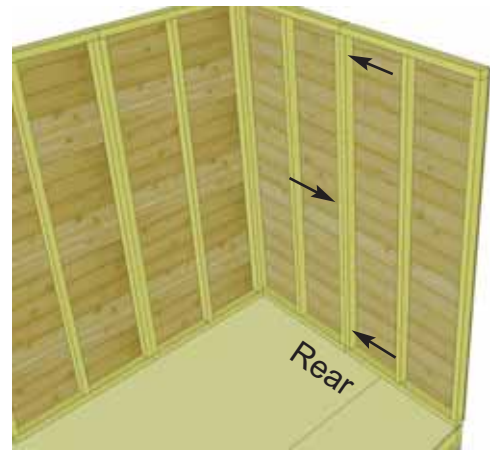
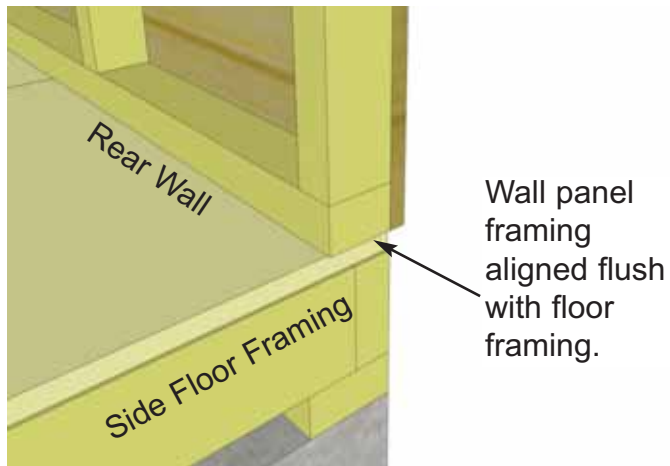

**19.** Align wall panel framing flush with floor framing and attach vertical wall studs together as per **Step 18**.

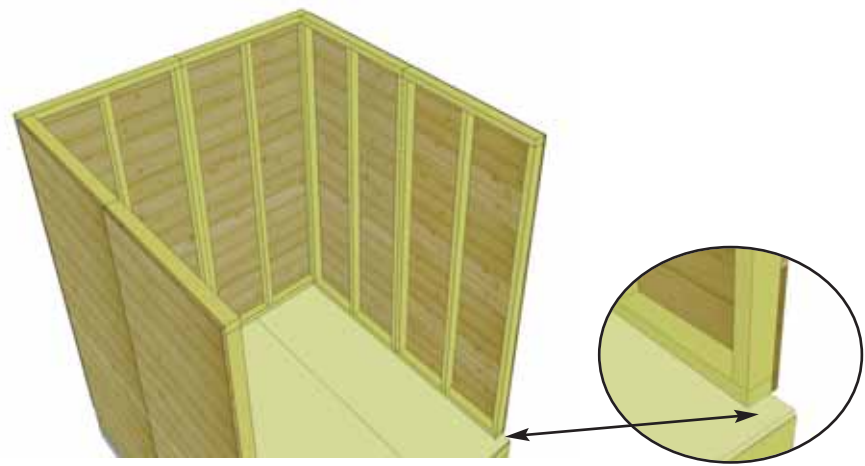
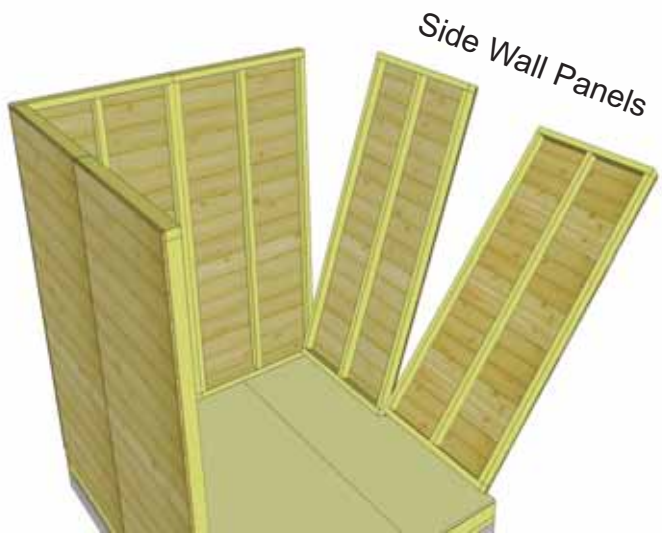

**20.** Position and attach remaining side wall panels together as per **Steps 16-18**.



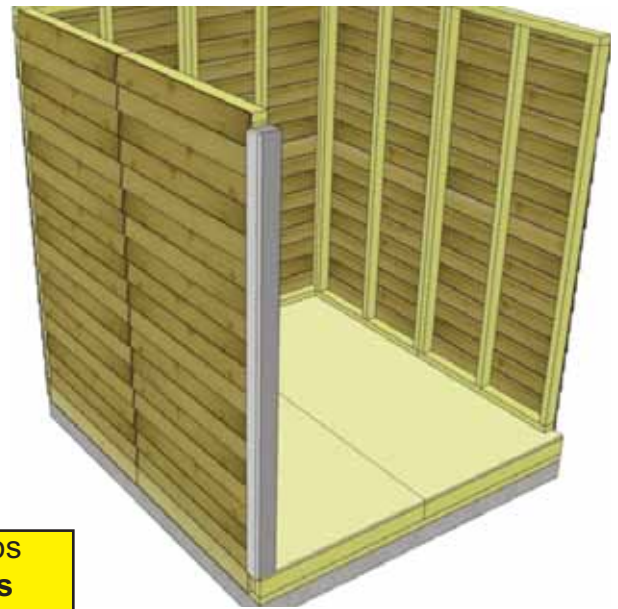
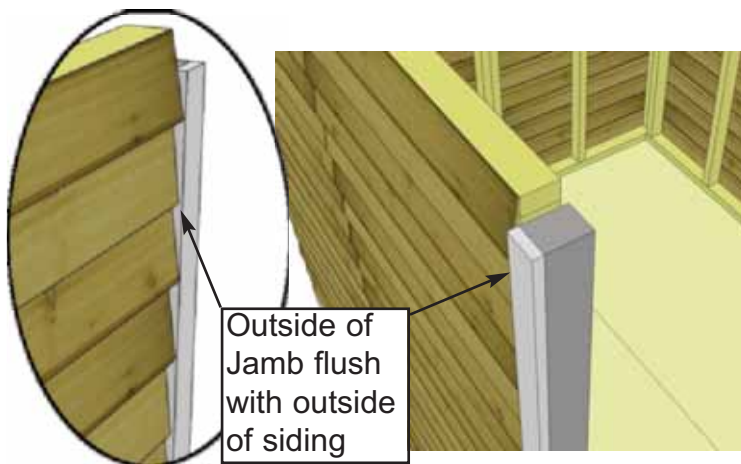

**21.** Locate Door Jambs. Align so attached filler strip is facing to the outside. Position outside of Jamb flush with outside of siding. At the floor, Jamb should be flush with floor framing.

When aligning Jambs and Header in **Steps 21-23**, do a dry run first to confirm spacing. Tack jambs with only a few screws initially. Jambs should be 64" apart when measured inside to inside.



**22.** Attach Door Jamb to vertical wall stud with 4 - 2 1/2" screws. Complete both Door Jambs.

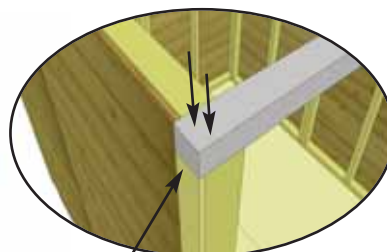
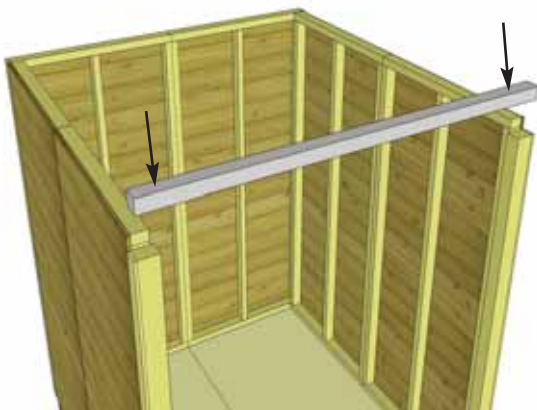

End of Header flush with outside of Door Jamb.



**23.** Position and attach the Door Header flush to outside end of Door Jamb with 2 - 2 1/2" screws per side. Important- Drill 1/8" pilot holes in end of Door Header to prevent wood from splitting.



On ends, screwing on slight angle provides more strength

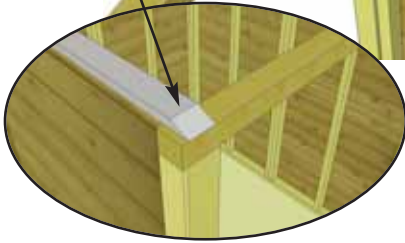

Top Plate aligned flush with inside of wall framing.

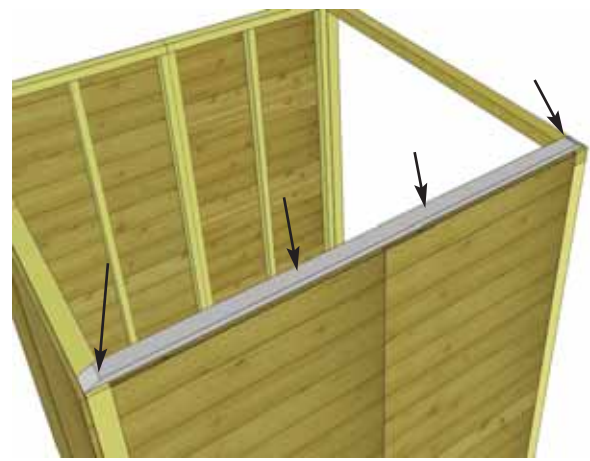

**24.** Position one **Side Top Plate** (angle cut on both ends) on top wall framing. Top Plate should be evenly spaced from front to back and aligned flush with the inside of wall framing. Attach into wall framing with 4 - 2" screws.

**25.** Position a **Front Top Plate** (angle cut on edge) on to top of wall framing. Butt the straight cut end up to Side Top Plate and align flush with the inside of Door Header. When correctly aligned, attach into Header with 4 - 2" screws.

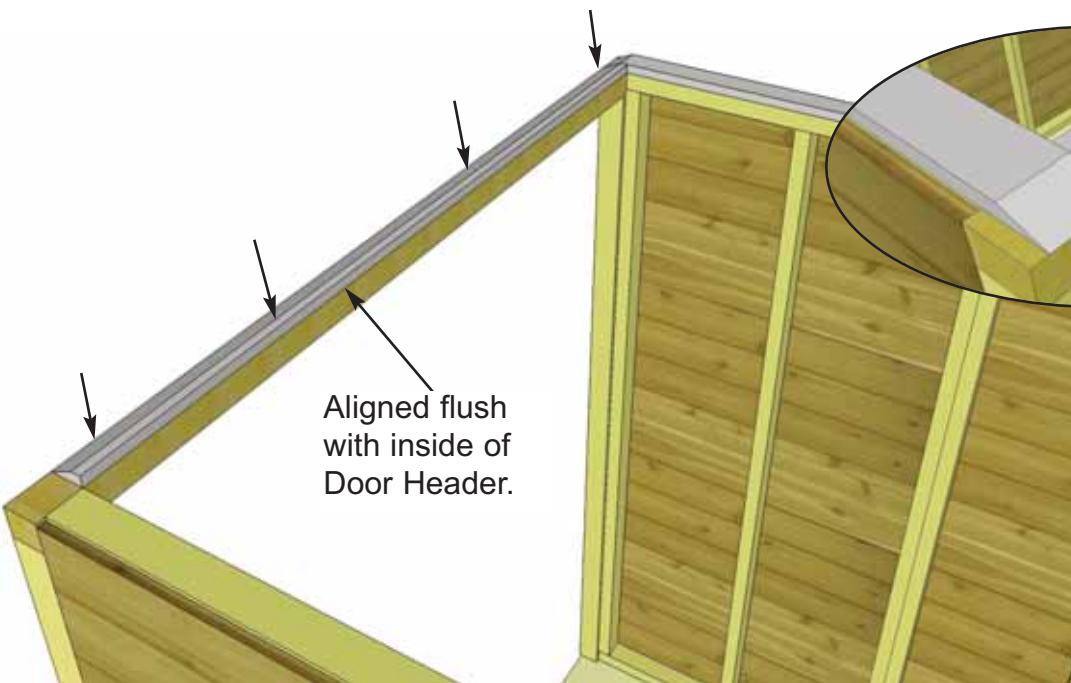

Aligned flush with inside of Door Header.

Front Top Plate butted up against Side Top Plate with angled edge to outside.



**26.** Complete remaining Side and Rear Top Plate attachments as per **Steps 24-25.**

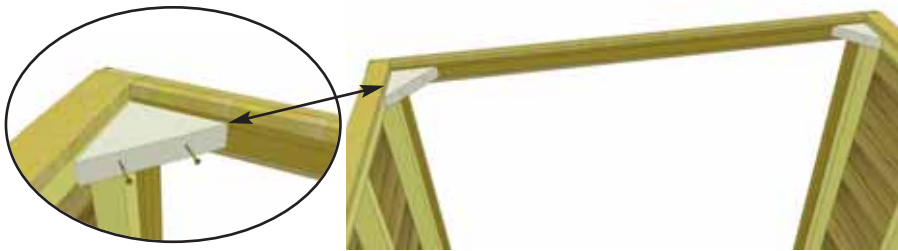
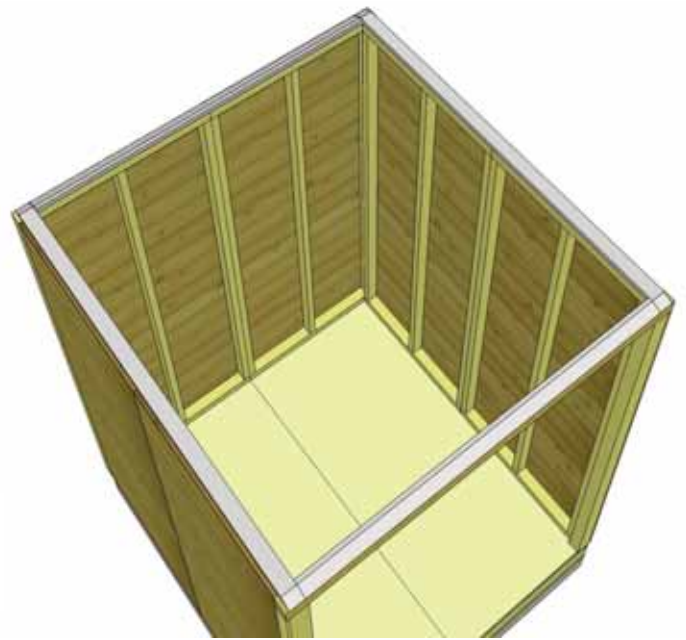

**26a.** Attach front **Front Triangular Corner Brackets - 1 1/2" x 5 1/2" x 5 1/2"** to header and wall frame with **2 - 2 1/2" screws** per piece.

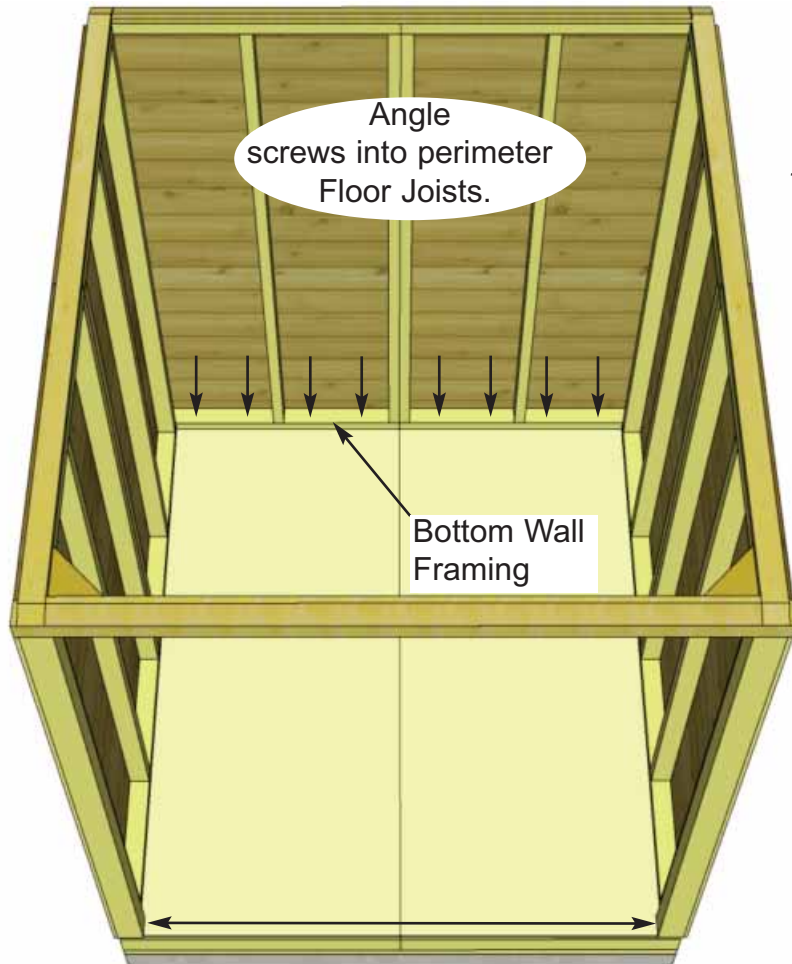

Angle screws into perimeter Floor Joists.

Bottom Wall Framing

**27.** When all Walls and Top Plates are attached together, check wall and floor alignment. Bottom wall framing should sit flush with outside of floor joists. See **Steps 15-20** for correct alignment.

**Confirm Door Jambs are 64" apart at top and bottom of door opening.**

When positioned correctly, fasten bottom wall plates to floor using **4 - 2 1/2" screws** per wall panel.

**Optional - Caulking** seams will help prevent moisture from entering at seam.  
**Caulking not included in kit.**

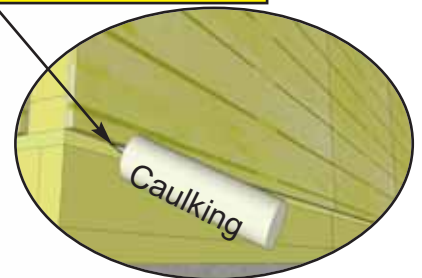

Confirm 64" Wide between Door Jambs



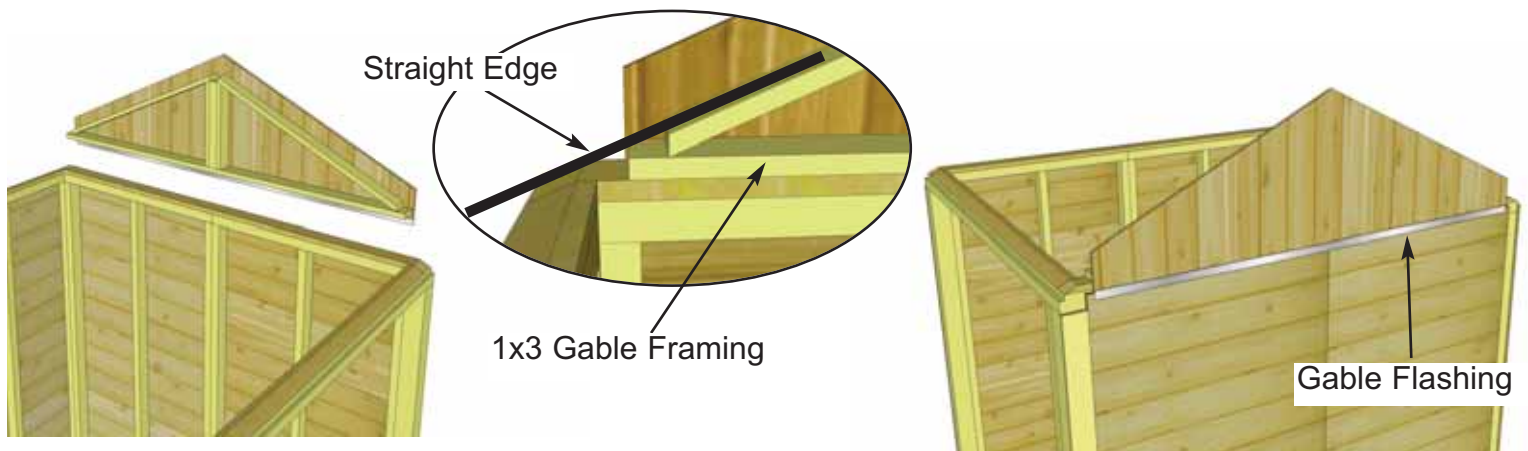

**28.** Place Gable so framing sits flush with the inside of the top plate. Center from front to rear using a Straight Edge to confirm angle of gable frame and Top Plate line up. Adjust gable accordingly. From the outside, make sure gable flashing overhangs wall siding.



**29.** Temporarily attach Gable to walls and top plate with 2 - 2" screws. Screw from the bottom of gable framing down into Top Plate and Wall. Gables may need slight adjustment in **Step 40** and then be completely attached with an additional 6 - 2" screws. Position 2nd Gable on side walls.



**30.** Position and temporarily attach 2nd Gable as per **Steps 28-29**.

# C. Rafter and Roof Section

Exploded view of all parts necessary to complete the Roof Section.  
Identify all parts prior to starting.

Plywood  
Roof Panels  
(2)  
78" x 45 1/4"

Ridge Boards (2)  
3/4" x 4 1/2" x 70"

Roof  
Gusset

Soffits (2)  
1/2" x 4 1/2" x 70"

Roof  
Rafters  
(10)

3/4" thick Ridge Board

45" Long Rafters

**31.** Locate 5 - 1 1/2" x 3 1/2" x 45" long Rafters, 1 - 1/2" x 4 1/2" x 70" Soffit and 1 - 3/4" x 4 1/2" x 70" Ridge board. Evenly space out Rafters and lay out as illustrated to the left on a flat level surface.

1/2" thick  
Soffit



**32.** Attach Ridge Board to ends of both outside rafters with 2 - 2" screws per end. Drill 1/8" pilot holes in Ridge Board to prevent splitting. Measure and position interior Rafters as illustrated below. When positioned correctly, attach Ridge Board to remaining rafters with 2 - 2" screws /rafter end.

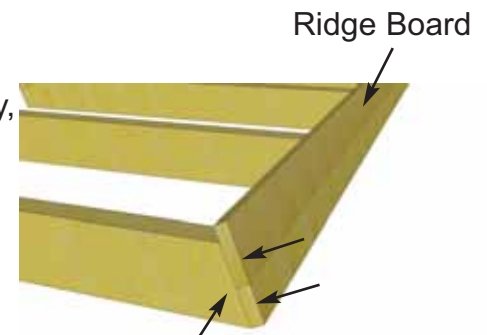

**Important:**  
Pilot Hole Ridge Board and Soffit prior to screwing to prevent splitting!

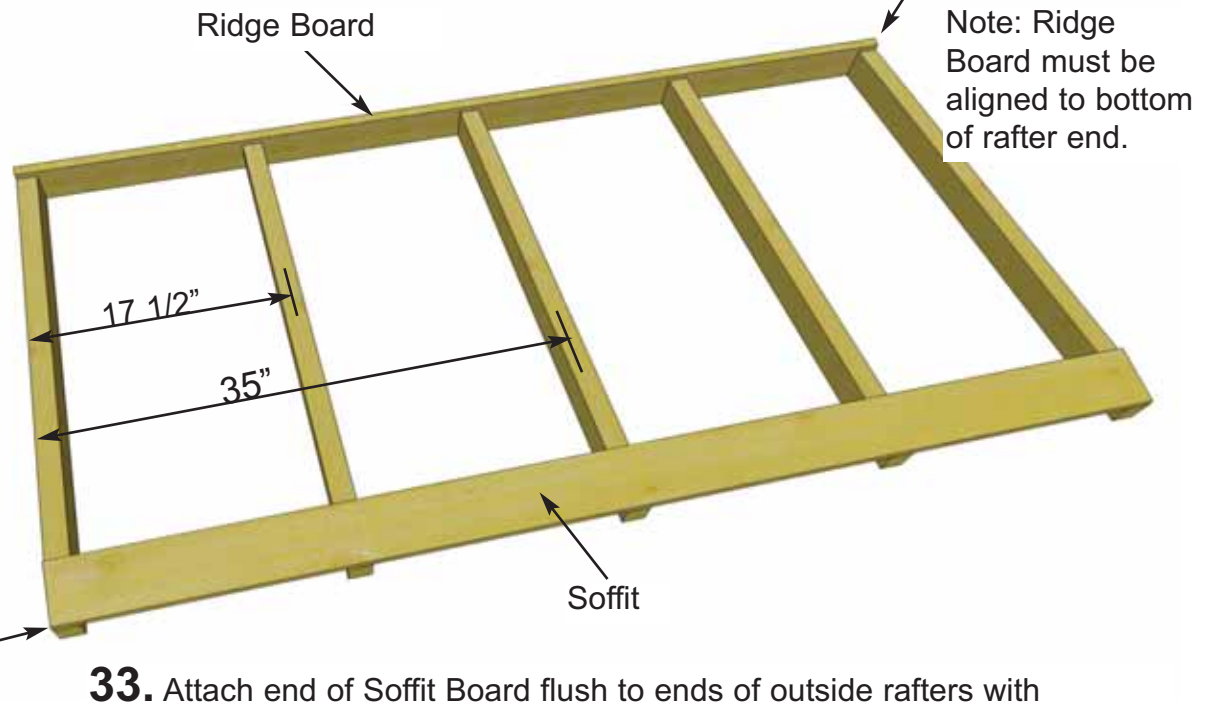

**33.** Attach end of Soffit Board flush to ends of outside rafters with 2 - 1 1/4" screws per rafter end. **Drill pilot hole in Soffit ends to prevent splitting.** Complete both outside Rafter / Soffit connections first. Measure and position interior Rafters as illustrated above. When positioned correctly, attach Soffits to remaining rafters with 2 - 1 1/4" screws /rafter. Flip completed rafter section over.



**34.** Complete 2nd Rafter section now as per **Steps 32 - 33.**

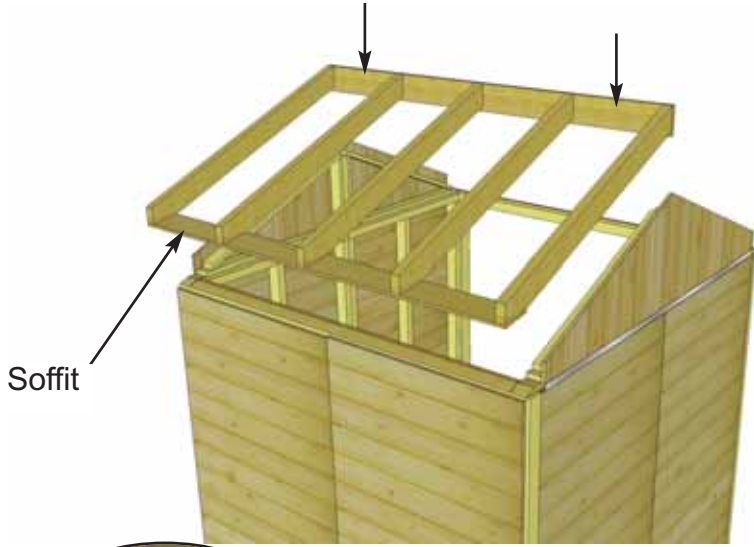

**35.** Starting at the rear, lift a completed rafter section up and place on gable framing.

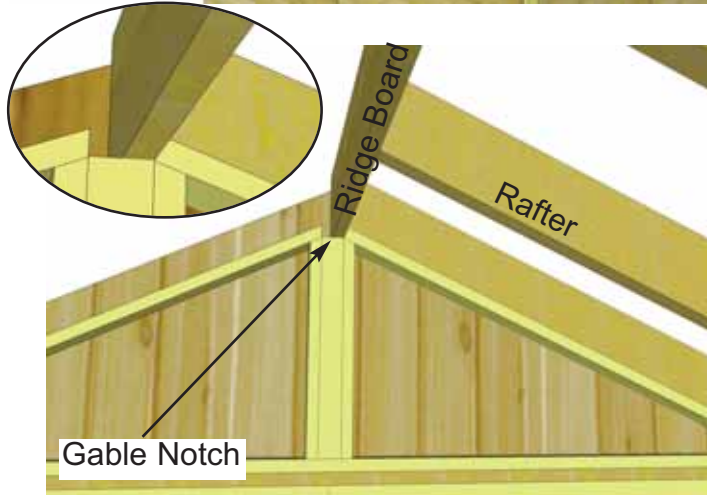

**36.** Slide Rafter Section up on gable framing until bottom of Ridge Board slips into gable notch.

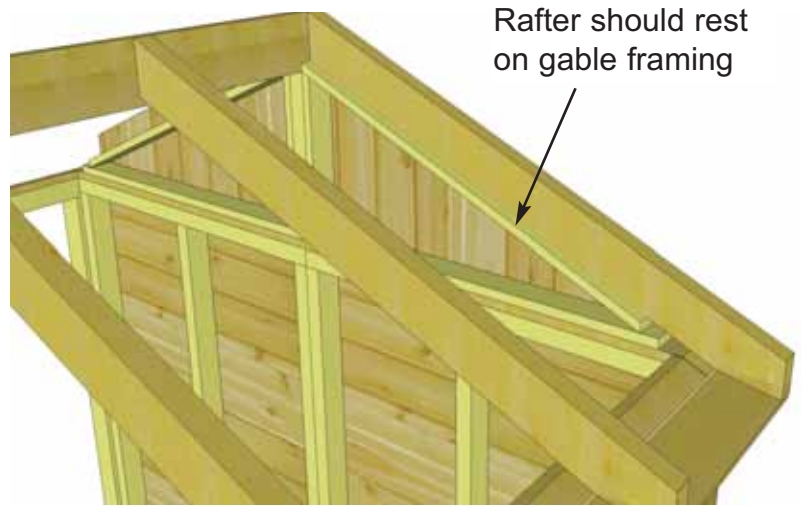

**37.** When Rafter Section is correctly positioned, outside rafters will sit equally on gable framing and Soffit will sit approximately 1/8" away from wall panels.

Completed rear side Rafters.

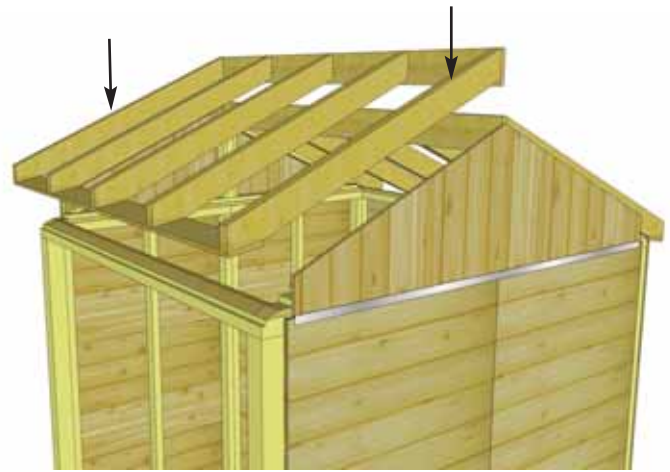
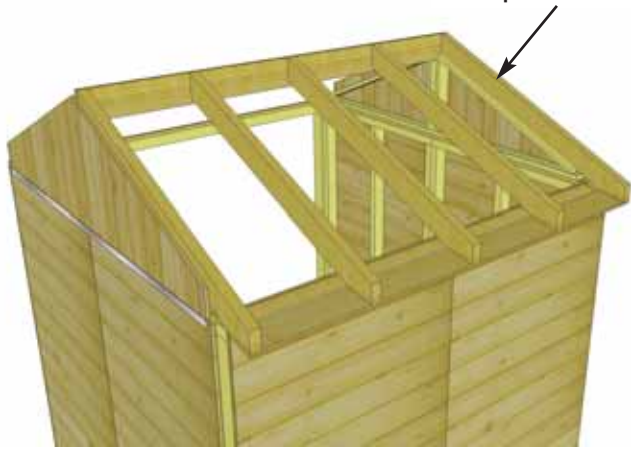

**38.** Place 2nd completed Rafter Section on gable wall framing. Position as per **Steps 34 - 36.**

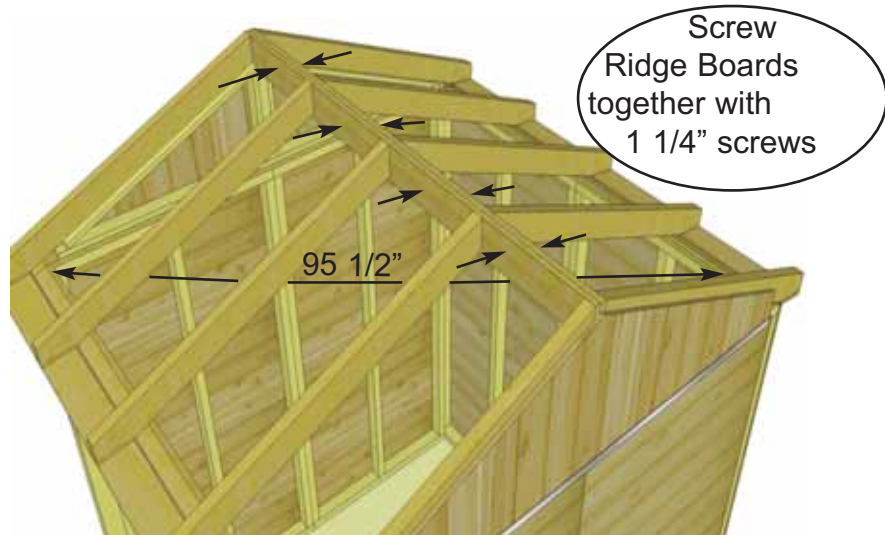
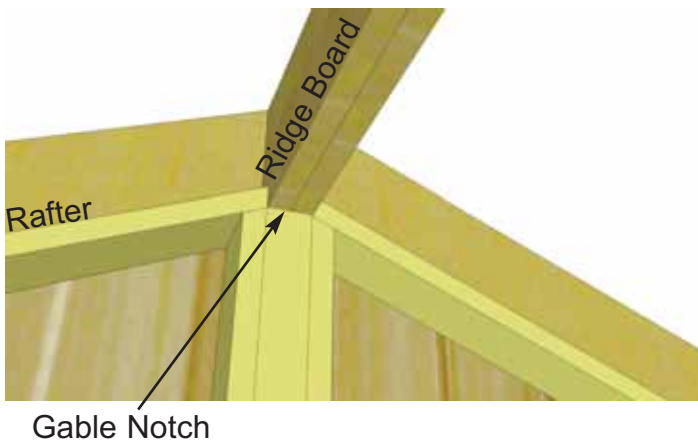

**39.** With Ridge Board locked into gable notch, align Ridge Boards so they are flush together and secure them with 8 - 1 1/4" screws. **Important-** if there is a gap between Ridge Boards, try pushing rear wall and Door Header closer together from outside. Before moving on with further steps, confirm your shed is square at wall height by checking the diagonal distance of the top walls on the inside. In both directions, the distance should be approximately **95 1/2"** depending on where you measure. It is important that both diagonal measurements are approximately equal. If not, adjust walls until an equal distance is achieved.

**40.** With both Ridge Boards connected, completely secure Gable framing to walls and rafters. Use 3 - 2" screws per Rafter. Use an additional 6 - 2" screws to secure Gable to wall.

**Note-** you may have to remove the 2 temporary screws in Gable from Step 29 and reposition Gable for best fit prior to completing gable attachment.





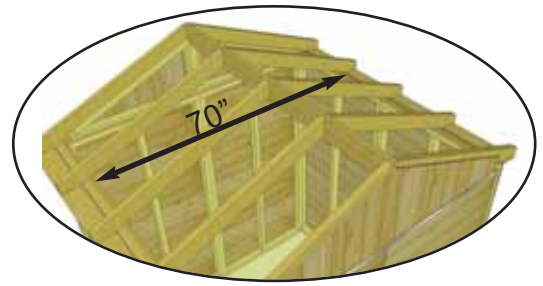
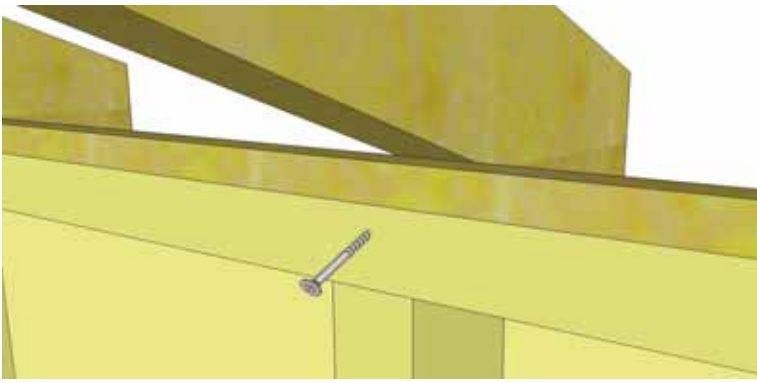

**41.** Secure Rafters to Top Wall Framing with one 3" screw per rafter. Screw through Wall Frame at an angle. Have two helpers push the Front and Rear Walls at the top from the outside of shed until inside to inside measurement between the Top Plates is 70".

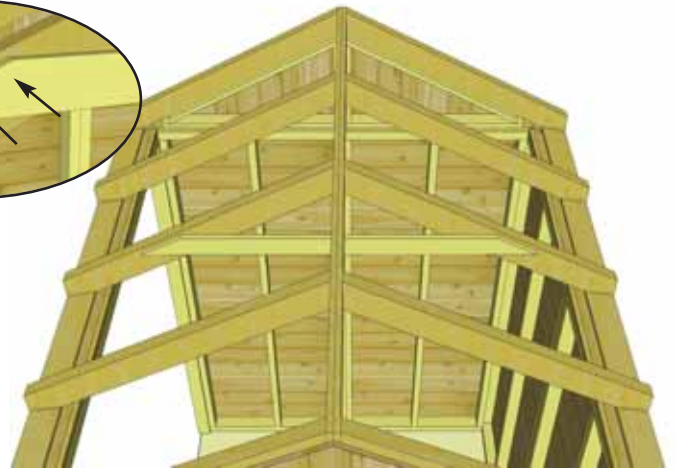

**42.** The **Roof Gusset** is positioned on center rafter. When correct, slide gusset up, use level to square gusset and attach to rafter with 4 - 1 1/4" screws. **Pilot hole Gusset to prevent splitting.**

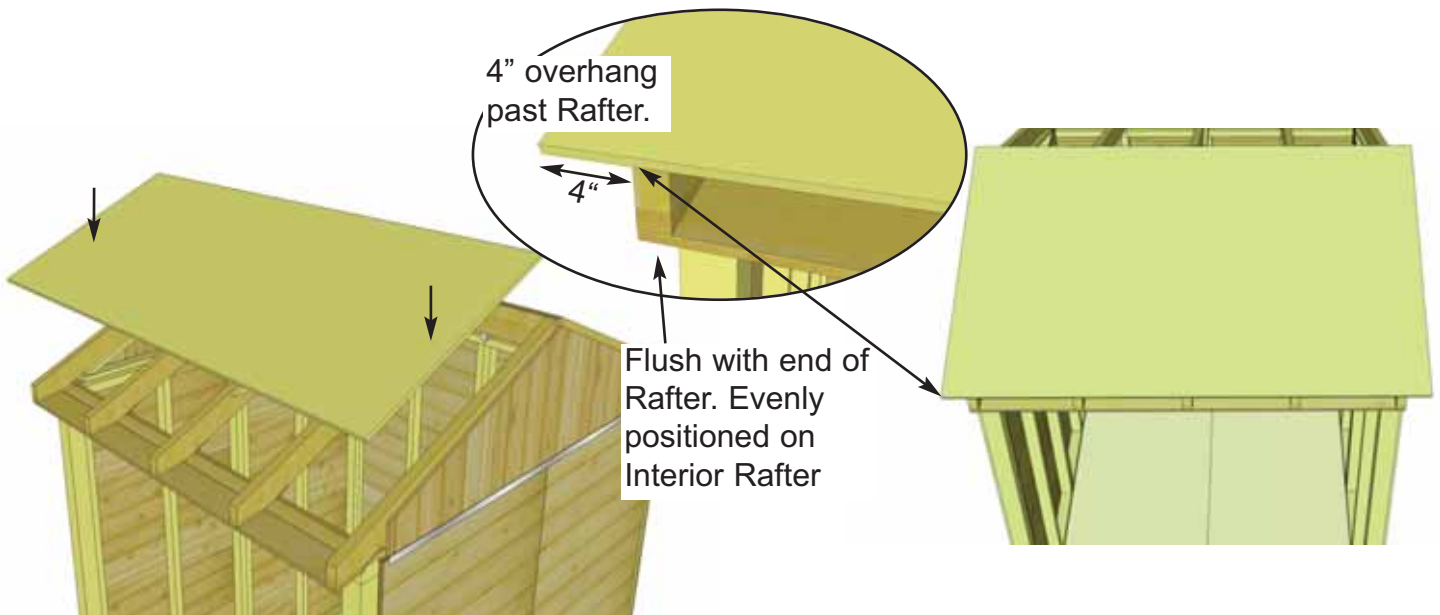

**43.** Starting in front corner, locate 5/8" x 78" x 45 1/4" Plywood Roof Section and place on top of Roof Rafters. Position so Plywood overhangs outside Rafter by 4". At bottom of Rafter, Roof Panel should be flush with Rafter end.



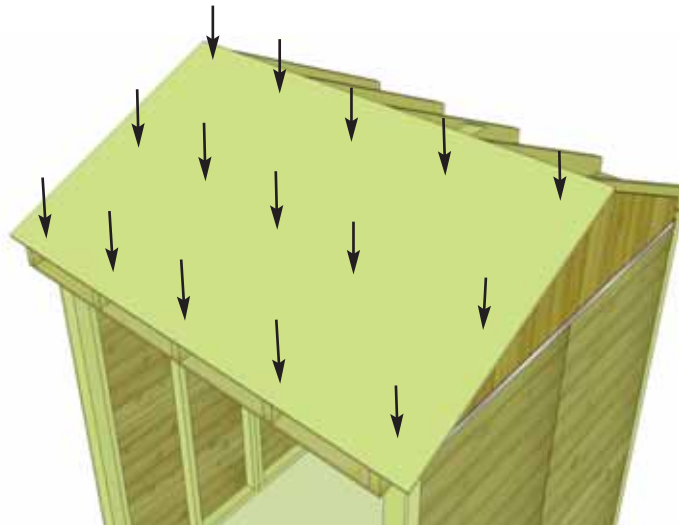
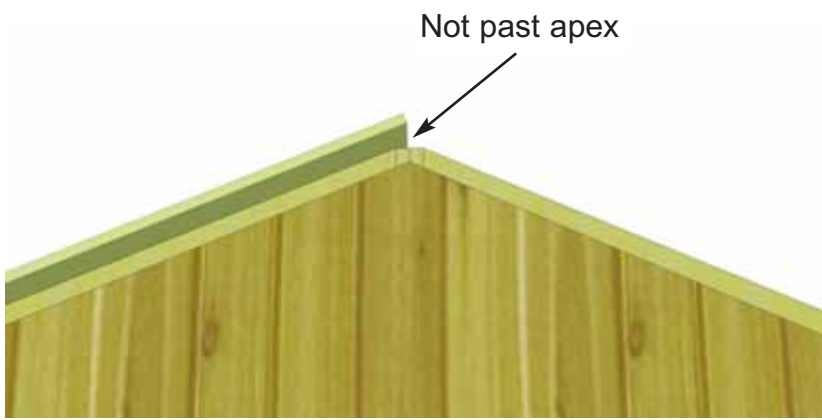

**44.** When Plywood is correctly positioned, fasten down into Roof Rafters with 15 - 1 1/4" screws.

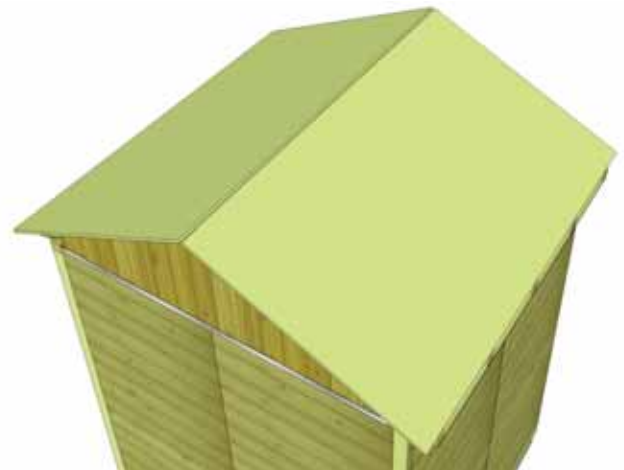

**45.** Locate Plywood Roof Piece for the rear side (78" x 45 1/4").



**46.** Position and attach as per **Steps 43- 45.**

# D. Miscellaneous Section

Exploded view of all parts necessary to complete the Miscellaneous Section. Identify all parts prior to starting.

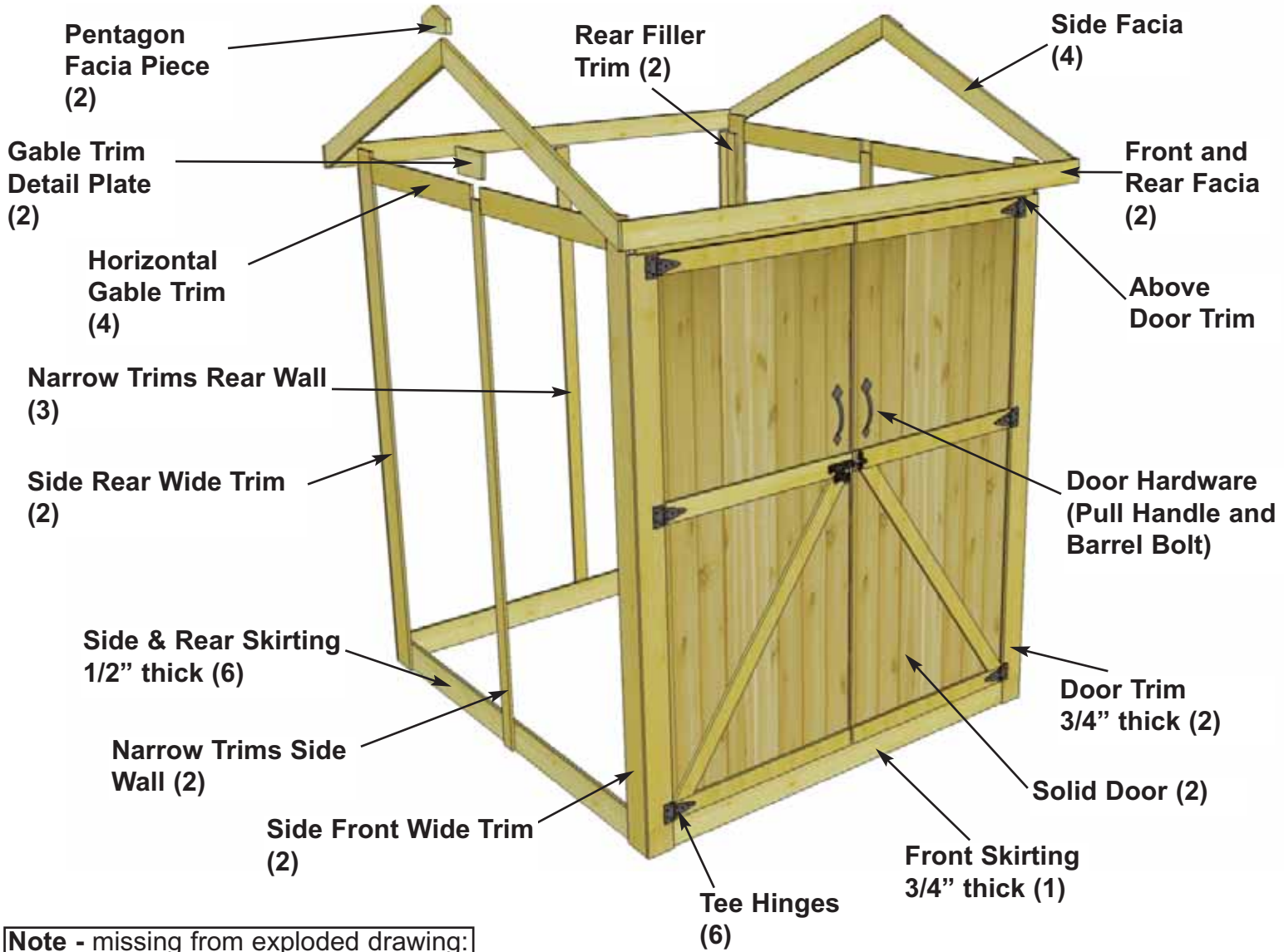

**Note** - missing from exploded drawing: Interior Cane Bolt, Horizontal and Vertical Door Stops, Door Threshold.

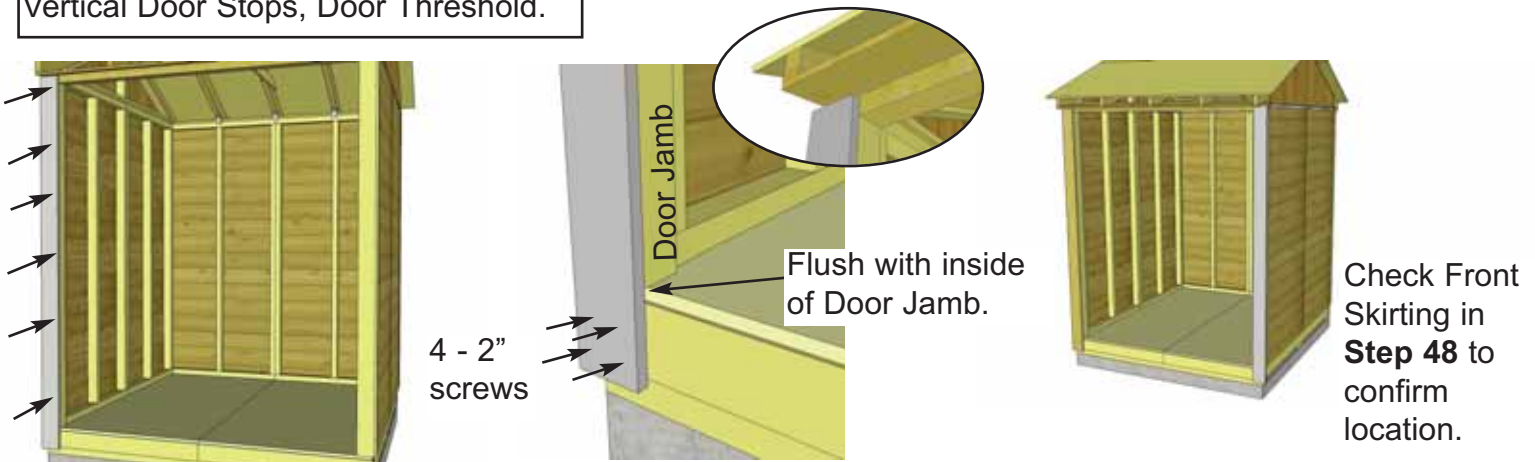

**47.** Locate both 3/4" x 4 3/8" x 79" Door Trims. Position a Trim so it covers the Door Jambs and is flush with the inside of it. Secure with 6 - 1 1/2" finishing nails. At the bottom, use 4 - 2" screws. Complete both Door Trims. **Important- Drill 1/8" pilot holes in bottom of Door Trims to prevent wood from splitting.**

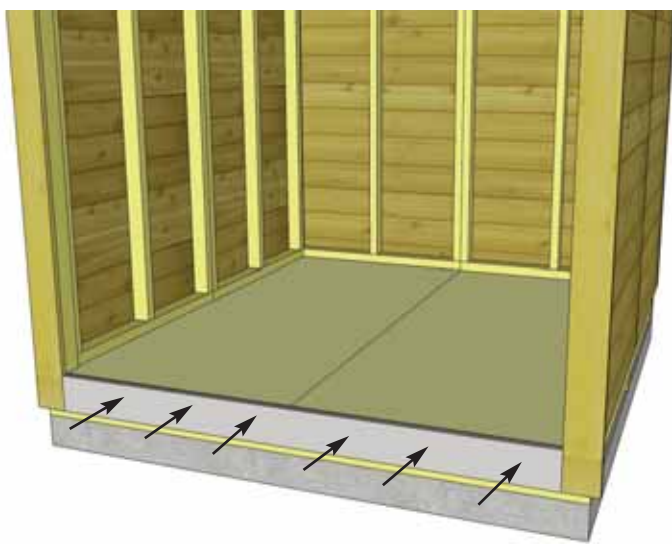

**48.** Position **Front Skirting** (3/4" thick) between Door Trims aligning it even at top edge with floor. Use 6 - 1 1/2" nails to secure.

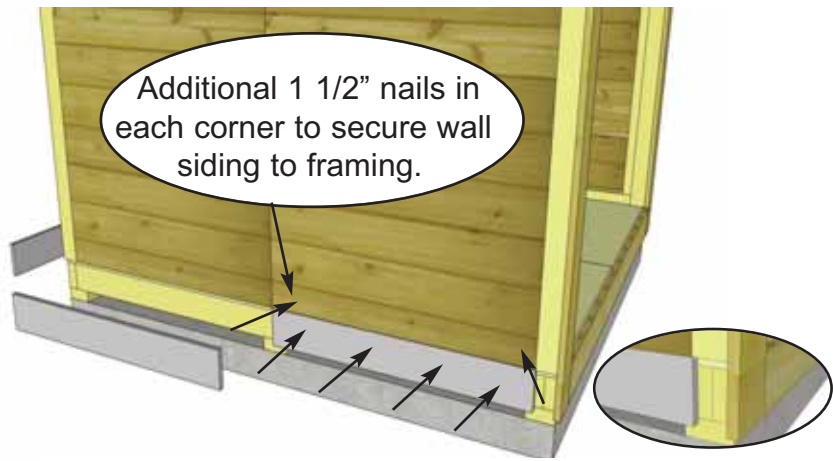

**49.** Attach **Side and Rear Skirting** around the base of the shed. Skirting will hide floor framing. The side skirting pieces will meet together in the center. Gaps on outside will be covered by Wide Trim pieces later. Use 4 - 1 1/2" nails to secure. Further secure bottom siding to wall framing in corners on each wall panel with 2 - 1 1/2" nails.

**50.** Attach **Rear Filler Trim** (7/8" x 2 1/2" x 75") to rear walls in each corner. Hammer with 6 - 1 1/2" finishing nails. Strips are positioned flush with siding and bottom Skirting.

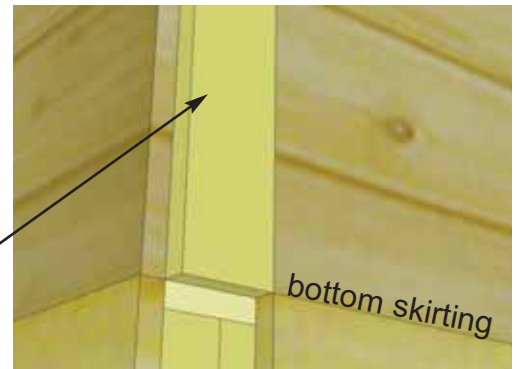

flush with wall siding

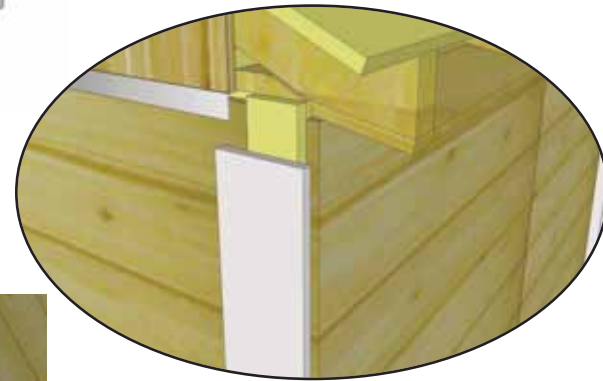
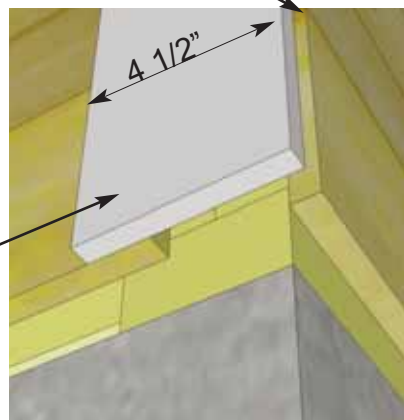

**51.** Attach **Side Rear Wide Trims** (1/2" x 4 1/2" x 77 1/2") over filler trim. Use 8 - 1 1/2" finishing nails per piece. Once again, edge of trim should be flush with wall siding. See **Step 52** for corner trim alignment.



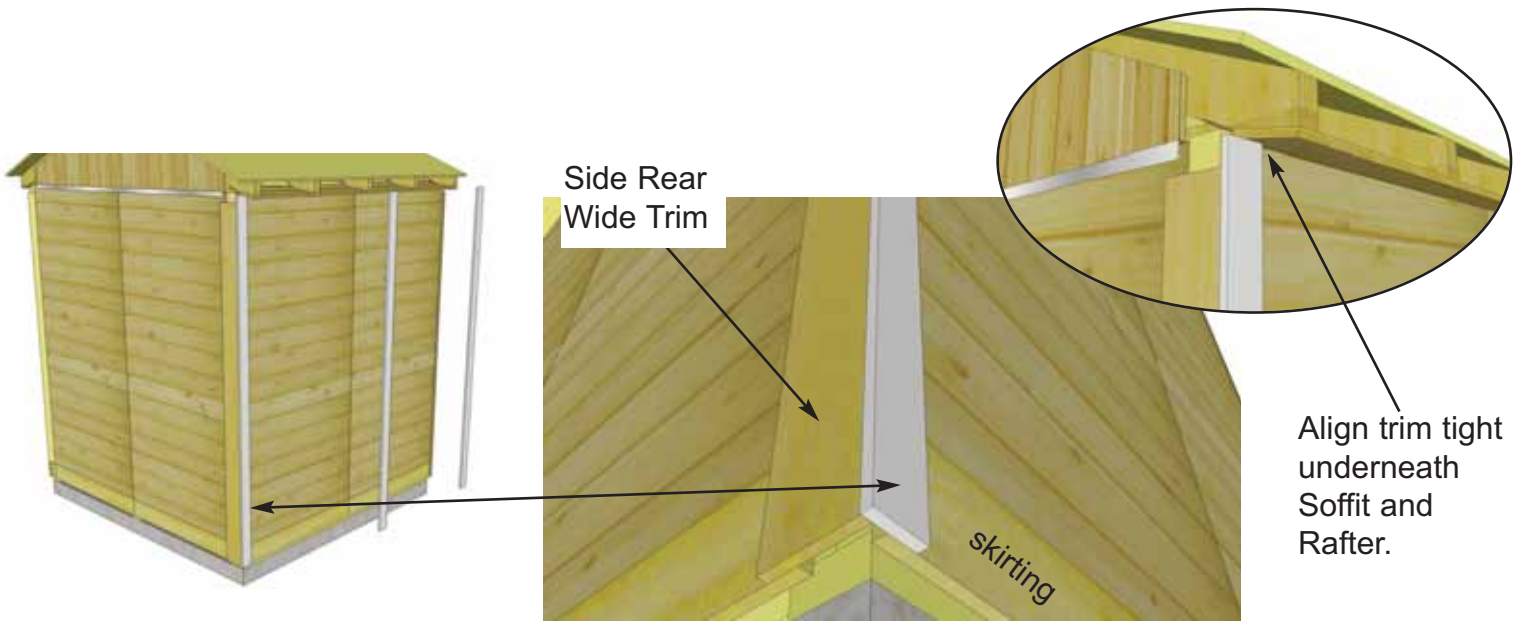

**52.** Attach **Narrow Trims (Rear Walls)** to in each rear corner and middle wall seam (3 - 1/2" x 2 1/2" x 79"). Use 8 - 1 1/2" finishing nails per piece. Align Trims tight underneath Soffit and Rafter and so it caps the Side Rear Wide Trim.



**53.** Position and attach **Side Front Wide Trims and Narrow Trims (Sides)**. Use 8 - 1 1/2" nails per piece to secure.



**54.** Attach **Horizontal Gable Trim** ( 4- 1/2" x 4 1/2" x 37 7/8") to both sides of shed. (2 per side). Position over gable and wall seam. Use 4 - 1 1/2" nails to secure each piece. Make sure gable trims covers flashing completely. Align even with outside of wide trim leaving a slight gap a center. Attach **Horizontal Detail Plates** over Gable Trim seam and secure with 4 - 1 1/2" nails. Complete both sides.

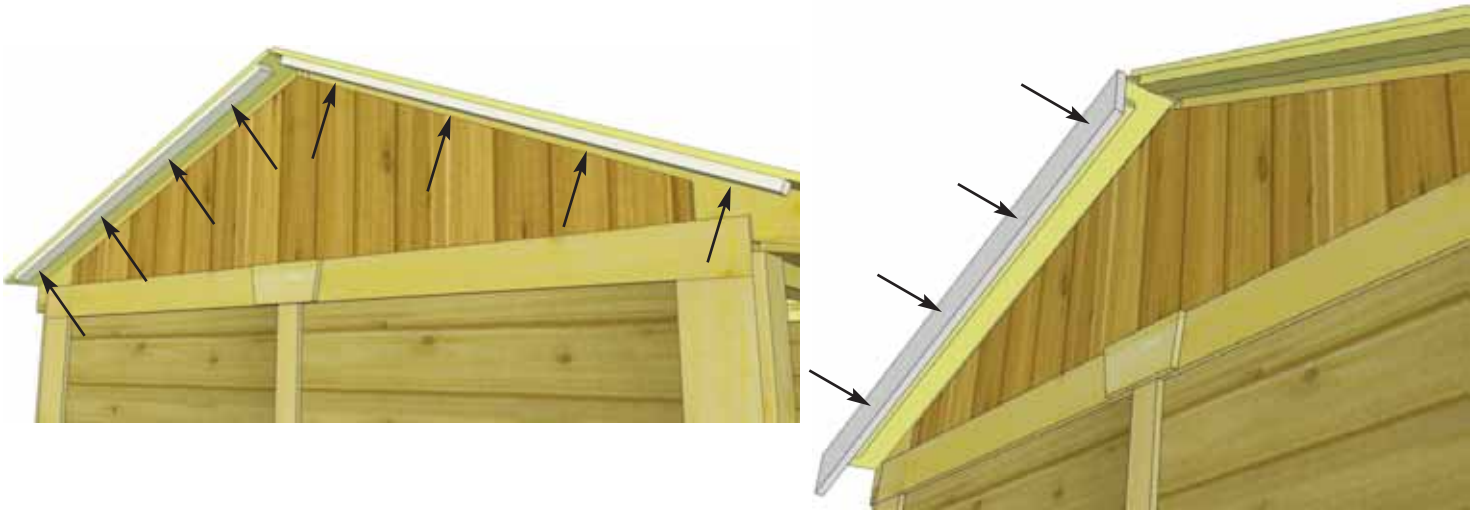

**55.** Attach **Facia Nailing Strips** (4 - 3/4" x 1 1/2" x 42") to underside edge of plywood roof with 4 - 1 1/4" screws per piece. Do this on both sides of the shed. Locate **Side Facia** (angle cut on both ends). There are 2 left and 2 right side pieces. Correct positioning is rough side out. Starting on one side, line facia up so the end is even with edge of plywood roof. Attach to nailing strip with 8 - 1 1/2" nails. Align 2nd Side Facia piece up with plywood edge. Note that there will be a slight gap where facias meet at the peak. This will be covered up with the Pentagon Facia Plate in Step in **Step 57**. Attach with 8 1 1/2" nails.

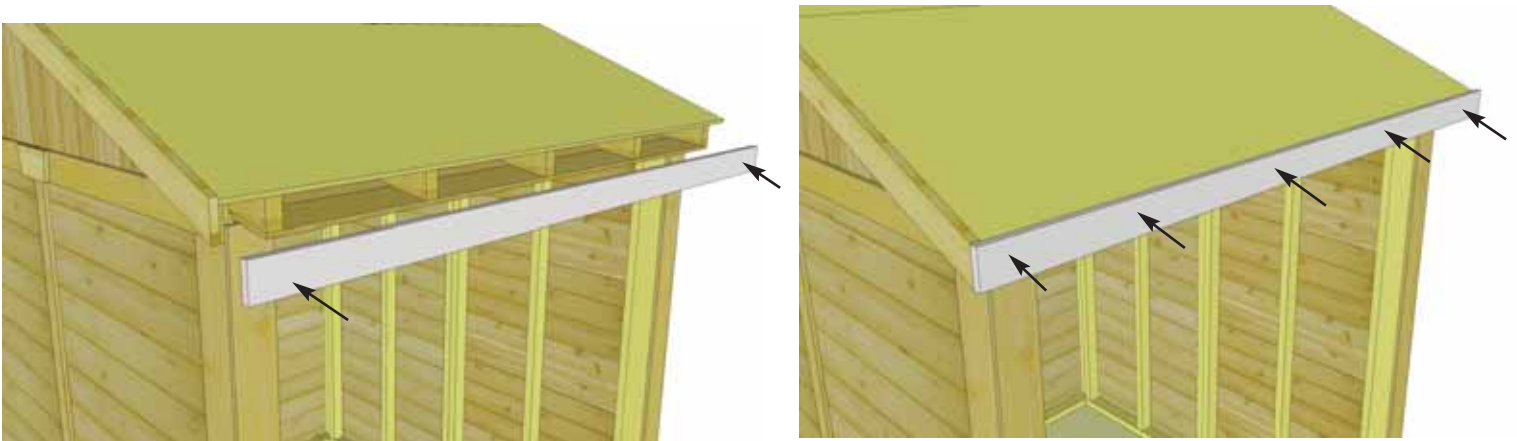
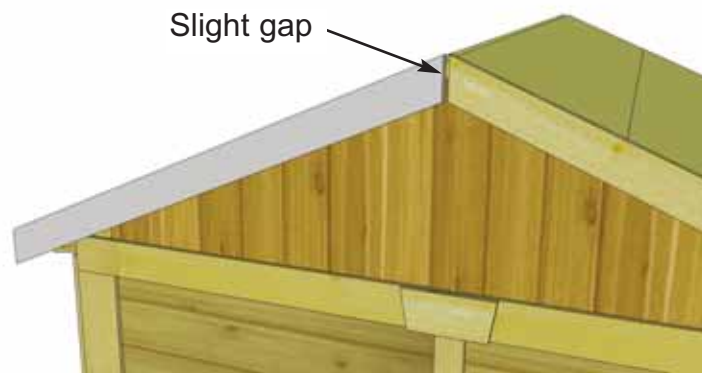

**56.** Position and attach **Front Facia** to ends of Roof Rafters with 10 - 1 1/2" nails. Front Facia will cap side facia in corners and line up on top edge with plywood roof.

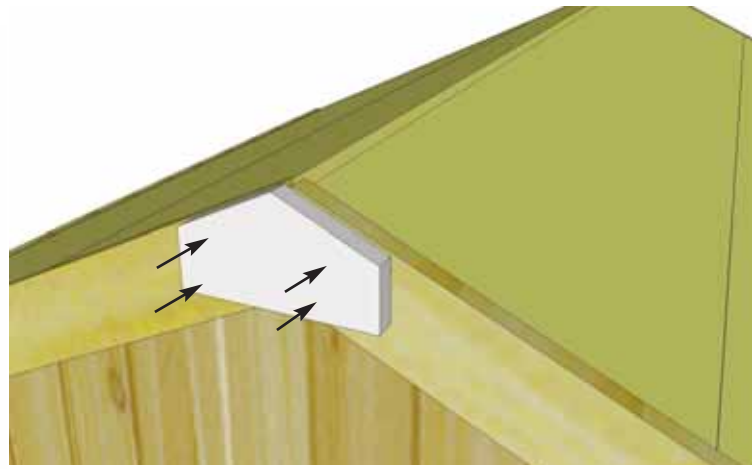

**57.** Complete remaining fascia pieces. Attach **Pentagon Facia Plate** where Side Facia meet at the peak. Use 4 - 1 1/2" finishing nails per piece to secure.



Attach Black Tee Hinges with 3/4" & 2" Black hardware provided

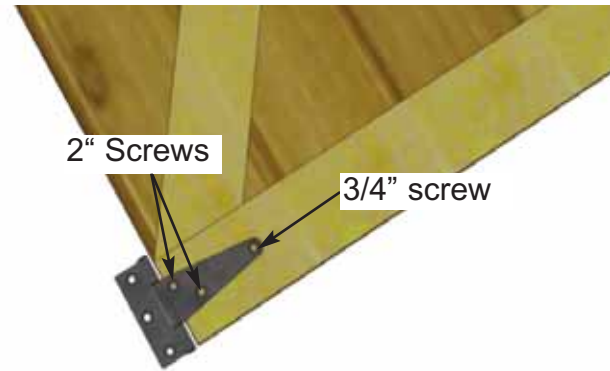

**Important-**  
Drill Pilot Holes  
to prevent  
splitting

**Note,** illustration of Hinge may not be accurate. The # of screw holes in the hinge may vary from three to four depending on model.

**58.** Attach Door Hinges to both **left** and **Right Side Double Doors**. Position Hinges equally on door trim as shown above and attach with Black 3/4" and 2" screws.



**59.** Next, position and secure the Double Doors. Starting with **Left Side Door**, position so there is a 1/2" gap on bottom and approximately 3/8" on the side. Use a spare Shingle to shim door in place at the bottom.



**Important-**  
Drill Pilot Holes  
to prevent  
splitting

3/8" on  
side.  
1/2" gap  
at bottom.

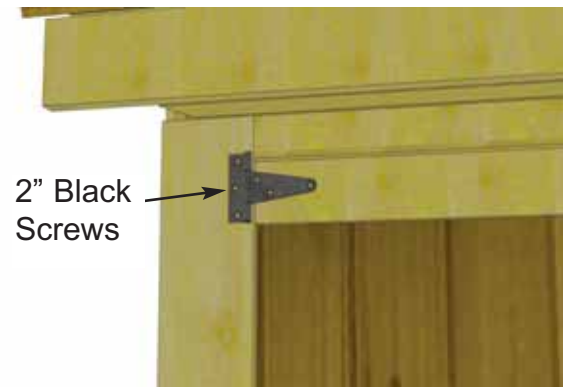
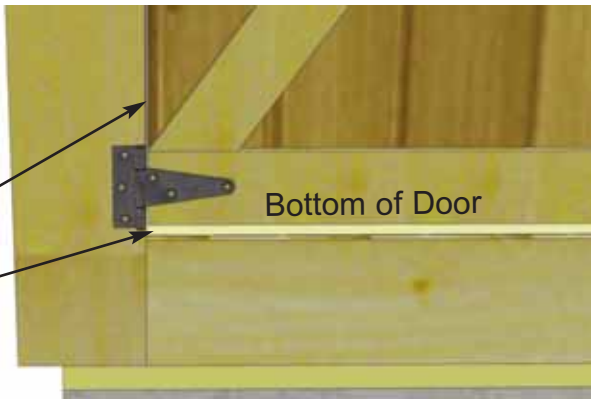

**60.** With Door correctly aligned, attach Door Hinge to Door Trim with 2" black screws. **Hint:** Do not attach all the 2" screws in each hinge until both doors are positioned correctly into place. Drill pilot holes in Door Trim prevent wood from splitting. When satisfied with door positioning, complete all 2" screws then.



**61.** Position and attach **Right Side Door** as per **Steps 59-60**. Door position may need slight adjusting to open and close correctly. When satisfied, complete all 2" screws. **Note,** Do not over tighten hinge screws when using screw gun.

Above Door Trim



**62.** Place **Above Door Trim** on door header between door trims. Attach with 6 - 1 1/2" nails. Leave small gap to allow for proper door opening and closing.

Hor. Door Stop with Dado cut.

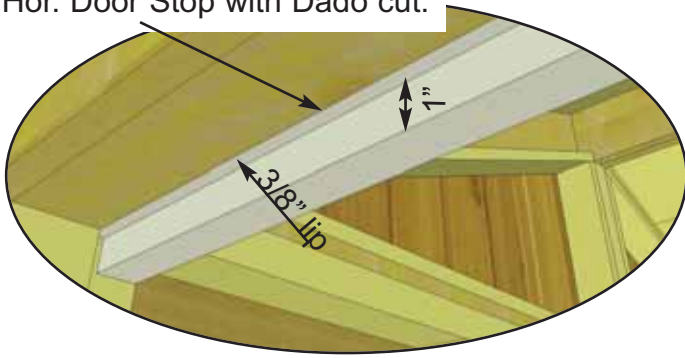

**63.** Position Horizontal Door Stop with dado facing out, tight against Door Header. Align so Dado cut is flush with Header leaving approximately a 1" overhang in the doorway. Attach with 6 - 2" screws.

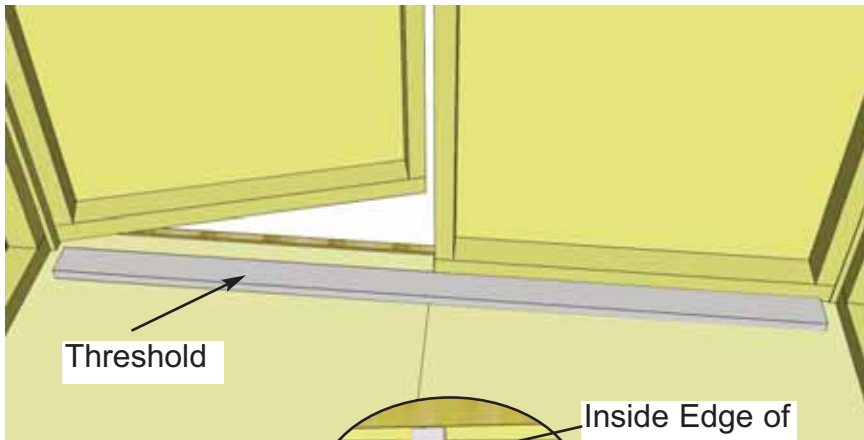
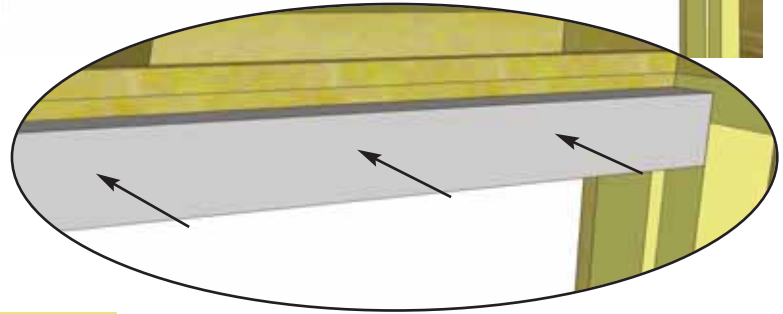
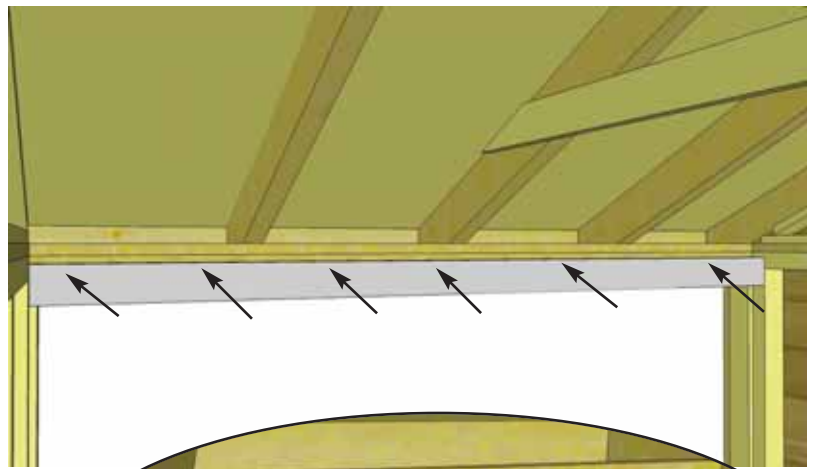

**64.** Close both doors and align so doors are straight. Attach Door Threshold (2 1/2" wide x 62 1/2" long) with 4 - 2" screws centering between doorway.

Door Flange

Inside Edge of Door Frame



**65.** Position and attach Door Flange and both Door Stops to door framing. Starting with the Door Flange Position and attach on inside door frame (**left door from outside**) using 6 - 2" screws. Position on inside edge of door frame so Flange overlaps door frame by 1". Position Door Stops in each corner screwing into door framing. Before attaching stop to door, check positioning to confirm Door Stop does not bind and adjust accordingly. Attach with 4 - 2" screws.

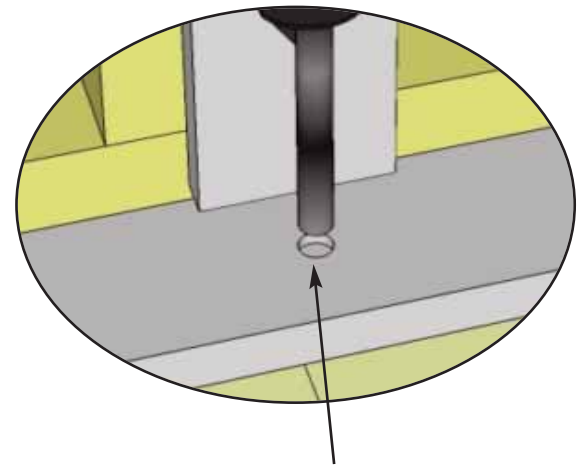
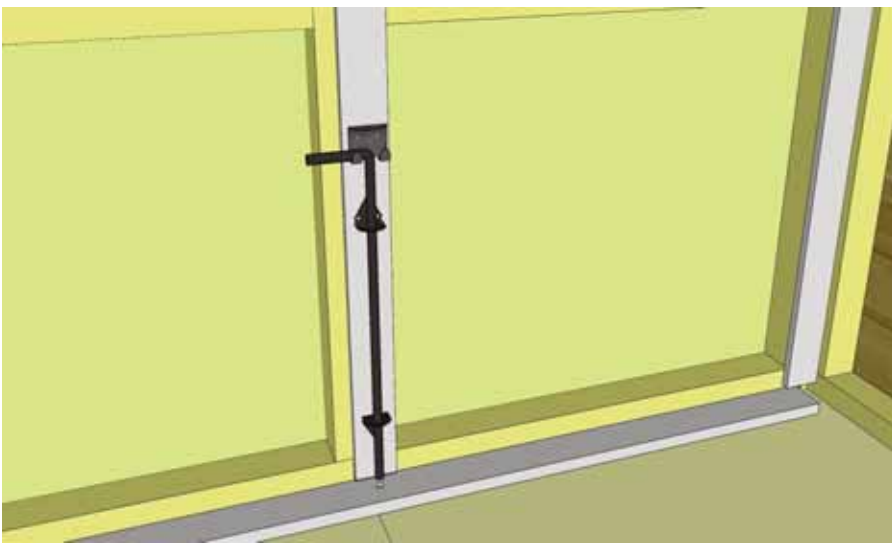

Drill 1/2" Diameter Hole to accommodate rod of Cane Bolt.

**66.** The **Interior Cane Bolt** will be attached to Vertical Door Flange. To position Cane Bolt correctly, attach to flange first, close doors and mark hole to house Cane Bolt Rod. Open doors and drill hole where previously marked with 1/2" bit. Attach with 3/4" Black Screws.

**Important** - Drill pilot holes with 1/8" drill bit prior to securing with screws to prevent wood splitting. On 3/4" screw, drill shallow pilot hole only.

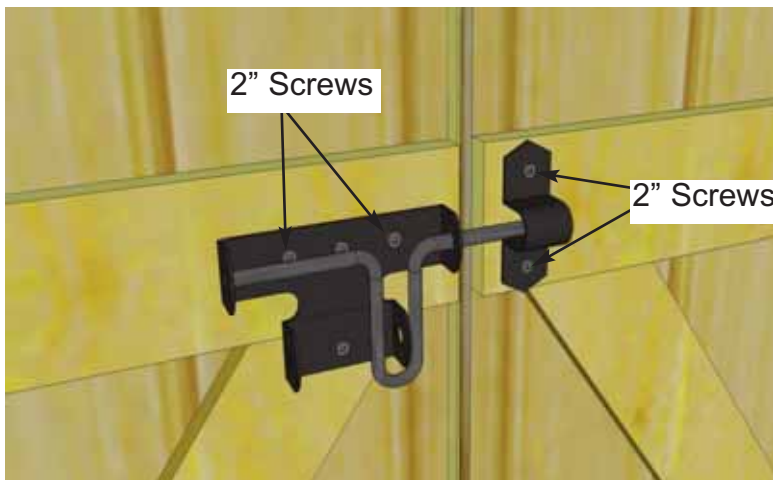

**67.** Attach Black Barrel Bolt as illustrated above with 2" & 3/4" Black Screws. Note how female part of Barrel Bolt is positioned higher than male. Do a dry run first to position Barrel Bolt correctly. **Important** - Drill a shallow pilot hole with 1/8" drill bit prior to securing with screws to prevent wood splitting.



**68.** Attach **Door Handles**. Handles are positioned on top section of each door and mounted with 3/4" Black Screws.





## Congratulations on assembling your 6x6 Maximizer Storage Shed!

**Note;** Our Sheds are shipped as an unfinished product. If exposed to the elements, the western red cedar lumber will weather to a silvery-gray color. If you prefer to keep the cedar lumber looking closer to the original color, we suggest that you treat the wood with a good oil base wood stain. You may also wish to paint your new shed rather than stain it. In both cases we recommend that you consult with a paint and stain dealer in your area for their recommendations.



We hope your experience assembling your 6x6 Maximizer Storage Shed has been both positive and rewarding.

We value your feedback and would like to hear back from you on how well we are doing in the following areas:

1. Customer Service
2. On Time Shipping
3. Motor Freight Delivery
4. Quality of Materials
5. Assembly Manual
6. Overall Satisfaction.

Please call, write or email us at:

Outdoor Living Today

Canadian Address  
9393 287th Street  
Maple Ridge, British Columbia  
Canada V2W 1L1

United States Address  
P.O. Box 96  
Sumas, Washington  
USA 98295



The materials contained in this Assembly Manual may be downloaded or copied provided that ALL copies retain the copyright and any other proprietary notices contained on the materials. No material may be modified, edited or taken out of context such that its use creates a false or misleading statement or impression as to the positions, statements or actions.