

Installing and Testing an Isolated Ground GFCI Receptacle

Please read this leaflet completely before getting started.

PK-A3083-10-00-2A

CAUTION

- To prevent severe shock or electrocution always turn the power OFF at the service panel before working with wiring.
- Use this GFCI with copper or copper-clad wire. Do not use it with aluminum wire.
- Do not install this GFCI receptacle on a circuit that powers life support equipment because if the GFCI trips it will shut down the equipment.
- For installation in wet locations, protect the GFCI receptacle with a weatherproof cover that will keep both the receptacle and any plugs dry.
- Must be installed in accordance with national and local electrical codes.

1. What is a GFCI?

A GFCI receptacle is different from conventional receptacles. In the event of a ground fault, a GFCI will trip and quickly stop the flow of electricity to prevent serious injury.

Definition of a ground fault:

Instead of following its normal safe path, electricity passes through a person's body to reach the ground. For example, a defective appliance can cause a ground fault.

A GFCI receptacle does **NOT** protect against circuit overloads, short circuits, or shocks. For example, you can still be shocked if you touch bare wires while standing on a non-conducting surface, such as a wood floor.

NOTE:

- GFCI's contain a lockout feature that will prevent RESET if:
- There is no power being supplied to the GFCI.
 - The GFCI is miswired due to reversal of the LINE and LOAD leads.
 - The GFCI cannot pass its internal test, indicating that it may not be able to provide protection in the event of a ground fault.

2. The GFCI's features

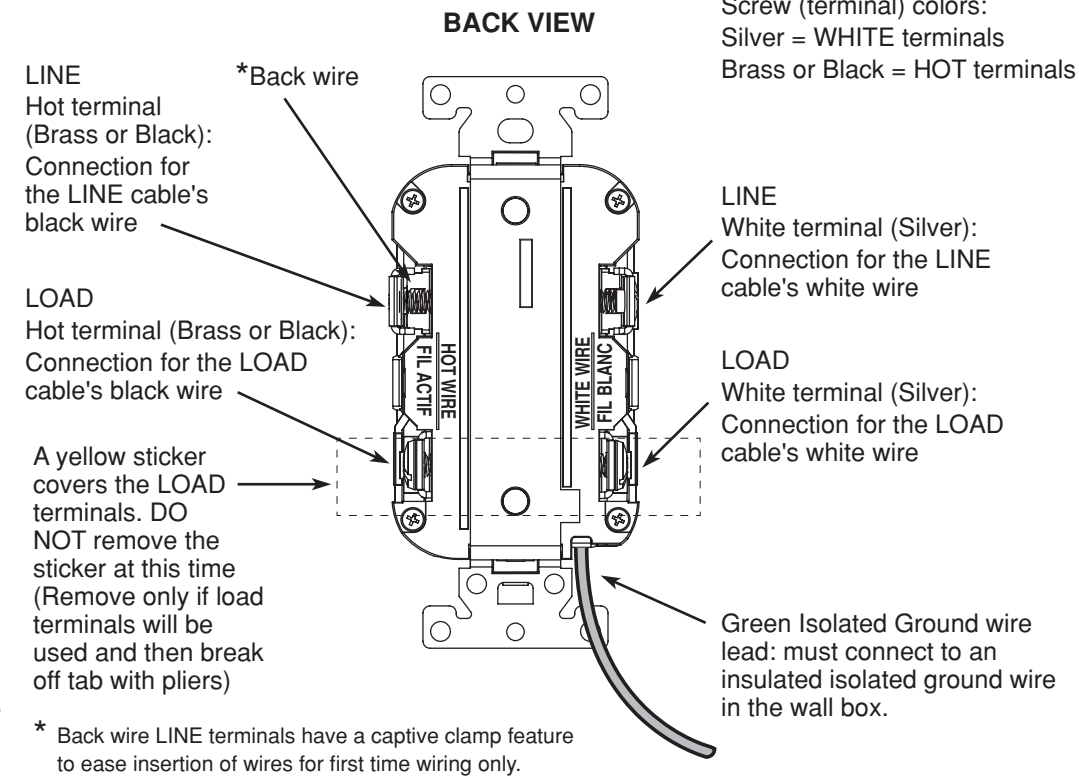
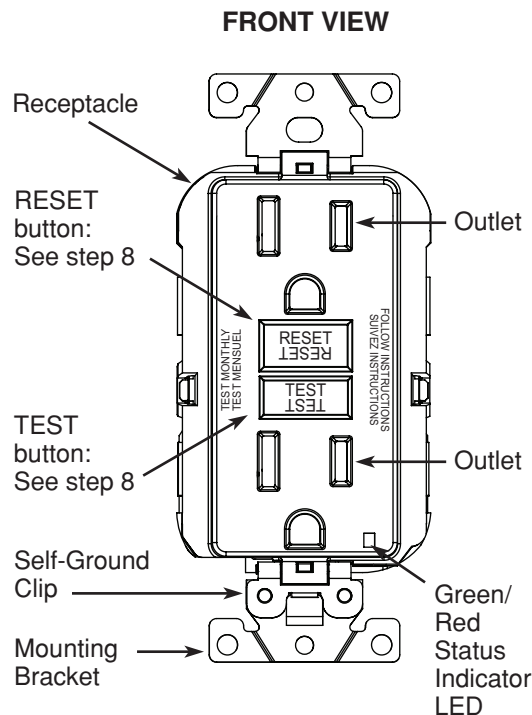

3. Should you install it?

Installing a GFCI receptacle can be more complicated than installing a conventional receptacle.

Make sure that you:

- Understand basic wiring principles and techniques
- Can interpret wiring diagrams
- Have circuit wiring experience
- Are prepared to take a few minutes to test your work, making sure that you have wired the GFCI receptacle correctly

4. LINE vs. LOAD

A cable consists of 2 or 3 wires.

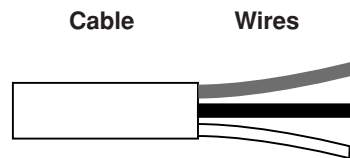

LINE cable:

Delivers power from the service panel (breaker panel or fuse box) to the GFCI. If there is only one cable entering the electrical box, it is the LINE cable. This cable should be connected to the GFCI's LINE terminals only.

LOAD cable:

Delivers power from the GFCI to another receptacle in the circuit. This cable should be connected to the GFCI's LOAD terminals only. The LOAD terminals are under the yellow sticker. **DO NOT** remove the sticker at this time.

5. Turn the power OFF

Plug an electrical device, such as a lamp or radio, into the receptacle on which you are working. Turn the lamp or radio ON. Then, go to the service panel. Find the breaker or fuse that protects that receptacle. Place the breaker in the OFF position or completely remove the fuse. The lamp or radio must turn OFF.

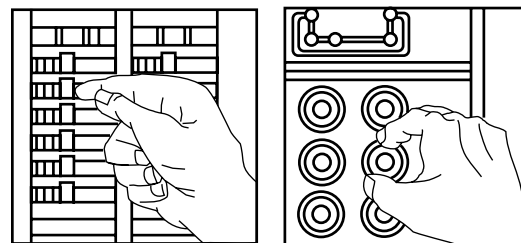

Next, plug in and turn ON the lamp or radio at the receptacle's other outlet to make sure the power is OFF at both outlets. If the power is not OFF, stop work and call an electrician to complete the installation.

6. Identify cables/wires

Important:

DO NOT install the GFCI receptacle in an electrical box containing (a) more than four (4) wires (not including the bare copper and green insulated grounding wires) or (b) cables with more than two (2) wires (not including the bare copper and green insulated grounding wires). Contact a qualified electrician if either (a) or (b) are true.

If you are replacing an old receptacle, pull it out of the electrical box without disconnecting the wires.

- If you see one cable (2-wires plus a bare copper or green insulated ground), it is the LINE cable. The receptacle is probably in position C (see diagram to the right). Remove the receptacle and go to step 7A.
- If you see two cables (4 wires plus a bare copper or green insulated ground), the receptacle is probably in position A or B (see diagram to the right). Follow steps a-e of the procedure to the right.

Procedure: box with two (2) cables (4 wires plus a bare copper or green insulated ground):

- Detach one cable's white wire and hot wires from the receptacle and cap each one separately with a wire connector. Make sure that they are from the same cable.
- Re-install the receptacle in the electrical box, attach faceplate, then turn the power ON at the service panel.
- Determine if power is flowing to the receptacle. If so, the capped wires are the LOAD wires. If not, the capped wires are the LINE wires.
- Turn the power OFF at the service panel, label the LINE and LOAD wires, then remove the receptacle.
- Go to step 7B.

Placement in circuit:

The GFCI's place in the circuit determines if it protects other receptacles in the circuit.

Sample circuit:

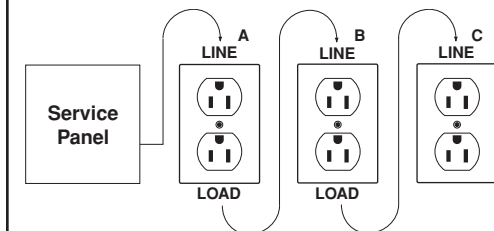

Placing the GFCI in position A will also provide protection to "load side" receptacles B and C. On the other hand, placing the GFCI in position C will not provide protection to receptacles A or B. Remember that receptacles A, B, and C can be in different rooms.

7. Connect the wires (choose A or B)... only after reading other side completely

A: One Cable (2 or 3 wires) entering the box

OR

B: Two cables (4 or 6 wires) entering the box

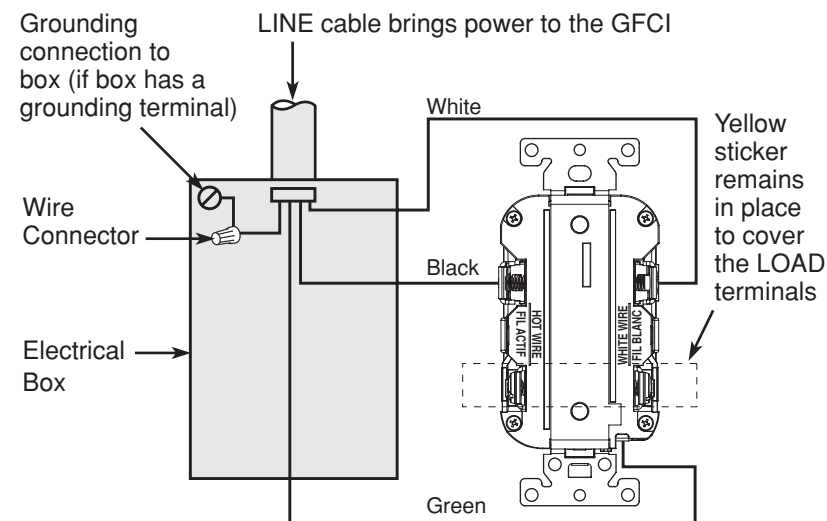

About Wire Connections: Side Wire:



For Side wire - Loop clockwise 2/3 of the way around screw

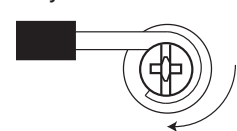

Back Wire:

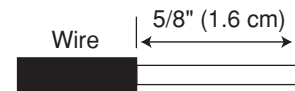

For Back wire - Insert bare wire fully and tighten terminal clamp on conductor ONLY

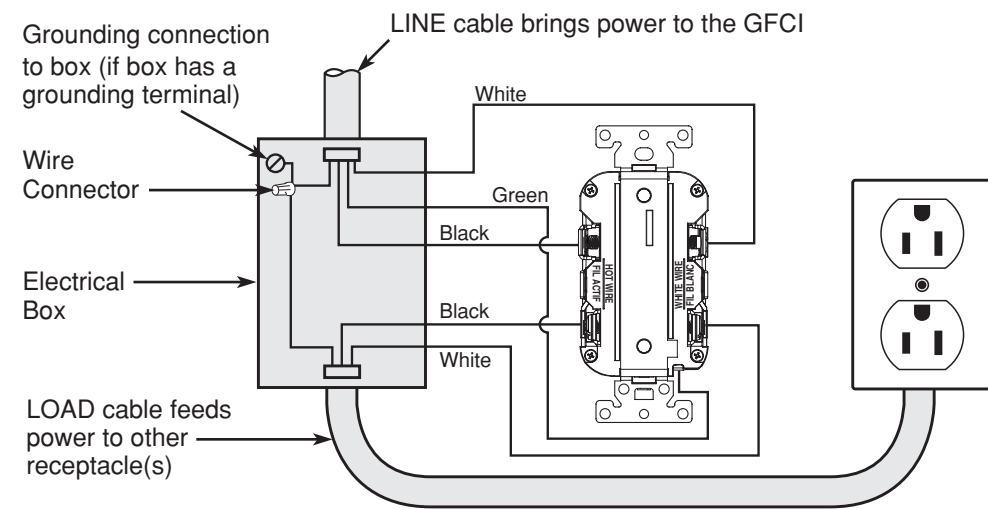
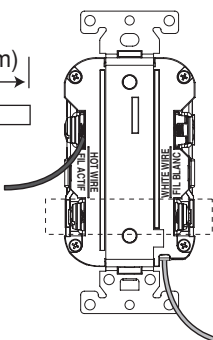

About Wire Connections: Side Wire:



For Side wire - Loop clockwise 2/3 of the way around screw

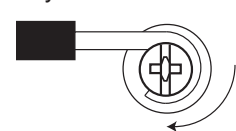

Back Wire:

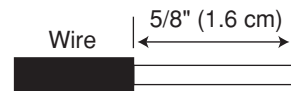

For Back wire - Insert bare wire fully and tighten terminal clamp on conductor ONLY

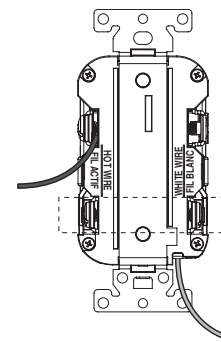

Connect the LINE cable wires to the LINE terminals:

- The white wire connects to the WHITE terminal (Silver)
- The black wire connects to the HOT terminal (Brass or Black)

Connect the grounding wire(s):

- Isolated Ground Receptacles must be mounted in a grounded metal wallbox.
- Connect bare copper ground wire (if present) to the metal wallbox. Connect the GREEN wire lead of the GFCI to the insulated Isolated Ground wire in the wallbox.

Complete the installation:

- Fold the wires into the box, keeping the grounding wire away from the WHITE and HOT terminals. Screw the receptacle to the box and attach the faceplate.
- Go to step 8.

Connect the LINE cable wires to the LINE terminals:

- The white wire connects to the WHITE terminal (Silver)
- The black wire connects to the HOT terminal (Brass or Black)

Connect the LOAD cable wires to the LOAD terminals:

- Remove the YELLOW sticker to reveal the LOAD terminals
- The white wire connects to the WHITE terminal (Silver)
- The black wire connects to the HOT terminal (Brass or Black)

Connect the grounding wire(s):

- Isolated Ground Receptacles must be mounted in a grounded metal wallbox.
- Connect bare copper ground wire (if present) to the metal wallbox. Connect the GREEN wire lead of the GFCI to the insulated Isolated Ground wire in the wallbox.

Complete the installation:

- Fold the wires into the box, keeping the grounding wire away from the WHITE and HOT terminals. Screw the receptacle to the box and attach the faceplate.
- Go to step 8.

NOTE: LINE and LOAD wiring terminals accept #10 - #14 AWG solid or stranded copper wire.

8. Test your work

Why perform this test?

- If you miswired the GFCI it may not prevent personal injury or death due to a ground fault (electrical shock).
- If you mistakenly connect the LINE wires to the LOAD terminals, the GFCI will not reset and will not provide power to either the GFCI receptacle face or any receptacles fed from the GFCI.

Procedure:

- This GFCI is shipped from the factory in the tripped condition and cannot be reset until it is wired correctly and power is supplied to the device. Plug a lamp or radio into the GFCI (and leave it plugged in). Turn the power ON at the service panel. Ensure that the GFCI is still in the tripped condition by pressing the TEST button. If the lamp or radio is OFF, and the GFCI will not reset, go to the Troubleshooting section as the Line and Load connections are reversed.
- Press the RESET button **fully** and release. If the Status Indicator Light turns Green and the lamp or radio is ON, the GFCI has been installed correctly. If the Status Indicator Light turns or continuously blinks Red, or the GFCI cannot be reset, go to the Self-Test Operation section.
- If you installed your GFCI using step 7B, plug a lamp or radio into surrounding receptacles to see which one(s), in addition to the GFCI, lose power when you press the GFCI TEST button. Place a "GFCI PROTECTED OUTLET" sticker on every receptacle that lost power, then press the RESET button to reset the GFCI. **DO NOT** plug life saving devices into any of the receptacles that lost power.
- Press the TEST button (then RESET button) **every month** to assure proper operation. If the Status Indicator Light does not turn Green when the RESET button is depressed and then released, or the GFCI cannot be reset, it must be replaced.

TROUBLESHOOTING

Turn the power OFF and check the wire connections against the appropriate wiring diagram in step 7A or 7B. Make sure that there are no loose wires or loose connections. If the Status Indicator Light is not ON and the device is unable to reset this could be a result of no power available. Start the test from the beginning of step 8 if you rewired any connections to the GFCI.

SELF-TEST OPERATION

- A Self-Test GFCI receptacle has all the features of a conventional GFCI receptacle. In addition, this receptacle tests itself periodically to confirm the GFCI electronics are functional. The Status Indicator Light will be solid green when the GFCI is powered from Line side and working correctly.
- Self-Test Indications:** If the Status Indicator Light is solid or flashing RED a problem may exist. Press the TEST button to trip the GFCI. If unable to Reset, replace the GFCI. **NOTE:** The status indicator may flash Red at power "ON" and Reset.

Self Test Cat. No.	Description
GFTR1-IGx	15A-125VAC, 60Hz Tamper Resistant Isolated Ground GFCI
GFTR2-IGx	20A-125VAC, 60Hz Tamper Resistant Isolated Ground GFCI

All devices rated 20A feed-through

SmartLockPro is a Trademark of Leviton Manufacturing Co., Inc. registered in the United States, Canada, Mexico and China.

LIMITED 2 YEAR WARRANTY AND EXCLUSIONS

Leviton warrants to the original consumer purchaser and not for the benefit of anyone else that this product at the time of its sale by Leviton is free of defects in materials and workmanship under normal and proper use for two years from the purchase date. Leviton's only obligation is to correct such defects by repair or replacement, at its option. **For details visit www.leviton.com or call 1-800-824-3005.** This warranty excludes and there is disclaimed liability for labor for removal of this product or reinstallation. This warranty is void if this product is installed improperly or in an improper environment, overloaded, misused, opened, abused, or altered in any manner, or is not used under normal operating conditions or not in accordance with any labels or instructions. **There are no other or implied warranties of any kind, including merchantability and fitness for a particular purpose, but if any implied warranty is required by the applicable jurisdiction, the duration of any such implied warranty, including merchantability and fitness for a particular purpose, is limited to two years. Leviton is not liable for incidental, indirect, special, or consequential damages, including without limitation, damage to, or loss of use of, any equipment, lost sales or profits or delay or failure to perform this warranty obligation.** The remedies provided herein are the exclusive remedies under this warranty, whether based on contract, tort or otherwise.

For Technical Assistance Call: 1-800-824-3005 (U.S.A. Only) 1 800 405-5320 (Canada Only) www.leviton.com

FCC STATEMENT

This equipment has been tested and found to comply with the limits for a Class B digital device, pursuant to part 15 of the FCC Rules. These limits are designed to provide reasonable protection against harmful interference in a residential installation. This equipment generates, uses and can radiate radio frequency energy and, if not installed and used in accordance with the instructions, may cause harmful interference to radio communications. However, there is no guarantee that interference will not occur in a particular installation. If this equipment does cause harmful interference to radio or television reception, which can be determined by turning the equipment off and on, the user is encouraged to try to correct the interference by one or more of the following measures:

- Reorient or relocate the receiving antenna.
- Increase the separation between the equipment and receiver.
- Connect the equipment into an outlet on a circuit different from that to which the receiver is connected.
- Consult the dealer or an experienced radio/TV technician for help.

IC STATEMENT

This device complies with Industry Canada licence-exempt RSS standard(s). Operation is subject to the following two conditions: (1) this device may not cause interference, and (2) this device must accept any interference, including interference that may cause undesired operation of the device.

This product is covered by U.S. Patent Nos. 6,040,967; 6,246,558; 6,282,070; 6,381,112; 6,437,953; 6,646,838; 6,657,834; 6,788,173; 6,864,766; 6,944,001; 7,336,458; 7,355,117; 7,400,479; 7,463,124; 7,697,252; 7,737,809; 7,764,151; 7,820,909; 7,868,719; 7,907,371; 8,004,804; 8,054,595; 8,130,480; 8,242,362; 8,547,126; 8,587,914; 8,599,522; and corresponding foreign patents.

FOR CANADA ONLY

For warranty information and/or product returns, residents of Canada should contact Leviton in writing at **Leviton Manufacturing of Canada Ltd to the attention of the Quality Assurance Department, 165 Hymus Blvd, Pointe-Claire (Quebec), Canada H9R 1E9** or by telephone at 1 800 405-5320.