

# OWNER'S GUIDE

## ENERGY SAVER CLASSIC LINE

MODELS: ES-1500, ES-2250, ES-3100, ES-4700, ES-5400



MODELS: ES-6400



**DO NOT THROW AWAY! SERIAL NUMBER FOR FAN IS LOCATED ON BACK COVER OF OWNER'S GUIDE. RETAIN IN A SAFE PLACE.**

SEE // HEAR // FEEL  
THE QUIETCOOL DIFFERENCE

## GENERAL SAFETY INSTRUCTIONS

- 1. Read Instructions** - All safety and operation instructions must be read.
- 2. Retain Instructions** - The safety and operating instructions should be kept for future reference.
- 3. Heed Warnings** - All warnings should be followed.
- 4. Follow Instructions** - All installation and operating instructions should be followed.
- 5. Water** - The QuietCool system should not be used near water. If you live in a very humid climate, be sure to cover your damper box with insulation to reduce condensation.
- 6. Heat** - The QuietCool system should be situated away from heat sources.
- 7. Damage Requiring Service** - Only qualified service personnel should service the QuietCool system. The user should not attempt to service the product.

## CONTENTS

1. QUICKSTART GUIDE .....	3
1-1 Special Instructions .....	3
1-2 Product Diagram.....	4
1-3 When to Run Fans.....	5
1-4 Where to Start Cooling.....	5
1-5 Indoor Air Quality.....	5
2. SYSTEM OVERVIEW .....	6
2-1 Introduction.....	6
2-2 Features .....	6
2-3 System Venting Recommendations.....	7
3. INSTALLATION .....	8
3-1 Installing QuietCool.....	8
3-2 Installing Vertical Adapter .....	12
4. WIRING .....	13
4-1 Single Speed Wiring.....	14
4-2 Two Speed Wiring.....	15
4-3 Two Motorhead Wiring .....	18
ENERGY SAVER CLASSIC WARRANTY.....	23
SERIAL NUMBER.....	BACK COVER



**QC Manufacturing, Inc.**  
43352 Business Park Drive  
Temecula, CA 92590

PH 951.325.6340  
FX 951.325.6351

[QuietCoolSystems.com](http://QuietCoolSystems.com)

## INCLUDED IN THE BOX

- QuietCool Whole House Fan
- QuietCool Damper Box
- QuietCool Duct
- Ceiling Grille
- Window locks (2)
- Accessory Bag containing needed hardware
- Cut-out Template
- Controls (if applicable)

## READ ALL INSTRUCTIONS IN THIS GUIDE BEFORE INSTALLING YOUR QUIETCOOL SYSTEM



**STOP!** Read this page before proceeding! The manufacturer is NOT responsible for faulty installation or product damages caused through failure to fully read this guide BEFORE attempting installation.

### 1-1 Special Instructions

---

1. CHECK the box when opening for the first time; loose parts may shift during shipping. Check box contents against the section "Included in the Box" before proceeding with installation. Do NOT throw away the shipping box until completely satisfied with the product. **Note: Included controls will be located at the bottom of the box.**
2. BEFORE CUTTING into ceiling drywall, "measure twice, cut once." This ensures that you don't make mistakes in either selecting the wrong location for the intake grille, or cutting the wrong size hole.
3. READ wiring instructions BEFORE attempting to wire the product. Product warranty does NOT cover defective motors resulting from wiring errors.
4. DO NOT use any QuietCool ducted whole house fan in a home with all closed windows.
5. TEST your QuietCool unit before installation using included power cord. If the fan does not work, call us immediately.

#### Special Instructions to Contractors:

1. DO NOT take the Owner's Guide with you after the installation. This Owner's Guide has the serial number and warranty information of the homeowner's product.
2. DEMONSTRATE the use of the product to the customer before leaving the home, INCLUDING; explain the use of the timer, switch and/or smart application as applicable.
3. PROVIDE the customer with a completed invoice that clearly shows your company name, product model # and product serial number, date of sale and installation, and price paid. The manufacturer is not liable for warranty claims where proof of purchase cannot be verified.

#### Special Instructions to Do-it-Yourselfers:

1. DO NOT attempt to install any QuietCool cooling and ventilation system yourself if you lack sufficient skill and experience to do so.
2. WATCH the installation videos on the manufacturer website by visiting [www.QuietCoolSystems.com/support](http://www.QuietCoolSystems.com/support) or by scanning any QR code found in this guide that appears next to any instructional step.



## 1-2 Product Diagram

---

- A. Hanging Strap:** This strap is used to hang the fan from the rafters in the attic.
- B. Handy Box:** This is where all of the wiring for the fan is contained.
- C. Motor Housing:** This is the cylinder that houses the motor. Comes in diameters of 14", 16", 18" and 20".
- D. Fan Blade:** Computer-balanced three-blade fan system.
- E. Hand-guard:** Added for safety to keep hands out of the motor housing.
- F. Acoustical Duct:** R-4.2 acoustically lined duct for quiet operation.
- G. Damper Box:** Mounts to the ceiling and houses the damper doors to keep the home insulated.
- H. Damper Doors:** R-5 lined damper doors to prevent air movement between the home and attic.
- I. Ceiling Grille:** Aesthetically pleasing egg-crate grille.

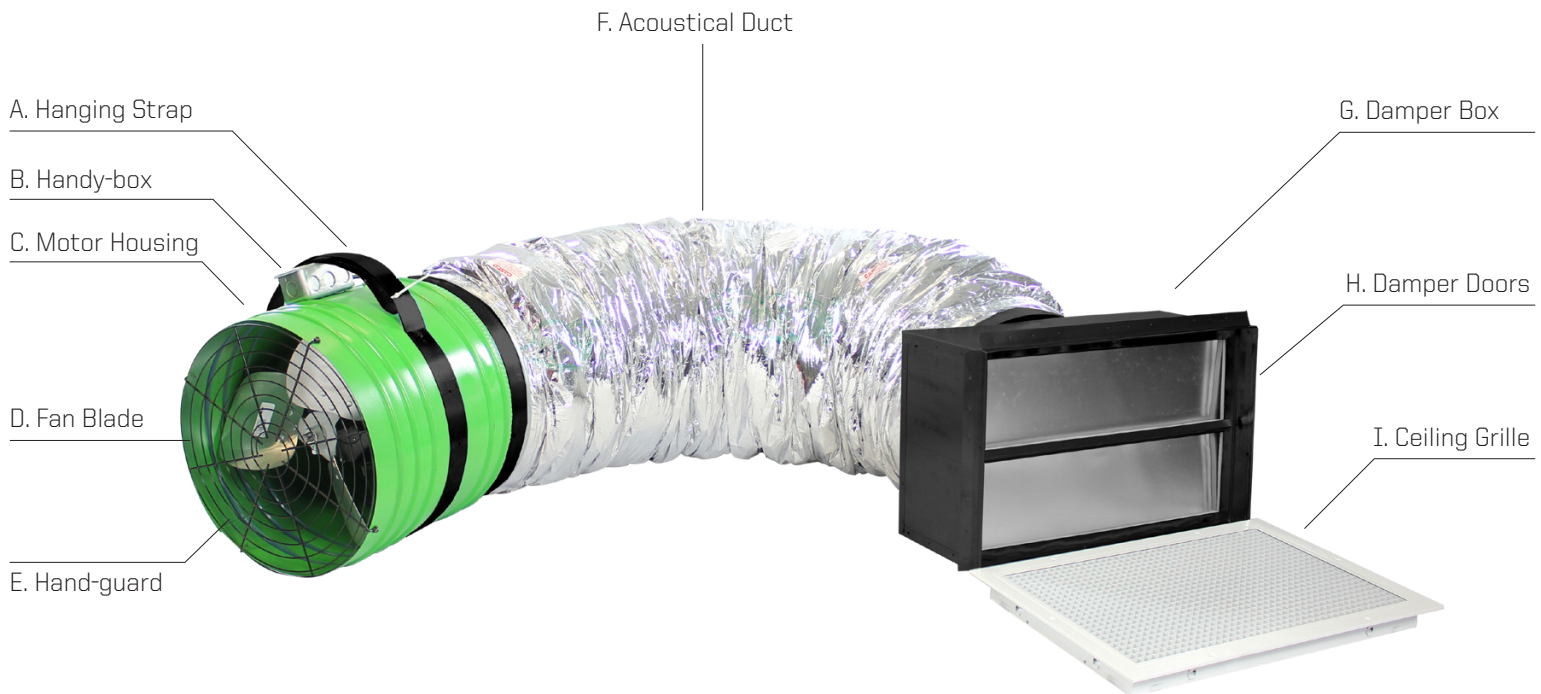

### 1-3 When to Run the QuietCool Whole House Fans

---

Anytime it is cooler outside than the inside of your home, the system will work effectively. In the summer this normally happens in the late afternoon to early evening, through to the next morning. We recommend running your fan through the evening. If you have a multi-speed fan, you will get the best cooling effect when you turn the fan on low after desired cooling occurs and let it run throughout the night.

QuietCool can also be used in the winter to heat your home during the day and exhaust the pollutants inside your home.

### 1-4 Where to Start Cooling the Home

---

We recommend cooling the area where you are going to be spending the most time for the next few hours. For example, in most family situations, the early evening is spent in the kitchen or family room area. Assuming this to be true, this is where you would want to start the cooling process.

Begin by opening a **few windows** in the area you are going to be spending your time and turn on all of your QuietCool fans at once, for maximum cooling. The cooler air outside will immediately begin to create a breeze in the home making you feel up to 10 degrees cooler, instantly. Opening windows too wide or opening too many windows will lessen the cooling breeze you feel.

The breeze will flow through your home and make its way to each QuietCool you have in operation.

As it gets later in the evening, and even cooler outside, you can begin to open windows in other rooms of your home, to prepare for bedtime. Then when it's time for bed, you should close all the windows in your main living space, but leave the windows in your occupied bedrooms open. This will provide each room with a cool breeze as long as desired. If you are using an 8 hour timer, you can automate your fan and have it turn off when you anticipate it being comfortable for sleeping. If you have a QuietCool installed in each bedroom as we recommend, you can enjoy the breeze and your privacy with your door closed.

### 1-5 Indoor Air Quality

---

You will want to ventilate your home on a very regular basis. Many studies such as one from the **Environmental Protection Agency** show that the air inside homes can be 2-5 times more polluted than the air outside, even in the smoggiest of cities. Your QuietCool system can greatly reduce this problem by bringing in fresh air and exhausting stale polluted air all year round.

---

If you have any trouble installing or operating your new QuietCool whole house fan, or for more tips on running the QuietCool, please visit our website at [www.QuietCoolSystems.com](http://www.QuietCoolSystems.com) or call us at 951-325-6340 for support.

**QuietCool is proudly designed and built in California.**

## 2. SYSTEM OVERVIEW

---

### 2-1 INTRODUCTION

---

#### **Congratulations on the purchase of your new QuietCool system!**

The QuietCool whole house fans dominate the market in energy efficiency and quietness. Whole house fans operate by pulling the cool air from outside your home, through the living space, into your attic, and out your attic vents. This accomplishes a cooling effect that can save you up to 90% off your A/C related energy costs depending on where you live. The difference between QuietCool and a standard whole house fan is a mix between it's astounding energy efficiency and it's jaw-dropping sound level. A standard whole house fan operates around 75dB; that's equivalent to a loud vacuum cleaner running! In contrast, our QuietCool whole house fans average at just around 45 dB; that's equivalent to quiet conversation!

The QuietCool system uses a cutting edge, patented design to get our sound levels down to a respectable level. Our fans suspend in the attic and use an acoustical duct that connects to a ceiling box and grille. The result is an easy installation and quiet operation.

Once the air outside is cooler than the indoor air, crack open a few windows, turn your QuietCool on, and enjoy the hot air being sucked out of your home and pushed out of your attic with a nice, cool breeze. While performing 15-22 complete air exchanges per hour, the QuietCool whole house fan system will force the hot stale air out of the attic which will help your house stay cooler during the hotter hours of the next day!

### 2-2 Features

---

- High Efficiency ECM Motor
- Patented Design
- Built in USA
- R5 Insulated Dampers
- 10 Year Warranty



## 2-3 System Venting Recommendation







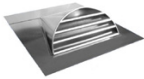

**FOR OPTIMAL PERFORMANCE! - 1 SQUARE FOOT OF NET FREE VENTING PER 750 CFM**

Venting plays a very significant role in the performance of whole house fans. QuietCool recommends a minimum of 1 SQ. FT. for every 750 CFM in the QuietCool system. If an attic has at least 1:750 attic venting, the QuietCool system will operate efficiently and effectively. If an attic has less than 1:750 attic venting, the system may not operate as efficiently, or effectively, as it could with 1:750 attic venting. But don't worry, the system will still operate if there is not enough venting.

Insufficient venting is a very simple problem to fix. Roofing contractors can add extra venting to most homes simply and easily. The most common types of venting is shown in the chart below.

### RECOMMENDED VENTILATION: 1 SQ. FT FOR EACH 750 CFM

Vent Type	Model Type	Average Size	Venting Sq. Ft.
Gable vent		12" x 19.5"	1.20
Dormer Vent		14" x 8"	0.70
Eave Vent		4" 5" 6"	0.03 0.04 0.07
Ridge Vent		4' - 12'	0.125 per ft
Soffit Vent		16" x 4" 16" x 6" 16" x 8"	0.19 0.29 0.39
O'Hagin Vent		Low/Medium Profile Tapered Low Profile Low Profile Flat High Profile	0.5 0.6 0.68 0.68
Turbine Vent		8" 12" 14"	.35 .79 1.1

\*Note: This table is only a guideline and is not a guarantee of venting capacity.



### 3. INSTALLATION

#### TOOLS YOU WILL NEED

- Drywall saw
- Phillips screwdriver
- Pencil
- Power-drill
- Philips bit

#### 3-1 Installing QuietCool



**NOTE:** Be sure to plug in your fan before attempting to install to ensure that the fan is operational and the fan blade spins freely.

Installing the **QuietCool** system is very easy. Simply follow the steps given below:

1. Determine from down below in which areas you would like to install your **QuietCool** fan. Go up into the attic to mark the exact location for the fan. Make sure you have a minimum of 30" of clearance. Take the cardboard cut-out template and a small screwdriver with you. Make sure the template fits between the framing.

The template size varies depending on which model of **QuietCool** fan you are installing:

QuietCool Fan Model	Template Size
ES-1500	14-1/4" x 14-1/4"
ES-2250	14-1/4" x 18-1/4"
ES-3100	14-1/4" x 22-1/4"
ES-4700 & ES-5400	14-1/4" x 30-1/4"
ES-6400	14-1/4" x 36-1/4"

2. When you have chosen your exact spot, place the provided template on the spot and mark it at each corner by pushing the screwdriver through at each corner to make a hole so that you can find it from below.



#### Installation Video:

Watch the video by scanning the QR code or visit [www.QuietCoolSystems.com/support](http://www.QuietCoolSystems.com/support)

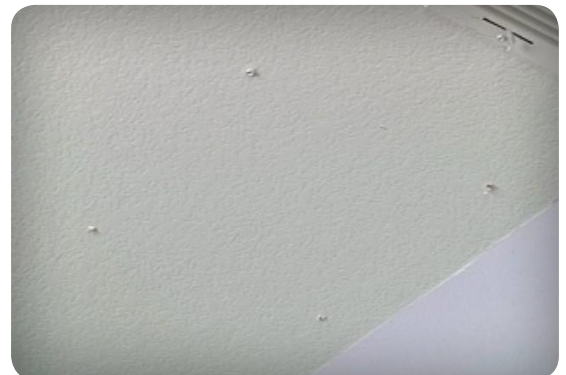



3. From below, place the cut-out template on the ceiling, making sure that you have at least 2 inches of clearance all around it. While holding the template in place, mark its outline with a pencil.



4. Using a drywall saw or similar device, cut out the hole in the ceiling.



5. Open and unpack your **QuietCool** fan.



**TIP:** If your attic is very tight, you may want to wire your QuietCool motor housing before bringing it into the attic. Please follow the wiring diagrams that start on page 13.

6. Take the main assembly, which includes the motor housing, damper box, and duct into the attic through the crawl hole and move into position near the ceiling cut-out hole.



**TIP:** If your attic access is far from your fan location, you can remove the duct from the motor housing and pass the motor housing, duct, and damper box through the ceiling cut out hole and reattach the duct to the motor housing in the attic.



7. Hang the motor head from the rafters by fastening the metal strapping that is attached to the motor heads to the rafters with the wood screws. Make sure that the handy box on the motor head is at the very top. Secure duct to damper box using three black sharp screws. Make sure the housing is angled slightly up and the duct has a gentle 90 degree bend to help reduce noise level. The angle is important so the fan does not disturb any blown-in insulation in your attic.



**NOTE:** Once your QuietCool fan is hung, it's time to go below and install the damper box and ceiling grille.



**NOTE:** If you are installing the damper box with a vertical adapter, please follow the instructions on page 12.

8. Look through the hole and make sure there are no kinks or twists in the ducting. Pull the damper box down through the hole in the ceiling.



**NOTE:** The QuietCool Damper Box includes removable flanges in the case that you are installing the damper box between studs that are exactly 16" on center. To remove the flanges, simply take a screwdriver and pry between the flange surface and the damper box. Do this along the entire edge of the flange and it will pop off.



**NOTE:** The damper box flange is designed to sit on the backside of the drywall, inside the attic. Do not attempt to install the damper box with the flanges on the outer side of the drywall in the home.

9. Using the included drywall screws, fasten the damper box to the drywall and the joist in the attic.

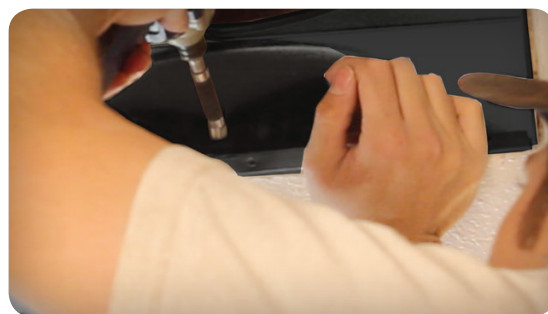

**NOTE:** Remember that you must fasten the damper box to the ceiling joists AND drywall. The purpose of this is to make sure the damper box stays in place when you are screwing in the grille. If you do not fasten the damper box to the drywall, the damper box will not stay in place when attempting to screw in the grille.



10. Remove ceiling grille and screws from its packaging. Center the grille over the damper box. Install the grille with the white screws provided by screwing through the drywall into the flange of the damper box.



**NOTE:** Some ceiling surfaces are uneven and may cause a small gap to be present. This can easily be caulked later if excessive.

11. Return to the attic. Using the nylon straps and the long wood screws provided, support the duct to the framing. This will stabilize the entire assembly. Replace any insulation that was removed. The installation of the fan is now complete



**NOTE:** Local building codes and standards must be adhered to in the installation of this unit.



**NOTE:** Additional insulation can be added to the top of the damper box to provide additional sound dampening



**AVOID BACK DRAFTS:** Care should be taken to avoid back drafting combustion appliances that are installed in the conditioned space. Whole house fans are capable of pulling large quantities of air, from the home, particularly if not enough windows are open. This could easily back draft gas appliances located inside your home. Take care if you have gas appliances installed inside of your home.



### 3-2 Installing Vertical Adapter (vertical adapter sold separately)

---

A vertical wall adapter allows a damper box to be installed in the wall instead of the ceiling. A vertical adapter is installed on the wall with the damper box mounted diagonally to the wall so the damper doors close properly when the fan is turned off.



**NOTE:** Measure the studs in your wall. If they are 16" on center, you will need to follow steps 1 through 4 completely. If they are wider than 16" on center, you will only need to follow steps 1 & 4.



**NOTE:** The damper box MUST be installed with the damper doors oriented vertically. If the damper box is mounted on the wall with the damper doors horizontally, the damper doors will not operate correctly.

1. Note the T (TOP) side of the vertical adapter. Place the vertical adapter with the T side up onto the damper box with the side that has only two flanges, flush on the damper box.
2. If you have studs spaced at 16" on center, you will need to remove certain flanges on the damper box and vertical adapter. Using a flat head screwdriver, remove the two side flanges on the vertical adapter. **(See Figure 1)**

Figure 1

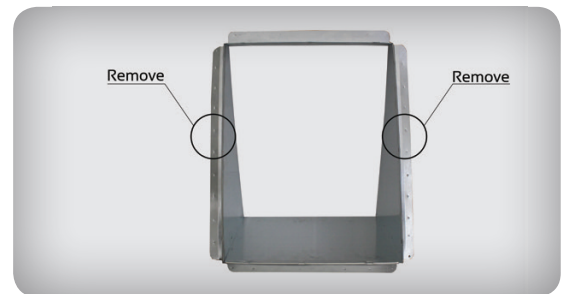
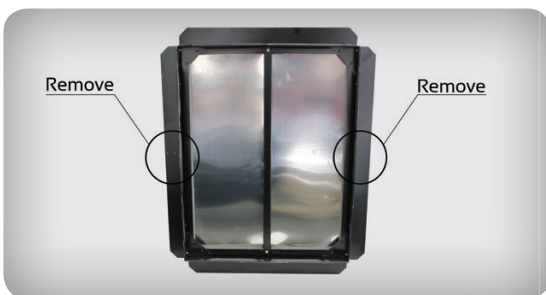
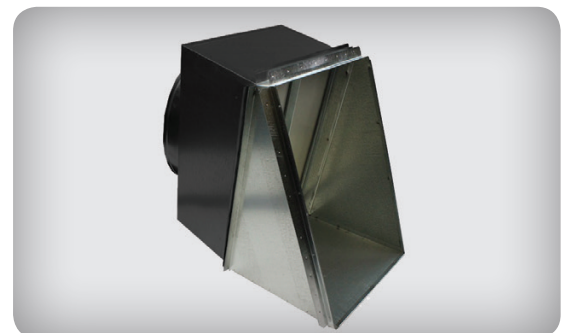

Figure 2



3. Using a flat head screwdriver, remove the two side flanges on the damper box. Make sure that you are removing the flanges on the same side as the flanges you removed on the vertical adapter. **(See Figure 2)**

Figure 3



4. Using the included black sharp screws, attach the vertical adapter to the damper box by screwing them together through the two remaining flanges. **(See Figure 3)**
5. The vertical adapter is now installed. Go back to step 8 on page 10 and continue your installation.

#### Vertical Adapter Video:

Watch the video by scanning the QR code or visit [www.QuietCoolSystems.com/support](http://www.QuietCoolSystems.com/support)



## 4. WIRING

---



**NOTE:** Wiring Diagrams are for examples only and wiring should be done by an experienced electrician. 12 or 14-gauge romex is common. Check your local building code before choosing the wire type.

### 4-1. Single Speed Wiring

---

For wiring of the ES-1500 with one speed.

### 4-2. Two Speed Wiring

---

For wiring of the ES-2250, ES-3100, ES-4700, or ES-5400 with two speeds.



### 4-4. Two Motorhead Wiring

---

For wiring of the ES-6400 with two speeds.



**NOTE:** QuietCool whole house fans can be used with the included power cord with a plug outlet, but will only operate on high speed. The system will also work with a wireless system using the power cord. The main purpose of the power cord is to test fan operation.



**NOTE:** Multi-speed fans require constant power being supplied to the motorhead. Read the wiring instructions and wiring diagrams carefully to ensure proper wiring.

## 4-1 Single Speed Wiring (for ES-1500)

1. For this installation, you will need (2) 2 wire Romex, single-gang retrofit box, and an 8 Hour Timer. Using the included wire nuts, tie the black wire from the first 2 wire Romex from the power source to the black wire on the timer. **(see Figure A)**
2. Using a wire nut, tie the black wire on the 2 wire Romex from the fan to the red wire on the timer.
3. Using a wire nut, tie the bare copper wires together with the green ground wire on the timer.

Figure A

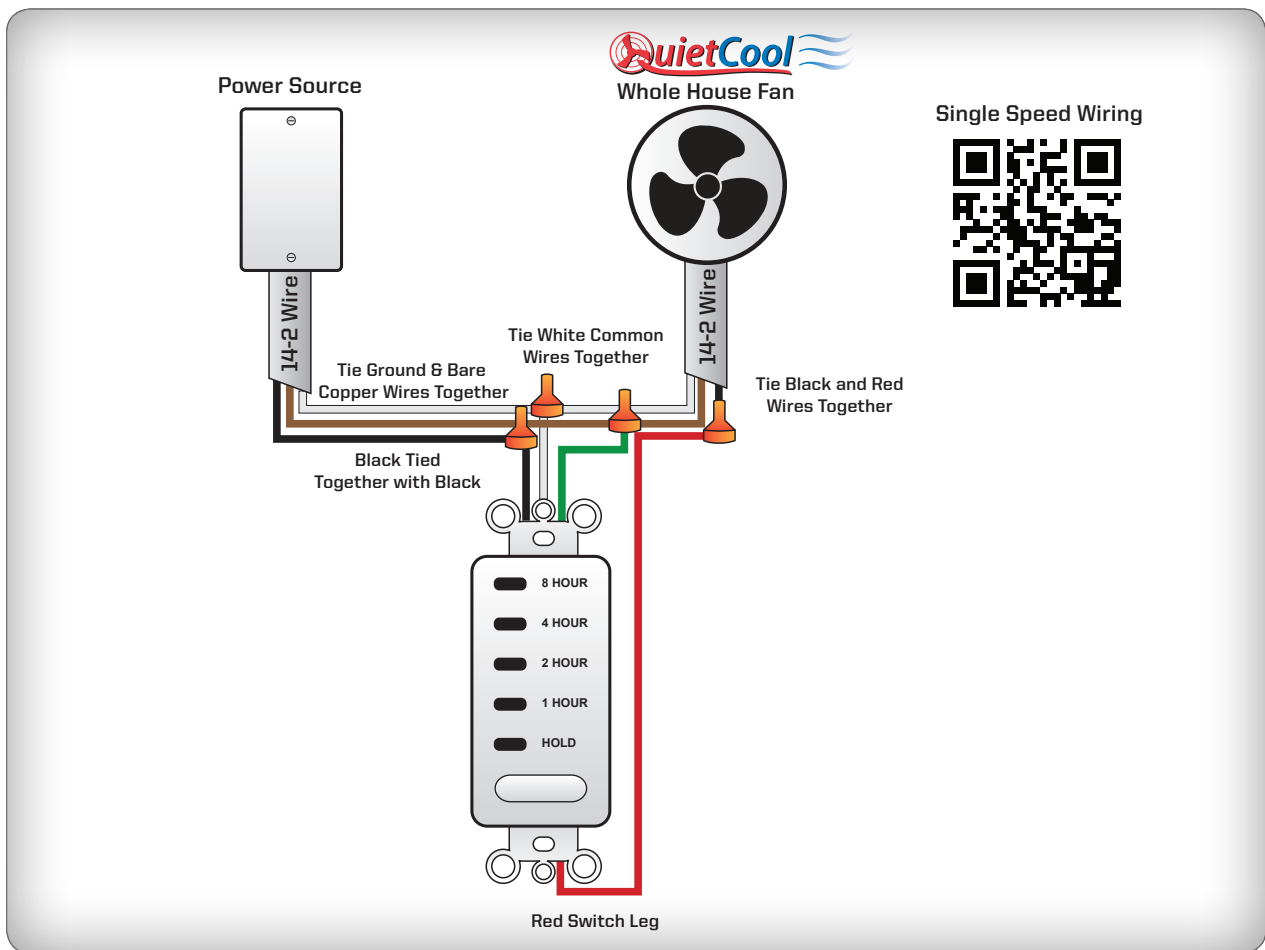

4. Using a wire nut, tie the white common wires from the Romex to the white common wire on the timer.
5. Begin wiring the fan by opening up the handy box. Take off the wire nuts within the handy box. Unscrew the green ground wire. Detach the green ground wire from the power cord. **Remove the power cord.** Re-attach the ground screw and wire to the handy box. Cut your green ground wire in half and strip both sides. **(see Figure B)**



6. Feed the 2 wire Romex through the handy box. Using the included wire nuts, tie the black wires together. Tie the white common wires together. Tie your bare copper wire and green ground wires together.
7. Carefully reinstall the handy box cover.

Figure B

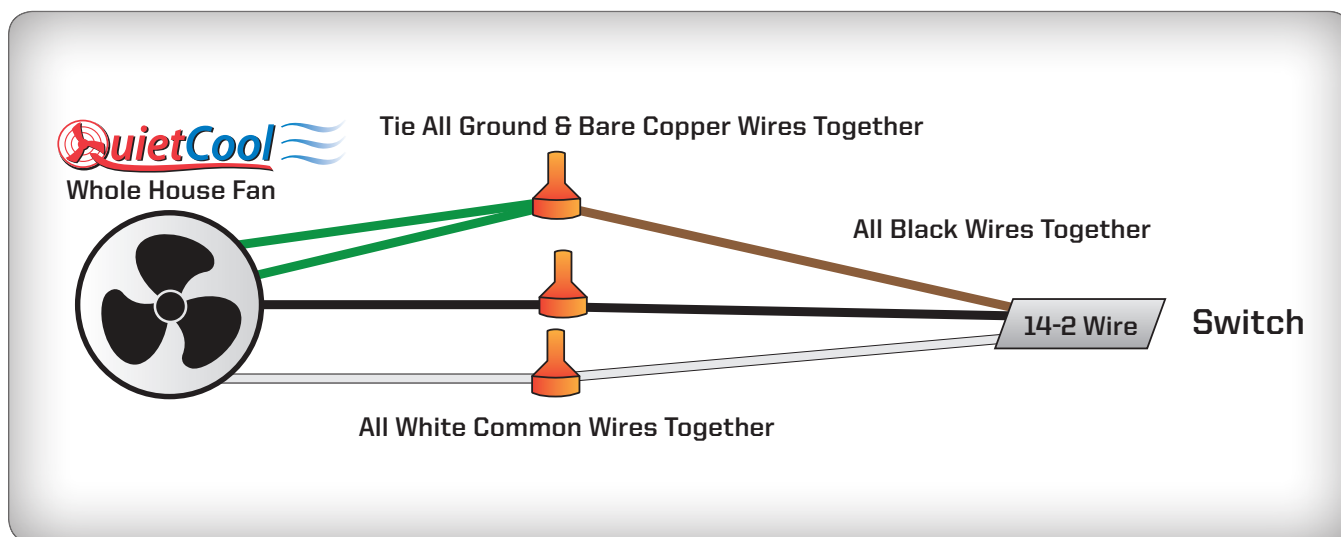

#### 4-2 Two Speed Wiring (for ES-2250, ES-3100, ES-4700, ES-5400)

1. For this installation, you will need (3) 2 wire Romex, double-gang retrofit box, an 8 Hour Timer, and a HIGH-LOW-OFF Switch.
2. Using your first 2 wire Romex, tape the white common wire because we are going to use it for low speed. Attach the white wire to the top gold screw on the right of the switch. Then, attach the black wire to the bottom gold screw. **(see Figure C)**
3. With a piece of bare copper wire, attach it to the green ground screw on the switch.
4. Using the second 2 wire romex that's going to your timer, use one of the supplied wire nuts to tie the black wire to the black wire on the timer. Tie the white wire from the 2 wire Romex to the white wire on the timer.
5. Using a wire nut, tie all bare copper wires together with the green ground wire on the timer.

Figure C

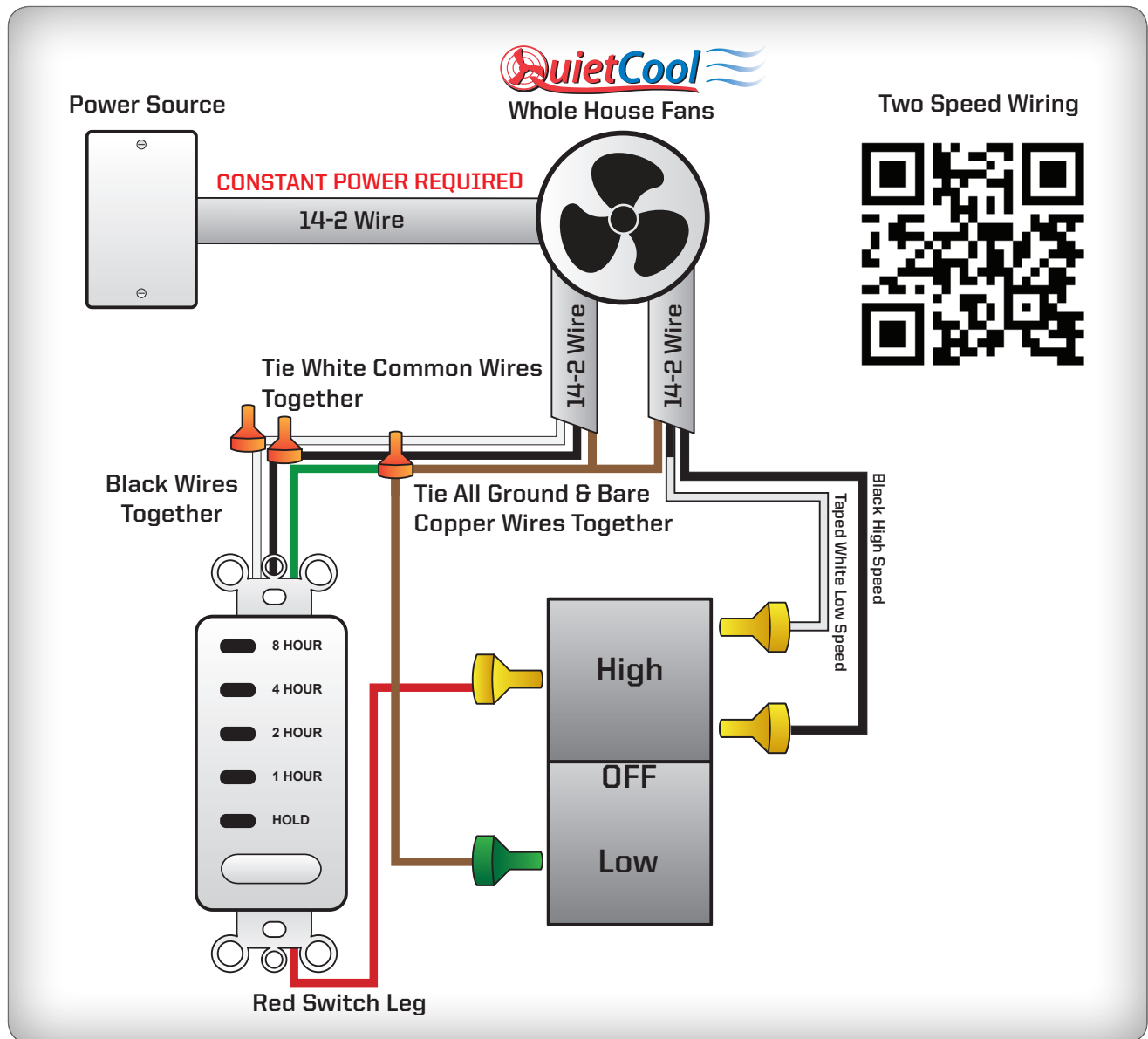

6. Attach the red leg wire from the timer to the top gold screw on the left of the switch. Finish up the installation of the timer and switch and switch cover plate.



**NOTE:** If wiring the ES-3100, ES-4700, or ES-5400, please skip to step 12. If wiring the ES-2250, follow steps 7 through 11

Figure D

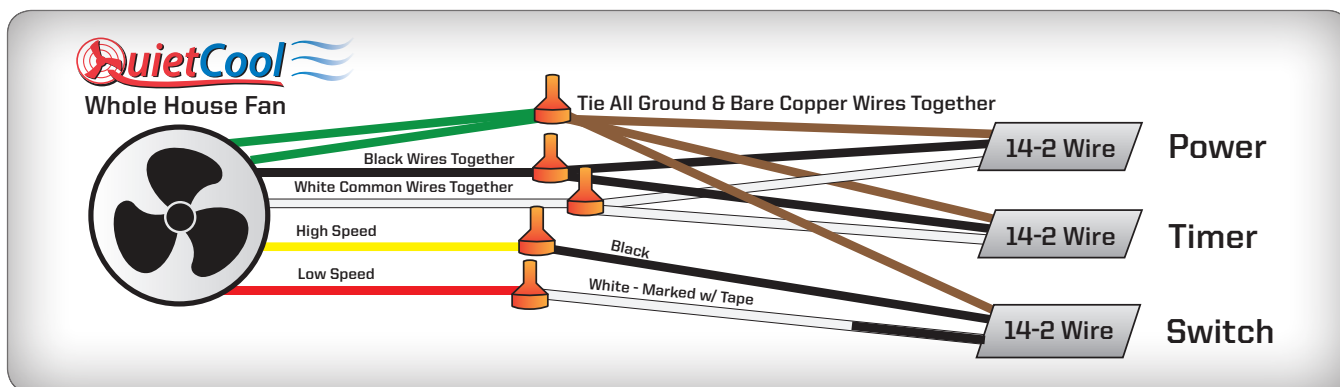

7. Begin wiring the fan by opening up the handy box. Take off the wire nuts within the handy box. Detach the green ground wire from the power cord. **Remove the power cord.** Re-attach the ground screw and wire to the handy box. Cut your green ground wire in half and strip both sides.  
**[see Figure D]**
8. Feed the 2 wire Romex from your switch into the handy box. Tape the white wire on this end of the Romex. Tie the yellow & black wire together for high speed. Tie the red and taped white wire together for low speed.
9. Feed the 2 wire Romex from your timer into the handy box. Feed the 2 wire Romex from your power source into the handy box.
10. Tie the three remaining black wires together. Tie the three remaining white common wires together. Tie the three bare copper wires and the two green ground wires together.
11. Carefully reinstall the handy box cover.



**NOTE:** Continue to the next page if wiring the ES-3100, ES-4700, or ES-5400.

Figure E

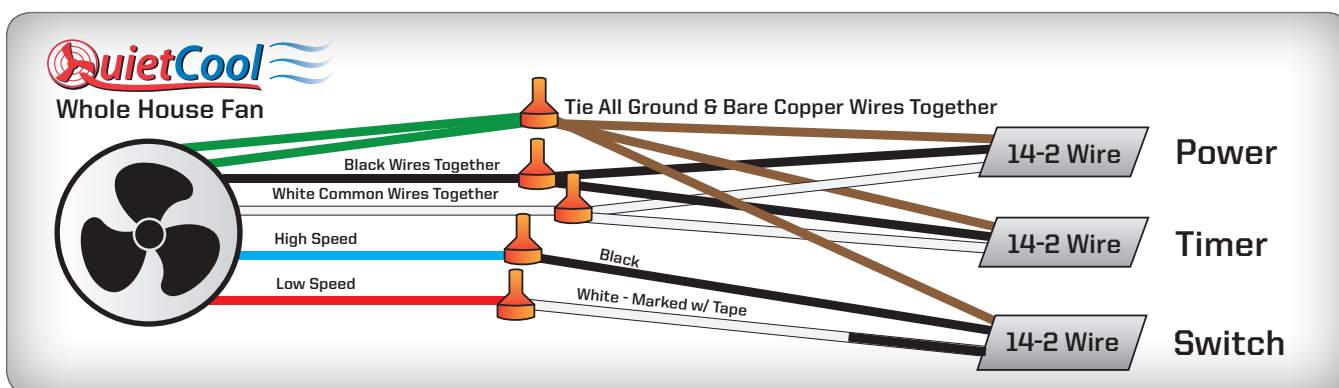



12. Begin wiring the fan by opening up the handy box. Take off the wire nuts within the handy box. Detach the green ground wire from the power cord. **Remove the power cord.** Re-attach the ground screw and wire to the handy box. Cut your green ground wire in half and strip both sides. **(see Figure E on page 17)**
13. Feed the 2 wire Romex from your switch into the handy box. Tape the white wire on this end of the Romex. Tie the blue & black wire together for high speed. Tie the red and taped white wire together for low speed.
14. Feed the 2 wire Romex from your timer into the handy box. Feed the 2 wire Romex from your power source into the handy box.
15. Tie the three remaining black wires together. Tie the three remaining white common wires together. Tie the three bare copper wires and the two green ground wires together.
16. Carefully reinstall the handy box cover.

---

#### 4-3 Two Speed Wiring (for ES-6400)

---

1. For this installation, you will need (4) 2 wire Romex, an 8 Hour Timer, and a Double stack combination Switch.
2. Using the 2-wire Romex from the first fan motor head, attach the black wire to the top gold screw on the right. Using the 2-wire Romex from the second fan motor head, attach the black wire to the bottom gold screw on the right. **(see Figure F)**
3. Attach the red wire from the 8 Hour Timer to the bottom black screw on the switch.
4. Using the 2 wire Romex from your power source, tie the black wire to the black wire on the timer with a wire nut.
5. Take a piece of bare copper wire and attach it to the green ground screw on the switch. Using a wire nut, tie all copper wires together with the green ground wire from the timer. Tie all the white wires together. Finish the installation of your switches and switch cover plate.
6. Open up the handy box on the first motorhead. Unscrew the green ground wire and detach the green ground wire from the power cord. **Remove the power cord.** Reattach the green ground wire to the handy box. Cut your green ground wire in half and strip both sides.

Feed the 2-wire Romex from your switch into the handy box. Tie the blue & black wire together for high speed.

Figure F

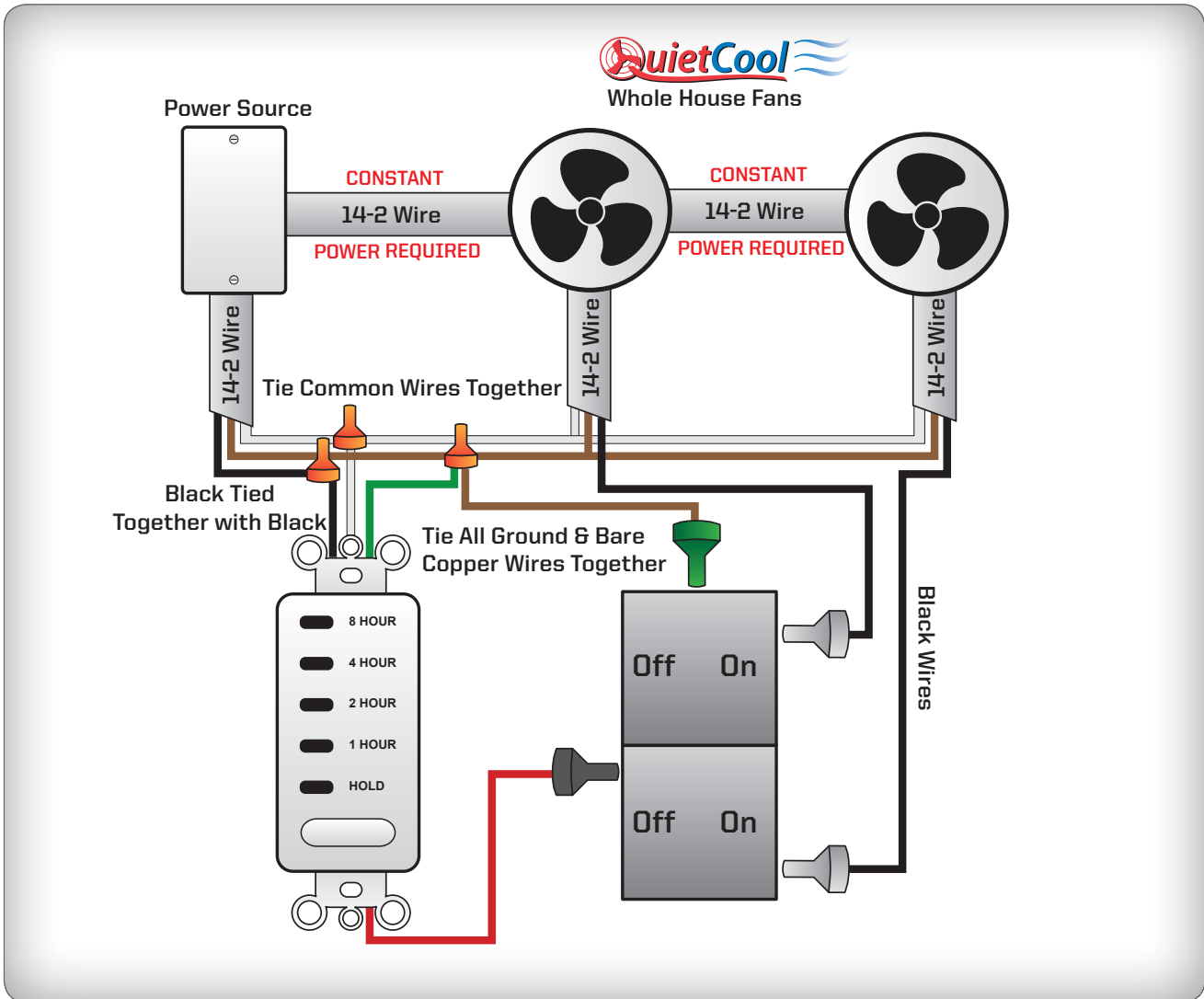
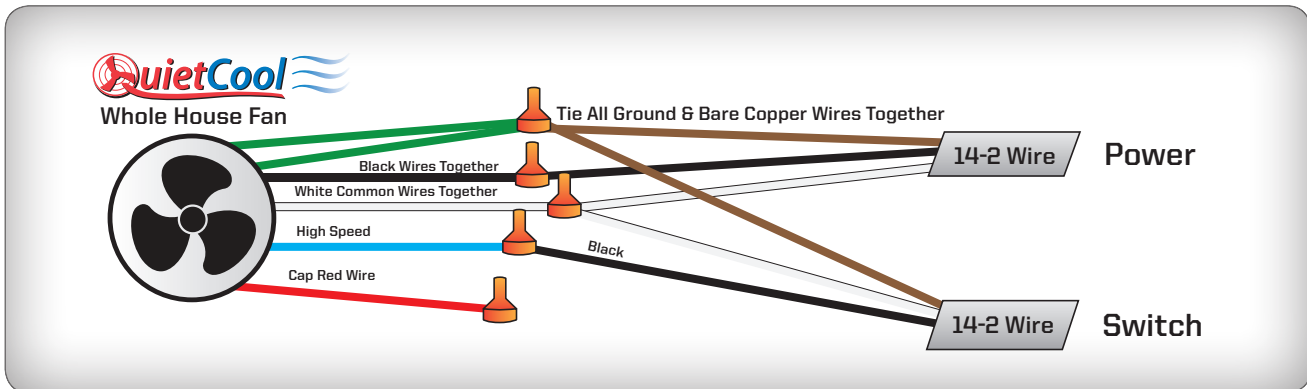

Figure G



**Note:** Wiring instructions continued on page 20.

7. Feed the 2 wire Romex from your power source into the handy box. Tie the remaining black wires together. Tie the remaining white common wires together. Tie the bare copper wires and the two green ground wires together. **(see Figure G on page 20)**
8. Open up the handy box on the second motorhead. Unscrew the green ground wire and detach the green ground wire from the power cord. **Remove the power cord.** Reattach the green ground wire to the handy box. Cut your green ground wire in half and strip both sides.
9. Feed the 2-wire Romex from your switch into the handy box. Tie the blue & black wire together for high speed.
10. Feed the 2 wire Romex from your power source into the handy box. Tie the remaining black wires together. Tie the remaining white common wires together. Tie the bare copper wires and the two green ground wires together. **(see Figure G on page 20)**









10 YEAR LIMITED WARRANTY  
QC ES (ENERGY SAVER) LINE WHOLE HOUSE FANS



QC Manufacturing Inc. extends this warranty to the original purchaser of the following QuietCool Energy Saver Line Models --- QC ES-1500, QC ES-2250, QC ES-3100, QC ES-4700, QC ES-5400 and QC ES-6400 --- installed and used in a residence under normal conditions within the United

- A. Ten year coverage applies to the QuietCool motor fan assembly. At our option we will repair or replace any part of the assembly should it fail to operate during the first ten years from the date of original purchase.
- B. One year coverage for all other components including grilles, housings, controls, and accessories furnished by QC Manufacturing, Inc. At our option, we will repair or replace any part which fails as a results of defective material or workmanship during the first year from the original date of purchase.
- C. This warranty does not cover any of the following:
  - 1. Accidental or consequential damage resulting from the operation of our equipment or any malfunction thereof.
  - 2. Cost of service calls to diagnose the cause of problems or the labor charge to un-install any components.
  - 3. Product failure or damage due to faulty installtion, abuse, misuse, unauthorized alteration to factory specs, lack of maitenance, or transportation damage.
  - 4. Shipping or postage for warranty claims.
- D. To obtain service under this warranty, first contact the dealer where you purchased the equipment. If you are unable to find or reach your dealer, contact Customer Service at QC Manufacturing, Inc. In order to process a warranty claim, you must have your serial number as well as your proof of purchase. QC Manufacturing, Inc. will not process a warranty claim without a serial number. Your serial number is located on the fan motorhead as well as on the back of this Owner's Guide.

This warranty is the only warranty extended by QC Manufacturing, Inc. to purchasers or suppliers of our equipment. QC Manufacturing, inc. disclaims all other warranties, express or implied, that arise by operation of the law. Where consumer may have additional warranty rights in accordance with federal and state law, such rights shall supersede those stated herein.

Rev. 10/20/16

**QC Manufacturing, Inc. Customer Service**

43352 Business Park Dr.  
Temecula, CA 92590  
www.QuietCoolSystems.com  
951-325-6340

QuietCool is Proudly Designed and Built in California

## Fan Serial Number Information



Retain for your records. Serial number is required for warranty purposes.

