

# Steel All Season Security Door Installation: For Arbor and Estate models

**STOP PLEASE READ ALL INSTRUCTIONS BEFORE YOU BEGIN INSTALLATION**

**RECESSED MOUNT**

Parts and tools required - WE RECOMMEND THAT YOU HAVE A HELPER FOR THIS INSTALLATION.

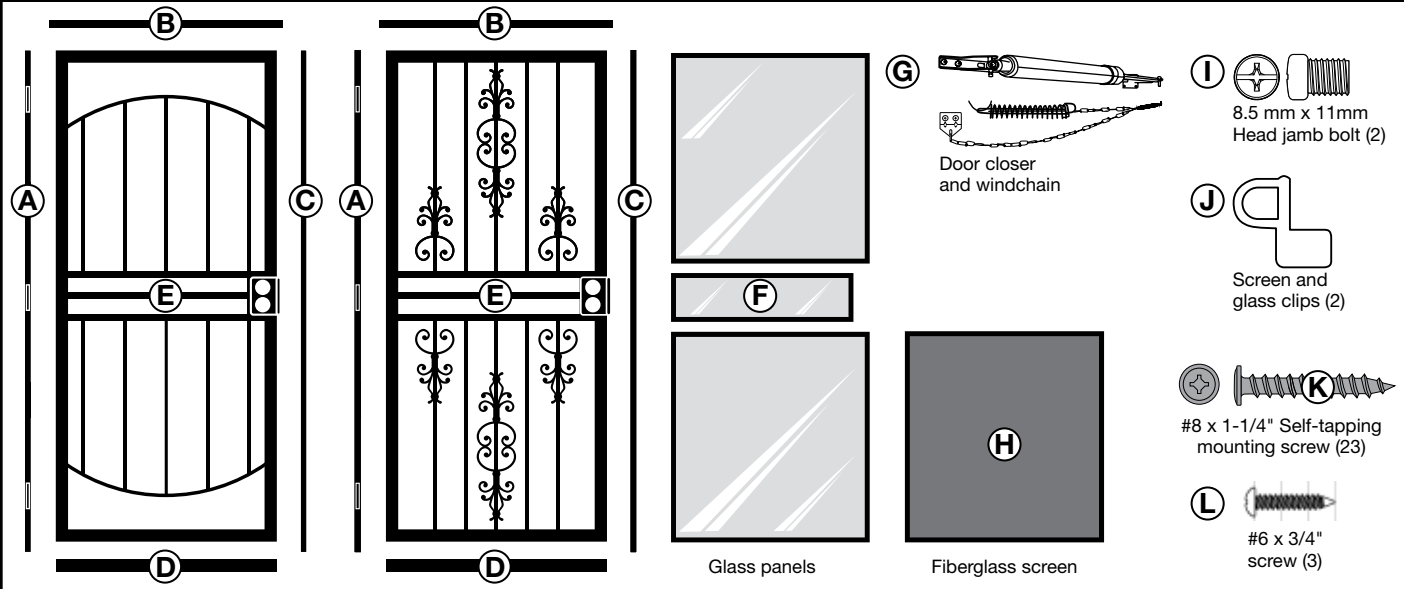

- Included:**
- A) Door/hinge-side Z-bar jamb assembly
  - B) Head/Top jamb
  - C) Lock-side Z-bar jamb
  - D) Bug sweep/expander bar
  - E) Door panel
  - F) Glass panels
  - G) Door closer and windchain
  - H) Fiberglass screen
  - I) Head jamb bolt
  - J) Screen and glass clips
  - K) Self-tapping mounting screw
  - L) Bug sweep/expander mounting screw

**Recommended Tools:**  
Measuring tape, pencil, level, power drill and 1/8" drill bit, hammer, hack saw, 3/8" wood chisel, flat-blade screwdriver, Phillips-head screwdriver, safety glasses, wood shims, utility knife, saw horses

## 1 Preparation for installation

With glass panels (F) facing up, lay the door (E) flat on sawhorses or other elevated flat surface that will allow for cutting. Use the packing carton underneath as protection against scratching. Remove the bug sweep/expander bar (D). Remove the screen panel (H) and glass panels (F) by rotating glass and screen clips 90°. Carefully set aside.

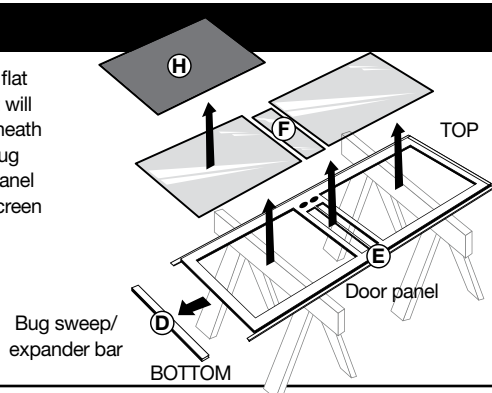

## 2 Determine door swing

Your Steel All Season Security Door is designed as an out-swing door and will swing away from the house when opened. The handle of primary door and security door should be on the same side. Determine which direction your security door should swing and compare to the preset swing of the product. If the door is already the correct swing for your entry, skip to Step 4. Otherwise, follow Step 3 to reverse the hinge side for proper door swing direction.

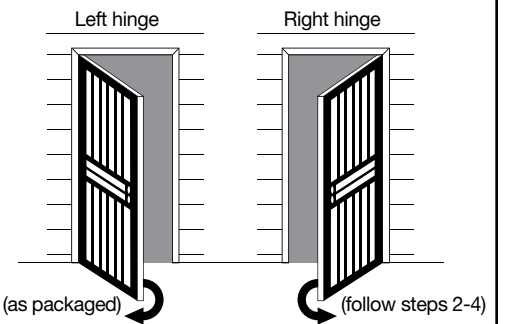

**Note:** All doors come packaged as left hinge, right open.

## 3 Reverse door top and side jambs to change swing direction if needed

**Fig. 1 -** Remove head/top jamb (B) from top of door (E) by unscrewing the two Phillips-head jamb bolts. Set aside while jambs are readjusted.

**Fig 2 -** Open hinge-side of Z-bar jamb (A) to expose hinge screws. Remove the two Phillips-head screws from each of the three hinges. Slide hinge-side Z-bar jamb toward what will now be the bottom of the door (where the top/head jamb was in Fig. 1) to the next pre-drilled hole. Be sure holes are aligned. Replace the two Phillips-head screw in each of the three hinges but do not over tighten.

**Fig. 3 -** From lock side of the door, remove the Phillips-head screw from each pre-hang clip (DO NOT REMOVE PLASTIC CLIP FROM DOOR). Slide lock side Z-bar jamb (C) toward what is now the bottom of the door to the next pre-drilled hole below; replace the Phillips-head screws in each of the two pre-hang clips but do not over tighten.

**Fig. 4 -** Move top/head jamb to what is now the top of the door. Tighten the screws for the hinges and pre-hang clips. Reinstall top/head jamb (B) with existing screws.

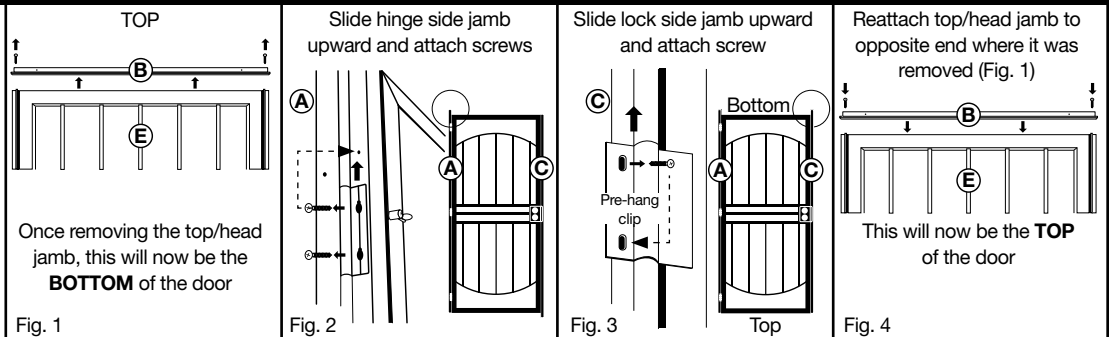

## 4 Fit Steel All Season Security Door to your opening

**Fig. 5 -** Measure the inside height of the opening where the door is to be installed.

**Fig. 6 -** Subtract 1/8" from the height - this is your trim length. Starting at the top of the door, measure and mark each vertical Z-bar jamb (A & C) piece at your trim length. Cut the bottom of each of the jambs.

Measure opening height and subtract 1/8" (For example, if opening is 80", your jamb cut height will be 79-7/8").



Cut both Z-bar jambs (A & C) at the measurement determined in Fig. 5.

**IMPORTANT:** Be sure to measure from the top before cutting.

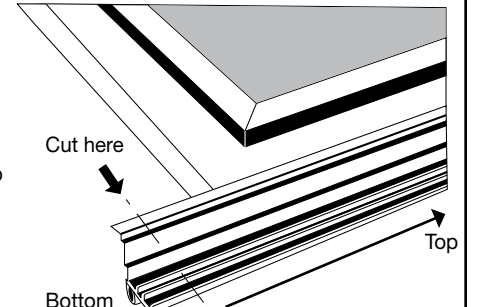

## 5 Mount Steel All Season Security Door

**Fig. 7 -** Place the door into the opening making sure it is level and plumb. With the door in place, drill a 1/8" hole approximately 1/2" deep through each of the pre-drilled holes in the Z-bar jambs (A & C) and into the doorway trim. Starting with holes (1-3), insert mounting screws (K) and tighten.

**Fig. 8 -** Remove screws on pre-hang brackets and remove brackets. Through the remaining holes in the Z-bar jambs (A & C) and top/head jamb (B), drill a 1/8" hole approximately 1/2" into the doorway trim. Insert mounting screws (K) into holes (4-12) and tighten.

**Fig. 9 - Open door.** On the inside of hinge side Z-bar jamb (A) insert mounting screws (K) into holes (13-17) and tighten. Lastly, re-install glass and screen panels (F & H) and secure with glass and screen clips in proper position. Close and open door to ensure proper fit, adjust if necessary.

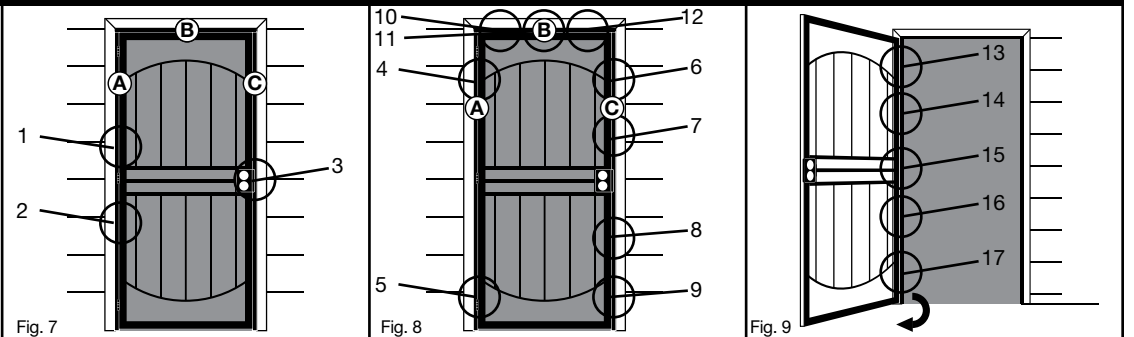

## 6 Install hardware and door closer

To install, follow the manufacturer's instructions included with the door closer, windchain, and handleset hardware. (2-3/8" backset handle must be purchased separately)

## 7 Install bug sweep/expander bar

**Fig. 10 -** With the door open, fit the bug sweep/expander bar (D) onto the bottom of the door. Close the door and position the bug sweep/expander bar so that the bar fits snugly against the threshold but does not restrict door operation. From inside the door, drill 1/8" holes through the bug sweep/expander bar and secure the expander bar to the door with the provided #6 x 3/4" screws.

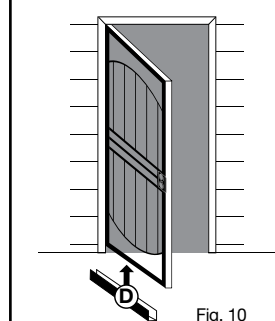

## 8 Final touch up and maintenance suggestions

**Fig. 11 -** After installation is complete, apply touch up paint (not included) to screws and/or surface of door in order to cover any minor scratches that may have resulted during installation.

Caulk around the outside of the all season security door jamb frame, using paintable caulk, and paint to the desired color.

To clean your door use a mild soap and water solution. Do not use any abrasive cleaners on any part of your door, this will damage the powder-coat finish and void your paint warranty.

Glass Cleaning - remove individual glass panels by rotating clips 90°. Clean glass panel. Re-insert glass panel and secure with clips.

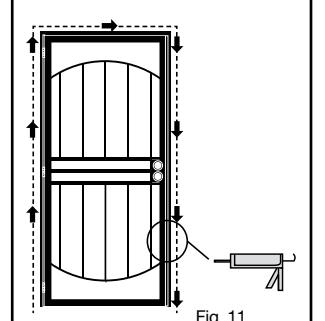

## Warranty Information

Your Unique Home Designs Security Door is warranted against manufacturing defects of the welded frame, pickets, and lock box for as long as you own the home upon which the door is properly installed. If structural defects occur in these areas we will, at our discretion, repair or replace the door. Replacement items may vary in style due to changes in suppliers and product. In addition, the paint finish is warranted not to blister, crack, or fade for one year from the purchase date. Damage due to rust is excluded from this warranty. Screens, glass and hardware are also excluded from this warranty. This warranty does not cover damage caused by vandals, break-ins, or attempted break-ins. This warranty is voided if the product is modified in any way. Any problem caused by abuse, misuse, failure to maintain warranted item properly, adjustments due to settling of the structure that the product is mounted on, or acts of God, are not covered. Unique Home Designs assumes no responsibility for labor costs of any kind for removal, replacement of parts, repairs, or reinstallation. To make a claim under this warranty, send a brief written description of the problem, a picture of the problem, proof of purchase, and your contact information to: Unique Home Designs, 973 N. Colorado Street, Gilbert AZ. 85233 Attn: Warranty Claims

VIEW INSTALLATION VIDEOS AND LATEST INFORMATION AT [helpmeinstallit.com](http://helpmeinstallit.com)