



Fab Glass Gym Mirror kit (Mirror with Safety Backing) Installation Manual



**FAB GLASS
AND MIRROR**

 www.fabglassandmirror.com  Call: +1 888-474-2221  Fax: (614)-334-4919

 Office Timing: 8:30 - 18:00 EST  info@fabglassandmirror.com

Thank you

Congratulations on the purchase of your new gym mirror! We've made it very easy to install. Please read the following instructions carefully before you begin to install the gym mirror. Using any other methods to install the mirror may lead to it breaking and will invalidate the warranty.

About Your Safety Backing Mirror

This mirror was designed with safety in mind. It is laminated on the back with a layer of woven tape. In case of broken glass, the tape's adhesive layer will hold the shards in place, minimizing the potential of injury.

Mirror Handling Cautions

Please read every step in the instructions before you begin installation. You are responsible for assembling, installing and taking care of your mirror according to the instructions. Users who fail to heed the instructions run the risk of injury, so please be careful and work with caution.

When applying the mirror glue, work in a well ventilated area to avoid breathing in fumes.

REQUIRED AND RECOMMENDED TOOLS

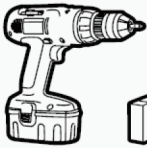

Drill/Driver

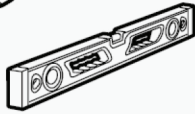

Level

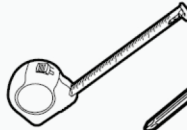

Tape Measure

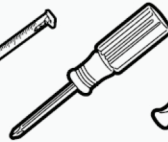

Screw Driver



Hammer



Lead Pencil

HARDWARE INCLUDED PER YOUR ORDER

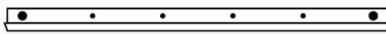

J-Bar (Qty - 1)

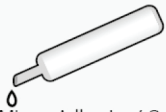

Mirror Adhesive (Qty - 1)



Mirror Clip (Qty - 4)



Anchor
(Qty - 4/6)



Screw
(Qty - 4/6)

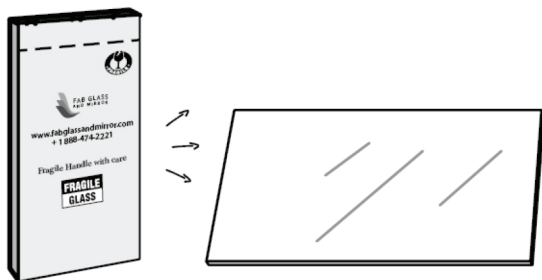

Remove packaging from your gym mirror.

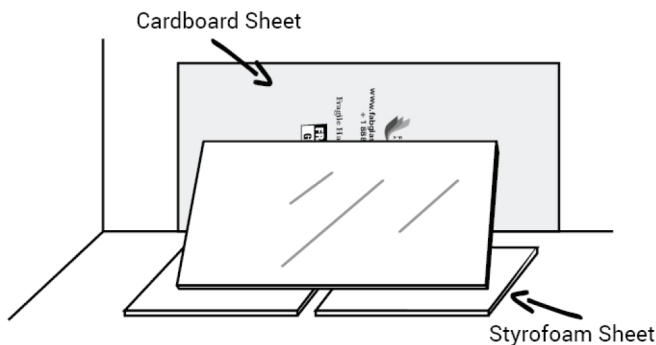

Place the piece of cardboard against the mirror at the wall to protect it during installation.

Place the styrofoam sheet on the floor for additional protection as you install your gym mirror.

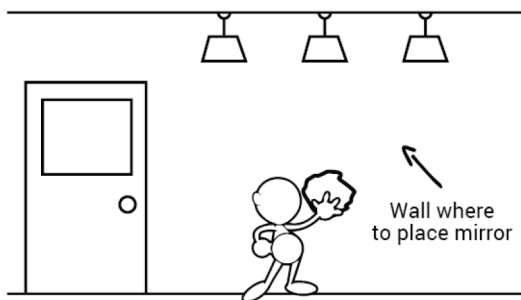

Clean the wall where you will be installing the mirror. Failure to do so may prevent the glue from curing properly and staying fastened in place.

⚠ Don't install a heavy mirror in a place where you feel the extra vibration.

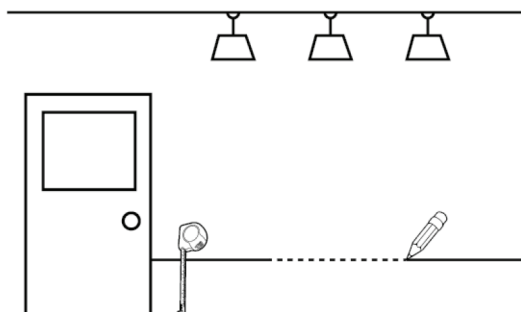

Determine where you want to place the mirror and then use a tape measure and pencil to draw a straight line from the floor for mirror positioning.

⚠ Freshly painted wall isn't ideal as that's layer hasn't been sealed yet.

5

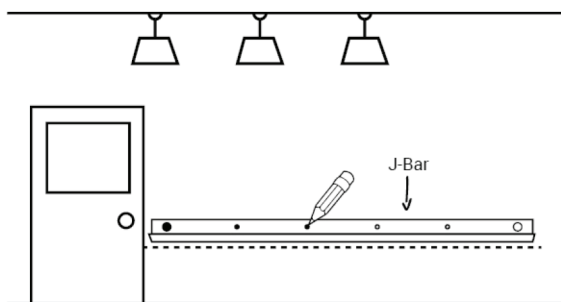

Hold the JBar in place on the wall just above the marks you just made. Use a level while you make four marks in a line with a pencil to show where to match them up with the holes in the JBar bottom support.

6

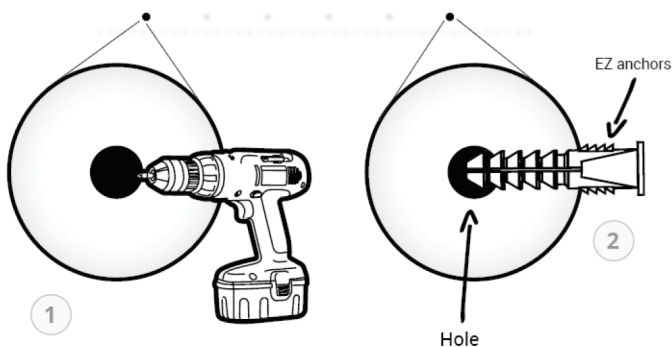

Drill four holes in the wall at the wall marks. Insert each of the 4 EZ anchors into the holes.

7

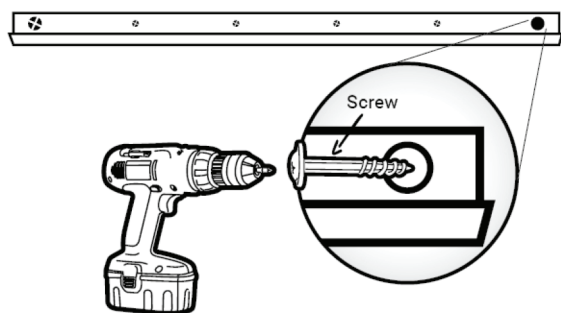

Move the JBar to line up its 4 holes with the 4 EZ anchors and hold it securely in place. Place four screws through the holes and drive them in.

⚠ Be careful while marking line ideally get someone else to hold the mirror or do the marking

8

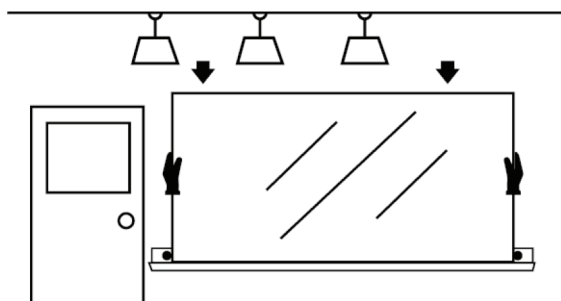

Pick up the mirror and slowly maneuver it into place inside the JBar.

9

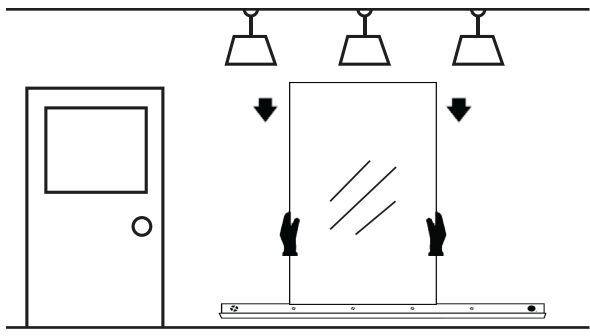

If you can hang a gym mirror vertically,

10

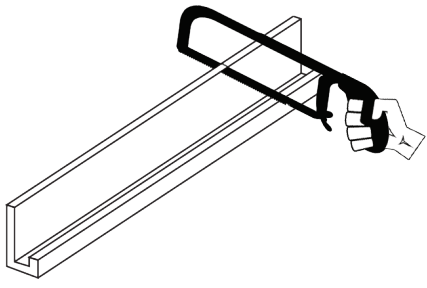

You need to cut the j-bar according to the width of the mirror when hanging it vertically so that the mirror can be fixed on the j-bar appropriately.

11

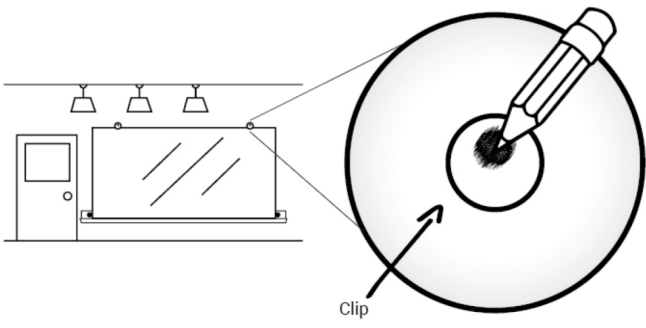

Position the round mirror clips and then draw two pencil marks, tracing each of the two mirror clips at the top of the mirror.

12

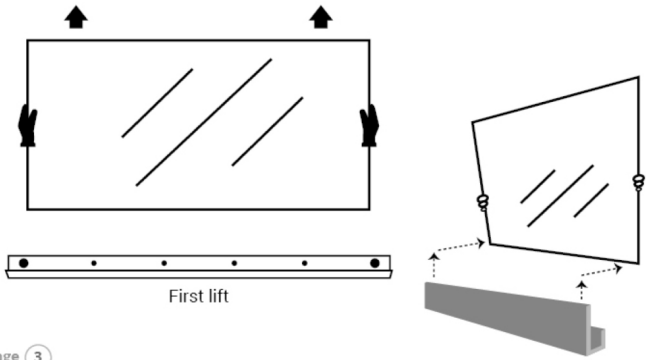

Slowly and cautiously pull the mirror from the JBar, lifting and then pulling it outward toward you.

13

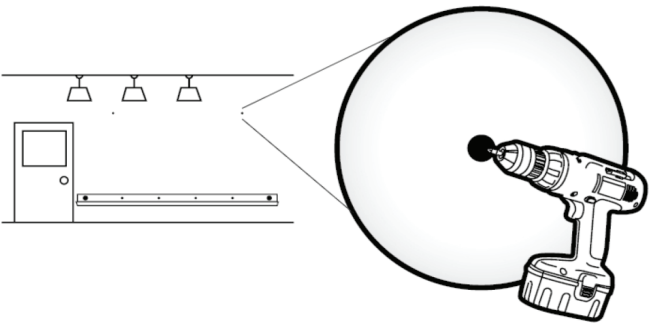

Drill holes in the pencil marks you made at the top of the mirror.

14

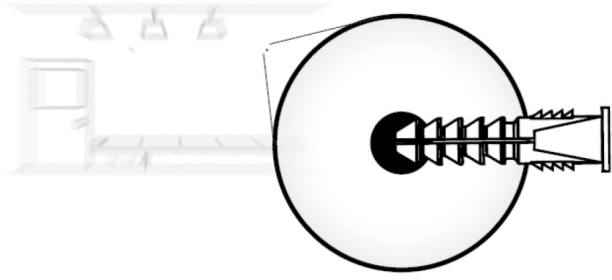

Insert plastic anchors into these two holes.

15

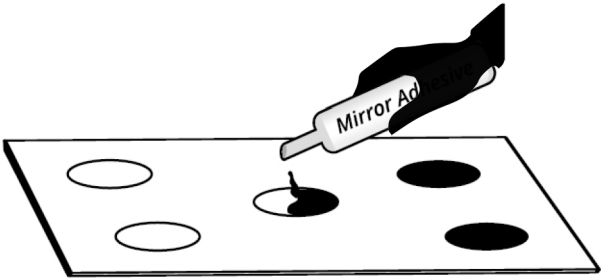

Spread mirror glue to create an area measuring 3/4-inch by 2/3-inch on the back of the mirror.

⚠ Don't forget to wear gloves before applying glue to the mirror. Apply adhesive in a straight line. Do not throw crisscross droplets that make sticking process weaker.

16

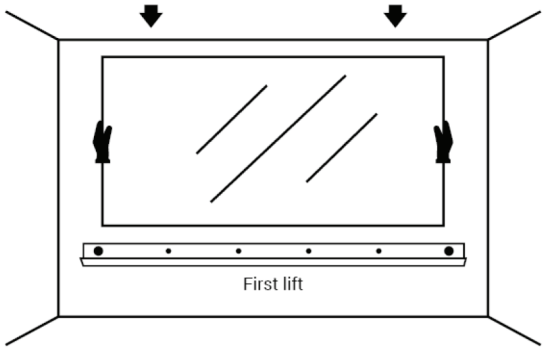

Carefully angle the mirror as you insert it into the JBar.

17

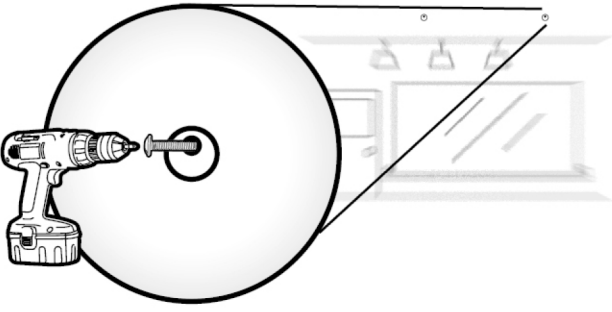

Screw the mirror clips into the two anchors you placed on the wall.

18

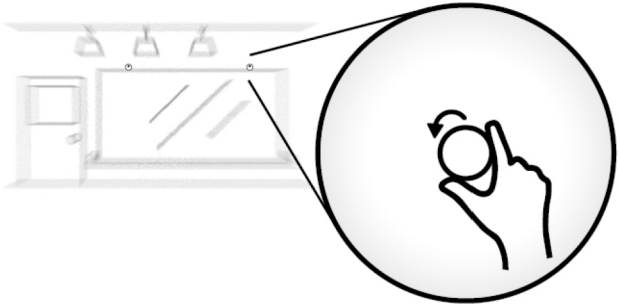

Fix the caps on the mirror clips.

⚠ Your mirror is now up on the wall but you're not quite done until you clean the installed mirror. Remove any leftover scum of any material like paint or glue that could harm once it gets dried.

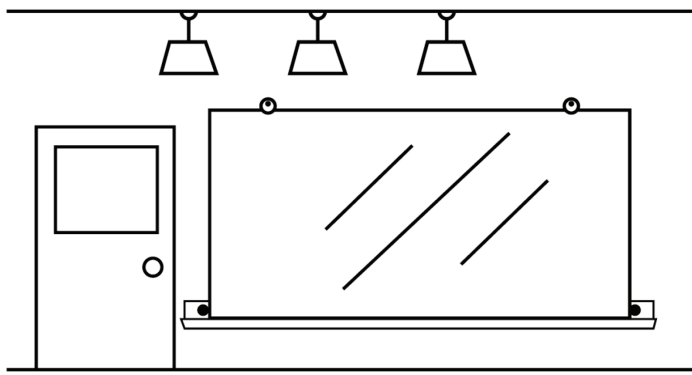

⚠ If someone inexperienced in cleaning mirror so one has to be very cautious.



Congratulations!
 You have finished installing
 your new Gym Mirror.