

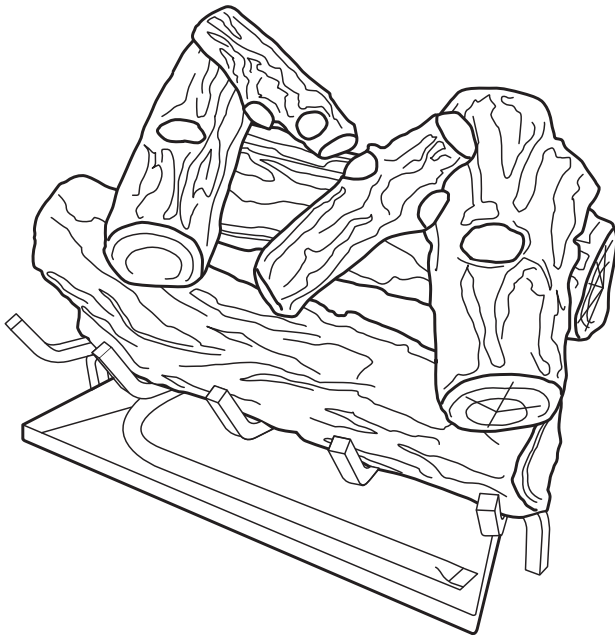

VENTED NATURAL GAS LOGS

MODELS

- VL-WO18D / VL-WO24D / VL-WO30D
- VL-AA18D / VL-AA24D / VL-AA30D
- VL-NO18D / VL-NO24D / VL-NO30D
- VL-SA18D / VL-SA24D / VL-SA30D
- VL-CA18D / VL-CA24D / VL-CA30D



0418GL012S

Complies with ANSI Z21.84-2012, Standard for Manually lighted, Natural Gas Decorative Gas Appliances for Installation in Solid-Fuel Burning Fireplaces.

Complies with ANSI Z21.60-2012, Standard for Decorative Gas Appliances for Installation in Solid-Fuel Burning Fireplaces when the LP Conversion Kit (SPK100) is installed by a qualified technician.

CAUTION - FOR YOUR SAFETY

WARNING: IF THE INFORMATION IN THIS MANUAL IS NOT FOLLOWED EXACTLY, A FIRE OR EXPLOSION MAY RESULT CAUSING PROPERTY DAMAGE, PERSONAL INJURY OR LOSS OF LIFE.

- Do not store or use gasoline or other flammable vapors and liquids in the vicinity of this or any other appliance.
- WHAT TO DO IF YOU SMELL GAS
 - Do not try to light any appliance.
 - Do not touch any electrical switch; do not use any phone in your building.
 - Immediately call your gas supplier from a neighbor's phone. Follow the gas supplier's instructions.
 - If you cannot reach your gas supplier, call the fire department.
- Installation and service must be performed by a qualified installer, service agency or the gas supplier.

This is a gas-fire appliance. It uses air (oxygen) from the room in which it is installed. Provisions for adequate combustion and ventilation air must be provided. Refer to Air For Combustion and Ventilation of page 7 of this manual.

INSTALLER: Leave this manual with the appliance.
CONSUMER: Retain this manual for future reference.

This appliance is convertible for use with propane/LP gas by using the MANUAL ON/OFF VALVE/SAFETY PILOT KIT (see ACCESSORIES on page 18).



Questions, problems, missing parts? Before returning to your retailer, call our customer service department at 1-877-447-4768, 8:30 a.m. – 4:30 p.m., CST, Monday – Friday or email us at customerservice@ghpgroupinc.com.

TABLE OF CONTENTS

Specifications	2
Important Safety Information	3
Product Identification	5
Product Features	6
Unpacking.....	6
Preparing for Installation.....	7
Installation	8
Assembling Logs	12
Operation.....	15
Care and Maintenance	17
Accessories	18
Troubleshooting	19
Replacement Parts	21
Warranty	23

SPECIFICATIONS

Note: *This vented appliance must be installed only in a solid-fuel burning fireplace with a working flue and constructed of noncombustible material.*

The charts indicate technical information regarding the installation of your gas log set.

Please make sure that all of the specifications shown are applicable before installation is attempted.

The fireplace must include a working flue and venting system with the minimum openings shown as below.

ITEM	VL-WO18D	VL-WO24D	VL-WO30D
	VL-AA18D	VL-AA24D	VL-AA30D
	VL-NO18D	VL-NO24D	VL-NO30D
	VL-SA18D	VL-SA24D	VL-SA30D
	VL-CA18D	VL-CA24D	VL-CA30D
Input Rating (BTU/Hr)	45,000	55,000	65,000
Gas Type	NG	NG	NG
Ignition Type	Match	Match	Match
Max. Inlet Pressure	7" WC	7" WC	7" WC
Min. Inlet Pressure	5.5" WC	5.5" WC	5.5" WC
Normal Pressure	7" WC	7" WC	7" WC
(For Purpose of Input Adjustment)			
Minimum Vent Opening	8" Diameter	8" Diameter	8" Diameter

Log Size	Minimum Firebox Size			
	Height	Depth	Front Width	Rear Width
18 in. Vented	19"	15"	24"*	20"
24 in. Vented	19"	15"	30"*	26"
30 in. Vented	20"	15"	36"*	32"

*Important: If adding a Liquid Propane Conversion Safety Pilot Kit to the burner, 8" needs to be added to the front width dimension.

SAFETY INFORMATION

IMPORTANT: Read this owner's manual carefully and completely before trying to assemble, operate, or service this log set. Improper use of this log set can cause serious injury or death from burns, fire, explosion, electrical shock, and carbon monoxide poisoning.

Only a qualified installer, service agent, or local gas supplier may install and service this product.

WARNING: Do not store or use gasoline or other flammable vapors or liquids in the vicinity of this or any other appliance.

WARNING: The log set is shipped from the factory adjusted for natural gas use only. Liquid Propane can only be used after installation of Liquid Propane Conversion Safety Pilot Kit.

CARBON MONOXIDE POISONING: Early signs of carbon monoxide poisoning resemble the flu with headaches, dizziness, or nausea. If you have these signs, the log set may not be working properly. Get fresh air immediately! Have log set serviced. Some people are more affected by carbon monoxide than others. These include pregnant women, people with heart or lung disease, people who are anemic, those under the influence of alcohol, and those living in high altitudes.

NATURAL AND PROPANE/LP GAS: Natural and Propane/LP gases are odorless. An odor-making agent is added to the gas. The odor helps you detect a gas leak. However, the odor added to the gas can fade. Gas may be present even though no odor exists. Make certain you read and understand all warnings. Keep this manual for reference. It is your guide to operating this log set safely.

WARNING:

- Due to high temperatures, locate this appliance out of traffic and away from furniture and draperies.
- Log set becomes very hot when operating. Keep children and adults away from hot surfaces to avoid burns or clothing ignition. Log set will remain hot for a time after shut-off. Allow surfaces to cool before touching.
- Carefully supervise young children when they are in the room with the log set.
- Do not place clothing or other flammable material on or near the appliance. Never place any objects in the log set.
- Installation and repair should be done by a qualified service person. The appliance should be inspected before use and at least annually by a professional service person. More frequent cleaning may be required due to excessive lint from carpeting, bedding material, etc. It is imperative that control compartments, burners and circulating air passageways of the appliance be kept clean.
- Any change to this log set or its controls can be dangerous.
- DO NOT OPERATE THIS GAS LOG SET WITH GLASS DOORS CLOSED.
- Do not use any accessories not approved for use with this log set.
- Keep the appliance area clear and free from combustible materials, gasoline, and other flammable vapors and liquids.

WARNING

This product and the fuels used to operate this product (liquid propane or natural gas), and the products of combustion of such fuels, can expose you to chemicals including benzene, which is known to the State of California to cause cancer and reproductive harm.

For more information go to www.p65Warnings.ca.gov

SAFETY INFORMATION

1. This appliance is only for use with the type of gas indicated on the rating plate.
2. Do not place propane/LP supply tank(s) inside any structure. Locate propane/LP supply tank(s) outdoors.
3. If you smell gas
 - shut off gas supply
 - do not try to light any appliance
 - do not touch any electrical switch; do not use any phone in your building
 - immediately call your gas supplier from a neighbor's phone. Follow the gas supplier's instructions
 - if you cannot reach your gas supplier, call the fire department
4. This log set shall not be installed in a bedroom or bathroom.
5. Do not use this log set as a wood-burning log set. Use only the logs provided with the log set.
6. Do not add extra logs or ornaments such as pine cones, vermiculite or rock wool. Using these added items can cause sooting.
7. This log set is designed to be smokeless. If logs ever appear to smoke, turn off log set and call a qualified service person. Note: During initial operation, slight smoking could occur due to log curing and log set burning manufacturing residues.
8. To prevent the creation of soot, follow the instructions in Cleaning and Maintenance, page 17-18.
9. Before using furniture polish, wax, carpet cleaner or similar products, turn log set off. If heated, the vapors from these products may create a white powder residue within burner box or on adjacent walls or furniture.
10. This log set needs fresh air ventilation to run properly.
11. Do not run log set
 - where flammable liquids or vapors are used or stored.
 - under dusty conditions.
12. Do not use this log set to cook food or burn paper or other objects.
13. Never place any objects in the fireplace or the logs.
14. Do not use log set if any part has been under water. Immediately call a qualified service technician to inspect the log set and to replace any part of the control system and any gas control which has been under water.
15. Turn off and unplug log set and let cool before servicing. Only a qualified service person should service and repair log set.

QUALIFIED INSTALLING AGENCY

Only a qualified agency should install and replace gas piping, gas utilization equipment or accessories, and repair and equipment servicing. The term "qualified agency" means any individual, firm, corporation, or company that either in person or through a representative is engaged in and is responsible for:

- a) Installing, testing, or replacing gas piping or
- b) Connecting, installing, testing, repairing, or servicing equipment; that is experienced in such work; that is familiar with all precautions required; and that has complied with all the requirements of the authority having jurisdiction.

PRODUCT IDENTIFICATION

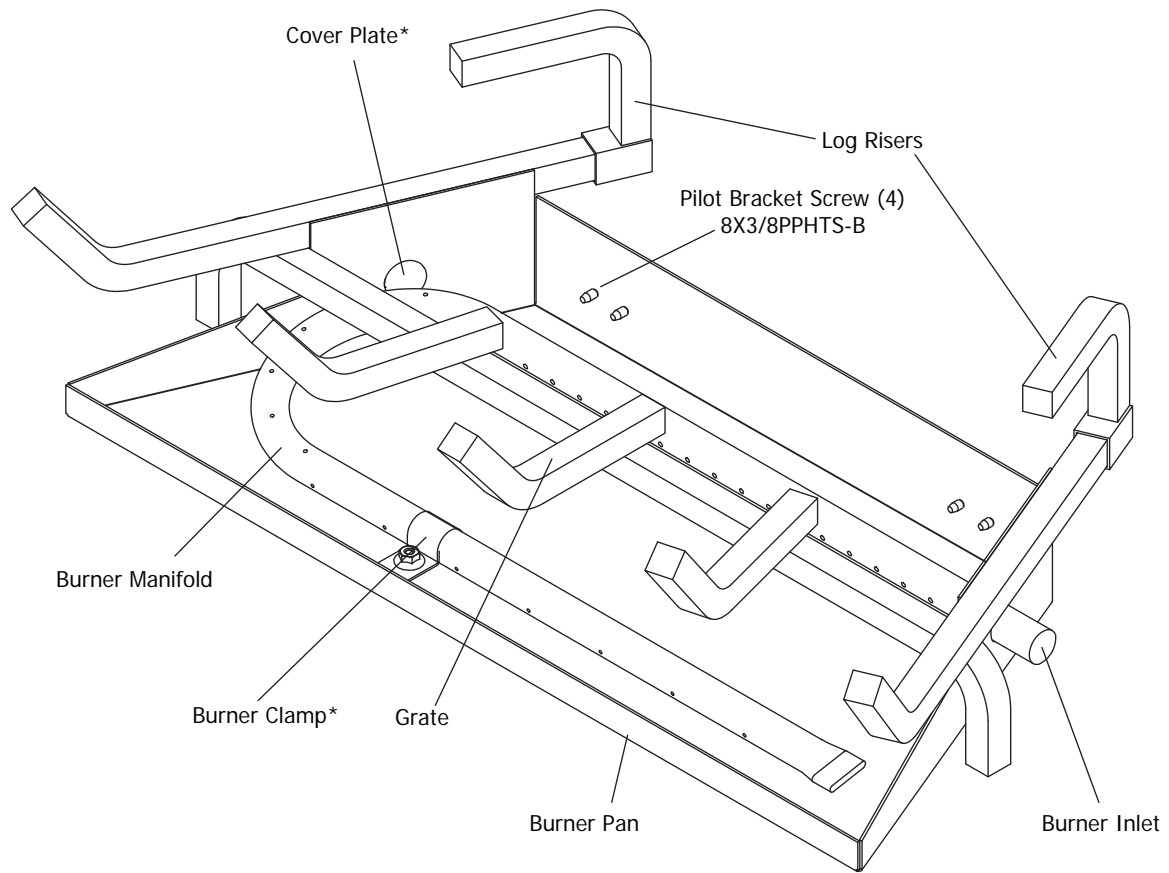

*Uses (4) 8X3/8PPHTS-B Screws

PRODUCT FEATURES

The State of Massachusetts requires that the chimney flue damper, when used with decorative gas log sets, be welded open or completely removed. In the State of Massachusetts, this appliance must be installed by a licensed plumber or gasfitter.

In the State of Massachusetts the gas cock must be a T-handle type. The State of Massachusetts requires that a flexible appliance connector cannot exceed three feet in length.

LOCAL CODES

Install and use log set with care. Follow all codes. In the absence of local codes, use the latest edition of The National Fuel Gas Code, ANSI Z223.1, also known as NFPA 54*.

*Available from:

American National Standard Institute, Inc.
1430 Broadway
New York, NY 10018

National Fire Protection Association, Inc.
1 Batterymarch Park
Quincy, MA 02269-9101

UNPACKING

CAUTION: Do not remove the metal data plates from the burner pan. The data plates contain important product information.

1. Remove logs, pan materials, and hardware from carton.
2. Remove all protective packaging applied to logs and base for shipment.
3. Check all items for any shipping damage. If damaged, promptly inform GHP Group, Inc. at 1-877-447-4768.

Fig. 1

For Masonry Built
Fireplaces Free Opening
Area Of Chimney Damper

	Log Set Size		
	18"	24"	30"
Chimney Height* (ft)	Minimum Opening** (sq. in.)		
6	41.7	49.2	56.6
8	38.7	45.5	52.4
10	35.2	41.7	48.2
15	32.0	37.7	43.2
20	28.8	34.3	39.8
30	26.5	31.2	35.9

* Height is from hearth to top of chimney and the minimum height is 6 feet.

** Chart shows minimum opening (sq. in.) for a given height and input rate.

For Factory Built
Fireplaces Free Opening
Area Of Chimney Damper

	Log Set Size		
	18"	24"	30"
Chimney Height* (ft)	Minimum Opening** (sq. in.)		
10	28.3	35.3	44.2
15	21.2	26.4	32.2
20	18.1	22.1	26.4
25	15.9	18.1	22.1
30	14.5	17.3	20.4
35	13.2	15.9	18.9
40	12.6	15.2	18.1

* Height is from hearth to top of chimney and the minimum height is 10 feet.

** Chart shows minimum opening (sq. in.) for a given height and input rate.

ASSEMBLING LOGS

VL-WO18D/VL-WO24D/VL-WO30D/VL-SA18D/VL-SA24D/VL-SA30D

⚠ WARNING: Failure to position the parts in accordance with these diagrams or failure to use only parts specifically approved with this log set may result in property damage or personal injury.

⚠ CAUTION: After installation and periodically thereafter, check to ensure that no yellow flame comes in contact with any log. With the log set set to High, check to see if yellow flames contact any log. If so, reposition logs according to the log installation instructions in this manual. Yellow flames contacting logs will create soot.

It is very important to install the logs exactly as instructed. Do not modify logs; use only logs supplied with log set. Each log is marked with a number, and this number will help you identify each log during installation.

NOTE: These log installation instructions are recommended to decrease the amount of sooting the most.

Provided Logs: 6

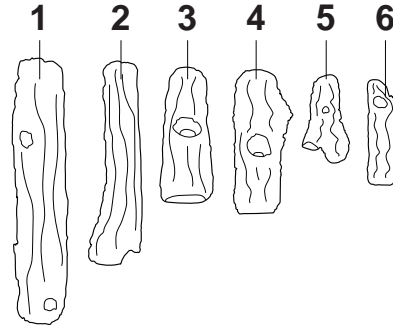
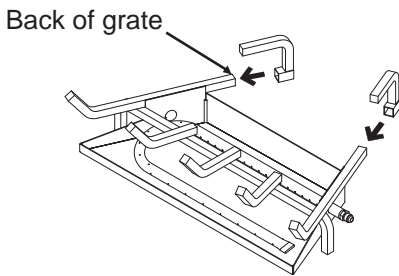
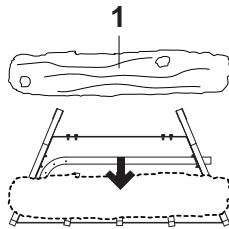

Fig. 9 - Installing Risers



1. After optional accessories are installed (see previous page), slide both risers onto the back of the grate. Make sure the back of the grate is flush with the back of the riser.

Fig. 10 - Installing Log #1



2. Place log #1 on the top of the front grate and make sure the log is centered in the grate.

Fig. 11 - Installing Log #2

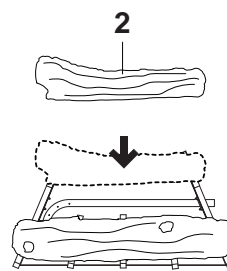

3. Carefully place log #2 on the top of the risers. Make sure the log is centered on top of the risers.

Fig. 12 - Installing Log #3

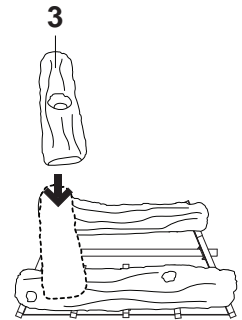

3. Place log #3 so it is resting on the top left of logs #1 and #2.

Fig. 13 - Installing Log #4

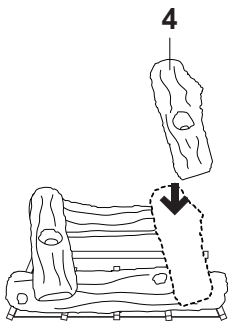

4. Place log #4 so it is resting on the top right of logs #1 and #2.

Fig. 14 - Installing Log #5

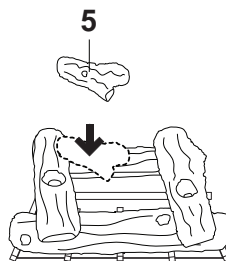

5. Place log #5 so it is resting on logs #3 and #2 only.

Fig. 15 - Installing Log #6

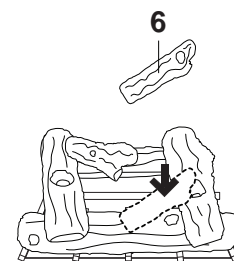

6. Place log #6 so that it is resting on logs #1 and #4.

ASSEMBLING LOGS

VL-AA18D/VL-NO18D/VL-CA18D

⚠ WARNING: Failure to position the parts in accordance with these diagrams or failure to use only parts specifically approved with this log set may result in property damage or personal injury.

⚠ CAUTION: After installation and periodically thereafter, check to ensure that no yellow flame comes in contact with any log. With the log set set to High, check to see if yellow flames contact any log. If so, reposition logs according to the log installation instructions in this manual. Yellow flames contacting logs will create soot.

Provided Logs: 7

It is very important to install the logs exactly as instructed. Do not modify logs; use only logs supplied with log set. Each log is marked with a number, and this number will help you identify each log during installation.

NOTE: These log installation instructions are recommended to decrease the amount of sooting the most.

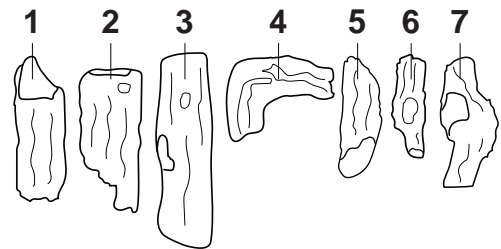
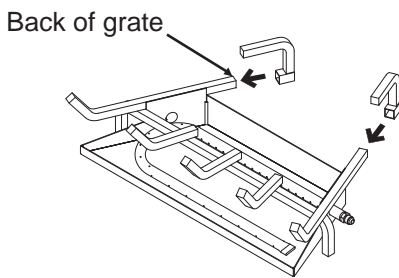
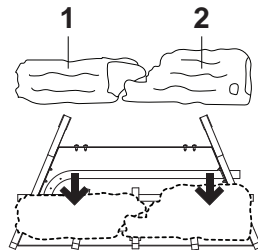

Fig. 16 - Installing Risers



1. After optional accessories are installed (see page 11), slide both risers onto the back of the grate. Make sure the back of the grate is flush with the back of the riser.

Fig. 17 - Installing Logs #1-2



2. Place logs #1 and #2 on the top of the front grate and make sure the break in between the two logs is centered on the grate and the logs are touching.

Fig. 18 - Installing Log #3

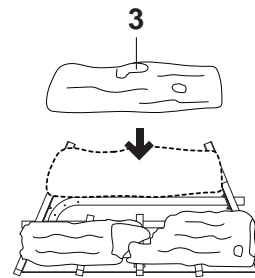

3. Carefully place log #3 on the top of the risers. Make sure the log is centered on top of the risers.

Fig. 19 - Installing Log #4

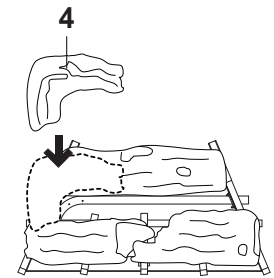

3. Place log #4 so it is resting on the top left of logs #1 and #3. The long side should be resting on log #3.

Fig. 20 - Installing Log #5

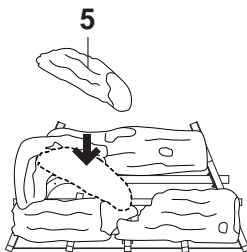

4. Place log #5 so it is resting on the back of log #4 and somewhere on the break of logs #1 and #2.

Fig. 21 - Installing Log #6

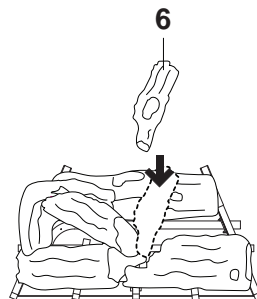

5. Place log #6 so it is resting on logs #3 and #5 only.

Fig. 22 - Installing Log #7

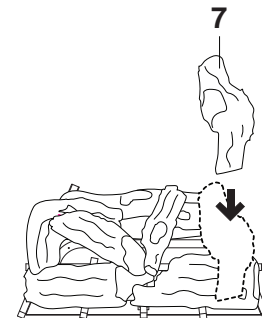

6. Place log #7 so that it is resting on logs #2 and #3.

ASSEMBLING LOGS

VL-AA24D/VL-AA30D/VL-NO24D/VL-NO30D/VL-CA24D/VL-CA30D

⚠ WARNING: Failure to position the parts in accordance with these diagrams or failure to use only parts specifically approved with this log set may result in property damage or personal injury.

⚠ CAUTION: After installation and periodically thereafter, check to ensure that no yellow flame comes in contact with any log. With the log set set to High, check to see if yellow flames contact any log. If so, reposition logs according to the log installation instructions in this manual. Yellow flames contacting logs will create soot.

It is very important to install the logs exactly as instructed. Do not modify logs; use only logs supplied with log set. Each log is marked with a number, and this number will help you identify each log during installation.

NOTE: These log installation instructions are recommended to decrease the amount of sooting the most.

Provided Logs: 7

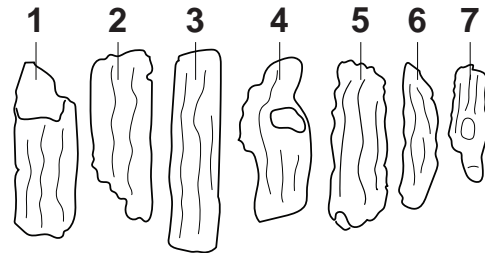
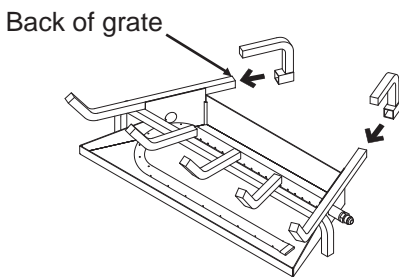
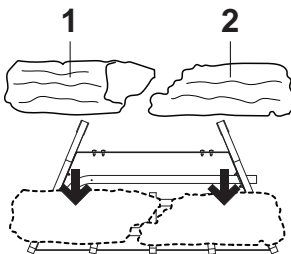

Fig. 23 - Installing Risers



1. After optional accessories are installed (see page 11), slide both risers onto the back of the grate. Make sure the back of the grate is flush with the back of the riser.

Fig. 24 - Installing Logs #1-#2



2. Place log #1 and #2 on the top of the front grate and make sure the break between the two logs is centered on the grate and the logs are touching.

Fig. 25 - Installing Log #3

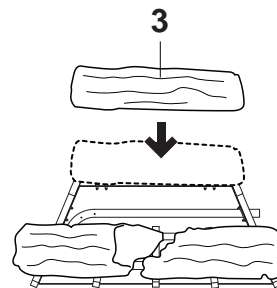

3. Carefully place log #3 on the top of the risers. Make sure the log is centered on top of the risers.

Fig. 26 - Installing Log #4

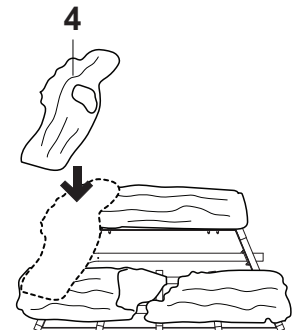

3. Place log #4 so it is resting on the top left of logs #1 and #3.

Fig. 27 - Installing Log #5

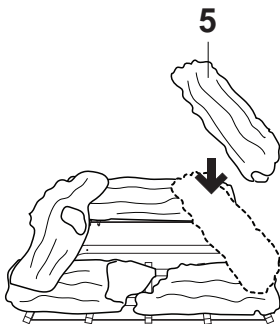

4. Place log #5 so it is resting on the top right of logs #2 and #3.

Fig. 28 - Installing Log #6

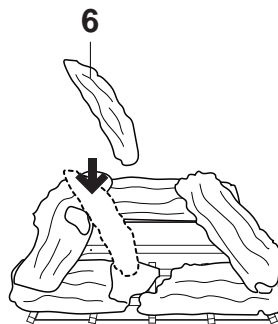

5. Place log #6 so it is resting on log #4 and somewhere on the break of logs #1 and #2.

Fig. 29 - Installing Log #7

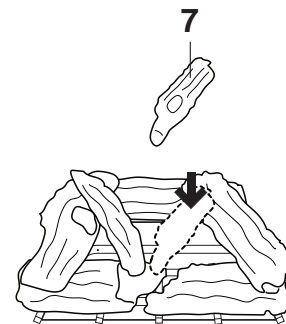

6. Place log #7 so that it is resting on logs #1 and #5.