

USE AND CARE GUIDE

52-INCH CRYSTAL CEILING FAN

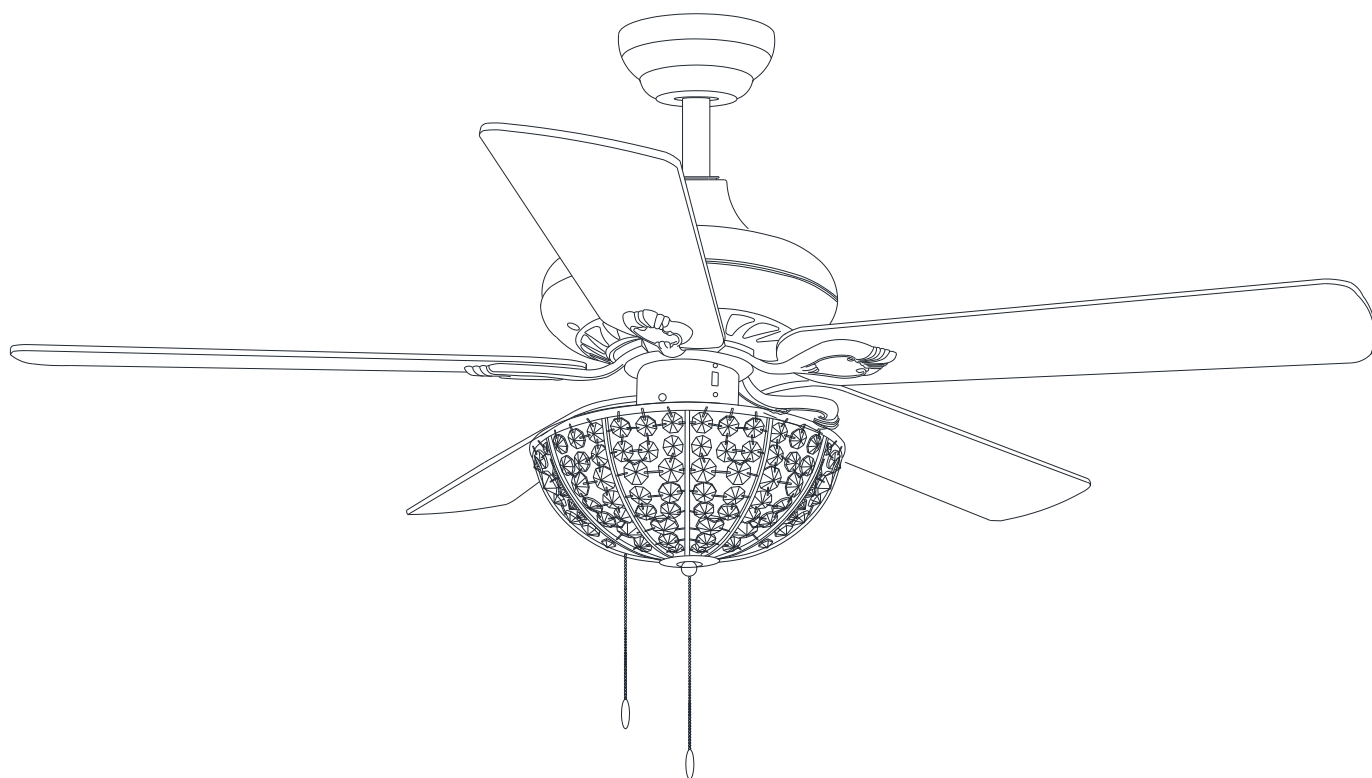

Table of Contents

Safety Information	2	Attaching the Fan Blades	7
Pre-Installation	3	Attaching the Lights	8
Hardware included	4	Install the crystal shade	9
Ceiling	5	Use of remote control	10
Hanging the Fan	6	Care and cleaning	11

Safety Information

1. To reduce the risk of electrical shock the electricity has been turned off at the circuit breaker or fuse box before begin.
2. All wiring must be in accordance with the National Electrical Code NASI/NFPA 70 -1999 and local electrical codes. Electrical installation should be performed by a qualified licensed electrician .
3. The outlet box and support structure must be securely mounted and capable of reliably supporting 35lb.(15.9kg).Use only UL listed outlet boxes marked "Acceptable for Fan Support of 35lbs(15.9kg)or less."
4. The fan must be mounted with a minimum of 7 ft. (2m) clearance from the trailing edge of the blades to the floor.
5. Do not operate the reversing switch while the fan blades are in motion. You must turn the fan off and stop the blades before you reverse the blade direction.
6. Do not place objects in the path of the blades.
7. To avoid personal injury or damage to the fan and other items use caution when working around or cleaning the fan.
8. Electrical diagrams are for reference only. Light kits that are not packed with the fan must be UL-listed and marked suitable for use with the model fan you are installing. Switches must be UL General Use Switches. Refer to the instructions packaged with the light kits and switches for proper assembly.
9. After making electrical connections , spliced conductors should be turned upward and pushed carefully up into the outlet box.The wires should be spread apart with the grounded conductor and the equipment-grounding conductor on one side of the outlet box.
10. All setscrews must be checked and retightened where necessary before installation.



WARNING:TO reduce the risk of personal injury, do not bend the blade brackets (also referred to as flanges) during assembly or after installation.Do not insert objects in the path of the blades .



WARNING: Remove the rubber motor stops on the bottom of the fan before installing the blades or testing the motor.



WARNING: To reduce the risk of fire or electric shock,do not use this fan with any solid-state speed control device.



WARNING:To avoid possible electrical shock, turn the electricity off at the main fuse box before wiring.It you feel you do not have enough electrical wiring knowledge or experience, contact a licensed electrician.



WARNING: Electrical diagrams are for reference only. Optional use of any light kit shall be UL-listed and marked suitable for use with this fan.



WARNING: To reduce the risk of fire, electric shock, or personal injury. mount to outlet box marked " Acceptable for fan support of 35 lbs.(15.9 kg)or less." and use the screws provided with the outlet box.

Warranty

The supplier warrants the fan motor to be free from defects in workmanship and material present at time of shipment from the factory for a lifetime after the date of purchase by the original purchaser. The supplier also warrants that all other fan parts, excluding any glass or acrylic blades, to be free from defects in workmanship and material at the time of shipment from the factory for a period of one year after the date of purchase by the original purchaser. We agree to correct such defects without charge or at our option replace with a comparable or superior model if the product is returned. To obtain warranty service, you must present a copy of the receipt s proof of purchase. All costs of removing and reinstalling the product are your responsibility. Damage to any part, such as by accident, misuse, improper installation or by affixing any accessories, is not covered by this warranty. Because of varying climatic conditions this warranty does not cover any changes in brass finish, including rusting, pitting, corroding, tarnishing, or peeling. Brass finish of this type give their longest useful life when protected from varying weather conditions. A certain amount of "wobble" is normal and should not be considered a defect. Servicing performed by unauthorized persons shall render the warranty invalid. There is no other express warranty. hereby disclaims any and all warranties, including but not limited to those of merchantability and fitness for a particular purpose to the extent permitted by law. The duration of any implied warranty which cannot be disclaimed is limited to the time period as specified in the express warranty. Some states do not allow a limitation on how long an implied warranty lasts, so the above limitation may not apply to you. The retailer shall not be liable for incidental, consequential, or special damages arising out of or in connection with product use or performance except as may otherwise be accorded by law. Some states do not allow the exclusion of incidental or consequential damages, so the above exclusion or limitation may not apply to you. This warranty gives specific legal rights, and you may also have other rights which vary from state to state. This warranty supersedes all prior warranties. Shipping costs for any return of products as part of a claim on the warranty must be paid by the customer.

Pre-Installation

SPECIFICATION

Size	Speed	Volts	Amps	Watts	RPM	CFM	Net Weight	Gross Weight	Cube Feet
52 in	Low	120	0.21	11	65	990	17.3lb (7.85KG)	20.83lb (9.45KG)	2.82cu.ft.
	Medium		0.35	30	116	3596			
	High		0.48	58	166	5146			

The above data are for reference only, Actually the motor speed of each ceiling fan is a little different. Any products, Subject to actual products as standard.



NOTE: These are approximate measures. They do not include the amps and wattage used by the light kit.

Specifications & measurements shown are subject to $\pm 5\%$ variations.

TOOLS REQUIRED



Phillips screwdriver



Flat blade screwdriver

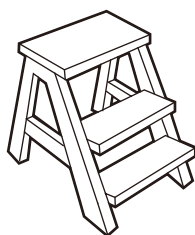

Step ladder



Wire stripper



Electrical tape

Pre-Installation(continued)

HARDWARE INCLUDED



NOTE: Hardware not shown to actual size.

components table

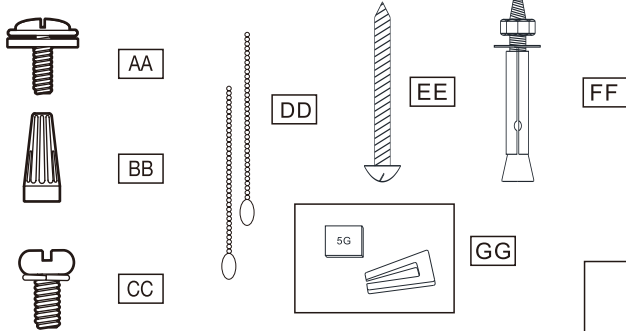

AA	Blade attachment screw and fiber washer	16
BB	Plastic wire nut (not to scale)	3
CC	Blade arm screw and lock washer	1
DD	Pull chain and fob (not to scale) < hand pull chain only >	2
EE	Mounting screws	4
FF	Expansion Bolts	2
GG	Balanced parts package	1

PACKAGE CONTENTS

		remote control<ONLY>		
K	Remote control (Transmitter)	1	L Remote control (receiver)	1

A	Fan-motor assembly	1	B	Arm (with pre-installed screws)	5
		C		Light kit fitter assembly	1

E	Blade
5	

F	Slide-on mounting bracket (inside canopy)	1	G	13CM Ball/downrod assembly	1			
H	Canopy	1	I	25CM Ball/downrod assembly	1	J	Coupling cover	1

Installation of the hanging bracket (suspension part)

Wooden ceiling

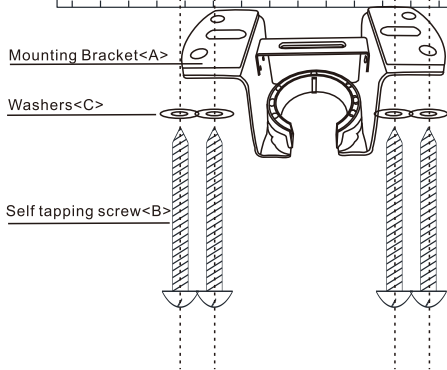

For wooden ceiling, use wood screw to drill on the wooden beam or the "junction box" to fix the hanging bracket (selection is made according to actual requirements of the customers).

STEP 1A-WOODEN CEILING

SWITCH OFF THE ELECTRICAL MAINS AT THE CIRCUIT BREAKER FUSE BOX.

- 1) Use the Mounting Bracket (A) as a guide, mark the spots where the 4 Self Tapping Screws (B) will be drilled.
- 2) Remove the Mounting Bracket (A), drill 4 holes for 3MM diameter, install the mounting bracket onto wooden ceiling with the 4 Self Tapping Screws (B) & Washers (C).

⚠ IMPORTANT : SCREWS MUST BE TIGHTENED TILL SNUG

CONCRETE CEILING

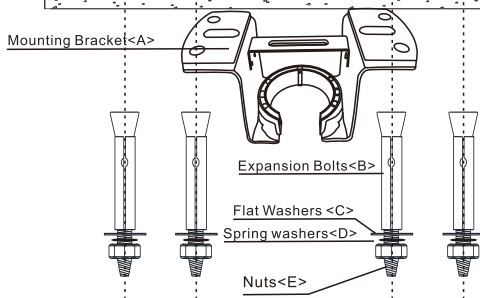

⚠ Note: According to the ceiling of different materials, use different screws to fix the hanging bracket. Don't fix the hanging bracket on the wood ceiling less than 12MM to prevent danger caused by loosening of screws. After the hanging bracket is completed, ensure that it can withstand the tension test of more than 68KG for safety.

For concrete ceiling, use the percussion bit with diameter 8mm to drill holes according to the length of expansion screws. Then use the attached expansion screws to fix the hanging bracket onto the ceiling (selection is made according to actual requirements of the customers).

STEP 2A - CONCRETE CEILING

SWITCH OFF THE ELECTRICAL MAINS AT THE CIRCUIT BREAKER FUSE BOX.

- 1) Use the Mounting Bracket (A) as a guide, mark the spots where the 4 Expansion Bolts (B) will be drilled.
- 2) Remove the Mounting Bracket (A), drill 4 holes and insert 4 Expansion Bolts (2) into the concrete ceiling, install the mounting bracket and secure with Flat Washers (C), Spring Washers (D) and Nuts (E).

⚠ IMPORTANT : SCREWS & NUTS MUST BE TIGHTENED TILL SNUG

Install the hanging part of the ceiling fan.

1. install downrod assembly

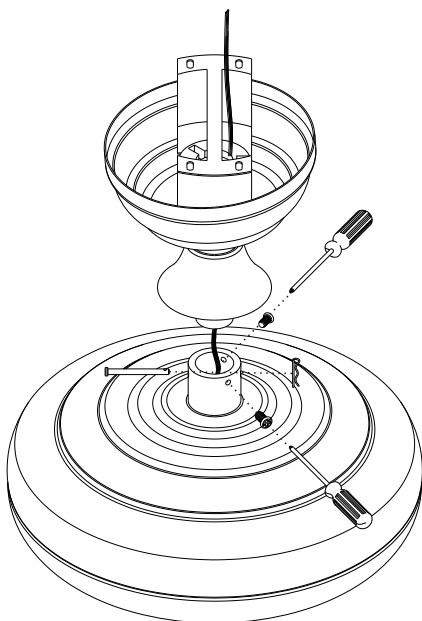

1. Thread the suspender through the suspended clock and coupling cover .
2. Then insert the tail of the suspender from the lifting head of the motor.
3. After the lateral pin is threaded out from the suspended head position, insert R type pin.
4. Tighten the lifting head screws.
5. Hang the fan of the hanging pipe into the hanger.

Assembly – Hanging the Fan(continued)

1. Making the electrical connections



WARNING: Each wire not supplied with this fans is designed to accept up to one 12-gauge house wire and two wires from the fan. If you have larger than 12-gauge house wiring or more than one house wire to connect to the fan wiring, consult an electrician for the proper size wire nuts to use.



WARNING: Remove the rubber motor stops on the bottom of fan before installing the blades or testing the motor.



IMPORTANT: Use the plastic wire connectors(BB) supplied with your fan. Secure the connectors with electrical tape and ensure there are no loose strands or connections.



NOTE: The fan comes with 54in. Lead wires for use with an extended ball/downrod assembly. If using the 4.5in. ball/downrod assembly(B) provided you can cut the lead wires to your desired length(no sooner than 12in.).

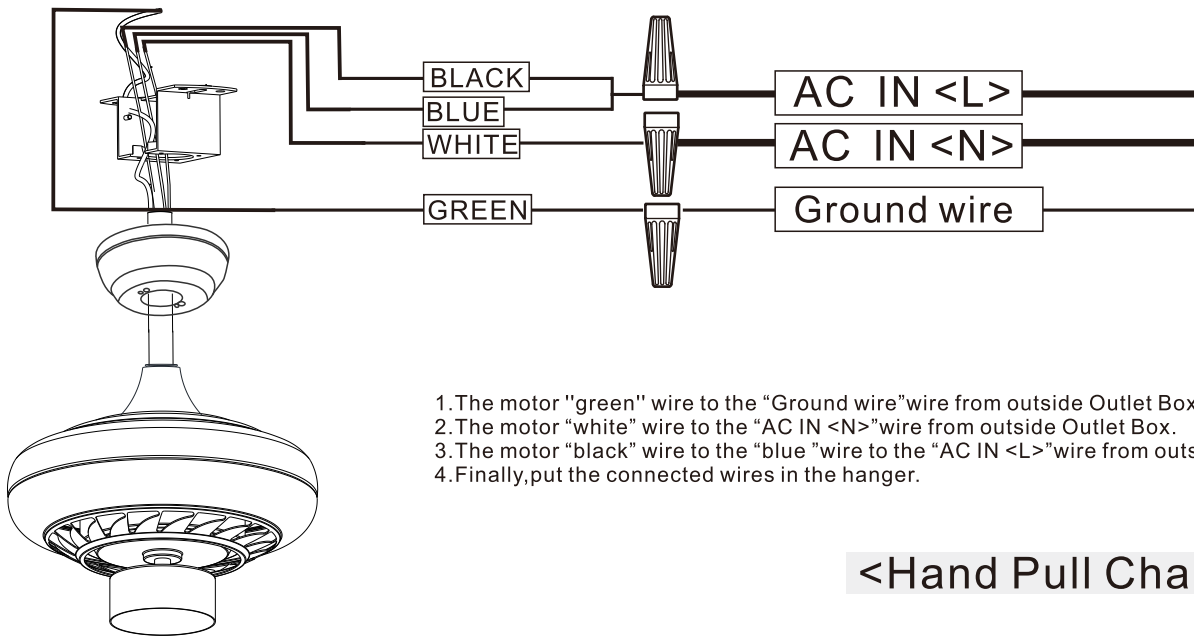

1. The motor "green" wire to the "Ground wire" wire from outside Outlet Box.
2. The motor "white" wire to the "AC IN <N>" wire from outside Outlet Box.
3. The motor "black" wire to the "blue "wire to the "AC IN <L>" wire from outside Outlet Box.
4. Finally, put the connected wires in the hanger.

<Hand Pull Chain ONLY>

Assembly – Hanging the Fan(continued)

Preparing for mounting

<Hand Pull Chain ONLY>

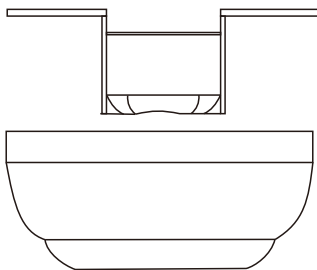

⊕
Phillips
screwdriver

- 1: Remove the mounting bracket from the canopy by loosening the two canopy screws located in the L shaped slots.
- 2: Remove and save the two canopy screws in the round holes. This will enable you to remove the mounting bracket

Install remote control

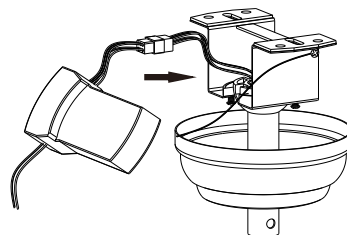

1. Carefully push the canopy to the bottom of the mounting bracket, make two sliding holes aligned to the two prominent screws on the mounting bracket, and then turn clockwise until tight.
2. Push the canopy ring to the bottom of the canopy, slide the inner holes aligned to the two prominent screws on the mounting bracket again, and turn the canopy ring clockwise until tight.

remote control <ONLY>

Preparing for mounting

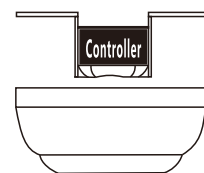

- 1: Remove the mounting bracket from the canopy by loosening the two canopy screws located in the L shaped slots.
- 2: Remove and save the two canopy screws in the round holes. This will enable you to remove the mounting bracket

Assembly – Attaching the Fan Blades

1. Attaching the blades to the arms

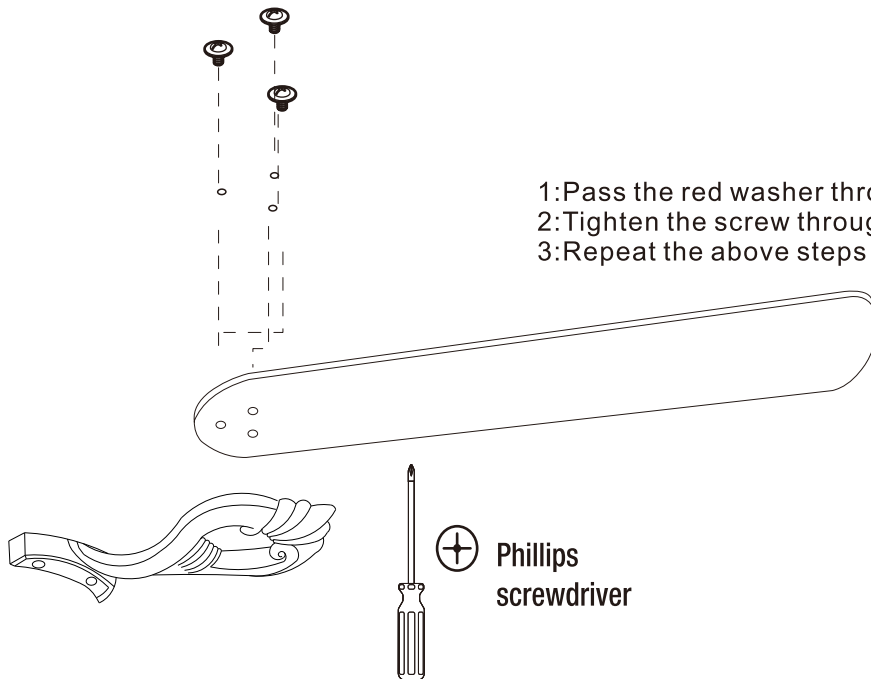

Assembly – Attaching the Fan Blades

2. Fastening the blade arms to the motor



NOTE: Your fan features revolutionary advancements for quick and easy blade installation. Including an alignment post and captive blade arm screws.



WARNING: Remove the rubber motor stops on the bottom of the fan before installing the blades or testing the motor.



NOTE: Your fan blades are reversible. Select the blade side finish which best accentuates your decor.

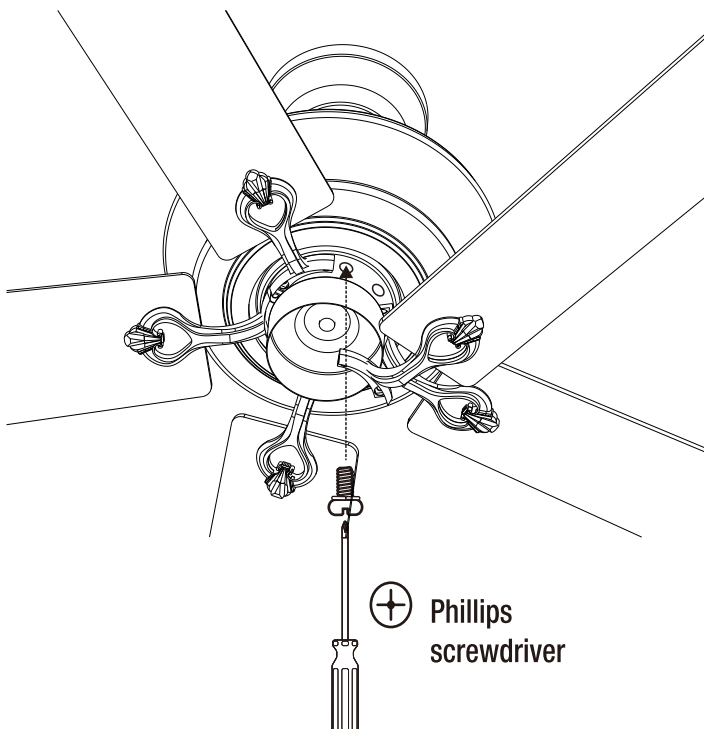

- 1: Fasten the arm to the fan-motor assembly by inserting the alignment post into the slot on the bottom of the motor and tightening the pre-installed arm screws.
- 2: Repeat this step for the remaining blade assemblies.

Assembly – Attaching the Lights

1. Connecting lamp wire



CAUTION: To reduce the risk of electric shock, disconnect the electrical circuit to the fan before installing the light fixture.

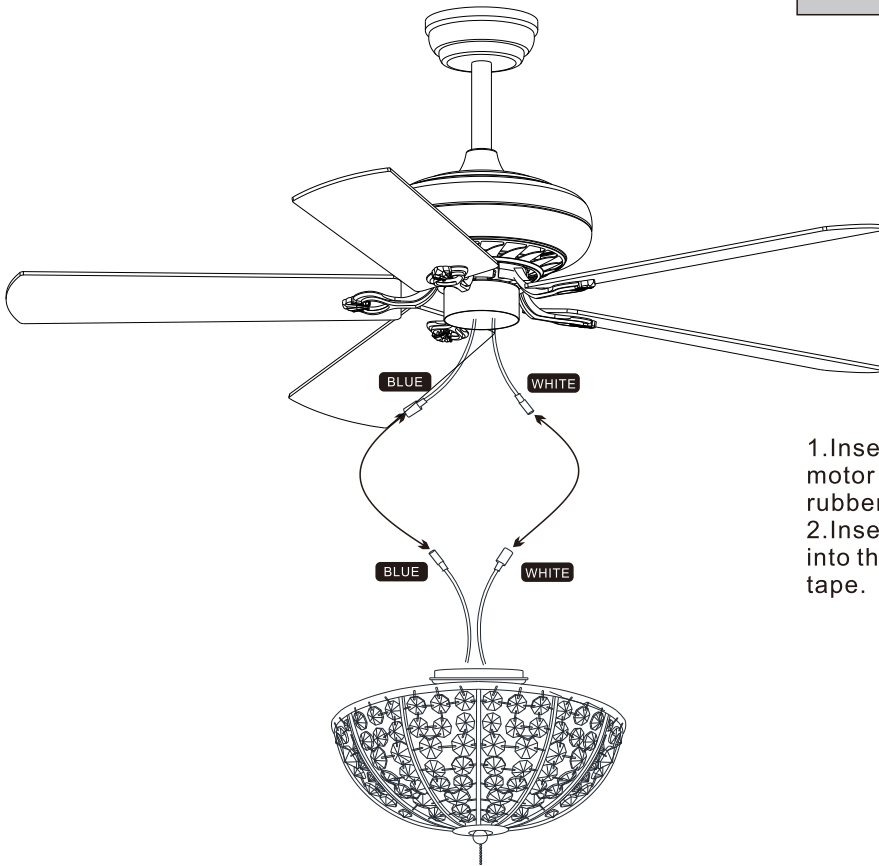

1. Insert the “white” line in the switching box of the motor into the “white” line of the light and tie insulated rubber tape.
2. Insert the “blue” line in the switching box of the motor into the “blue” line of the light and tie insulated rubber tape.

Assembly – Attaching the Lights

2. Tighten the screw of the box cover.

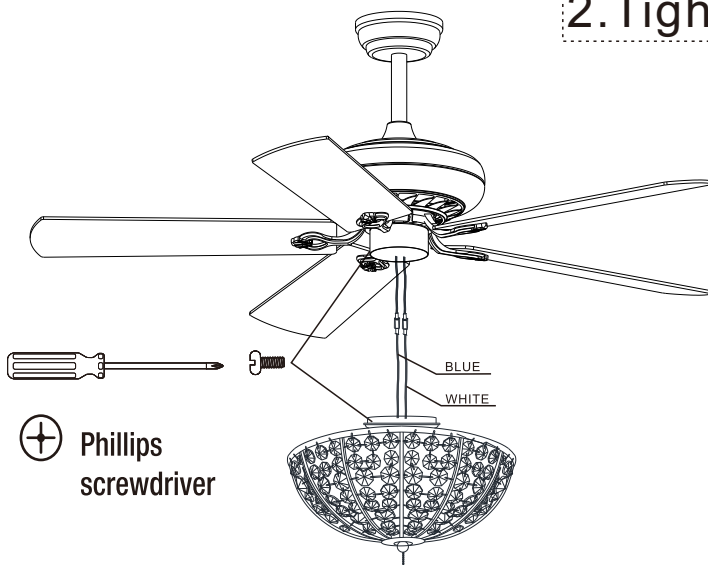

1. Take the wire into the switching box of the motor.
2. Align the opening of switching box of the light at switch locking position of the positive and negative rotation of the motors switching box. Place the cover. Screw in the screw of the switching box.

Assembly – Attaching the Lights

1. Install the crystal shade & bulb



WARNING: Allow the shatter resistant bowl to cool completely before removing.



CAUTION: Make sure the power is off before attaching or removing the shatter resistant bowl.



CAUTION: Do not over tighten the hex nut, overtightening the hex nut may cause the shatter resistant bowl to break.

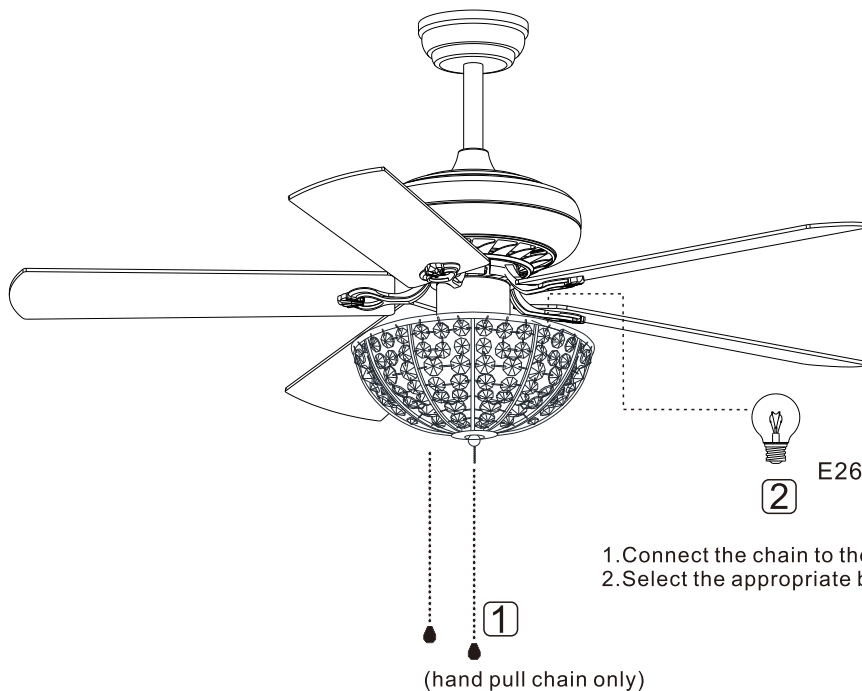

1. Connect the chain to the fan and the light switch. (hand pull chain only)
2. Select the appropriate bulb and install it on the lamp holder.

Operation

OPERATING YOUR FAN

Turn on the power and check the operation of the fan. The fan pull chain controls the fan speed as follows:

1 pull–High, 2 pulls–Medium, 3 pulls–Low, 4 pulls–off

The appropriate speed settings for warm or cool weather depends on factors such as the room size, ceiling height, and number of fans.

The slide switch (XX) controls the direction of the blades: forward (switch down) or reverse (switch up).



NOTE: Wait for the fan to stop before reversing the direction of the blade rotation

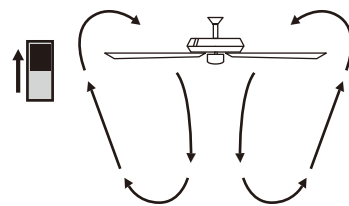

A. Warm Weather
(summertime)

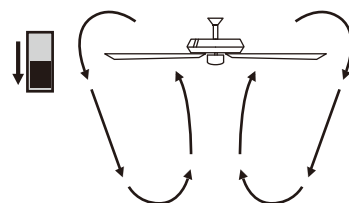

B. Cool Weather
(wintertime)

A. Warm weather-(Forward) A downward airflow creates a cooling effect. This allows you to set your air conditioner on a higher setting without affecting your comfort.

B. Cool weather-(Reverse) An upward airflow moves warm air off of the ceiling. This allows you to set your heating unit on a lower setting without affecting your comfort.

Use of remote control

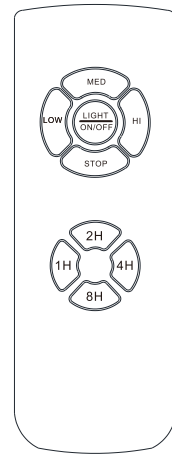
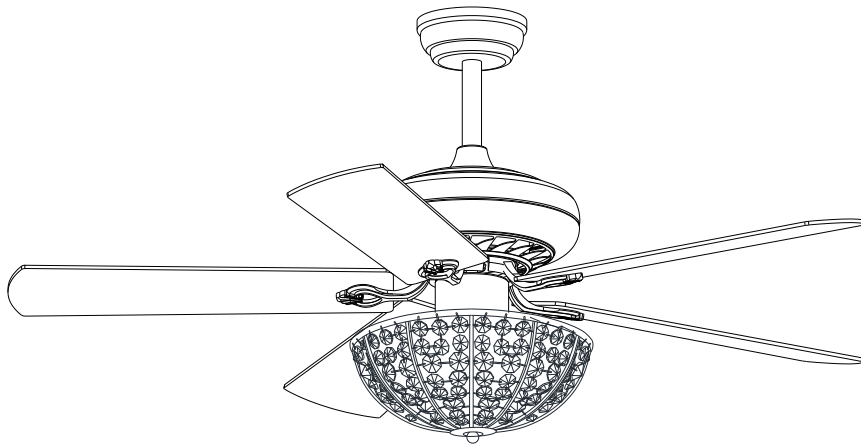

remote control <ONLY>



LIGHT NO/OFF

- 1H Auto off after 1hr
- 2H Auto off after 2hr
- 4H Auto off after 4hr
- 8H Auto off after 8hr

- LOW FanSpeed Low Level
- MED FanSpeed Middle Level
- HI FanSpeed High level
- STOP FanSTOP

Remote control wiring diagram

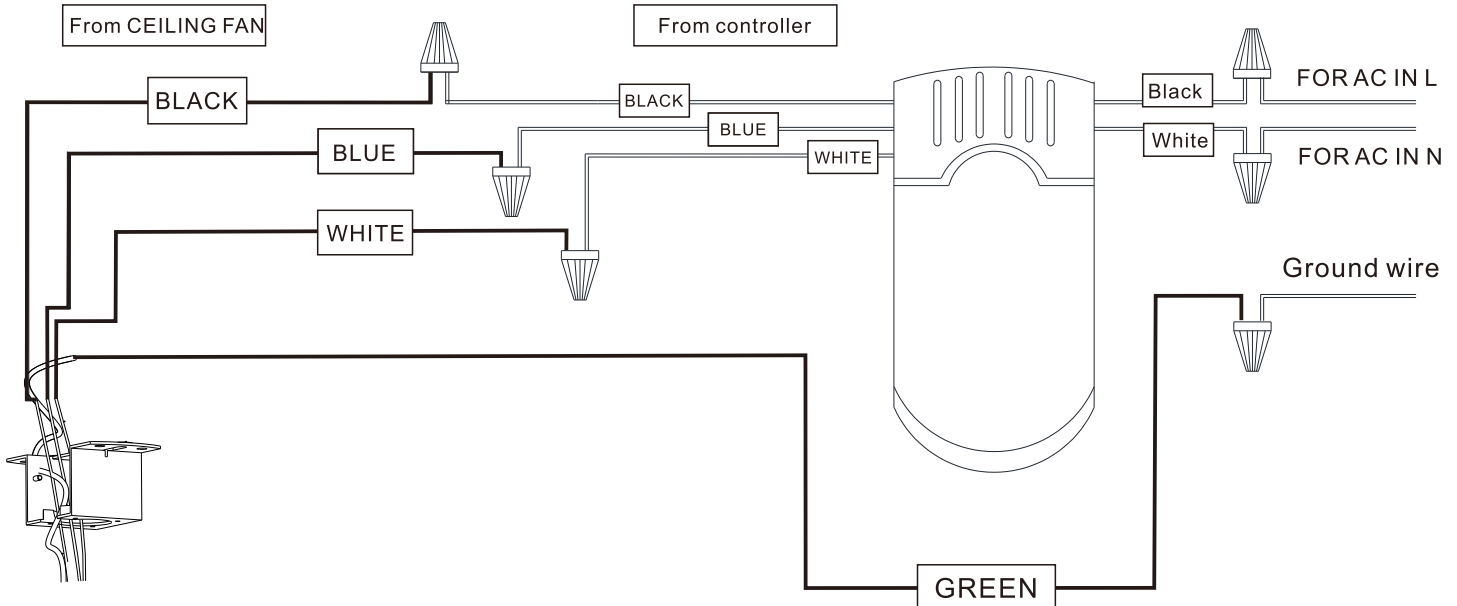

a. The motor **white** wire to the **white** "TO MOTORN" wire from Receiver with a wire nut.

b. The motor **black** wire to the **black** "to motor L" wire from Receiver with a wire nut.

c. The lamp **blue** wire to the **blue** "to Light" wire from Receiver with a wire nut.

d. The **white** wire from Outlet Box to the red "AC in N" wire from Receiver with a wire nut.

e. The **black** wire from Outlet Box to the red "AC in L" wire from Receiver with a wire nut.

Connect the supply ground wire to green ground wire from canopy and the green ground wire from the hanger bracket together using a wire nut.

Tuck all wire nuts and wires carefully up into the Outlet Box, EXCEPT antenna, which should remain outside Outlet Box

Care and Cleaning



WARNING: Make sure the power is off before cleaning your fan.

- Because of the fan's natural movement, some connections may become loose. Check the support connections, brackets, and blade attachments twice a year. Make sure they are secure. It is not necessary to remove the fan from the ceiling.
- Clean your fan periodically to help maintain its new appearance over the years. Do not use water when cleaning, as this could damage the motor or the wood, or possibly cause an electrical shock. Use only a soft brush or lint-free cloth to avoid scratching the finish. The plating is sealed with a lacquer to minimize discoloration or tarnishing.
- You can apply a light coat of furniture polish to the wood for additional protection and enhanced beauty. Cover small scratches with a light application of shoe polish.
- You do not need to oil your fan. The motor has permanently-lubricated sealed ball bearings.

Troubleshooting

Problem	Solution
The fan will not start.	<ul style="list-style-type: none"> <input type="checkbox"/> Check the main and branch circuit fuses or breakers. <input type="checkbox"/> Check the line wire connections to the fan and switch wire connections in the switch housing.
The fan will not start.	<ul style="list-style-type: none"> <input type="checkbox"/> Ensure all motor housing screws are snug. <input type="checkbox"/> Ensure the screws that attach the fan blade bracket to the motor hub are tight. <input type="checkbox"/> Ensure the wire nut connections are not rattling against each other or the interior wall of the switch housing. <input type="checkbox"/> Allow a 24-hour "breaking in" period. Most noises associated with a new fan disappear during this time. <input type="checkbox"/> If you are using the Ceiling Fan light kit, ensure the screws securing the glassware are tight. Check that the light bulbs are also secure. <input type="checkbox"/> Ensure the canopy is a short distance from the ceiling. It should not touch the ceiling. <input type="checkbox"/> Ensure your outlet box is secure and rubber isolator pads were used between the mounting plate and outlet box.
The fan wobbles.	<ul style="list-style-type: none"> <input type="checkbox"/> Check that all blade and blade arm screws are secure. <input type="checkbox"/> Most fan wobble problems are caused when blade levels are unequal. Check this level by selecting a point on the ceiling above the tip of one of the blades. Measure from a point on the center of each blade to the point on the ceiling. Measure this distance. Rotate the fan until the next blade is positioned for measurement. Repeat for each blade. Any measurement deviation should be within 1/8 in. Run the fan for ten minutes. If the fan continues to wobble please contact Customer Service and a balancing kit will be sent to you a

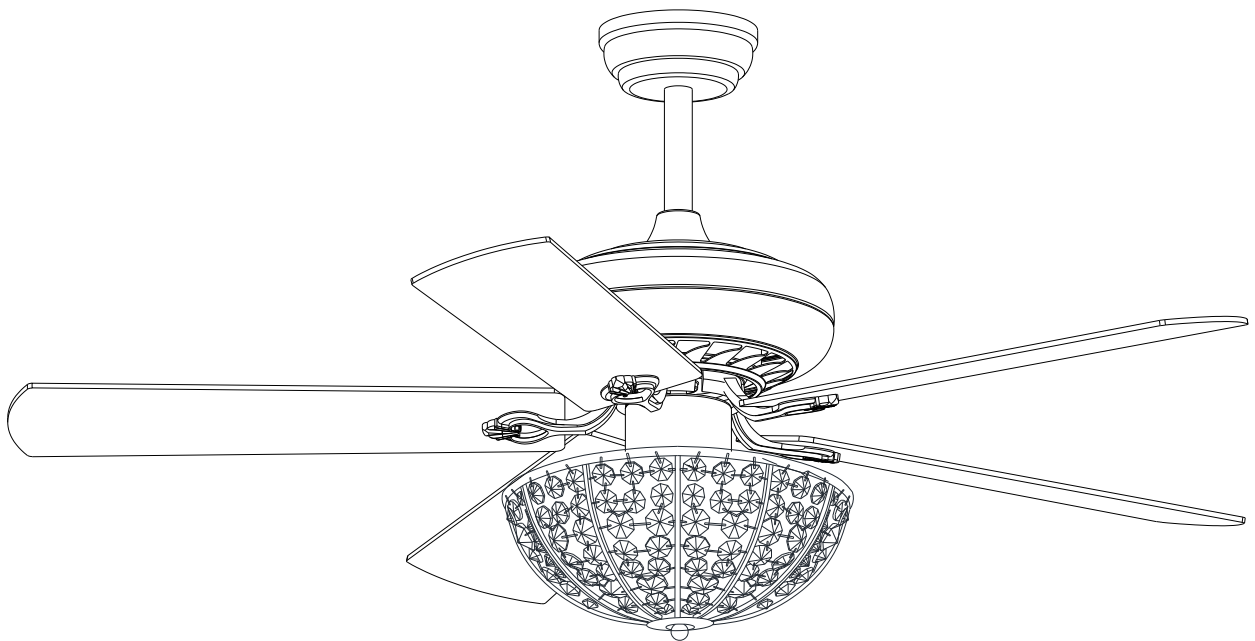

USE AND CARE GUIDE

52-INCH TIFFANY CEILING FAN