

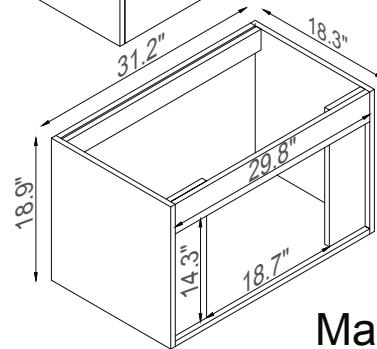

Streamline

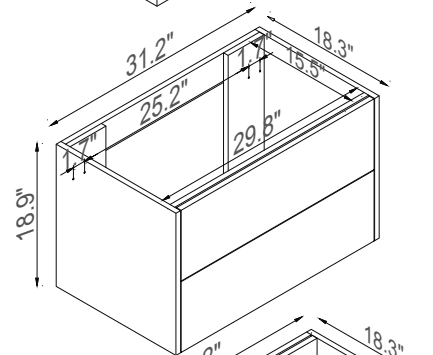
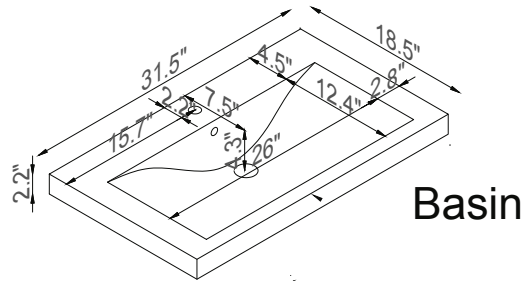
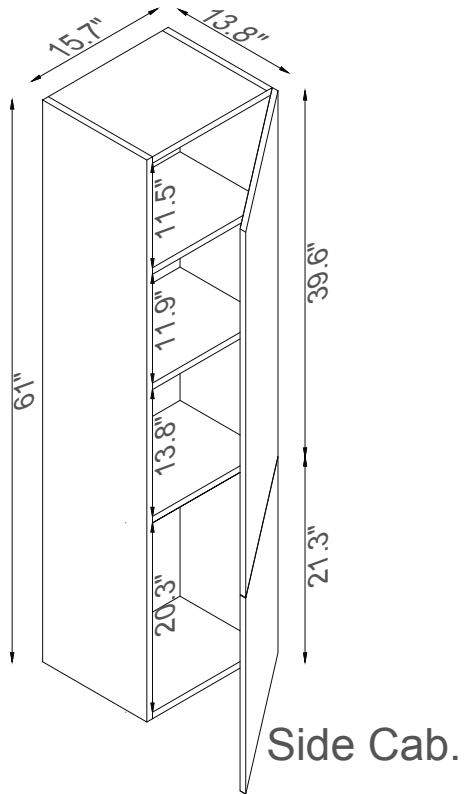

Master Cabinet

K1500-098-32-511S