

INSTALLATION INSTRUCTIONS

CHOOSE THE PROPER LOCATION

⚠ WARNING

- **The washer is heavy. Two or more people are required when moving and unpacking the washer.** Failure to do so may result in damage to property or serious bodily harm.
- **Store and install the washer where it will not be exposed to temperatures below freezing or exposed to outdoor weather conditions.** Failure to follow this warning can cause serious injury, fire, electric shock, or death.
- **Properly ground the washer to conform with all electric governing codes and ordinances.** Failure to follow this warning can cause serious injury, fire, electric shock, or death.
- **To reduce the risk of electric shock, do not install the washer in humid spaces.** Failure to follow this warning can cause serious injury, fire, electric shock, or death.
- **To ensure proper air flow, do not block the large opening on the bottom of the washer with carpeting or other materials.**
- **Do not remove ground prong. Do not use an adapter or extension cord. Plug into a grounded 3-prong outlet.** Failure to follow this warning can cause serious injury, fire, electric shock, or death.

POWER OUTLET

- The power outlet must be within 60 in. (1.5 m) of either side of the washer.
- The appliance and outlet must be positioned so that the plug is easily accessible.
- Do not overload the outlet with more than one appliance.
- The outlet must be grounded in accordance with current wiring electric codes and regulations.
- Time-delay fuse or circuit breaker is recommended.

NOTE: It is the personal responsibility and obligation of the product owner to have a proper outlet installed by a qualified service technician.

FLOORING

- To minimize noise and vibration, the washer **MUST** be installed on a solidly constructed floor.
- Allowable slope under the entire washer is a maximum 1 inch. difference from side to side or from front to back.
- Installing on carpeting and soft tile surfaces is not recommended.
- Never install the washer on a platform or weakly supported structure.

NOTE: The washer must be installed on firm flooring to minimize vibration during the spin cycle. Concrete flooring is best, but a wood floor is sufficient, provided it is built to FHA standards. The washer should not be installed on rugs or exposed to weather.

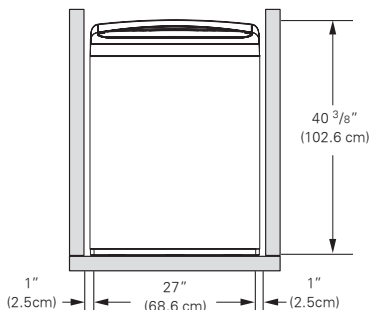

To ensure sufficient clearance for water lines and airflow, allow minimum clearances of at least 1 in. (2.5 cm) at the sides and 4 in. (10 cm) behind the unit. Be sure to allow for wall, door, or floor moldings that may increase the required clearances.

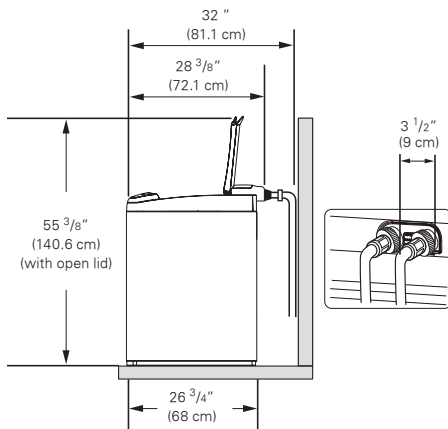

Minimum vertical space from floor to overhead shelves, cabinets, ceilings, etc., is 56 in.

UNPACKING AND REMOVING SHIPPING MATERIAL

1. After removing the carton and shipping material, lift the washer off the foam base. Make sure the plastic tub support comes off with the base and is not stuck to the bottom of the washer.

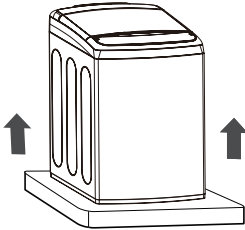

If you must lay the washer down to remove the base packaging materials, always protect the side of the washer and lay it carefully on its side. DO NOT lay the washer on its front or back.

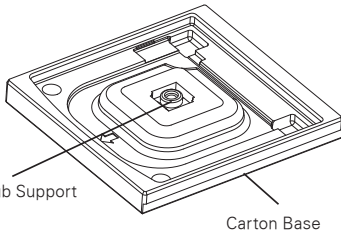

2. Save the foam block (that contains the Owner's Manual, parts and laundry product samples) for future use. If the washer must be moved in the future, the foam block will help prevent damage to the washer during transportation.

NOTE: To prevent damage, do not remove the foam block until the washer is at the final location.

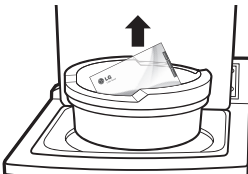

3. Carefully remove the two foam pads which cover the top sides of the tub guide, making sure not to leave behind any pieces of the foam.

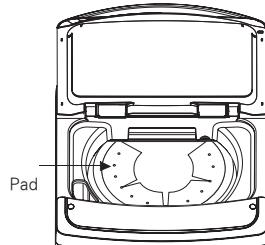

4. Unfasten the power cord from the back of the washer.

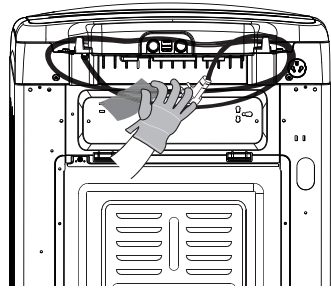

TOOLS YOU WILL NEED

- Adjustable Pliers

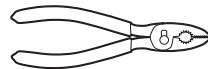

- Carpenter's Level



CONNECTING THE WATER LINES

- LG recommends the use of LG hoses. Any leaking, property damage, or damage to the washing machine caused by an improper installation or by the use of non-LG hoses is not covered under the terms of the LG warranty and is the sole responsibility of the customer and/or an installer.
- Water supply pressure must be between 20 psi and 120 psi (138~827 kPa). If the water supply pressure is more than 120 psi, a pressure reducing valve must be installed.
- Periodically check the hose for cracks, leaks, and wear, and replace the hose if necessary.
- Make sure that the water lines are not stretched, pinched, crushed, or kinked.
- The washer should never be installed or stored in a location subject to freezing temperatures. Damage to the water lines and internal mechanisms of the washer can result. If the washer was exposed to freezing temperatures prior to installation, allow it to stand at room temperature for several hours before use and check for leaks prior to operation.

NOTE: Do not use flood-preventing hoses with auto shutoff devices. The devices can be tripped during fill and prevent the machine from filling properly.

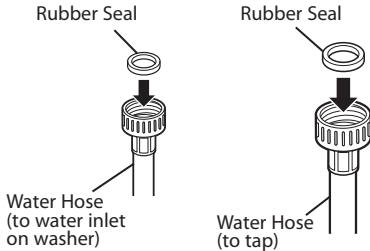

1. Inspect the threaded fitting on each hose and make sure there is a rubber seal in place in both ends of each hose.

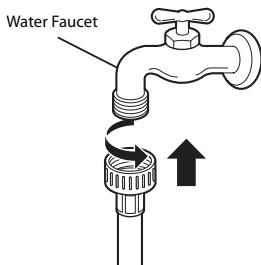

⚠ WARNING

- **Do not reuse old hoses.** Only use new hoses when you install the washing machine. Old hoses could leak or burst causing flooding and property damage.

2. Connect the water supply hoses to the HOT and COLD water faucets tightly by hand and then tighten another 2/3 turn with pliers.

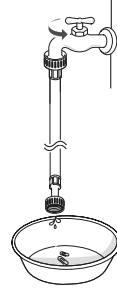

⚠ WARNING

- **Do not overtighten.** Damage to the coupling can result.

3. Always run a gallon or two of water through each inlet hose to flush dirt, scale and other debris out of the water lines. Doing so will help prevent future problems with clogged filter screens, and will also allow you to verify which water line is hot and which is cold.

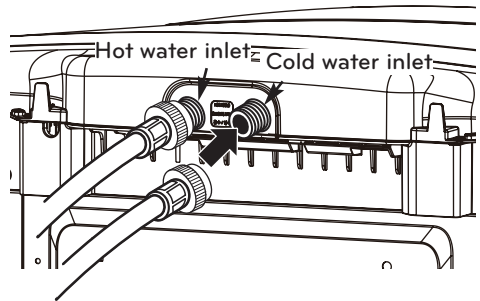

⚠ WARNING

- **Do not overtighten the hoses.** Overtightening can damage the valves resulting in leaking and property damage.

4. Attach the hot water line to the hot water inlet on the back of the washer. Attach the cold water line to the cold water inlet on the back of the washer. Tighten the fittings securely. Turn ON both faucets all the way and check for leaks at both ends of the hoses.

NOTE: Be careful not to cross-thread the hose fittings. This will damage the valve and could result in property damage from leaks.

CONNECTING THE DRAIN HOSE

- The drain hose should always be properly secured. Failure to properly secure the drain hose can result in flooding and property damage.
- The drain must be installed in accordance with any applicable local codes and regulations.
- Make sure that the drain hose is not stretched, pinched, crushed, or kinked.

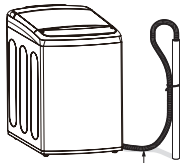

Drain Hose

OPTION 1: STANDPIPE

Bend the outlet end of the drain hose to form a U shape. Insert the end of the drain hose into the drain. If the drain is large enough for the flange on the hose to fit inside, then do not insert the flange more than 1-2 inches into the drain. Use the tie strap included with the installation materials in the foam block in the tub to secure the drain hose to the drain.

If the water valves and drain are built into the wall,

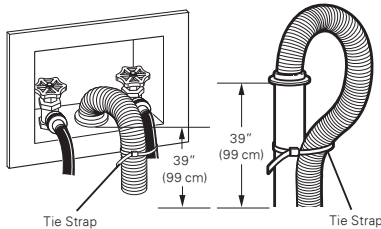

Tie Strap

Tie Strap

fasten the drain hose to one of the water hoses with the tie strap (ribbed side on inside).

If your drain is a standpipe, fasten the drain hose to the standpipe with the tie strap provided.

NOTE:

- Normal height of the end of the hose should be approximately 35"~47" (0.9~1.2 m) from the floor.
- Do not install the end of the drain hose lower than 29 in. (73.7 cm) or higher than 96 in. (243.8 cm) above the bottom of the washer or more than 60 in. (152.4 cm) away from the washer.
- Never create an airtight seal between the hose and the drain with tape or other means. If no air gap is present, water can be siphoned out of the tub resulting in poor wash/rinse performance or clothing damage.

CAUTION

- Do not insert the end of the drain hose into the standpipe more than 8 inches (20cm). **Doing so can cause siphoning, odors, or improper draining.**

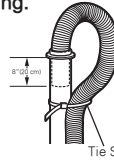

No more than 8 inches (20cm)

Tie Strap

OPTION 2: LAUNDRY TUB

Bend the end of the drain hose to the desired shape and support it on the edge of the laundry tub. Use the tie strap to secure the drain hose in place.

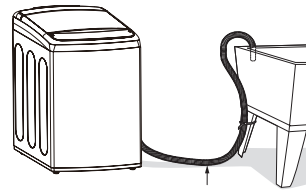

Drain Hose

NOTE:

- Do not use this drain hose with a floor drain. The end of the drain hose must be at least 29 inches above the floor for proper draining to occur.

LEVELING THE WASHER

The tub of your new washer spins at very high speeds. To minimize vibration, noise, and movement, the floor must be a level, solid surface.

NOTE:

- Adjust the leveling feet only as far as necessary to level the washer. Extending the leveling feet more than necessary can cause the washer to vibrate.
- Before installing the washer, make sure that the floor is clean, dry and free of dust, dirt, water and oil so the washer feet cannot slide easily. Leveling feet that move or slide on the floor can contribute to excessive vibration and noise due to poor contact with the floor.

All four leveling feet must rest solidly on the floor. Attempt to rock the washer from corner to corner to make sure that all four leveling feet are in firm contact with the floor.

1. Position the washer in its final location, taking special care not to pinch, strain, or crush the water and drain lines. Place a level across the top of the washer.

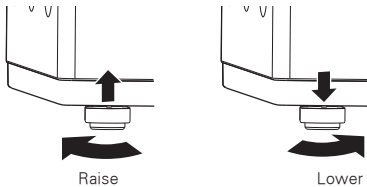

2. Adjust the leveling feet. Turn clockwise to raise the washer or counterclockwise to lower it.

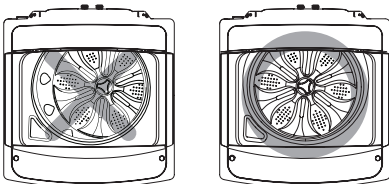

3. To make sure that the washer is properly level, open the lid and look from above to see if the tub is centered. If the tub is NOT centered (as shown in the drawing with the X through it), readjust the front feet. If you have a level, check your washer with the level.

- To check if the washer is level from side to side, place a level on the back edge of the lid.
- To check if the washer is level front to back, place a level at the side of the washer on the edge where

the cabinet side meets the top cover. Do not place the level on the top of the lid. Using these surfaces will result in the washer being unlevel.

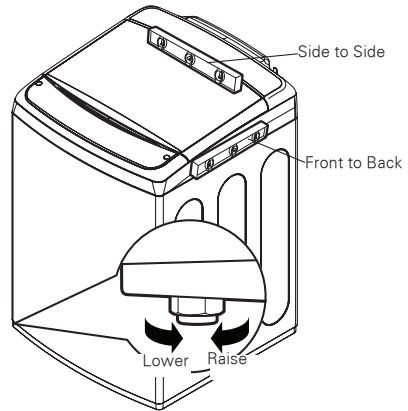

⚠ WARNING

- Using the washing machine without leveling it may result in malfunction caused by the production of excess vibration and noise.
- **Use the leveling feet only when you level the washing machine.** If you raise the leveling feet unnecessarily, it may cause abnormal vibration of the washing machine.

NOTE:

- If the lid will not stay open, the washer may need to be leveled. Extend the front leveling legs until the washer is level.

CONNECT TO THE POWER SUPPLY SORTING WASH LOADS

The washer should be plugged into a 120-VAC, 60-Hz grounded 3-prong outlet. Plug in the washer. Improper connection of the equipment-grounding conductor can result in risk of electric shock. Check with a qualified electrician or service technician if you are in doubt as to whether the appliance is properly grounded. Do not modify the plug provided with the appliance. If it does not fit the outlet, have a proper outlet installed by a qualified electrician. Failure to follow these warnings can cause serious injury, fire, electrical shock, or death.

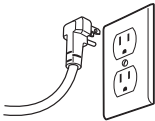

⚠️ WARNING

- The power outlet must be within 60 inches (1.5 m) of either side of the washer.
- The appliance and outlet must be positioned so that the plug is easily accessible.
- Do not overload the outlet with more than one appliance.
- The outlet must be grounded in accordance with current wiring codes and regulations.
- Time-delay fuse or circuit breaker is recommended.
- It is the personal responsibility and obligation of the product owner to have a proper outlet installed by a qualified electrician.
- Do not use a worn or damaged power cord or power plug. Replace or repair it immediately. Failure to do so may result in death, fire, electric shock, or malfunction.
- Do not modify the power cord and take care not to damage it when installing or moving the washing machine. Failure to do so may result in death, fire, electric shock, or malfunction.
- Make sure that the washing machine is grounded.
- Connect this washing machine to a grounded outlet conforming to the rating prior to use. Failure to do so may result in fire, electric shock, or malfunction.
- Do not use adaptors or extension cords. The washing machine should always be plugged into its own individual electrical outlet which has a voltage rating that matches the rating plate. Failure to do so may result in fire, electric shock or disorder.
- Do not damage or cut off the ground prong of the power cord. Doing so may cause death, fire, electric shock, or product malfunction.

⚠️ CAUTION

- Do not load items higher than the top edge of the tub. Failure to follow this caution can result in leakage or damage to fabrics.
- Use the Bedding cycle for buoyant or nonabsorbent items such as pillows or comforters. Failure to follow this caution can result in leakage.
- If possible, do not wash any water-resistant items. If you must, please select the Waterproof cycle. (i.e. Water resistant clothing, mattress covers, outdoor clothes, plastic mats etc.)
- If waterproof material laundry is washed in a course other than Waterproof, it may result in injury or damage to the washer, clothes, walls, floor, and surrounding objects due to abnormal vibration.

GROUPING SIMILAR ITEMS

For the best washing results, and to reduce the possibility of damage to clothing, care should be taken to sort the clothing into loads that are made up of similar items.

Mixing different fabric types and/or soil levels can result in poor wash performance, color transfer, discoloration, fabric damage or linting. Fabrics should be sorted into groups as described below.

COLORS

Sort articles by color. Wash dark clothes together in a separate load from light colors or whites. Mixing dark clothes with light clothes can result in dye transfer or discoloration of the lighter clothes.

SOIL LEVEL

Wash heavily soiled clothing together. Washing lightly soiled clothing in the same load with heavily soiled clothing could result in poor wash performance for the lightly soiled clothing.

FABRIC TYPE

Delicate articles should not be mixed with heavier or sturdier fabric types. Washing heavier fabrics in a delicate load can result in poor wash performance for the heavier fabrics and possible damage to the delicacies.

LINT TYPE

Some fabrics attract and bind lint to them while others give off lint in the laundry process. Avoid mixing these lint collectors and lint producers in the same load. Mixing these fabrics will result in pilling and linting on the lint collectors. (For example, lint collector – knit sweater; lint producer – terry cloth towels.)

SORT LAUNDRY...



By Colors	By Soil	By Fabric	By Lint
White	Heavy	Delicates	Lint Producer
Lights	Normal	Easy Care	Line Collector
Darks	Light	Sturdy	

FABRIC CARE LABELS



Many articles of clothing include a fabric care label. Using the chart below, adjust the cycle and option selections to care for your clothing according to the manufacturer's recommendations.

Fabric Care Labels



Machine wash cycle

		
Normal	Permanent press/ wrinkle resistant	Gentle/ delicate



Hand wash

		
Hand wash	Do not wash	Do not wring

Water temperature

		
Hot	Warm	Cold/cool

Bleach symbols

		
Any bleach (when needed)	Only non-chlorine bleach (when needed)	Do not bleach

LOADING THE WASHER



- Check all pockets to make sure that they are empty. Items such as clips, matches, pens, coins, and keys can damage both your washer and your clothes.
- Close zippers, hooks, and drawstrings to prevent these items from snagging or tangling on other clothes.
- Pretreat heavily stained areas for best results.
- Combine large and small items in a load. Load large items first.
- Large items should not be more than half of the total wash load.
- The washer can be fully loaded, but the tub should not be tightly packed with items. The lid of the washer should close easily.
- To prevent an out-of-balance load, do not wash single items. Add one or two similar items to the load. Large, bulky items, such as a blanket, comforter, or bedspread, should be washed individually.
- Waterproof items do wash or spin Waterproof cycle. (i.e. Water resistant clothing, mattress covers, outdoor clothes, plastic mats etc.)
- The washer will not fill or operate with the lid open.

NOTE: Use the Bedding cycle for large or bulky items such as poly-filled jackets, comforters, pillows, etc. These items may not be as absorbent as other laundry items and should be sorted into a separate wash load for optimal results.

Bulky items should be placed as far down in the tub as possible for optimal results. Always place buoyant items at the bottom of the tub. The washer will automatically detect the load size. Because of the high-efficiency wash system, the water level may not completely cover the load.

1. For best performance, load clothes as shown.

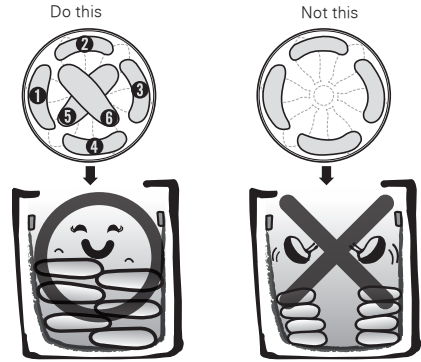

2. Load clothes loosely, and do not load clothes over the maximum guideline on the tub. Clothes need room to circulate in order to get clean.

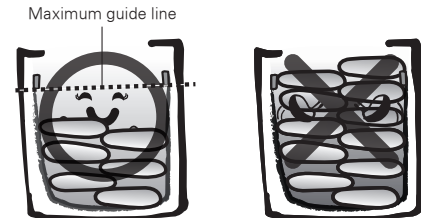

ABOUT THE DISPENSERS

The automatic dispenser consists of two compartments which hold:

- Liquid fabric softener.
- Liquid or powdered detergent for the main wash.

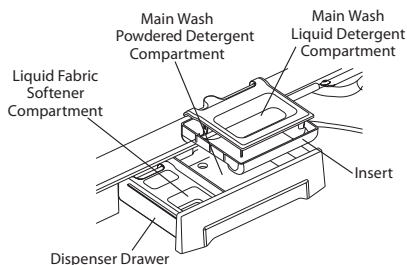

MAIN WASH DETERGENT COMPARTMENT

This compartment holds laundry detergent for the main wash cycle. The detergent is added to the load at the beginning of the cycle. Always use High-Efficiency (HE) detergent with your washing machine. Either powdered or liquid detergent may be used.

Never exceed the manufacturer's recommendations when adding detergent. Using too much detergent can result in detergent buildup in clothing and the washer.

When using liquid detergent, make sure the liquid detergent cup and insert are in place. Do not exceed the maximum fill line.

When using powdered detergent, remove the liquid detergent cup from the compartment. Powdered detergent will not dispense with the liquid detergent cup in place.

FABRIC SOFTENER COMPARTMENT

This compartment holds liquid fabric softener, which is automatically dispensed during the final rinse cycle.

Never exceed the manufacturer's recommendations when adding softener. Using too much fabric softener can result in damage to clothing and the washer. Either powdered or liquid fabric softener.

- Always follow the manufacturer's recommendations when adding fabric softener. Do not exceed the maximum fill line. Using too much fabric softener may stain clothes.
- Dilute concentrated fabric softeners with warm water. Do not exceed the maximum fill line.
- Never pour fabric softener directly onto the load or into the tub.

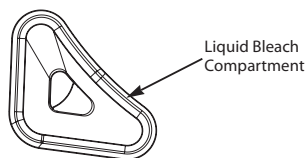

LIQUID BLEACH COMPARTMENT

The bleach dispenser is a separate compartment at the left front of the tub opening. This compartment holds liquid bleach, which is dispensed automatically at the proper time during the wash cycle. Any liquid remaining in the dispenser at the end of the cycle is water, not bleach.

- Do not add powdered bleach to this compartment. The bleach compartment is designed to dispense liquid bleach only. Powdered or liquid color-safe bleach will not dispense properly.
- Always follow the manufacturer's recommendations when adding bleach. Never add more than one cup and do not exceed the maximum fill line since this can cause the bleach to be dispensed immediately, resulting in damage to fabrics. Using too much bleach can damage fabrics.
- Never pour undiluted liquid chlorine bleach directly onto the load or into the tub. Fabric damage can occur.
- Do not use color-safe bleach or Oxi products in the same cycle with liquid chlorine bleach.

⚠ DANGER

Do NOT mix chlorine bleach with ammonia or acids, such as vinegar or rust/scale remover. Mixing chemicals like these can produce a lethal gas, resulting in severe injury or death.

DETERGENT AND DISPENSER USE A WORD ABOUT DETERGENTS

High-Efficiency (HE) detergents produce fewer suds, dissolve more efficiently to improve washing and rinsing performance, and help to keep the interior of your washer clean. Using detergent that is not HE may cause oversudsing and unsatisfactory performance which could result in error codes, cycle failure, and machine damage.

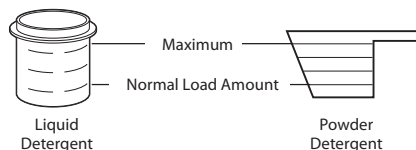

For proper wash performance, always measure the detergent using the measuring device provided by the detergent manufacturer.

The normal amount of HE detergent needed, for average loads, is less than ½ of the recommended maximum. Use less detergent for soft water, light soil or smaller loads. Never use more than the maximum amount recommended by the detergent manufacturer.



DESIGNED TO USE ONLY HIGH-EFFICIENCY (HE) DETERGENT

IMPORTANT: Your washing machine is designed for use with only High-Efficiency (HE) detergents. HE detergents are formulated specifically for High-Efficiency washers and contain suds-reducing agents. Always look for the HE symbol when purchasing detergent.

IMPORTANT: Not all detergents are the same. Pay careful attention to the amount of detergent used to avoid oversudsing, poor rinsing and detergent buildup in clothing, and residue buildup that can contribute to odors in the machine. NEVER use a cup or scoop other than the one supplied by the manufacturer of the detergent you are using. Never use more than the maximum amount of detergent recommended by the manufacturer. A full scoop or measure of detergent should only be used for very large and heavily soiled loads. Using too much detergent can result in detergent buildup in the washer and in your clothes.

Always measure the detergent amount. While HE detergents are designed for this type of washing machine, be careful when measuring the detergent. For most normal loads, no more than 1/4 to 1/2 a cap or scoop of HE detergent should be used.

NOTE:

- Extra care must be exercised when using 2X and 3X concentrated detergents because even a little bit extra can contribute to the problems mentioned above.
- Detergents designated as HE compatible may not provide optimal results.

USING THE SOFTENER AND DETERGENT DISPENSER

To add detergent, and fabric softener to the automatic dispenser:

1. Open the dispenser drawer.
2. Load the laundry products into the appropriate compartments.
3. Close the drawer before starting the cycle.

4. If using fabric softener on NORMAL or HEAVY DUTY cycles, press the FABRIC SOFTENER button or select the EXTRA RINSE option.

NOTE: It is normal for a small amount of water to remain in the bleach dispenser and softener compartment at the end of the cycle.

IMPORTANT: Do not place or store laundry products, such as detergent, bleach, or liquid fabric softener, on top of your washer or dryer. Wipe up any spills immediately. These products can damage the finish and controls.

USING THE LIQUID BLEACH DISPENSER

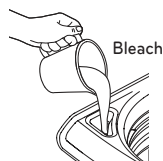

The bleach dispenser automatically dilutes and dispenses liquid bleach at the proper time in the wash cycle.

1. Check clothing care labels for special instructions.
2. Measure liquid bleach carefully, following instructions on the bottle. High-efficiency washers use less water, so less bleach is needed. One half cup is enough for most loads.
3. Carefully pour the pre-measured amount of bleach directly into the bleach dispenser. If you are using powdered bleach of any kind, pour it directly into the tub before adding the laundry. Never add powdered bleach to the liquid bleach dispenser.
 - Never pour undiluted liquid chlorine bleach directly onto clothes or into the tub.
 - Do not pour powdered bleach into bleach dispenser.
 - Do not place laundry items on top of the bleach dispenser when loading and unloading the washer.
 - Always measure and pour bleach carefully. Avoid overfilling or splashing when adding bleach to the dispenser. The maximum capacity of the bleach dispenser is one cup of bleach per wash cycle. Overfilling could result in bleach being dispensed immediately, which can result in damage to the clothes in the washer.

HOW TO USE

CONTROL PANEL FEATURES

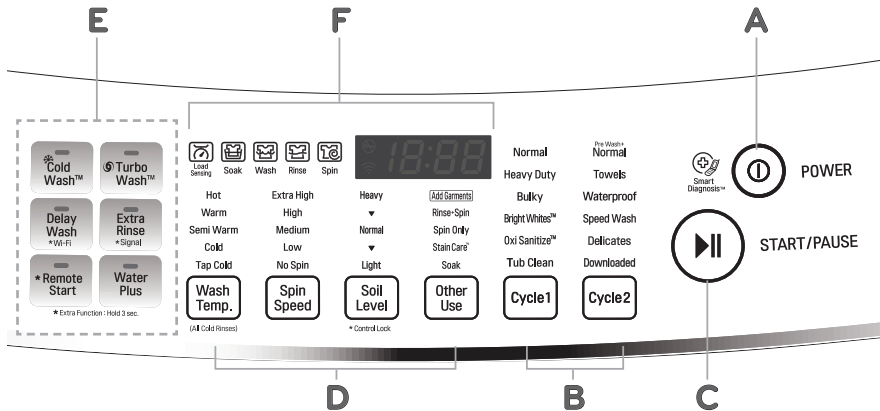

A POWER (ON/OFF) BUTTON

Press to turn the washer ON. Press again to turn the washer OFF. Pressing the POWER button during a cycle will cancel that cycle and any load settings will be lost. The lid will unlock after a brief pause.

NOTE: If there is any water remaining in the tub after the washer shuts off, it will drain following a five minute delay. The washer can be restarted any time before the drain begins. However, once the water begins to drain, all functions will be suspended until the water has been completely drained and the washer shuts off.

B CYCLE SELECTOR BUTTON

Press the Cycle Button repeatedly until the desired cycle is selected. Once the desired cycle has been selected, the standard presets will appear in the display. These settings can be adjusted using the cycle setting buttons anytime before starting the cycle.

NOTE: To protect your clothing, not all settings are available on all cycle selections.

C START/PAUSE BUTTON

Press this button to start the selected cycle. If the washer is running, use this button to pause the cycle without losing the current settings.

NOTE: If you do not press the START/PAUSE button within five minutes of selecting a cycle, the washer automatically turns OFF and all cycle settings are lost. Any water remaining in the tub will drain after a five minute delay.

D CYCLE MODIFIER BUTTONS

Use these buttons to adjust the settings for the selected cycle. The setting lights above the buttons illuminate to show the current selection.

E SPECIAL CYCLE AND OPTION BUTTONS

These buttons allow you to select special cycles or options.

F TIME AND STATUS DISPLAY

The display shows the cycle status and estimated time remaining.

TIME AND STATUS DISPLAY

The time and status display shows the estimated time remaining and cycle progress.

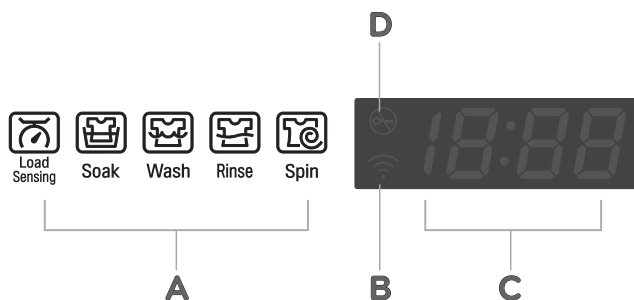

A CYCLE STATUS INDICATOR

These LEDs will illuminate when a cycle is selected to indicate which stages will run. When a cycle is running, the LED for the active stage will blink, and the LEDs for the remaining stages will remain steady. Once a stage is complete, the LED will turn off. If a cycle is paused, the active stage LED will stop blinking.

B WI-FI CONNECT INDICATOR

The indicator blinks during product registration and Wi-Fi setup and illuminates when the appliance is connected to a home Wi-Fi network.

C ESTIMATED TIME REMAINING

When a cycle is selected, the default time for that cycle is displayed. This time will change as modifiers or options are selected. Once the START/PAUSE button is pressed, the washer will measure the size of the load. The estimated time may change once the load size has been measured. If Delay Wash is set, the remaining delay time counts down until the cycle begins.

NOTE: The time shown is only an estimate. This time is based on normal operating conditions. Several external factors (load size, room temperature, incoming water temperature, etc.) can affect the actual time.

D LID LOCK INDICATOR

The Lid lock indicator will illuminate once a cycle has started. The indicator light will stay on until the cycle is paused, stopped, or has finished.

OPERATING THE WASHER

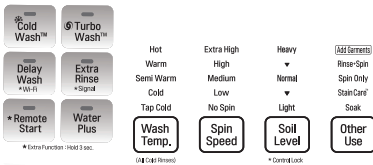
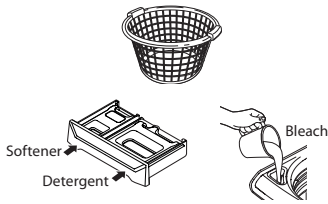

Add Garments



1 SORT LAUNDRY AND LOAD THE WASHER

Sort laundry by fabric type, soil level, color and load size, as needed. Open the lid and load items into the washer.

2 CLEANING PRODUCTS

Add High-Efficiency (HE) detergent to the detergent dispenser. If bleach or fabric softener is to be used, add these to the appropriate dispensers.

3 TURN ON THE WASHER

Press the POWER button to turn ON the washer. The lights around the cycle selector knob will illuminate and a chime will sound.

4 CYCLE SELECTOR BUTTON

Press the Cycle Button repeatedly until the desired cycle is selected. The preset Wash Temp., Spin Speed, Soil Level, Special Use and option settings for that cycle will be shown. Pressing the Start/Pause button without selecting a cycle will cause the NORMAL cycle to begin immediately.

5 ADJUST SETTINGS

Default settings for the selected cycle can now be changed, if desired, using the cycle modifier and option buttons.

NOTE: Not all modifiers and options are available on all cycles. A different chime will sound and the LED will not come on if the selection is not allowed.

6 BEGIN CYCLE

Press and hold the START/PAUSE button to begin the cycle. The lid will lock, and the washer will agitate briefly without water to measure the weight of the load. If the START/PAUSE button is not pressed within 5 minutes, the washer will shut off and all settings will be lost.

7 ADD GARMENTS LIGHT

The Add Garments light will illuminate near the beginning of the wash cycle to indicate when it is safe to add items to the load. Press the START/PAUSE button to pause the cycle and add garments to the load. Press the START/PAUSE button to resume the cycle.

NOTE: It is not recommended to add items unless the ADD GARMENTS light is illuminated, as this could result in poor performance and/or clothing damage.

8 END OF CYCLE

When the cycle is finished, a melody will sound. Immediately remove your clothing from the washer to reduce wrinkling.

⚠ WARNING

- To reduce the risk of fire, electric shock, or injury to persons, **read the IMPORTANT SAFETY INSTRUCTIONS** before operating this appliance.

CYCLE GUIDE

The cycle guide below shows the default settings, available options and recommended fabric types for each cycle. Allowable modifier adjustments are shown below the default setting for each cycle.

 Default Setting

Cycle	Fabric or Load Type	Wash Temp.	Spin Speed	Soil Level	Soak	Stain Care™	Cold Wash™	Extra Rinse	Water Plus	Turbo Wash™
Normal	Cotton, linen, towels, shirts, sheets, jeans, mixed loads	Hot	Extra high	Heavy						
		Warm	High							
		Semi Warm	Medium	Normal	●	●	●	●	●	●
		Cold	No spin	Light						
Heavy Duty	Heavily soiled cotton fabrics	Hot	Extra high	Heavy						
		Warm	High							
		Semi Warm	Medium	Normal	●	●		●	●	●
		Cold	Low	Light						
Bulky	Large items such as blankets and comforters	Hot		Heavy						
		Warm								
		Semi Warm	Medium	Normal	●		●	●		
		Cold	Low	Light						
Bright Whites™	White fabrics	Hot	Extra High	Heavy						
		Warm	High							
		Semi Warm	Medium	Normal	●			●	●	●
		Low	No Spin	Light						
OXI SANITIZE™	Cotton, underwear, pillow covers, bed sheets, baby wear. (less than 11 lbs.)	Hot	Extra high	Heavy						
			High							
			Medium	Normal				●	●	●
			Low	Light						
Tub Clean	Refer to page 27.	Hot	High							
				Light						

* Use the BULKY cycle for items such as pillows, comforters, pet bedding and other articles which have difficulty absorbing water. DO NOT WASH EXCESSIVELY LARGE ITEMS. If large/bulky items do not fit easily into the tub, there may not be enough room for them to move during washing. Keep like items together; do not mix large bulky items with smaller clothing items. Failure to follow these instructions may result in damage to the clothing or to the washer.

CYCLE GUIDE

The cycle guide below shows the default settings, available options and recommended fabric types for each cycle. Allowable modifier adjustments are shown below the default setting for each cycle.

 Default Setting

Cycle	Fabric or Load Type	Wash Temp.	Spin Speed	Soil Level	Soak	Stain Care™	Cold Wash™	Extra Rinse	Water Plus	Turbo Wash™
Pre Wash+ Normal	Towels, shirts, sheets, jeans, mixed loads	Hot	Extra high							
		Warm	High							
		Semi Warm	Medium	Normal	●			●	●	●
		Cold	Low	Light						
Waterproof	Waterproof or water resistant items: mattress covers, outdoor clothing, plastic mats, etc. (less than 14 lb.)	Tap cold	No spin	Light						
		Warm		Heavy						
		Semi Warm		Normal						
		Cold	Low	Light				●	●	
Delicates	Dress shirts/blouses, nylons, sheer or lacy garments (less than 8 lbs.)	Tap cold	No spin	Light						
		Warm		Heavy						
		Semi Warm		Normal	●			●	●	
		Cold	Low	Light						
Towels	Towels, shirts, sheets, jeans, mixed loads	Tap cold	No Spin	Light						
		Hot	Extra High	Heavy						
		Warm	High							
		Semi Warm	Medium	Normal	●	●	●	●	●	●
Speed Wash	Lightly soiled and small loads	Cold	Low	Light						
		Tap cold	No spin	Light						
		Warm	Extra high	Heavy						
		Semi Warm	High	Normal	●			●	●	●
Downloaded	The down-loaded cycle (See page 22.)	Cold	Low	Light						
		Tap cold	No spin	Light						
		Warm	Extra high	Heavy						
		Semi Warm	High	Normal	●			●	●	●

WASH CYCLES

Wash cycles are designed for the best wash performance for each type of load. Select the cycle that best matches the load contents for maximum wash performance and fabric care. When you select a wash cycle, the light for the corresponding wash cycle will turn on. See page 19, **OPERATING THE WASHER**, for more details on operating methods.

Normal

Use this cycle to wash all normal items, except delicate fabrics such as wool or silk.

NOTE: Pressing the START/PAUSE button without selecting a cycle will cause the NORMAL cycle to begin immediately using the default settings.

Heavy Duty

This cycle is for washing heavily soiled laundry using more powerful wash motions.

NOTE: When washing large loads, in order to deliver the best performance, there will be brief periods of 2 minutes or more without agitation. These soak periods are part of the cycle's design, and are normal.

Bulky

This cycle is for washing blankets or bulky items.

NOTE: Do not use this cycle to wash a mixed load of bedding and non-bedding items.

BRIGHT WHITES™

This cycle is for washing white items only.

OXI SANITIZE™

This wash cycle reduces 99.9% of bacteria on laundry when used in conjunction with bleach without high energy consumption.

NOTE:

- Follow the product manufacturer's instructions for using Oxi products with this cycle.
- Never load powdered products into the liquid bleach dispenser. Doing so can result in the product not being dispensed or being dispensed incorrectly. Powders can clog the bleach dispenser, resulting in leaks or damage to the washer or your clothing.

TUB CLEAN

Use this cycle to clean the tub of your washing machine.

Pre Wash+ Normal

Use this cycle to prewash stains without needing to hand-wash. Prompt treatment helps to prevent stains from setting or odors from developing.

Waterproof

This cycle is used for washing waterproof material.

NOTE:

- Do not use any other wash cycle to wash waterproof fabrics. (i.e. Water resistant clothing, mattress covers, outdoor clothes, plastic mats etc.)
- Do not use this cycle to wash a mixed load of waterproof and non-waterproof items.
- Use only the waterproof cycle, after checking the washing instruction label on the fabric.
- Do not wash other fabrics using the waterproof cycle.

WARNING

- If waterproof material laundry is washed in a course other than Waterproof, it may result in injury or damage to the washer, clothes, walls, floor, and surrounding objects due to abnormal vibration.

Delicates

This cycle is for washing lingerie or sheer and lacy clothes which can easily be damaged.

Speed Wash

Use the Speed Wash cycle to quickly wash lightly soiled clothing and small loads. For high wash and rinse efficiency, washing small loads of 2-3 lightly soiled garments is recommended.

NOTE: Use very little detergent in this cycle. If you want additional rinsing, you can add extra rinses by using the Extra Rinse button.

TOWELS

Use this cycle for washing towels, shirts, jeans and mixed loads.

Downloaded

If you download a cycle using a smart phone, it will be placed in the Downloaded cycle position. Choose the Downloaded cycle to run the cycle.

NOTE: The default cycle for this position is Small Load, used for normally soiled loads with just a few items. The Small Load cycle is also available to download.

CYCLE MODIFIER BUTTONS

Each cycle has default settings that are selected automatically. You may also customize these settings using the cycle modifier buttons. Press the button for the desired modifier until the indicator light for the desired setting is lit. The washer automatically adjusts the water level for the type and size of wash load for best results and maximum efficiency. Due to the high-efficiency nature of this

product, water levels may be much lower than expected. This is normal and cleaning/rinsing performance will not be compromised.

NOTE: To protect your garments, not every wash/temperature, spin speed, soil level, or option is available with every cycle. A chime will sound and the LED will not light if a selection is not allowed.

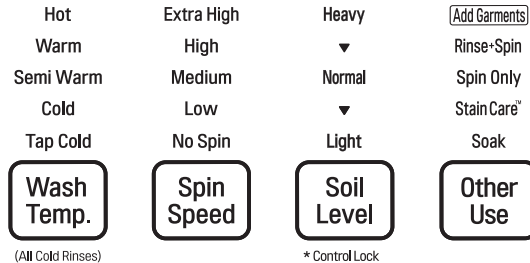

Wash Temp.

Wash Temp. selects the wash and temperature combination for the selected cycle. Press the Wash Temp. button until the indicator light for the desired setting is lit. All rinses use tap cold water.

- Select the water temperature suitable for the type of load you are washing. Follow the garment fabric care labels for best results.

Spin Speed

Higher spin speeds extract more water from clothes, reducing drying time and saving energy.

Press the Spin button until the desired speed is selected. Some fabrics, such as delicates, require a slower spin speed. To protect your clothing, not all spin speeds are available for all cycles.

Soil Level

Adjusting the soil level setting will modify the cycle times and/or wash actions. Press the Soil button until the desired soil level is selected.

NOTE: This feature needs more time for heavily soiled loads or less time for lightly soiled loads.

Other Use

Pressing the OTHER USE button will allow you to select additional features, such as Soak, Stain Care™, Spin Only, and Rinse+Spin. Pressing the OTHER USE button before selecting a cycle will automatically default to the NORMAL cycle with the Soak feature selected.

OTHER USE CARE FEATURES

After selecting a cycle, press the OTHER USE button to select additional features for the load.

NOTE:

- To protect your garments, not every feature is available with every cycle.
- If the START/PAUSE button is not pressed within five minutes to start the cycle, the control will shut off and all settings will be lost.

SOAK

This option provides a 30-minute presoak prior to the start of the selected cycle. Use the SOAK option to presoak garments to help remove difficult spots or stains on fabrics. At the end of the presoak time, the selected cycle will begin with the same water used for the soak.

NOTE: You cannot select the SOAK option for the TUB CLEAN cycle.

STAIN CARE

Use this option for heavily soiled loads that need improved stain treatment. When Stain Care is selected, the wash cycle will begin with warm water to help prevent the setting of certain types of stains. Then, as the cycle progresses, hot water will be added to gradually increase the water temperature to help remove stains that require treatment at higher temperatures.

NOTE:

- Best results are obtained with smaller loads (less Than 6 lb.)
- If you select STAIN CARE, the COLD WASH option is not available.

SPIN ONLY

Use this option to drain the water from the tub and spin out the clothes. This can be used, for example, if the wash cycle is interrupted by a power failure. The spin speed can be adjusted by using the SPIN ONLY button.

1. Press the POWER button to turn on the washer.
2. Press the OTHER USE button repeatedly until Spin Only is selected.
3. Press the SPIN SPEED button to select the desired spin speed. Selecting NO SPIN is not allowed.
4. Press the START/PAUSE button.

RINSE + SPIN

Select this option to rinse and spin a load separately from a regular cycle. This can be helpful in preventing fresh stains from setting in fabrics. You can change the spin speed by pressing the SPIN button.

1. Press the POWER button to turn on the washer.
2. Press the OTHER USE button until the Rinse+Spin indicator light is lit. (The cycle light will turn off.)
3. Press the START/PAUSE button to start the cycle.

SPECIAL DRAIN FEATURE

This washer is equipped with a special feature that is designed to make your washer as safe as possible. If the washer is paused or shut off while there is still water in the tub, the water will drain automatically after several minutes of inactivity. This helps keep children safe by reducing the possibility of water remaining in the tub.

Any water remaining in the tub will automatically drain 5 minutes after the washer has shut off. If the washer is paused and the START/PAUSE button is not pressed within 5 minutes, the washer will shut off and all cycle settings will be lost. And any water remaining in the tub will be drained.

The washer can be turned on or restarted any time before the drain begins. However, once the washer begins to drain, all controls and functions will be disabled until the water has been completely drained and the washer shuts off.

OPTION BUTTONS

Your washing machine features several additional cycle options that customize cycles to meet your individual needs. To use these options, select the desired option AFTER selecting the desired cycle.

After selecting the desired cycle and settings, press the cycle option button(s) for the option(s) you would like to add. The button will light when that option is selected. If the selected option is not allowed for the selected cycle, the chime will sound twice to alert you and the LED will not illuminate.

NOTE:

- To protect your garments, not every option is available with every cycle.
- If the START/PAUSE button is not pressed within 60 minutes to start the cycle, the control will shut off and all settings will be lost.

COLD WASH

This option saves energy by using cold water while increasing the wash and rinse times to maintain wash performance.

NOTE:

- The Stain Care feature cannot be selected with the Cold Wash option.
- Wash time will increase up to 50% with the Cold Wash option.
- For best wash results, only wash small loads (less than 8 lbs.) with the Cold Wash option.

DELAY WASH

Once you have selected the cycle and other settings, press this button to delay the start of the wash cycle. Each press of the button increases the delay time by 1 hour, for up to 19 hours. Once the desired delay time is set, press the START/PAUSE button to start the delay time.

NOTE: If the START/PAUSE button is not pressed to begin the delay time, the washer will automatically shut off after five minutes and all cycle settings will be lost.

TURBO WASH™

Adding the Turbo Wash™ option reduces the cycle time while still providing similar wash performance to the same cycle without Turbo Wash.

NOTE:

- The Turbo Wash™ option cannot be used with all cycles.
- Turbo Wash™ defaults ON for NORMAL, PRE WASH + NORMAL, and SPEED WASH cycles.

EXTRA RINSE

This option will add an extra rinse to the selected cycle. Use this option to help ensure the removal of detergent or bleach residue from fabrics. Liquid fabric softener, if used, is always dispensed in the final rinse.

NOTE: You cannot select the Extra Rinse option with the Spin Only option and Tub Clean cycle.

WATER PLUS

Use this option to add extra water to the wash cycle for better wash performance and stain treatment of large or bulky items.

NOTE:

- If the washing machine reaches its maximum water level, the WATER PLUS button will have no effect.
- The Water Plus option can only be selected or deselected while the cycle is running.
- Once the Water Plus option has been added to a cycle, it is saved as a default option on that cycle until you deselect it.
- To deselect the option, press WATER PLUS after starting the cycle.

Adding the Water Plus Option to a Cycle

1. While the cycle is running, press START/PAUSE to pause the cycle
2. Press WATER PLUS to add Water Plus as a default option for that cycle.
3. Press START/PAUSE to resume the cycle.

SIGNAL

The washing machine plays a melody when the wash cycle has finished. Press and hold the EXTRA RINSE button for three seconds to activate or deactivate SIGNAL. When no signal is heard, the signal is off. The volume settings are ON/OFF.

CONTROL LOCK

Use this option to disable the controls. This feature can prevent children from changing cycles or operating the machine. Once the CONTROL LOCK is set, it must be deactivated before any controls, except the POWER button, can be used. Once the washer has shut off, the POWER button will allow the machine to be turned ON, but the controls will still be locked. When the controls are locked, CL will display alternately with the estimated time remaining.

Press and hold the SOIL LEVEL button for 7 seconds to activate or deactivate CONTROL LOCK.

NOTE: Once the controls are locked, they must be manually unlocked to restore operation.

ADD GARMENTS

Laundry may **ONLY** be added to the load at the proper time in the wash cycle. When the Add Garments light is illuminated, it is safe to pause the cycle and add more items to the load. If garments are added when the Add Garments light is off, the washer will not adjust for these items which could result in poor performance and/or fabric damage.

1. Press the START/PAUSE button to pause the washer.
2. Open the lid after it unlocks.
3. Add your additional items.
4. Close the lid.
5. Press the START/PAUSE button. The cycle will resume after the lid locks.

NOTE:

- The ADD GARMENTS light is an indicator only and is not selected by pressing the OTHER USE button.
- If the washer remains idle for 5 minutes after pausing the cycle, the water in the tub will drain.