

READ ALL INSTRUCTIONS PRIOR TO STARTING!

TOOLS REQUIRED

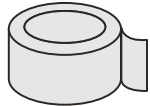

Blue Tape

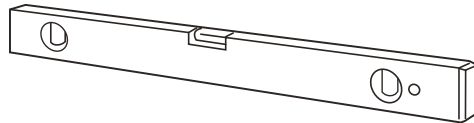

Level



Wood Glue

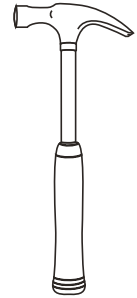

Hammer

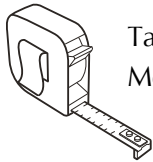

Tape Measure



Power Drill with
Phillips Head Bit

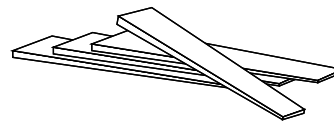

Shims

BEFORE GETTING STARTED: PRECAUTIONS

1. Please wear safety gear appropriate to tools being used. Eye protection should be used at all times. Failure to use protective eye gear can result in serious injury. **ALWAYS wear proper safety gear when operating power tools.**
2. Always ensure you have ample space to operate power tools with complete control of the power tool.
3. Door(s) are heavy and should be lifted by 2 people at all times. Mishandling of heavy objects (i.e., doors) may cause a loss of balance resulting in injury. Always take precaution in assuring proper balance before moving the door(s). Safety shoes should also be worn to prevent any foot injuries.
5. Door(s) swing on hinges which can create pinch points (hair, fingers, clothing, etc.). Take precaution when swinging.
6. Take care in not catching fingers in door opening when swinging the door closed.

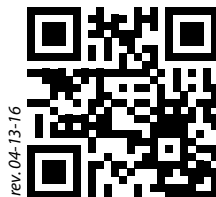

In addition to the written instructions on page 2, click on the QR code to view the assembly video

INSTALLING INTERIOR DOOR: PREHANG KIT

*** please read ALL instructions prior to assembling ***

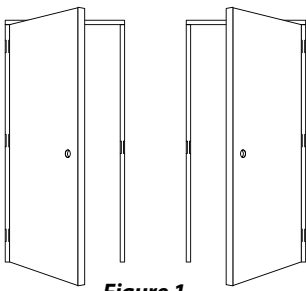

Figure 1

- 1) **Determine door handing** - Standing on the side you want the door to swing towards, establish whether hinges will be on left or right side of door (figure 1).
- 2) With door standing, apply screws in each square side of hinge with pin facing towards you (figure 2).
- 3) a. Place door on flat protected work surface (use protective blanket or pad so as to not scratch) with hinges facing down. Make sure surface is clean of any debris. Apply hinge jamb with top of jamb (end with pre-drilled screw holes) towards top of door.

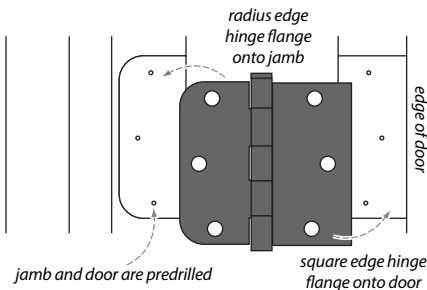

Figure 2

- b. Attach head jamb and then strike jamb using provided screws (figure 3). Make sure install channel lines up with hinge jamb. **Careful not to over tighten so as to avoid splitting the wood.**
- 4) Install door frame into opening:
 - a. Place frame in the opening.
 - b. Shim frame in opening centering as close as possible. Wood shim placement should provide plum and square alignment with even reveal between door and jambs (figure 4).
 - c. Either using screws or nail gun, attach hinge jamb side of frame making sure the screws or nails penetrate thru the shims. **Installation screws or nails should be placed in jamb channel.** Jamb should be fastened in close location to the hinges (figure 5).
 - d. Secure the head jamb and strike jamb in same fashion.

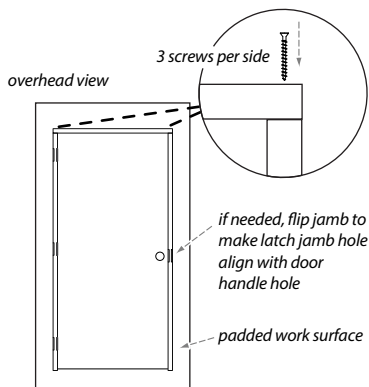

Figure 3

- 5) Install wood stops:
 - a. Once the door and frame are installed, double check operation and reveals for proper alignment (figure 6).
 - b. Using a high quality wood glue, apply small amount to head stop, insert in groove and hold with blue tape until dry (figure 7 and 8). Wipe any excess glue off immediately with wet cloth.
 - c. Repeat stop install for side jambs.
 - d. NOTE - by gluing the stops in, all nails or screws will be hidden giving the install a clean look (no filling or puttying of the installation holes).

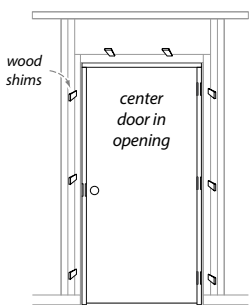

Figure 4

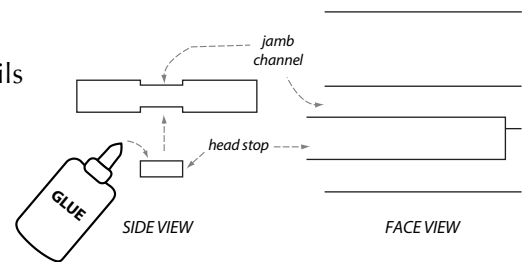

Figure 7

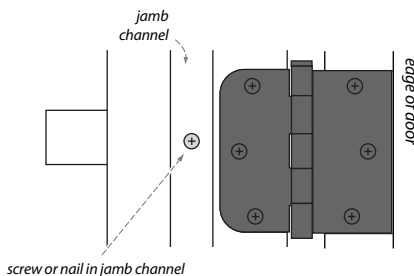

Figure 5

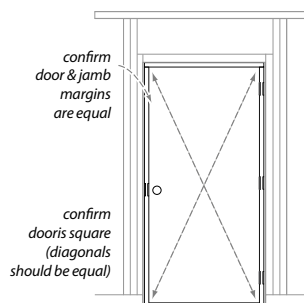

Figure 6

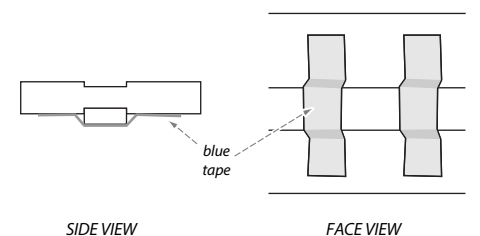

Figure 8