

Assembly Instructions

Caution : You must read this before you proceed

Table



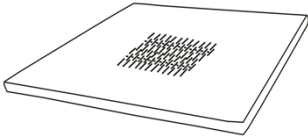
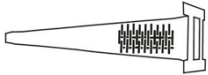

CAUTION : This Table is NOT a TOY.
Keep your child / children at bay during the assembly process.

Parts List

Label	Picture	Description	QTY
A		Woven Table Top	1
B		Table Leg	4

Hardware

Label	Picture	Description	QTY
C		Allen Key	1
D		Screw with Flat Washer Ring	16

Assembly Preparation

Before Beginning Assembly:

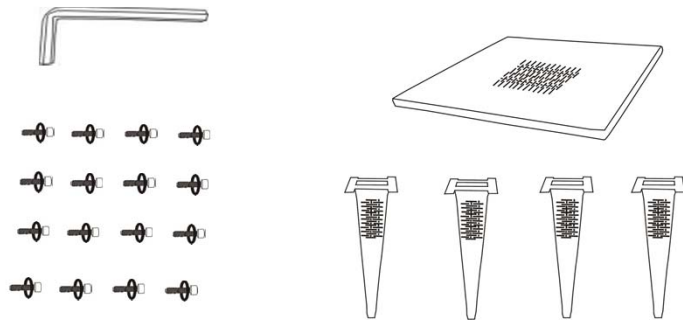

• Read instructions, cover to cover-



• Have 2 adults on hand for assembly-



• Do not assemble on flooring or carpet-



• Assemble on a clean non-marring surface (packing foam)-



• Save all packaging until finished-

Assembly Steps

Step 1

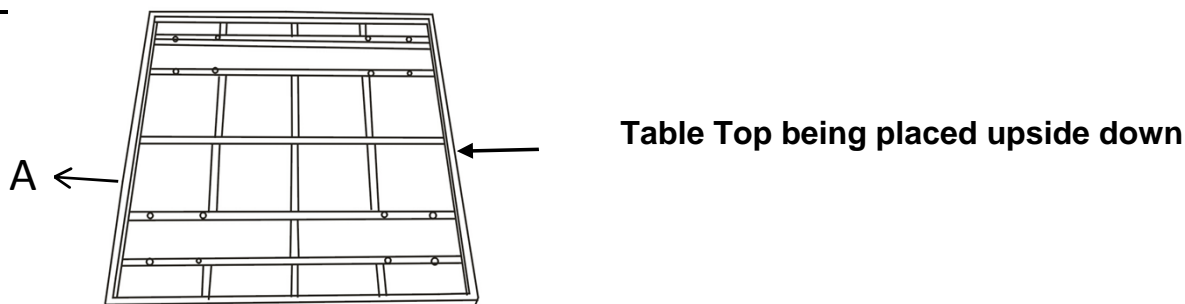

Place the Woven Table Top(A) with top facing downwards on a sofa, clean surface

Step 2

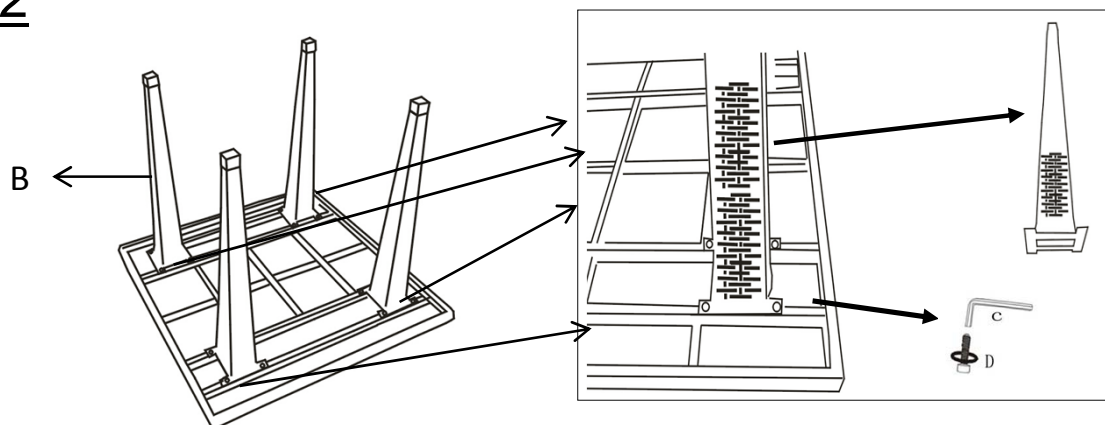

Then, place the table leg(B) over screw points

Attach the screw with Flat Washer Ring(D) onto the contact point as shown in picture. Tighten screw with the Allen Key(C).

Step 3

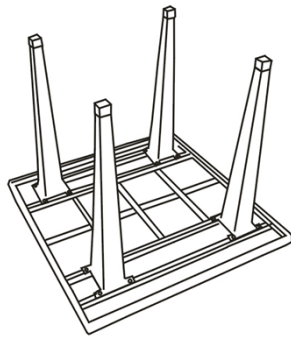





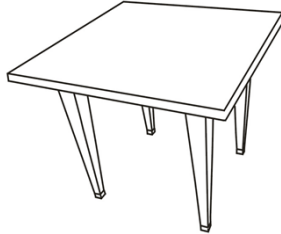













Repeat the same assembly process for the remaining three legs and respective screw points

Step 4



Turn the table **RIGHT** Side Up. Your Table is ready for use.

Care & Maintenance

-   ● Do not put **HOT** items directly on furniture surface.
 -   ● Do not clean furniture with **HARSH** cleansers or polish.
 -   ● To prolong product lifetime, **AVOID** placing furniture under direct sunlight.
 -   ● Do not place furniture near **heating or cooling** vents.
 -   ● Do not write on furniture without a padded barrier to protect the surface.
 -   ● To prolong the product lifetime, avoid extended and lengthy exposure to rain and sunshine. Where possible, place under covers and or patio and or awnings.
 -   ● For residential use only. Not for commercial use.
 -   ● Stains may be removed with mild soap solution and damp cloth.
-
-   ● Dust and pick-up spills using a clean, non-colored, lint-free cloth.

Assembly Instructions

Caution : You must read this before you proceed

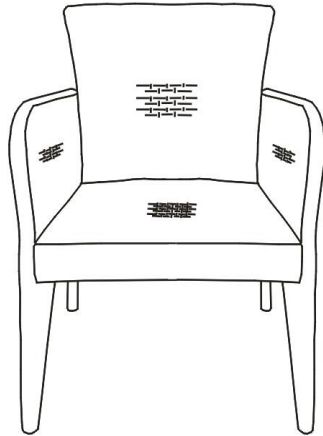

Dining Chair



Parts List

Label	Picture	Description	QTY
A	A line drawing of the backrest part of the chair. It is a rectangular panel with a curved top edge and a small circular hole at the bottom center. There are small rectangular patterns on the backrest.	Backrest	1
B	A line drawing of the left armrest part of the chair. It is a rectangular panel with a curved top edge and a small circular hole at the bottom center. There are small rectangular patterns on the armrest.	Left Armrest	1
C	A line drawing of the right armrest part of the chair. It is a rectangular panel with a curved top edge and a small circular hole at the bottom center. There are small rectangular patterns on the armrest.	Right Armrest	1
D	A line drawing of the seat panel part of the chair. It is a rectangular panel with a slightly curved top edge and a small circular hole at the bottom center. There are small rectangular patterns on the seat panel.	Seat Panel	1

Hardware

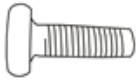
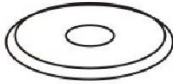
Label	Picture	Description	QTY
E		Allen Key	1
F		Bolt (M6*35MM)	5
G		Bolt (M6*20MM)	3
H		Flat Washer	8

Assembly Preparation

Before Beginning Assembly:

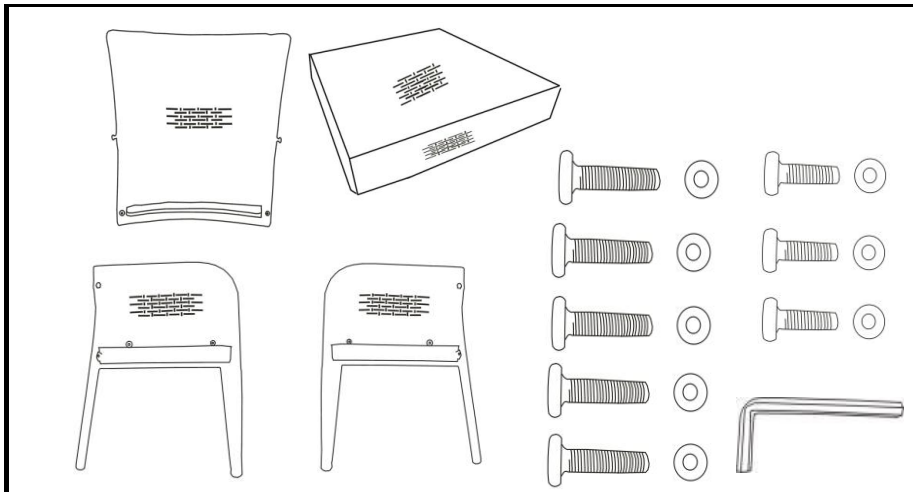

- Read instructions, cover to cover-



- Have 2 adults on hand for assembly-



- Do not assemble on flooring or carpet-



- Assemble on a clean non-marring surface (packing foam)-



- Save all packaging until finished-

Assembly Steps

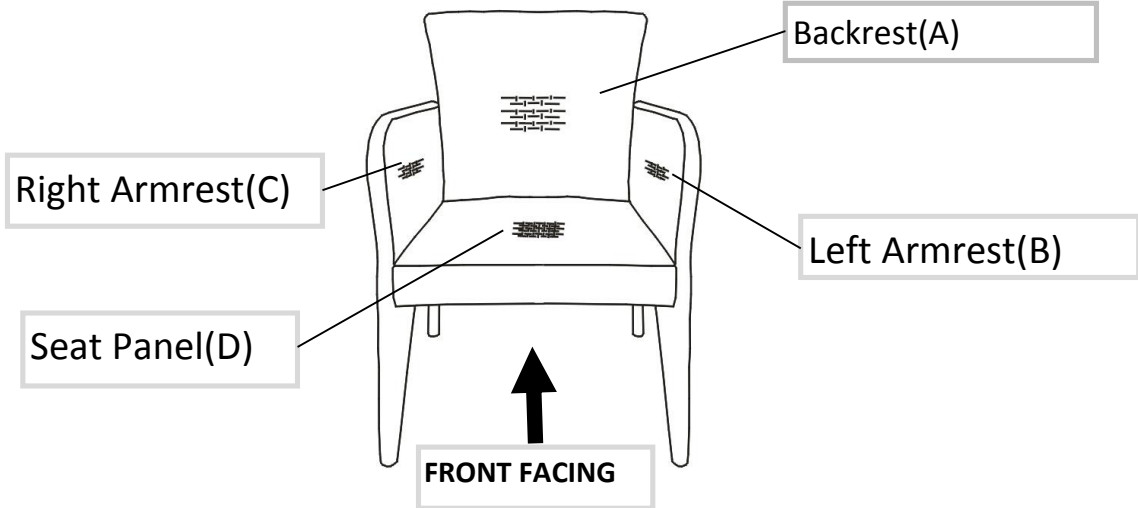

This Dining Chair has multiple parts and may require up to 45 minutes to assemble. To give you an overview of the Dining Chair parts, the above picture is to help you put the various parts into perspective. Please read through the instructions herebelow to familiarise yourself with the parts and steps before assembly.

Step 1

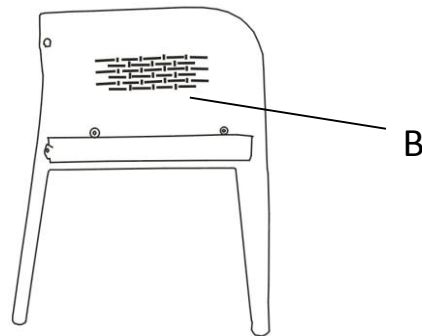

Open the carton and place all the parts onto a clean, non-marring surface, preferably a working top. Place Left Armrest(B) on the ground, as shown in picture above.

Step 2

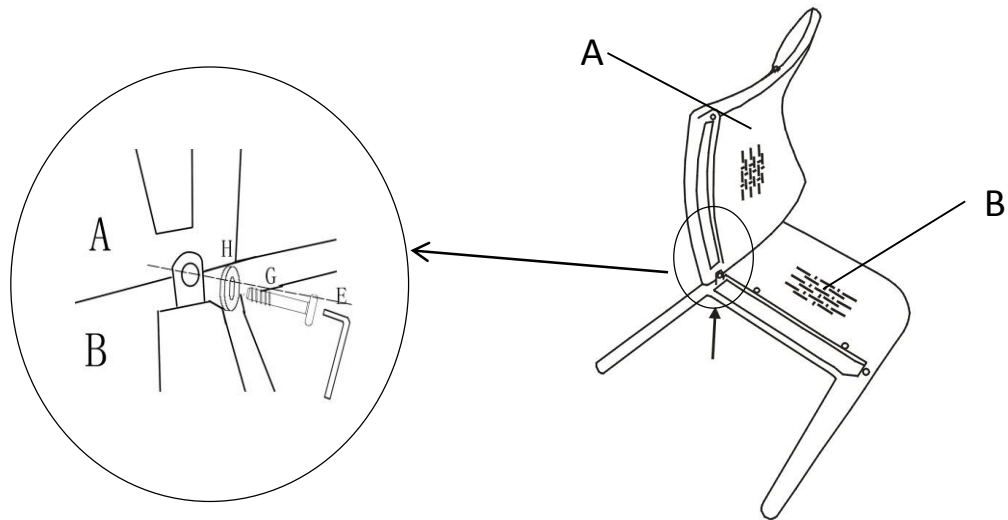

Attach and secure Backrest(A) to Left Armrest(B) using Bolts(G) and Washers(H) with Allen Key(E)
Only Loosely Tighten Bolts.

Step 3

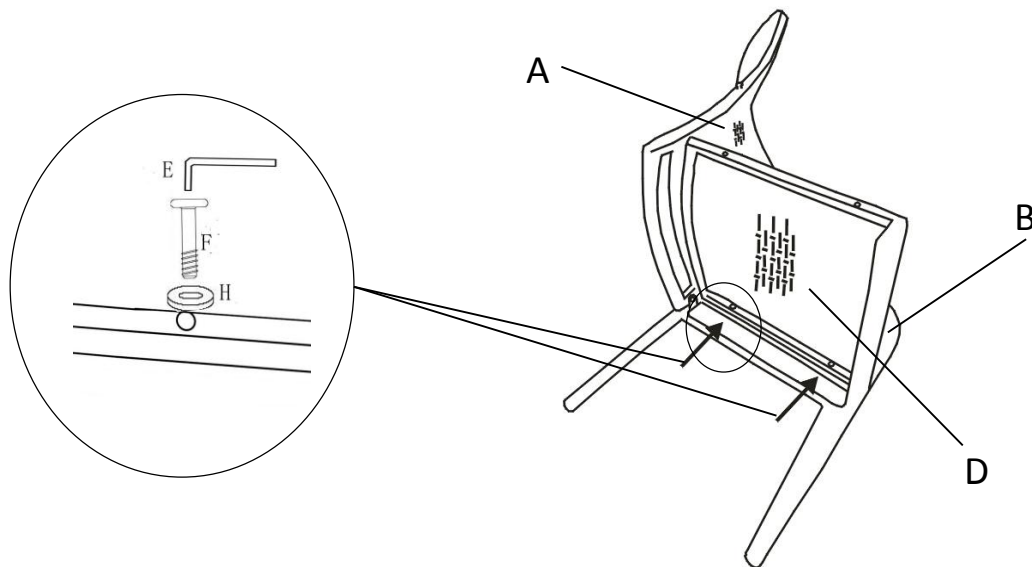

Attach the Seat Panel(D) to the assembled Backrest(A) and Left Armrest(B) using Bolts(F) and Washers(H) with Allen Key(E)
Only Loosely Tighten Bolts.

Step 4.1

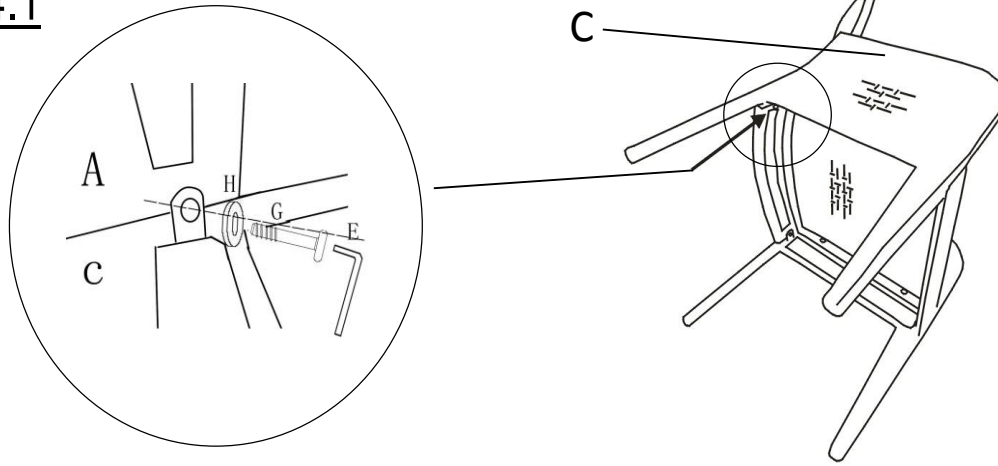

Place the Right Armrest(C) onto the mounting bolts, and secure with Bolts(G) and Washers(H) with Allen Key(E).
Only Loosely Tighten Bolts.

Step 4.2

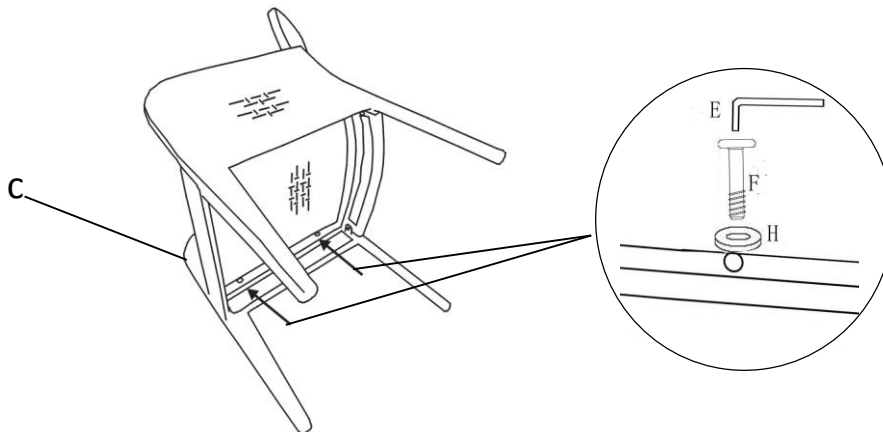

Turn the chair over, and assemble the Right Armrest(C) using Bolts(F) and Washers(H) with Allen Key(E)
Only Loosely Tighten Bolts.

Step 5

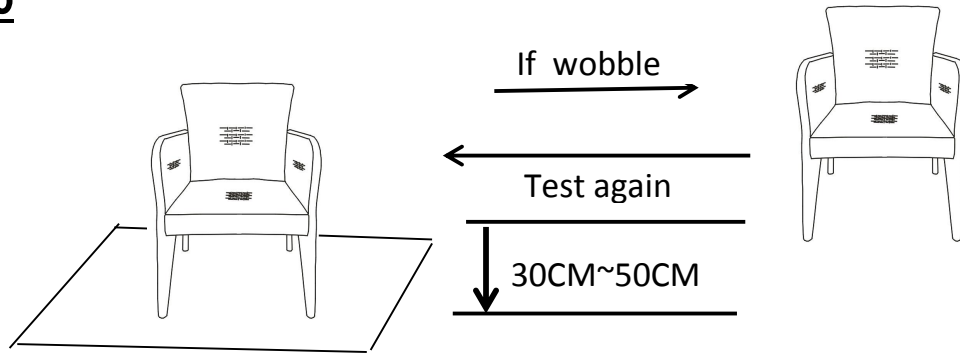

Place the dining chair on a LEVEL SURFACE to check for wobbles.

If it wobbles lift the dining chair to some 20cm to 30cm height from the ground.

Keep your feet and toes well away from the drop zone.

Drop the dining chair freely and vertically with the four legs, hitting the ground, all at the same time.

This Drop Test will help to ensure that all the bolts and gaps to all reach full alignment status.

Test again for evenness on a LEVEL SURFACE.

If no wobbles found, slowly and steadily, turn the chair upside down.

Then, proceed to tighten all bolts in a sequential manner.

CAUTION : When tightening these bolts, tighten sequentially.

DO NOT tighten any screw fully and then towards the next one.

This would cause the frame to warp.

If there is still wobbles, loosen the bolts and execute this same drop tests.

WARNING!! IF DINING CHAIR IS NOT STABLE , IT COULD LEAD TO DAMAGING THE PRODUCT.

Step 6

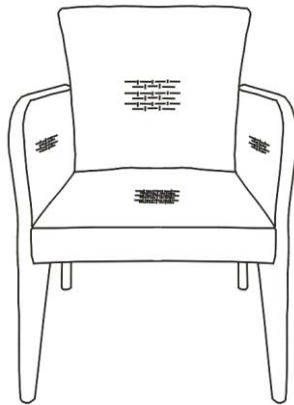

Your Dining Chair is ready for use.

Care & Maintenance



- Do not put hot items directly on furniture surface.



- Do not clean furniture with harsh cleansers or polish.



- To obtain the longest lifespan of your outdoor products, minimizing exposure to direct sunlight is recommended.



- Children should not climb or jump on the furniture.



- Do not write on furniture without a padded barrier to protect the surface.



- To obtain the longest lifespan of your outdoor products, avoid extended and lengthy exposure to rain, snow, and direct sunshine. Whenever possible cover the product and /or place under patio or awnings.



- Not for commercial use. For residential use only .



- Stains may be removed with mild soap solution and damp cloth.



- Keep away from sources of ignition.



- Dust and pick-up spills using a clean, non-colored, lint-free cloth .