

Thank you for choosing Sunnydaze Decor. We stand behind our brand and the quality of the items we sell. Replacement parts or products will be sent at our discretion within the 1-year warranty period. Proof of purchase, with the date of purchase as well as photos of the merchandise defect, must be provided. Photos are used to determine the cause of defects and for future quality control. Register your warranty at <https://tiny.cc/SunnydazeWarranty>. If you have any questions, comments or concerns, feel free to contact us by phone at 833-982-1977, by email: customerservice@sunnydazedecor.com, or via our contact us page at <https://tiny.cc/SunnydazeContact>











MODERN CHIMINEA RCM-535



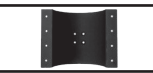

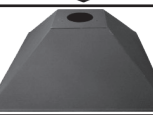



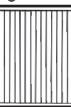

2-PERSON
ASSEMBLY

Read the assembly instructions carefully and follow the care instructions.
Save this document for future reference.

Assemble on a soft, clean surface to avoid scratching or damaging the finish.

No.	PARTS	QTY.
A	 Base	1
B	 Lower Support	1
C	 Firebowl	1
D	 Upper Support	1
E	 Flue Bracket	1
F	 Flue Base	1
G	 Hood Bracket	1
H	 Hood	1
I	 Main Flue	1
J	 Rain Cap	1
K	 Bolt	26
L	 Long Bolt	1

No.	PARTS	QTY.
M	 Washer	3
N	 Flat Bolt	5
O	 Wood Grate	1
P	 Anchor Bracket	1
Q	 Anchor Plate	1
R	 Peg	1
S	 Concrete Anchor	2
T	 Hex Key	1

⚠ WARNING

CHOKING HAZARD — This item contains small parts that can be swallowed. Keep children away during assembly.

ASSEMBLY

STEP 1

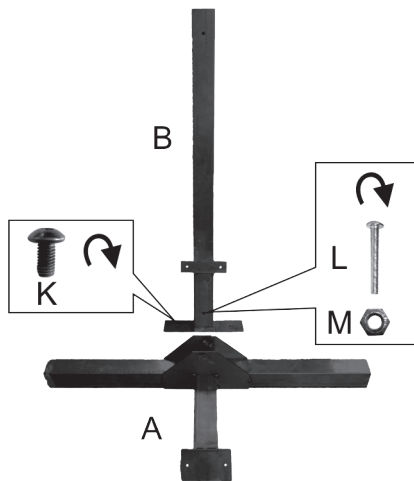

STEP 2

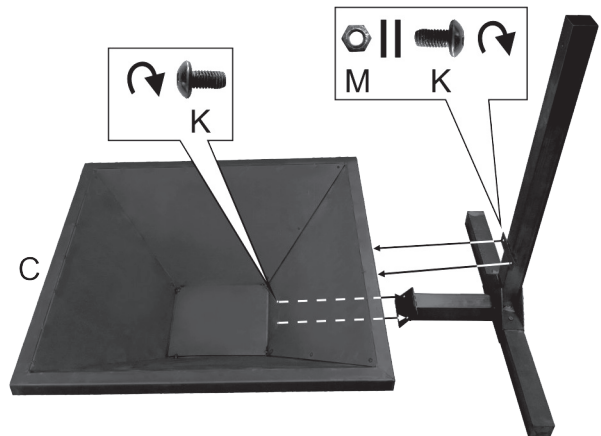

! HELPFUL HINT

Do not fully tighten hardware until all components are assembled. If hardware is tightened too soon, mounting holes may not align, and parts may not easily fit together.

STEP 3

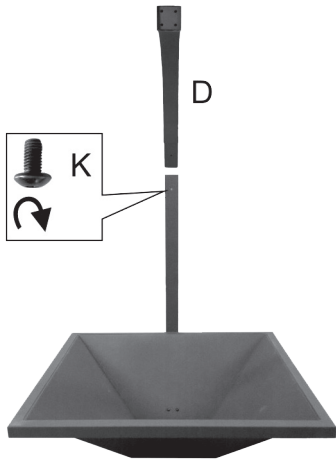

STEP 4

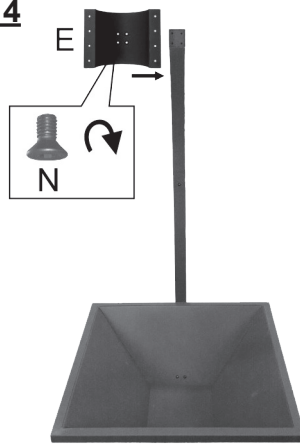

STEP 5

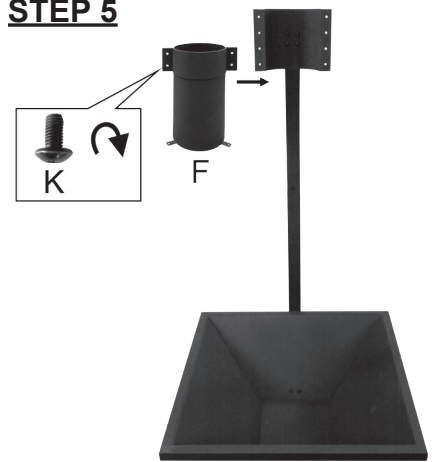

STEP 6

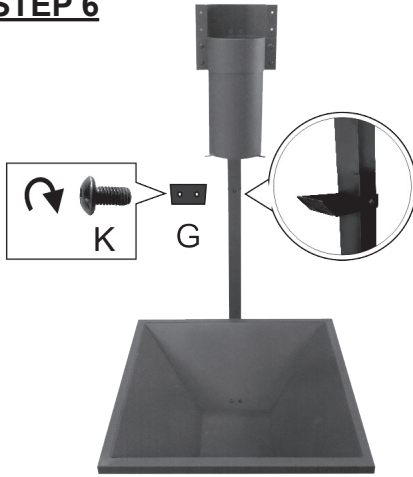

STEP 7

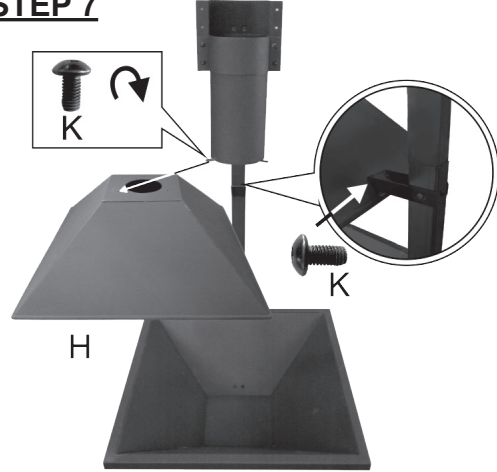

STEP 8



STEP 9

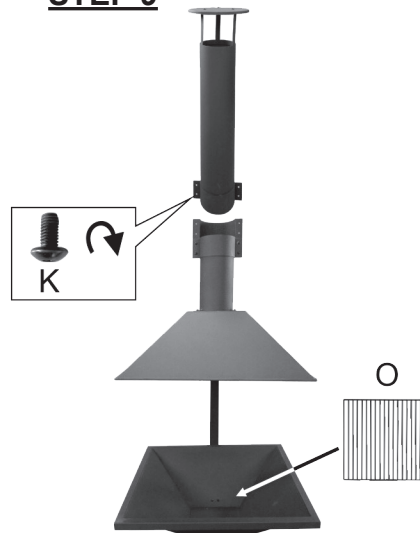

STEP 10

Anchors optional, but recommended for safety purposes

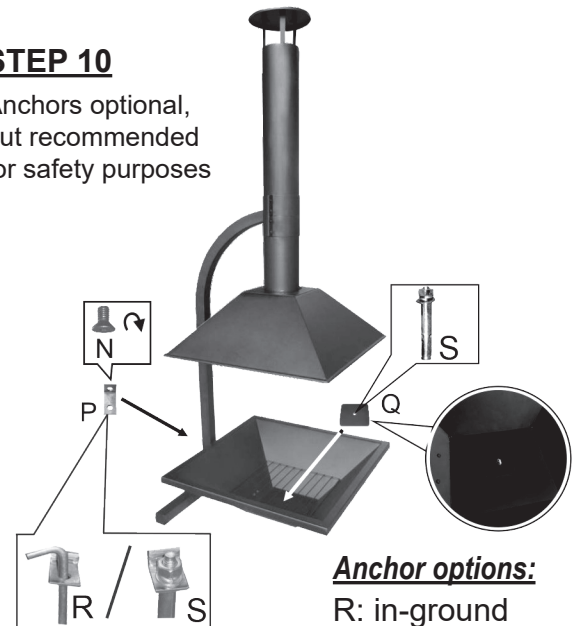

Anchor options:
R: in-ground
S: concrete

CARING FOR YOUR CHIMINEA:

Clean Regularly: All chimineas must be cleaned and inspected periodically. The ash produced in wood-burning chimineas must be cleaned out regularly. Never allow ash to accumulate in the bowl or the flue.

Clean Safely: Make sure the fire has completely died down, and the metal is completely cool before you remove the ashes and cleaning the flue.

Avoid Accelerants: Never use accelerants to start a fire; this is dangerous and can be damaging to the unit.

Avoid Plastic: Never use any plastic materials in or nearby a fire pit. It is very difficult to remove the residue later, and the burning of this residue can cause the emission of toxic fumes.

Use on a Safe Surface: Always use chimineas on a smooth, non-combustible surface; do not use on a wood deck or other combustible surfaces like dry grass, leaves, mulch, etc. Do not use chimineas near combustible structures such as vinyl or wood siding. Take care never to drop your chiminea, as any breakage could cause serious damage and costly repairs.

Cover and Store: If you do not plan to use your chiminea for an extended period of time, cover and store it in a dry location; this will protect it from the elements and dust buildup. If you decide only to cover the chiminea, be sure it is not exposed to water. The manufacturer is not liable for rust due to weather conditions.

Extinguish: Let fires die down gradually, do not use water to put out a fire as this may cause the metal to crack as a result of the sudden drop in temperature.

! SAFETY STATEMENTS & WARNINGS !

- For outdoor use only. Never use this product in an enclosed area.
- Always follow local laws and regulations when using wood-burning fire pits and chimineas.
- Exercise the same care and precautions as you would with an open fire.
- Keep unit a safe distance away from buildings, balconies, or overhangs when in use.
- Use on a level, non-combustible surface.
- Do not use on or near combustible surfaces or structures such as wood decks, dry leaves or grass, mulch, vinyl or wood siding, etc.
- Keep away from all combustible materials, including gasoline and other flammable liquids and vapors.
- Never use accelerants such as, but not limited to, gasoline, alcohol, paint thinners, kerosene. Accelerants may cause serious injury or product damage.
- The chiminea becomes very hot when in use; let it completely cool before cleaning or moving.
- Keep out of reach of children.
- Do not overfill or use this unit to burn leaves or trash.
- Avoid using any chiminea during dry or windy conditions.
- Never leave unit unattended while hot or in use.
- Supervise children and pets when the chiminea is in use.
- DO NOT USE CHEMICAL-BASED CLEANERS as this may damage the product and/or ignite a flame during the next use.
- Extinguish the fire properly before leaving. Use a fire extinguisher or a bucket of sand to smother the fire if necessary. Do not use water to extinguish hot fires or embers as this may cause serious injury and may damage the product.
- Ashes can remain hot for a long time after the fire is extinguished. Dispose of cold ashes properly.
- Ensure the unit is completely cool before covering, failure to do so will damage the cover and the unit.

Any modification to the product or failure to follow recommended care will void the product warranty.

! WARNING:

Manufacturer and seller expressly disclaim any and all liability from personal injury, property damage or loss, whether direct or indirect, or incidental, resulting from the incorrect attachment, improper use, inadequate maintenance, or neglect of this product.