



LIFETIME LIMITED WARRANTY

Covering your use of EXTRAGREEN™ wood for as long as you own your home or farm.

When used in an application which is consistent with the intended end use identified on the product label or stamp and in conjunction with a residential or agricultural structure located in the United States of America, then subject to the conditions contained in this Warranty, your EXTRAGREEN™ wood is warranted against such damage by termites or fungal decay as would make the lumber structurally unfit for the applications for which it was intended.

This warranty is good from the date of purchase for as long as you own the property on which your new EXTRAGREEN™ wood structures are built. This warranty is applicable to the original purchaser and property owner only, and is not transferable to any other property owner. The original consumer purchaser will be entitled to be reimbursed for the actual, reasonable cost of new EXTRAGREEN™ wood which is purchased to replace wood which was made structurally unfit by damage due to termites or fungal decay. To obtain the necessary prior approval for, and make arrangements for, this reimbursement, the original owner must send sufficient amount of EXTRAGREEN™ wood was originally purchased to cover the number of board feet claimed to be damaged, to the Warrantor, at:

EXTRAGREEN™ WOOD • Warranty Claim Administrator
L.D. McFarland Company
P.O. Box 1496 • Tacoma, WA 98401-1496

When making any warranty claim you may be required to send photographs and/or pieces of damaged wood. In addition, at the Warrantor's request, the Warrantor and its representatives and agents must per permitted to inspect and test the damaged structure.

Warrantor shall not be liable hereunder for damage to EXTRAGREEN™ wood resulting from any case other than termites or fungal decay, or for any damage to wood which has been used in a structure outside of the U.S.; used in foundation systems (such as the Permanent Wood Foundation, and piling, pole or heavy timber type residential construction); used in swimming pool sidewalls; used as fence posts, vineyard stakes or tree supports in agricultural applications; used where immersed in salt water; used for commercial or industrial projects; used in commonly owned property and structures such as condominiums; or used for and application or in a way that is not consistent with the end use identified on its original label stamp.

Warrantor shall not be liable for any installation, repair, construction, labor or similar costs, or for any costs or damage which may be associated with the natural characteristic of some wood to split, crack, warp, or twist. To the maximum extent permitted by applicable law, in no event shall Warrantor be responsible for any direct, indirect, incidental, consequential or financial damages or expenses of any kind whatsoever, howsoever caused (whether or not due to any deficiency or negligence in manufacturing, and whether or not relating to loss, damage, death or injury) arising out of or relating to your purchase or use of EXTRAGREEN™ wood.

For hem-fir, Douglas fir, and western hemlock, this warranty is null and void unless all cut ends and bore holes were properly coated at the time of construction with a suitable wood preservative, such as EXTRAGREEN™ End Cut Solution, containing a minimum of 1% copper. Proof of purchase of the preservative is also required. These species are covered by this only when used in the states of Alaska, Arizona, California, Colorado, Idaho, Montana, Nevada, New Mexico, Oregon, Utah, Washington, Wyoming and Hawaii (except for unincised decking which does not meet AWPA recommended standards, which is specifically not warranted by Warrantor in Hawaii).

By purchasing EXTRAGREEN™ wood you accept this Warranty and hereby acknowledge that this replaces all other representations, warranties, guarantees, terms, covenants, agreements, promises, commitments, duties of care or conditions ("Representations"), expressed or implied, statutory or otherwise, indulging, quality or suitability, and there are no Representations whatsoever with respect to EXTRAGREEN™ wood except the specific warranty given hereunder. Only the Warrantor is liable under this Limited Warranty and the directors, officers, employees and agents shall have no liability of any kind to you or others with respect to your purchase or use of EXTRAGREEN™ wood.

SLO204



BUILDING THE DECK OF A LIFETIME



BUILDING FENCES WITH EASE

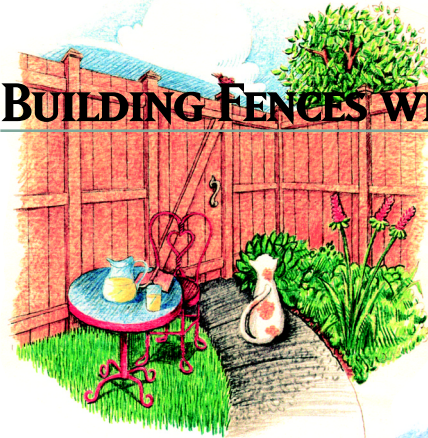

LANDSCAPING WITH TIMBERS



ADDITIONAL PRODUCTS



INTRODUCTION

A deck is one of the most versatile and valuable additions you can make to your home. A well-made deck is great for entertaining or for quiet family living, for showcasing a beautiful yard or for hiding sloped or barren land.

Building your deck yourself makes good sense. It is a money-saving and simple project which requires very few basic skills and tools.

ABOUT THIS BOOK

The following four sections in this brochure will guide you in planning, designing and building a basic deck, fencing, and landscaping with timbers.

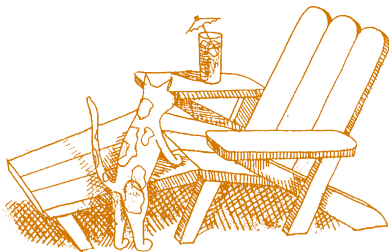

Great Decks: The Right Plan, The Best Lumber



Designing the deck, choosing the type of lumber to use and compiling a materials list are three essential steps to building your own deck. In this brochure, you will learn how to plan, design, build and maintain a basic deck. You will also learn to add railings and stairs, as well as other advanced decking techniques. With the proper preparation, the right tools and wood from McFarland Cascade®, you'll be well on your way to the deck of a lifetime.

Getting Down To It



Building a deck is easy if you follow the Six Steps to Building a Basic Deck listed in this section.

Advanced Construction Techniques



For help in adding accessories such as railings and stairs to your deck, or for other advanced construction tips, turn to this section.



Consumer Information, Tips and Warranty

Read this section for further information about handling treated lumber and about general construction and maintenance.

GREAT DECKS: THE RIGHT PLAN, THE BEST LUMBER

Careful planning is essential for your deck-building project to be a success. There are three steps to the planning process: Designing the Deck, Choosing the Type of Lumber to Use and Compiling a Materials List.

Designing the Deck

Designing your deck can be almost as much fun as building and owning one. You can take a stroll through your neighborhood for ideas, read books and magazines, or just sketch out what you have in mind. It's fun being creative, and there is no math involved in this stage – just your imagination.

McFarland Cascade® Deck Lumber: The Obvious Choice

Choosing the right kind of lumber to use for your deck is essential, fortunately, it is also the easiest decision you'll make in building your deck.

Which Kind of Lumber Is Best For My Needs?

Whatever your requirements, McFarland Cascade® has a product that will meet them, whether your concern is for appearance, strength or cost.

McFarland Cascade® offers treated framing lumber options (the lumber used in the support and substructure of your deck) and a variety of decking lumber (the lumber used for the deck surface, stairs and railings) to suit your needs. Use the charts on the next page to determine which framing and decking products to order.

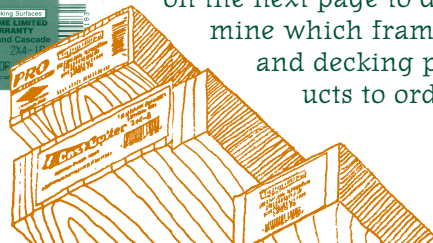

TREATED FRAMING LUMBER OPTIONS

Product Choices	Color	Visual Grade	Unique Characteristics
Construction Select™	Cedartone®	Premium-extra sort	Premium visual grade/ 2" kiln dried prior to treatment to attain greatest dimensional stability
Pro-Framing™	Cedartone®	Regular sort	Designed for professional installers
Cost Cutter®	Cedartone®	Economical sort	McFarland's least expensive option

(Note: All above items are treated to .21 CA for in-ground contact)

TREATED DECKING LUMBER OPTIONS

Product Choices	Color	Visual Grade	Unique Characteristics
Outdoor Select®	Cedartone®	Premium-extra sort	Premium visual grade
Pro-Decking™	Cedartone®	Regular sort	Designed for professional installers
Douglas Fir Decking	Cedartone®	Premium and regular sort	Highest structural rating

What You Need and How Many: A Materials Worksheet

Key Measurements

First, refer to your deck design and to the adjacent illustration. Then record your deck's measurements below. You will use these measurements to compile your materials list.

Deck Length (along the house): _____ ft.

Deck width (out from the house): _____ ft.

Deck height (distance from ground to top of decking): _____ ft.

You may need to use the worksheet on the right to determine the following values

Joist span (distance from house to center of beam): _____ ft.

Joist spacing (distance between joist centers): _____ ft.

Beam span (distance between post centers): _____ ft.

Now, you will use these measurements to compile your materials list.

Note: The following tables are based on a live load of 60 pounds per square foot. If your building code permits design with lighter loads, spans may be longer. In this case, or if your deck will experience heavier loads, consult an engineer or your lumber dealer for design assistance.

In the equations below, round all fractions to the next highest whole number.

Deck Boards

1. First, use the equation below to determine how many lineal feet of decking lumber you will need.

For 2x4 decking:
 (deck width in inches ÷ 11")
 X (3 x deck length) = _____ lin. ft.

For 2x6 decking:
 (deck width in inches ÷ 11")
 X (2 x deck length) = _____ lin. ft.

McFarland Cascade® — Materials for All Outdoors

When you've prepared a sketch of your new deck (refer to the illustration materials worksheet on this page for measurements) we will assume that the deck will be attached to the house and that you will be using treated hem/fir lumber. This worksheet is for a deck with no railing or stairs. See "Advanced Decking Techniques" for information about these sometimes necessary items.

Joists

1. Locate your deck's joist span in the table below; this will determine your joist size and spacing.

Joist Spacing	Joist Size			
	2x6	2x8	2x10	2x12
12"	up to 9'	9'-12'	12'-16'	16'-19'
16"	up to 9'	9'-12'	12'-14'	14'-18'
24"	up to 8'	8-10'	10'-13'	13'-16'

Note: All 5/4" decking must use 12" joist spacing.

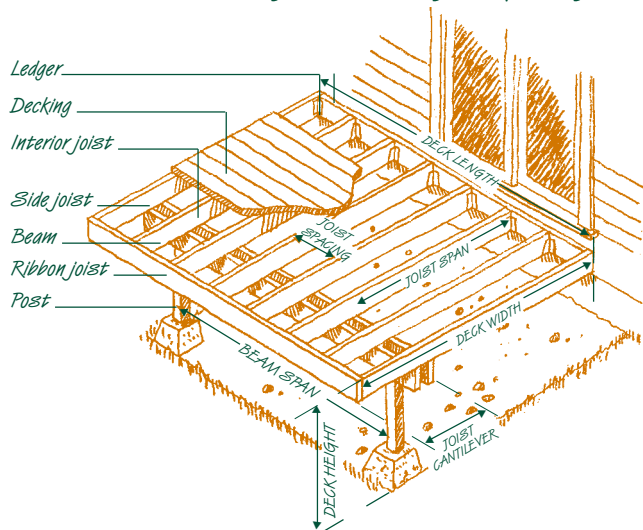

Joist size: _____ by _____

Joist spacing: _____ in.

2. Now, use the equation below to determine how many interior and side joists you will need.

For 16" joist spacing:
 (deck length X .75) + 1 = _____ joists

For 24" joist spacing:
 (deck length X .5) + 1 = _____ joists

3. The lengths of your joists will be as follows:
 Interior joist length: deck width - 3" = _____
 Side joist length: deck width - 1 1/2" = _____

4. You will also need one ribbon joist.
 Ribbon joist length
 (same as deck length): = _____

Beams

1. Decide whether you will be using a single or double beam (see Attach the Beam on page 6 for details). Then use the following table to determine the beam size, the number of boards per beam (in parentheses) and the maximum allowable cantilever.

	Joist Size			
	2x6	2x8	2x10	2x12
Single Beam	4x6	4x8	4x10	4x12
Double Beam	(2) 2x6	(2) 2x8	(2) 2x10	(2) 2x12
Cantilever	1.00'	1.33'	1.67'	2.00'

Beam size: _____ by _____

#of boards: _____

Maximum cantilever : _____ = _____ ft.

2. Beam length (same as deck length): = _____ ft.

3. Now use the table below to determine your maximum allowable beam span.

Joist/ Beam Depth	Deck Width						
	6'	7'-8'	9'-10'	11'-12'	13'-14'	15'-16'	17'-19'
6"	6.5	6					
8"	8.5	7.5	7	6			
10"	10	9	8	7.5	6.5	6	
12"	11.5	10	9.5	8.5	8	7.5	7

Maximum beam span: _____ = _____ in.

Posts

1. First, use the equation below to determine how many posts you will need. Note: If your deck will have more than one beam, multiply the total below by the number of beams.

of posts:
 [(deck length - 2 x cantilever)
 ÷ beam span] + 1 = _____ posts

2. Then, use the equation below to determine your post spacing.

Post spacing:
 $(\text{deck length} - 2 \times \text{cantilever}) \div \# \text{ of posts}$
 = _____ ft.

3. Finally, determine the proper trimmed length of the post.

Length of post: deck height + depth
 post will be buried - 1 1/2"
 = _____ ft. _____ in.

Note: The untrimmed post must be at least this long, and should be longer to allow a margin for error.

Ledger Board

1. You will need one ledger board. Below, determine its size and length.

Ledger size (same as joist size): = _____ by _____

Ledger length: deck length - 3" = _____ ft.

Hardware *(Galv ASTM A 153 [Fasteners] and ASTM A 653 Class G [Connectors])

1. Joist hangers with nails:
 # of interior joists = _____

2. Bolts (1/2" x 4" lag w/washer)*:
 For ledger:
 # of interior joists X 2 = _____

For double beam:
 # of posts X 4 = _____

Total bolts = _____

3. Nails*:
 For joist: # of joists X 5 = _____

For single beam: # of posts X 12 = _____

Total 16d nails = _____

For decking*;
 with 16" joist spacing:
 $6(\text{deck width in inches} \div 11")$
 $\times [(.75 \text{ deck length in feet}) + 1]$
 = _____

with 24" joist spacing:
 $6(\text{deck width in inches} \div 11")$
 $\times [(.5 \text{ deck length in feet}) + 1]$
 = _____

Total 12d nails = _____

Note: We highly recommend using corrosion-resistant deck screws. Do Not Mix the use of Hot Dipped Galvanized and Stainless Steel. Aluminum should not be used in direct contact with EXTRAGREEN™ treated wood.

4. Post/beam connectors (for single beam):
 # of posts = _____ connectors

Miscellaneous

1. One quart end-cut solution.
2. One gallon water repellent for every 150 sf of decking surface.

Also, remember to add fascia, pier blocks, concrete/post brackets, angle brackets, concrete and gravel as required.



GETTING DOWN TO IT

Six Steps to a Basic Deck

Deck Support

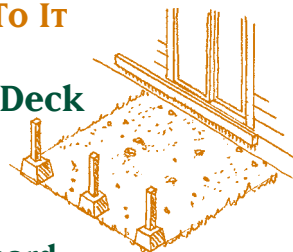

1 Install the Ledger Board

2 Position Your Footings

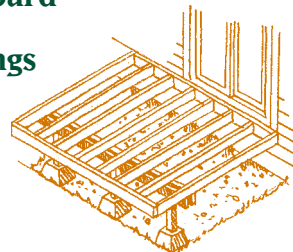

3 Install Your Posts

Substructure

4 Attach the Beam

5 Install Your Joists

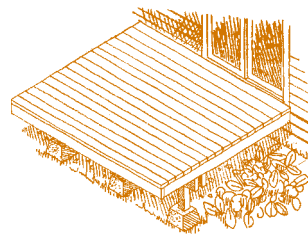

Decking

6 Lay Down Your Decking

Before beginning to build a deck, you may need to apply for a permit – check with your local building department for this and other code considerations.

Also see Consumer and Warranty Information Section before beginning any construction.

Now, let's go build a deck!

1. Install the Ledger Board

In This Step: you will prepare a flat surface on your house and will secure a ledger board to it; this will support the interior and side joists of your deck.

Tools: framing square, tape measure, level, chalk line, circular saw, pry bar, caulking gun, hammer, drill with 5/16" bit, socket wrench.

Materials: ledger board, joist hangers with hanger nails, caulk, flashing, framing nails. 1/2" x 4" lag bolts

Considerations: Length of ledger board = deck length minus 3"

Length of flashing = deck length

Using a framing square, mark joist hanger positions on the ledger board.

The ledger board must be attached to a flat surface at a height 1 1/2" below the interior floor height. Snap a level chalk line 1 1/2" below the door threshold or, if there is no door, 1 1/2" below the interior floor height. (For aluminum/vinyl siding: cut or pry away any siding below the chalk line to expose the rim joist of the house. Install an L-shaped piece of metal flashing under the siding and over the ledger board).

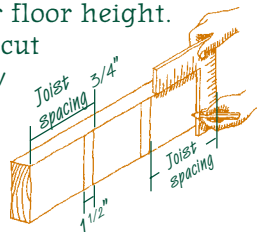

Nail the ledger board temporarily in place, the top flush with the chalk line. Since the ledger board will be supporting much of the deck's

weight, it is necessary to attach it securely to the house. Drill two holes at each midpoint between joist hanger marks, then permanently secure the ledger board to the rim joist with lag bolts. Add flashing and caulk.

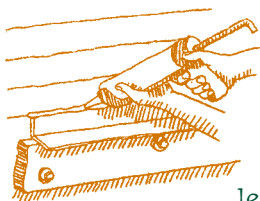

Now that the ledger board is in place, you can install the joist hangers, using a scrap piece of joist to determine the proper height of each joist hanger.



2. POSITION YOUR FOOTINGS

In This Step: you will be using string and a tape measure to make sure that your posts and footings are correctly positioned. This will ensure that the deck itself will be square with the house.

Tools: tape measure, hammer, plumb bob

Materials: nails, stakes/batter boards, string

Considerations: Cantilevering — setting in your footings — hides your posts from view and gives your deck a "floating" appearance.

From your deck design, you know how far from the house you want your posts and beam to be. Run a string line (A) on stakes parallel to the house at that distance. Example: for a 10' long deck with a 2' overhang, you would run your line 8' from the house.

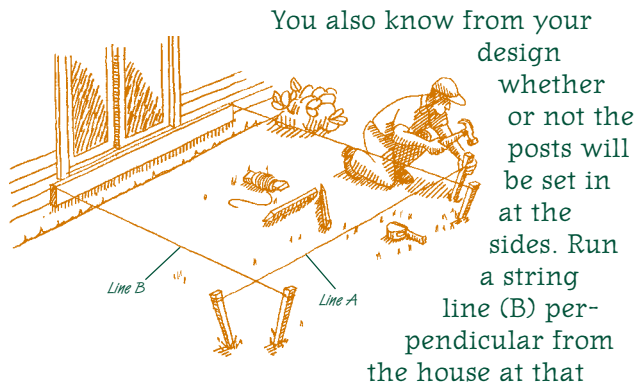

Example: for a 10' wide deck with 1' overhang on each side, you would start your line 4' out from the midpoint of the ledger board.

Square the positions where A & B cross by comparing diagonal lengths. Once the dotted lines in the diagram are the same length, your footings will be square. Mark your footings by dropping a

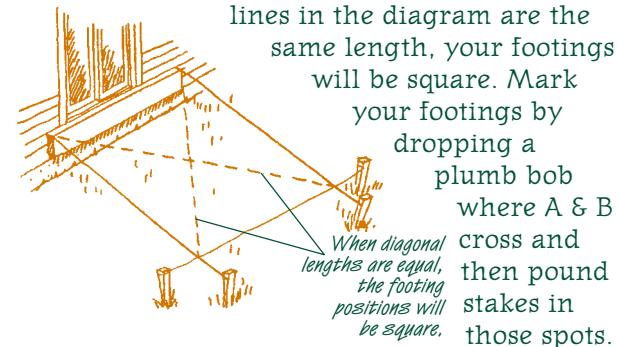

plumb bob where A & B cross and then pound stakes in those spots.

3 INSTALL YOUR POSTS

In This Step: you will install the posts, either on pier blocks or in the ground.

Tools: post-hole digger, shovel, wheelbarrow, level, hammer

Materials: ready-mix concrete/pier blocks, posts, stakes/braces, block and post connectors with nails

Considerations: Pier blocks or post-holes? Using pier blocks is easy and effective for decks less than 3' high; over patios or hard, rocky soils; where ground is level; and in colder climates.

Post-holes are sturdy, and can be used practically anywhere.

Using Pier Blocks

Set them on level, stable ground. Then secure the posts to them with any of several types of connectors, making sure to check posts for level.



Using Post-Holes

Dig holes at your footing positions that are at least 2' deep and are below the frost line.



For harder, rockier soils and in colder climates, pour a bed of gravel into the hole, place a block of treated wood on the bed, insert the post, level it, and fill the hole with layers of earth and gravel, tamping frequently and leaving a mound at the top for drainage.

For sandy soils, insert the post in the hole, level the post and fill hole with concrete. Brace the post if necessary and pour additional concrete to form a mound for drainage.

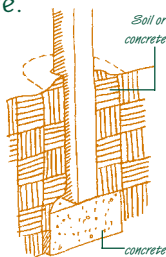

Note: In extreme frost heave conditions, sonotubes may be required when installing posts—consult your local building codes.

4 ATTACH THE BEAM

In This Step: you will either lay a single beam on top of the posts or you will attach a double beam to the sides of the posts.

Tools: pencil, framing square, tape measure, hammer, circular saw or hand saw, drill with long 1/2" augur bit

Materials: beam board(s), framing nails, 1/2" x 4" lag bolts for double beam or post to beam connectors with nails for single beams

Considerations: Single or double beam?

Whether to use a single or a double beam is largely an aesthetic decision; however, double beam boards are generally more available, and are easier to install.

Length of beam = deck length

If the deck length exceeds the length of your beam board(s), make sure that each splice is located at a post. Use connector plates and bracing to keep the splice from shifting.

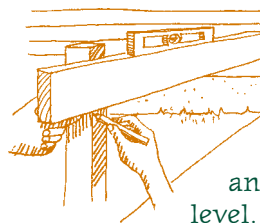

Transfer the joist hanger height to the posts using a joist and level, or by using string and a line level.

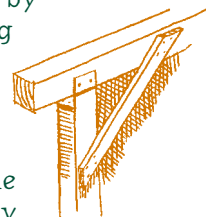

Installing a Single Beam

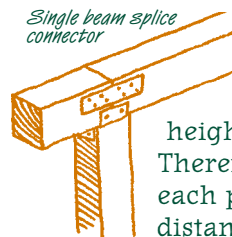

Single beam splice connector

Since a single beam will lay on top of the posts, you will need to subtract the height of the beam from the posts. Therefore, make a second mark on each post below the first mark at a distance equal to the height of the beam. Then cut the posts at the second mark. Set the beam on top of the posts and attach with connectors and nails. Single beams are more susceptible to swaying, so use bracing wherever possible.

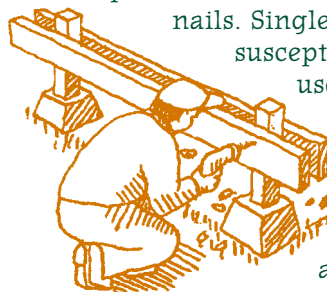

Installing a Double Beam

A double beam assembly uses two

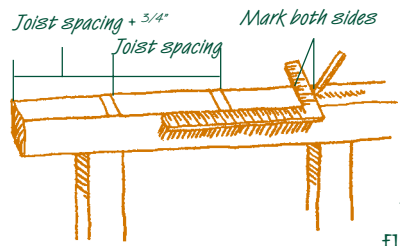

boards which "sandwich" the posts. Place the top of the beam boards flush with the mark and nail temporarily.

Drill two pilot holes through each side of post and beam boards, then secure the entire assembly with lag bolts.

Cut the posts with a hand saw, using the beam as a guide.

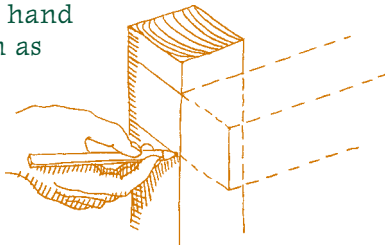

Once the beam is installed, use a framing square to mark where the interior joists will sit on the top of the beam.

DOUBLE BEAM CONNECTION DETAILS

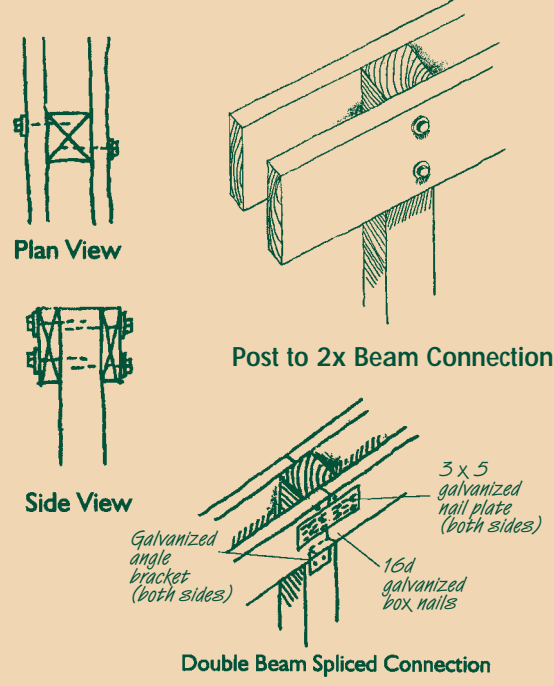

5 INSTALL YOUR JOISTS

In This Step: you will complete the substructure of your deck. Side, ribbon and interior joists will provide a nailing surface for the decking.

Tools: hammer, framing square, circular saw, tape measure

Materials: joists, framing nails

Considerations: Length of side joist = deck width - 1 1/2"

Length of ribbon joist = deck length

Length of interior joists = deck width - 3"

Crown Side Up: each joist will have a slight bow or curve along its vertical length — the "crown." Always install your joists crown side up, so that the weight of the decking will straighten the board rather than bow it further.

Side Joists

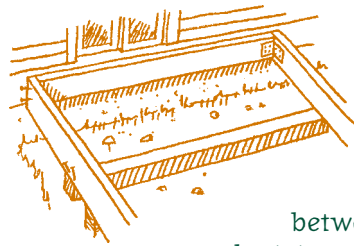

Nail into the edge of the ledger board, toenail into the top of the beam, then use an angle bracket to secure the connection between the ledger and the joist.

Ribbon Joist

Nail into the side joists, then use a framing square to mark where the interior joists will be attached.

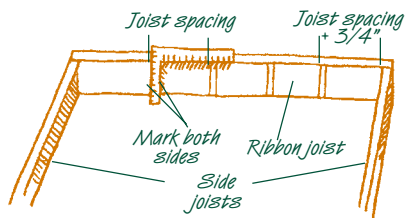

Note: At this point, with the dimensions of the deck apparent, and before you install the interior joists, you may wish to lay black plastic or weed fabric on the ground below the deck, to keep undergrowth from pushing up through the decking.

Interior Joists

To make sure that the interior joists are straight and square, use the following steps:

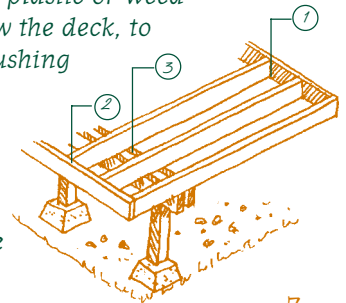

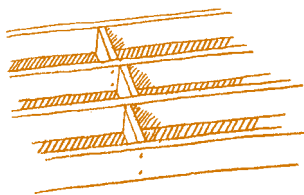

1. Nail into the joist hanger.

2 Nail to the ribbon joist, flush with the top.

3. Align with marks on the beam and toenail in place This will minimize bowing

Note: If the distance between the ledger and the beam exceeds 6' use blocking to keep the joists aligned.

6 AND LAY DOWN YOUR DECKING

In This Step: you are almost finished! Install the decking boards, trim them and add fascia for a great, finished look.

Tools: hammer, tape measure, nail set, chalk line, circular saw

Materials: bumper board, decking boards, framing nails/ deck screws, water repellent

Considerations: *Bark Side Up:* lay each decking board so that the grain pattern of the end of the board looks like a rainbow. Why? Because if the board warps over time, it will follow the grain, and will therefore shed water rather than cupping to hold it.

Crown Side Out: lay each decking board so that the crown side is out - away from the house. Why? Because you can straighten the board by nailing each end, using a pry bar to force the middle of the board back toward the house until the crown is gone and then nailing it in place.

To reduce splitting of the decking while nailing, blunt the nail points with a hammer, predrill your nail holes or use deck screws. To avoid denting the surface of the boards, you may wish to use a nail set.

Attach a bumper board to one of the side joists to form a lip against which you can butt your decking boards.

Start laying the decking from the house side, and use nails or shims to

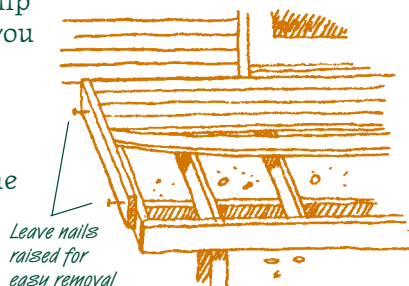

space the boards slightly for drainage (no more than 1/16" for wet decking, 1/8" for dry). As you proceed across your deck, measure the distance remaining and alter your spacing in order to avoid a large gap at the end.

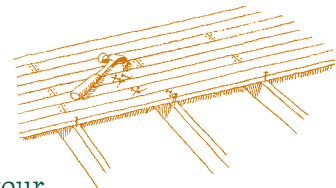

Secure the decking boards at each place where they cross a joist, using two nails or screws for 2x4's and three nails or screws for 2x6's. When using boards shorter than the deck length, make sure all board ends rest on a joist, and use different board lengths in order to stagger the splices.



When all of the decking has been secured, remove the bumper board from the side joist and snap a chalk line across the decking on the other side. Use this chalk line to trim the decking boards flush with the side joist. Use a circular saw for this task and adjust the blade depth to cut just the decking, not the side joist. Apply end-cut solution to all cut ends.

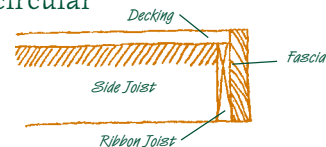

If desired, you may add a fascia to the side and ribbon joists for a finished look.

Then apply a layer of quality water repellent to all decking and exposed wood. Now your deck is complete!

Maintenance Tips

- No maintenance is needed to renew resistance to fungi and termites. EXTRAGREEN™ wood has a lifetime limited warranty against these organisms.
- To help protect your project against moisture damage, apply an effective brand of water repellent as soon as your project is finished or, for large projects, as sections are completed.
- Water repellent should be re-applied every year or two.
- To revitalize a dingy appearance caused by dirt, mildew and mold, use deck brightener to clean the wood.



ADVANCED DECKING TECHNIQUES: RAILINGS, STAIRS AND OTHER FANCY STUFF

Installing Railings

Railings enhance the beauty and safety of your deck. They can be simple or very elaborate – the variety of styles is almost endless. Railings are required for decks above a certain height; check your local building codes for this information.

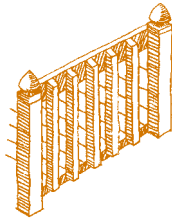

Railing Construction Tips

- Install your posts, then your top rails, side rails and finally your rail cap.
- Use lag bolts to attach the main posts to the deck.
- Make sure the top of the railing will be at least 36" high; some building codes require higher railings.
- You may bevel the tops of your balusters if they are not covered by a rail cap.
- ICBO code requires a maximum spacing of less than 4" between railing components.

Railing Styles

Rail-A-Deck®: Fast, Easy and Attractive McFarland Cascade® now offers Rail-A-Deck®, a railing system that eliminates much of the cutting and measuring involved in building a railing.

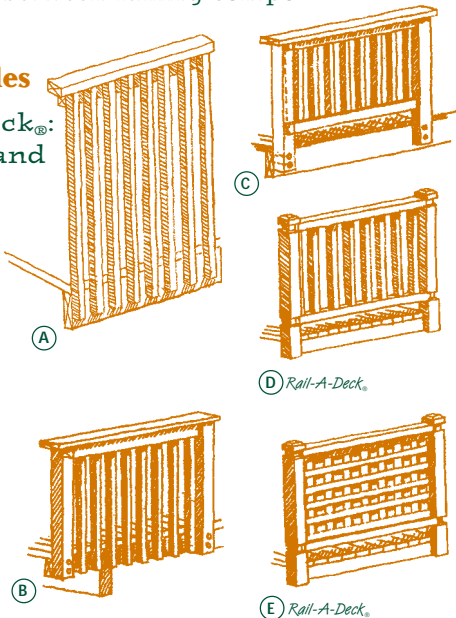

All of the Rail-A-Deck® lumber has been treated, stained and is backed by our lifetime limited warranty against decay and termites.

Also available from McFarland Cascade® are lattice panels and a variety of attractive cedar, copper and patina post caps.

5 Main Components of Rail-A-Deck

2 x 4 Rail - Interchangeable top and bottom rail combines the naturally inherent stability and beauty of cedar with the termite-proof, no-rot practicality of EXTRAGREEN™ pressure treating.

31"/36"/48" Balusters - Finely machined, tight grain, precision trimmed hemlock assures a lifetime of beauty and service.

31 1/2" x 96" x 7/8" Lattice Panel - Inserts inside 2x4 rail top and bottom. Double stapled. Spacing of lath automatically insures code compliance. May be cut to length with radial saw as needed. Fast and easy to install.

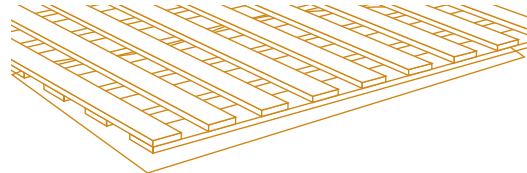

4 x 4 x 53 Deck Post -



4 x 4 x 48 Newell Post -



All components have Lifetime limited warranty against rot and termites.

Post Caps Styles



Copper High Point
Patina High Point



Copper High Plateau



Colonial Acorn



High Pyramid



Cascade Peak



McFarland Flat



Suburban
Pyramid



Ball Cap



Flat Cedar Cap



Copper colored injection molded plastic base with post caps to attractively dress up wood posts and your Composite Deck railing posts.



Classic Post Cap

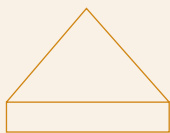

Capri Post Cap

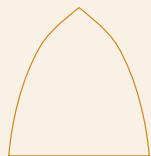

Cardinal Post Cap



4 1/8"
Base Expander
for cladding



3 9/16"
Base

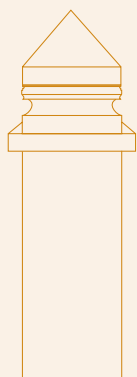

- ← Capri Post Cap
- ← 3 9/16" Base
- ← Optional Expander Base

The Cardinal, Capri and Classic components will attach directly to a 3 9/16" attractive, economical and functional post top.

In addition, they can be used with the 3 9/16" base for added architectural detail or the 4 1/8" "Base Expander" to fit larger posts or those clad with our Composite cladding as part of our Composite decking system.

BUILDING STAIRS

Stairs link your deck to the ground; they also connect different deck levels or span from decks to landing. Though it may at first seem complicated, stair building is actually pretty simple: determine the rise and run, cut your stringers and install your treads, either on cleats or on the stringers themselves.

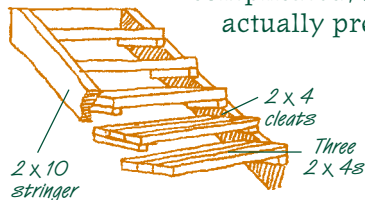

determine the rise and run, cut your stringers and install your treads, either on cleats or on the stringers themselves.

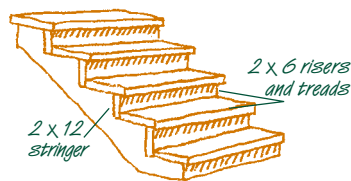

Use steps on cleats when you want an open look.

Use steps on stringers for a more finished look and for wraparound steps.

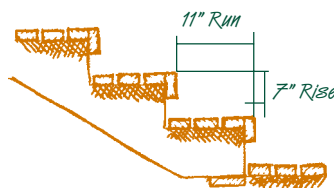

Rise and Run

The rise is the height of each step; the run is its

depth or tread. The ideal rise/run is 7"/11". Why? Because the rise of 7" will accommodate a 2x6 face board, while 11" is enough space to fit three 2x4 or two 2x6 tread boards perfectly.

As your rise decreases, your run must increase, as follows:

Rise	Run
6"	15.5"
5.5"	16"
5"	17"
4.5"	18.5"
4"	19.5"

Stringers: Ready-Made or Cut Your Own?

McFarland Cascade® offers treated Pre-Cut Stair Stringers in 2-, 3-, 4- and 5-Step sizes. Of course, all of our stringers carry a Limited lifetime warranty against decay and termites.



Stair Building Construction Tips

1. You can hang your stringer with a common joist hanger, if you cut a notch in the stringer with a saw.
2. For stairs with more than 5 steps, you may need to install posts for intermediate support.
3. If you cut your own stringers, make sure that the bottom riser height is equal to the rise minus the tread thickness.

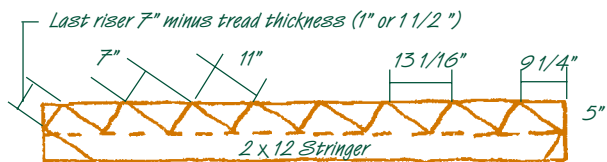

Layout for 7:11 Stringer

4. If the steps lead to the ground, set the stringer on a concrete or treated wood base.
5. Make sure the stringer spacing matches the joist spacing of your deck and landings.

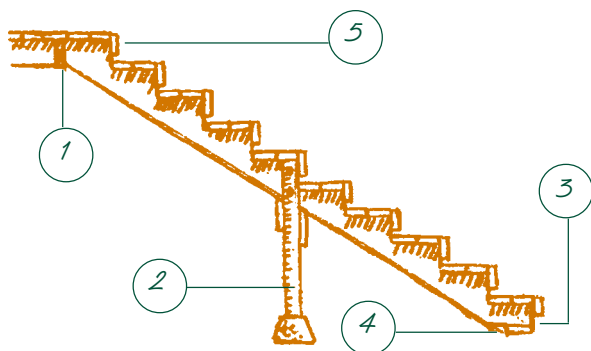

Stairs with Landings

Here is another case of a project that looks more complicated than it really is. Think of a landing as a small free-standing deck. You simply run two regular sets of stairs from this "deck" to the real deck or to the ground.

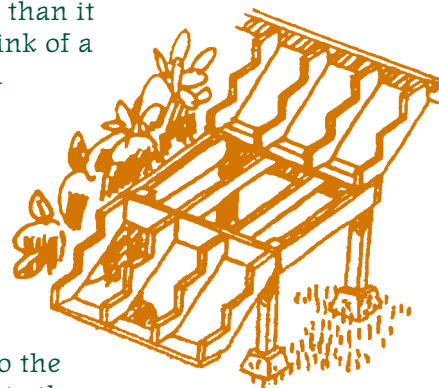

The most critical part of building stairs with a landing is the planning. You must first measure where you want the stairs to begin and end; then you can build the landing at the proper height, and in the proper position in relation to the deck.

Stairs with Landing Details

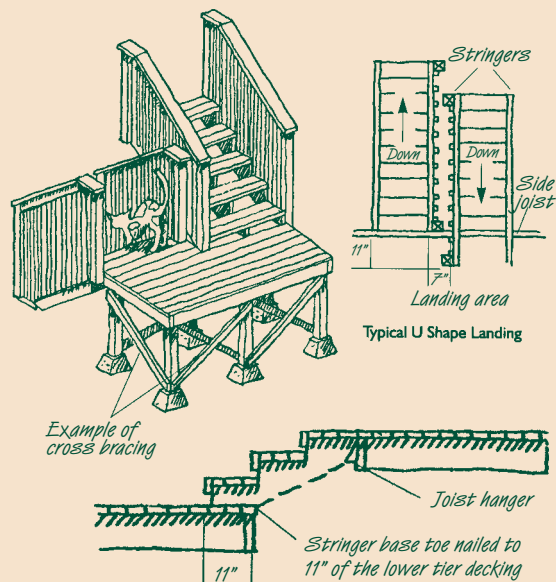

Connecting Stairs Between Tiers

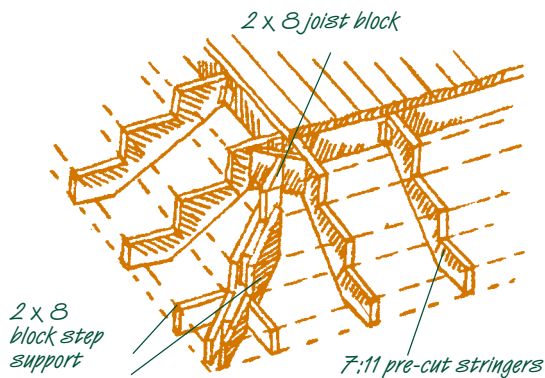

Wraparound Stairs

This kind of stair may seem complex, but it's really just two sets of regular stairs with a connecting area, as shown.

Wraparound Stair Detail

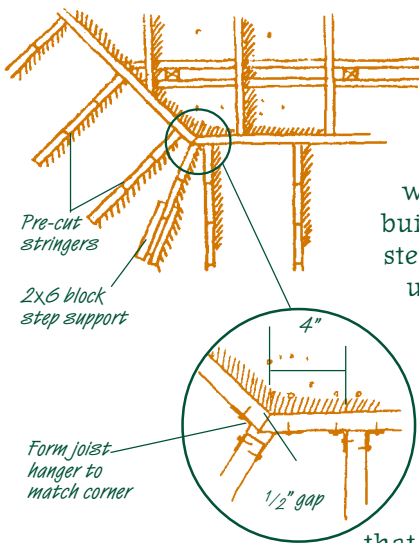

as shown. You will need to build a corner step support using 2x8's, and use a bevel square to cut your tread boards at a 45° angle. Other than that, building

wrap-around stairs

is no more difficult than building regular stairs.

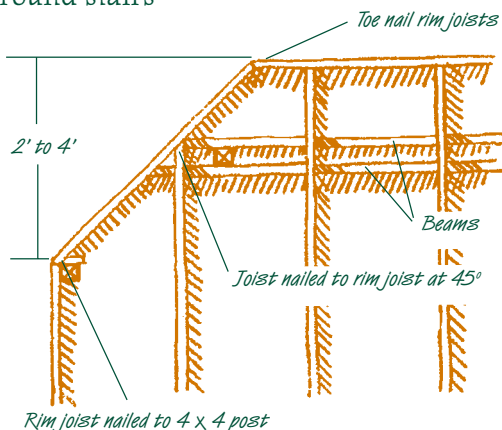

CLIPPING CORNERS

Clipping the corners of your deck is an easy way to make your deck look more interesting. As you can see from the illustration, you will need to make some bevel cuts to the beam, exterior joists and angled support. You can do this with a circular or hand saw.

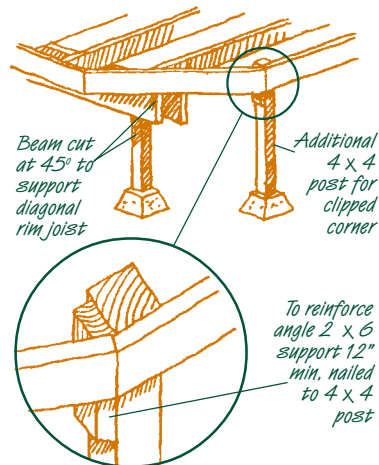

You may clip from 2' - 4' of the deck width or length, as long as in doing so, you do not eliminate a post. Remember, also, that by clipping the corner, you are removing some of the beam; therefore, you will need to install an extra post for support.

CROSS BRACING

When building decks and landings above a certain height, you must cross brace all perimeter posts for added lateral stability. This applies to decks above 6', landings above 3' and freestanding decks above 3'.

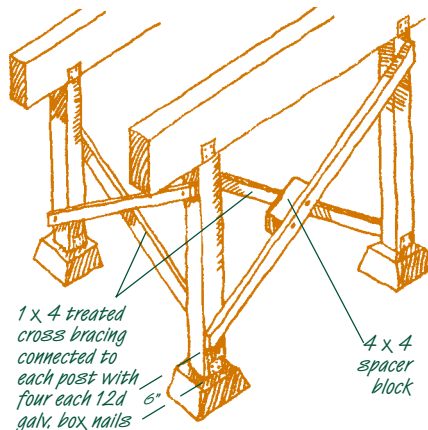

with your local building department for other cross bracing requirements in your area. Refer to the illustration below when constructing your cross bracing.



GREAT FENCES: THE BEST LUMBER:

An attractive, solid fence can be built using a simple combination of common structural and decorative elements

supplied by McFarland Cascade®. Many of these products are covered by the exclusive McFarland Cascade® warranty. Check with your dealer for details.

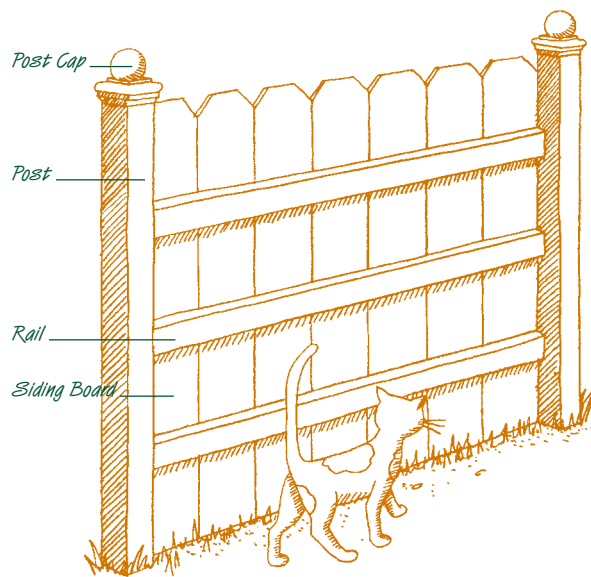
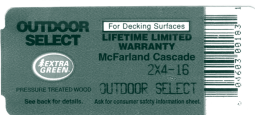

The components of most wooden fences include posts, rails, siding boards and post caps.

Posts

Typically 4"x4"s, the posts provide vertical structural support for the fence and are set directly in the ground. When choosing posts, be sure to look for McFarland Cascade® products with incisions on the surface of the wood, the signature of a product that has been treated to prevent rot from ground contact.

Rails

Horizontal structural members on a fence, the rails, are usually 2"x4"s. Rails keep the fence sturdy and straight and provide a nailing surface for the siding boards. The Treated Framing Lumber chart on page 2 outlines your choices of color and grade.

Siding Boards

Many unique and functional fence styles are possible with the wide range of McFarland Cascade® siding boards. They range from simple 1"x6" material – straight cut or dog ear – to more elaborate, custom cut applications. The use of pressure treated siding board

Common Fencing Lumber Options

Product Choices	Dimensions	Length	Unique Characteristics
Vertical Support	4" x 4" posts	6-, 7- or 8-foot	Used as posts to support; varying grades, treated and untreated
Horizontal Support	2" x 4" rails	Max 8-foot	See framing lumber options
Appearance Fencing	1' x 6" boards	6-foot	Used as fence siding boards; available in square top and dog ear
50% Diagonal Garden Lattice	1/2" and 1" lathe	2' x 8' or 4' x 8' panels	Used as fence siding boards alone or in combination with appearance fencing; garden weave with a larger 2-5/8" opening
70% Diagonal Garden Lattice	1/2" and 1" lathe	2' x 8' or 4' x 8' panels	Used as fence siding boards alone or in combination with appearance fencing; privacy weave with a smaller 1-3/4" opening
Post Caps	4" x 4" or 6" x 6" base		Used to decorate and protect fence posts; see page 9 for styles
Agricultural fencing			See your McFarland Cascade® dealer

(Items vary in grade, treatment and warranty.)

material is highly recommended for its durability. Cedar and redwood are other appropriate choices.

Post Caps

McFarland Cascade® post caps will provide the finishing touch you're looking for.

See post caps in more detail on page 10.



GETTING DOWN TO IT

Building a fence is easy if you follow these six steps. Once you get started, you'll find that there are no real obstacles. Because of the repetitive nature of fence building, your skills will improve as your fence goes up.

1. Choosing Your Fencing Styles and Accessories

The basic fence is formed by a series of 6' or 8' horizontal sections that can be easily covered in a number of attractive ways. Shown here is one simple fence with a basic materials list. Other fencing options are also illustrated. Most have siding boards that are 1" thick, such as 1"x6"s and 1"x4"s.



Materials List

*See Pg. 4 for recommended hardware.

Solid Board

Privacy Fence

6' Tall, 8' Section

- 2 Posts, 4" x 4" - 8'

(One post for each next section)

- 2 rails, 2" x 4" - 8'

- 16 Siding Boards 1" x 6" - 6'

- Galvanized Fence Brackets (optional)*

- Galvanized Nails*

- 2 Bags Ready Mix Concrete (one bag for each next section)

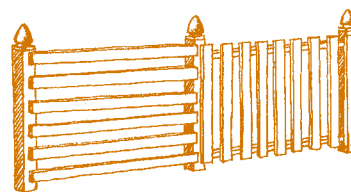

Board on Board — Horizontal and Vertical

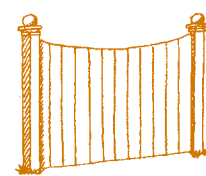

Curved Panel Picket

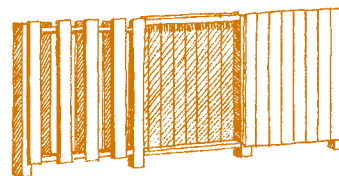

Alternating Boards and Alternating Panels

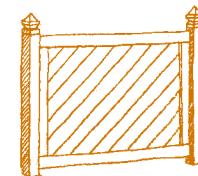

Diagonal Board

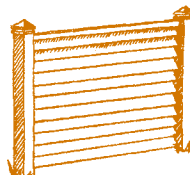

Horizontal Louver
(May also be vertical)



Lattice Top



Closed Post and Board

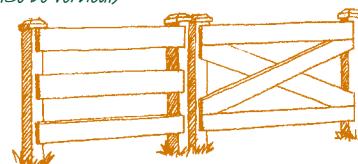

Ranch Rail and Post and Rail

2. Sketching Your Plan

Choose a fence style from the Fencing Styles section in this brochure and then roughly sketch out the planned location of your new fence. Include in the drawing any property boundary lines, structures, large plants or walkways that may be near your fence. Make a note of the fence height that you are considering. You may have a 6-foot fence planned for the backyard and a 3-foot fence in front.

Check your local zoning codes for fencing regulations which may include height restrictions, boundary line set-back requirements and materials restrictions. If your fence will be built near a property line, check its location carefully. If you are unsure of the loca-

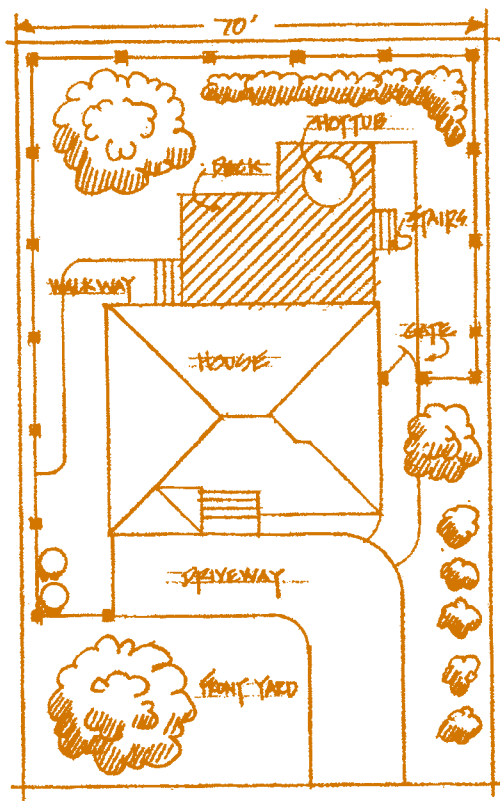

A 6- or 8-foot post spacing is most economical. Shorter sections that are needed to make the fence come out even should be placed at the corners or near the gates and buildings.

3. Accounting for Slope

If your fence will be built over uneven terrain you have two choices. On ground that is rolling and not steep, you can simply follow its natural course. For steeper slopes, you may wish to step the sections. Plan carefully for the differing post and fence board lengths that will be required for a stepped fence.

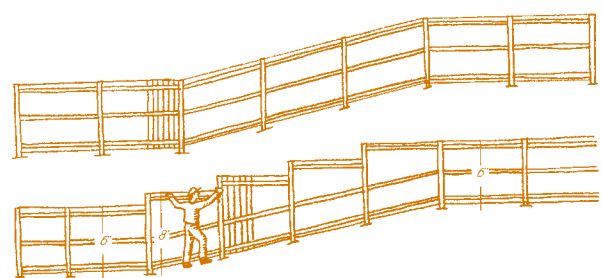

tion of water, gas, electrical or other utilities that may be near your fencing project, call your utility company for location assistance.

Measure the overall length of your planned fence and determine how many fence sections you will build.

4. Digging, Setting and Aligning Posts

Placing the posts for your fence is a five-step process. Take care to make the posts plumb and square. Well placed, straight posts will greatly simplify the fence construction steps that follow. If you are planning a gate, read the Gate Design and Hinges Instructions on page 17 now.

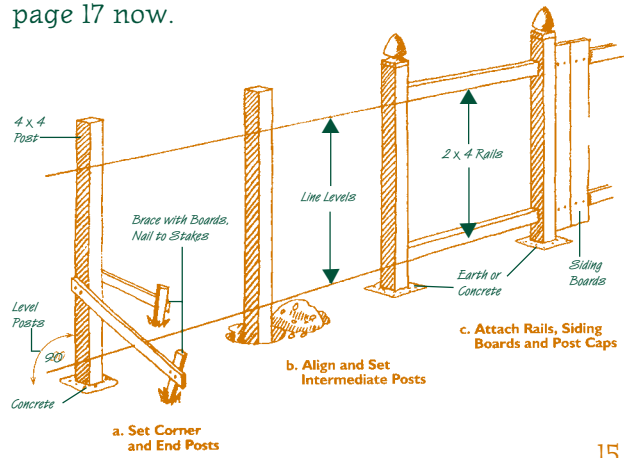

Odd Space at One End

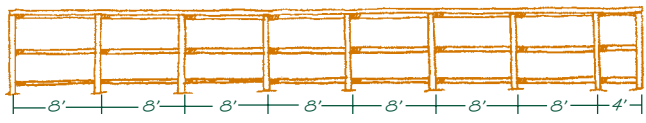

Entire Fence Divided into Equal Intervals

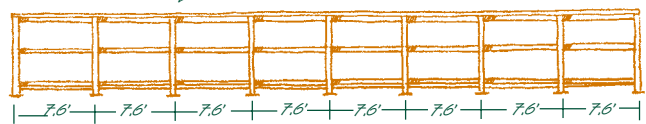

Odd Space at Both Ends and Gate

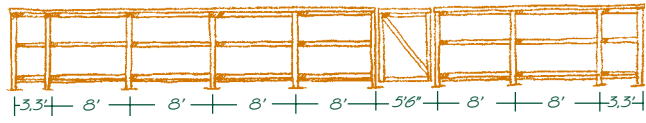

Dig the Holes

Digging the holes for your fence posts is easily accomplished in most soils with a two-handled clam shell digger. Rocky soil may require the use of a digging bar to loosen the soil. Power augers are great labor saving tools if you have many post holes to dig.

The hole should be about 8-inches in diameter for a 4"x4" post. The posts should be set 24 to 36 inches deep for a six-foot tall fence, deeper for a taller fence or deep frost line (if in doubt, consult your McFarland Cascade® dealer). Place a base stone or treated wood block in the bottom of the hole as a post foundation.

Set the Corner or End Posts

Set all of the corner or end posts first. Temporarily hold the posts in place by nailing two braces from each post to stakes driven into the ground several feet away as shown in the illustration on page 15. Adjust the brace as you plumb the sides of the post with a level. To square the posts to each other, use a line-level on two strings stretched between the posts, near the top and near ground level, and readjust the bracing.

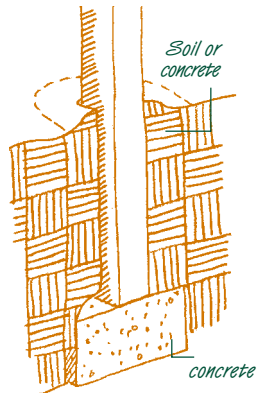

Fill the Holes

Fill the corner or end post holes with concrete. One bag of ready-mix should be enough for each post (more for deeper

post holes). The fill should come 1 to 2 inches above ground level and slope away from the post to divert water. Allow the posts to set for two days before proceeding.

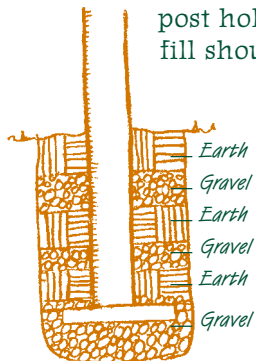

Set the Intermediate Posts

Again, use the line-level

between the corner or end posts as a guide as you set, align and brace the intermediate posts. Intermediate post holes can be filled with earth and gravel or, for a stronger fence in loose or water saturated soil, use concrete.

Trim the Tops

Ensure that the tops of the fence posts are even by trimming the tops off the posts after they have been set - leaving room for post caps as desired. Use end-cut solution on the cut ends. (An alternative is to initially dig each hole to the necessary depth to ensure even tops.)

5. Attaching Railing, Siding Boards and Kickboards

To accommodate slight variations in post alignment, the horizontal rails between post should be individually measured and cut to fit. Use end-cut solution on the cut ends. Typically, the bottom rail is installed about six inches above the ground and the top rail either at the top of the post or six inches below it, if post caps are planned. Use a line-level stretched between end posts to ensure parallel placement, as shown in the illustration on page 15 (Rail installation may vary depending on the siding board application you have chosen.)

Dado

Heavy board fences may be made much stronger with the use of a dado joint to connect the rails to the posts. A chisel and handsaw or power router can be used to form the dado channel. Use a straight edge guide and be sure the work is well clamped. The cut must be square and smooth with sharp edges. Be sure to apply end-cut solution to cut ends.

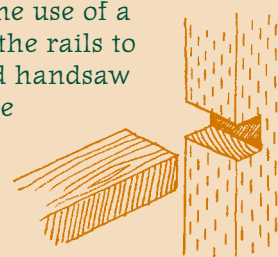

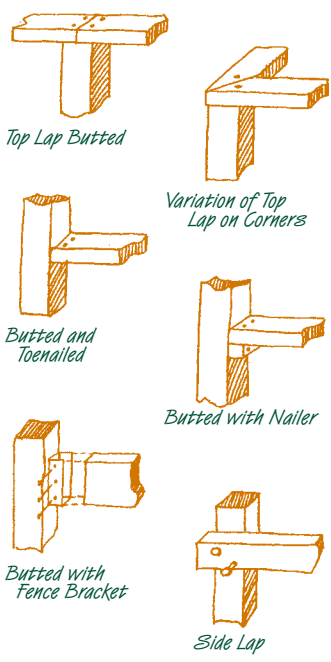

Rails are most easily set with galvanized metal* fence brackets and nails. They may also be butted and toenailed, lapped, blocked or set with a dado. In each case, be sure to use galvanized* nails. Drill pilot holes and stagger the nails in your rails to avoid splitting along grain lines. Attach the fence boards according to the style you have selected. Using a

tight line along the bottom edge will help ensure vertical alignment. Leave a few inches between the bottom of the fencing boards and the ground, or plan for the installation of a kickboard. A spacer will make quick work of evenly spacing the boards on a picket-style fence. Kickboard can be added to the bottom of the fence for added security and to keep pests out and pets in. Use 1" x 4" or 1" x 6" material, as shown, before installing siding boards.

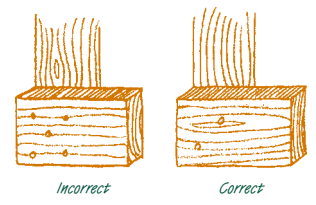

6. Designing Your Gate

Solid construction is the key to a long lasting gate. To install a gate,

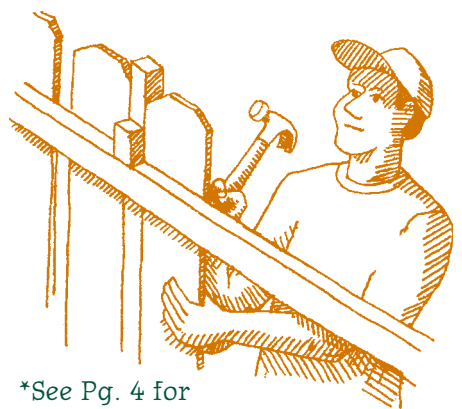

*See Pg. 4 for recommended hardware.

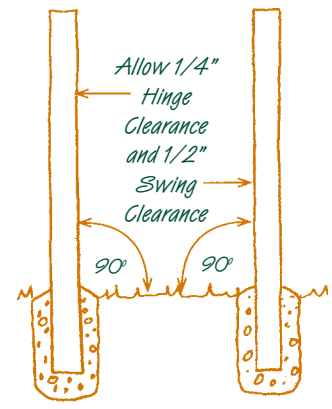

the first step comes when you are setting your face posts. Posts to either side of the gate should be absolutely plumb and set at least 24" in concrete.

The gate itself is framed with 2"x4"s and assembled with wood screws. Make it no wider than 48". Allow

1/2" clearance for the latch and hinges. Use a carpenter's square to keep the framing true. A diagonal brace can be marked and cut to fit inside the gate frame. The top of the brace goes on the latch-side corner and the bottom on the hinge side.

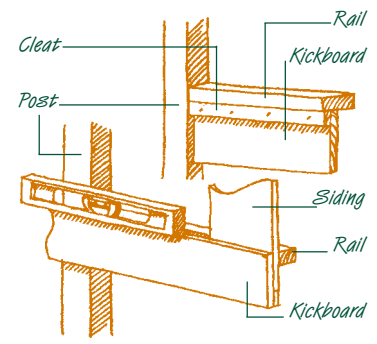

Apply gate hardware and facing boards to the frame with wood screws. When applying the siding boards to the gate, begin on the hinge side and cut the last board flush.

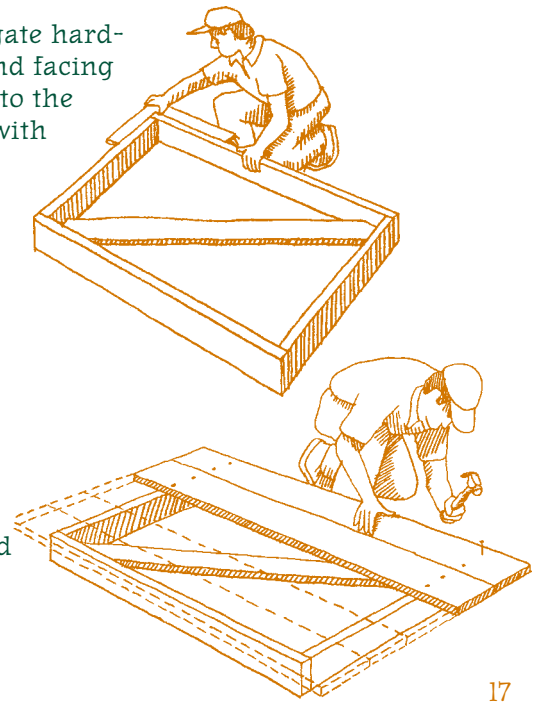



GREAT LANDSCAPING PROJECTS: THE BEST LUMBER

Yards on sloping lots or hillsides can be made more functional with McFarland Cascade® products. McFarland Cascade® products come in a variety of sizes and grades to meet all of your needs. Our 8' treated timbers with the "For Landscape Use Only" tagged product, are excellent for light duty raised garden beds and some stepped walls. For walls supporting heavy loads or retaining significant amounts of earth, it is recommended that local codes be consulted and consideration should be given to getting professional structural guidance. Structurally rated timbers are available through McFarland Cascade® even if they might not be on the shelf at your local retailer. Cherrytone ties make quick work of smaller earth retaining projects. For utility earth retention and patio paving, recycled railroad ties may be your best choice.

McFarland Cascade® treated framing lumber can also be used to construct durable benches, planters, trellises and other garden projects.

IT'S NO CONTEST

McFarland Cascade® Treated Lumber

- Rot Proof
- Termite Proof
- Added Mold Resistance
- Pre-stained
- Competitive Price
- Uniform Appearance

Untreated Wood (Cedar, Redwood)

- Potential Check/Split Resistance
- Typical Lifespan: 5-7 Years in a Wet Climate
- High Cost

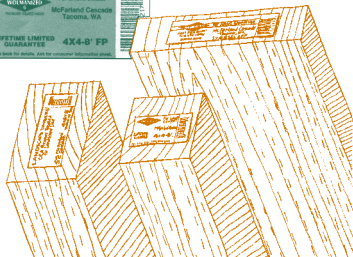

TREATED FRAMING LUMBER OPTIONS

Product Choices	Color	Visual Grade	Unique Characteristics
Construction Select™	Cedartone®	Premium-extra sort	Premium visual grade/ 2" kiln dried prior to treatment to attain greatest dimensional stability
Pro-Framing™	Cedartone®	Regular sort	Designed for professional installers
Cost Cutter®	Cedartone®	Economical sort	McFarland's least expensive option
Outdoor Select®	Cedartone®	Premium-extra sort	Unincised; premium visual grade
Pro-Decking™	Cedartone®	Regular sort	Unincised; designed for professional installers

COMMON LANDSCAPE LUMBER OPTIONS

Product Choices	Dimensions	Length	Unique Characteristics
Landscaping Timbers	4"x6"	8'	Used for rough surface retaining walls and steps; EXTRAGREEN™ pressure treated
	6"x6"	8'	
	6"x8"	8'	
Cherrytone Ties— Treated	3"x4"	8'	EXTRAGREEN™ pressure treated and used for economical earth retaining or fences
Cherrytone Ties— Untreated	3"x4"	8'	Lowest cost for non-structural, light-duty and decorative applications
Railroad Ties	7"x9"	8'	Recycled creosote railroad ties used for utility landscaping and earth retaining

(Items vary in grade, treatment and warranty.)

The Safety of Treated Wood

Treated wood is safe in all applications, from raised-bed vegetable gardens to garden benches. Once the EXTRAGREEN™ is fixed in the wood cells, it is highly leach-resistant. Pressure treated wood is also durable and economical. Because wood is a renewable resource, its use makes good environmental sense.

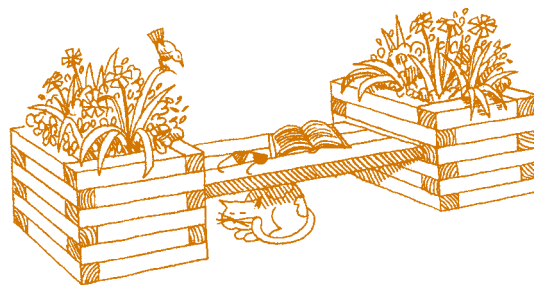

diameter for a 4"x6" timber. Place a base stone or treated wood block in the bottom of the hole as a post foundation.

Fill the timber holes with concrete. One and one-half bags of ready-mix should be enough for each timber (more for deeper post holes).

The fill should come 1 to 2 inches above ground level and slope away from the post to divert water. Allow the timbers to set for two days before proceeding with retaining planks and backfill (for plank material options, refer to the McFarland Cascade® Treated Framing Lumber chart on page 2. One-inch weep holes drilled every four feet along the bottom plank will improve drainage.

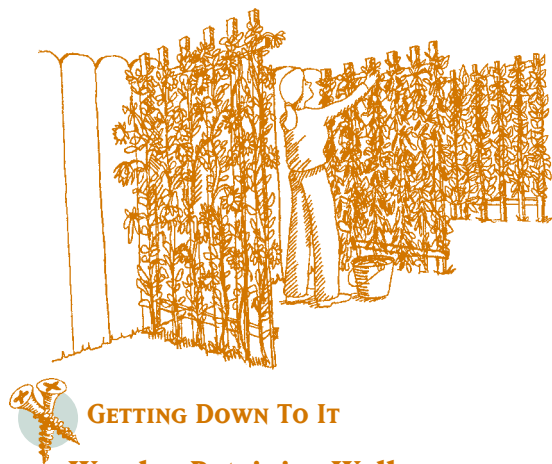

GETTING DOWN TO IT

Wooden Retaining Walls

A simple, low, wooden retaining wall on a gentle slope with stable soil can be easily built. Common wooden retaining walls are constructed in two ways: timbers set into the ground as posts to support planks, or stacked timbers set directly on the ground.

Timber and Plank

For a timber and plank wall, digging the holes for your posts is easily accomplished in most soil with a two-handled clam shell digger. Rocky soil may also require the use of a digging bar to loosen the soil for the clam shell digger. Power augers are great labor saving tools if you have many post holes to dig.

Set the posts 24 to 36 inches deep for a three-foot high wall, deeper for a deep frost line (if in doubt, consult your McFarland Cascade® dealer). The hole should be about 10-inches in

Stacked Timber

A stacked-timber retaining wall is a straightforward project. The bottom timber should be set in a compacted trench below ground and carefully leveled. Place a second timber on top and bore a hole through both timbers with a heavy duty drill and extension bit.

Drive a 3/4 inch pipe or rebar rod through both timbers and well into the ground. Stagger the joints as you add timbers and spike them together on each side of every joint.

For drainage, occasionally leave a 1/4" to 1/2" space at the joint between timbers.

Retaining walls built on very unstable soil may require the addition of a tie back with a stationary stabilization member

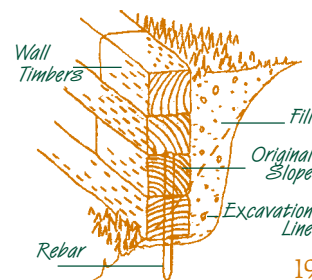

known as a "deadman" to reinforce the wall.

A tie back may also be combined with slightly stepped timber placement. As shown in the adjacent illustration, placement of the tie back and "deadman" will require more extensive excavation into the slope. These supporting timbers are leveled to lie on one course of wall timbers and are spiked into the timber below before setting the next course.

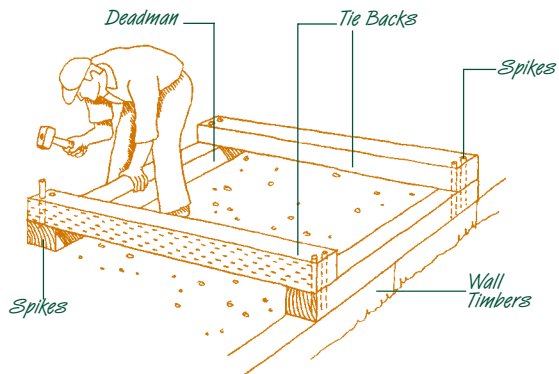
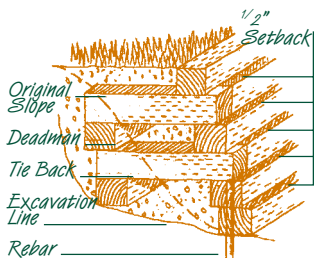

Stepped Timber

A variation on the stacked timber wall is the stepped timber retaining wall. Instead of stacking each timber directly on the one below, pull each course into the slope, creating a series of terraced planting strips up the wall's elevation.

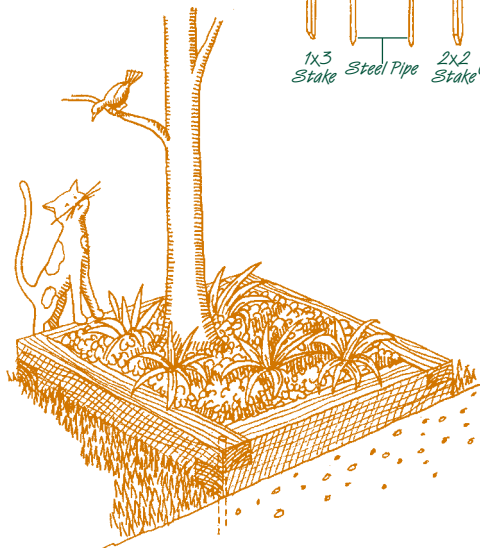
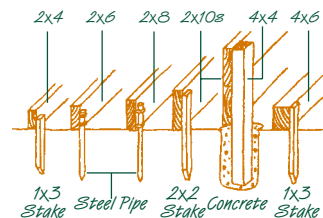
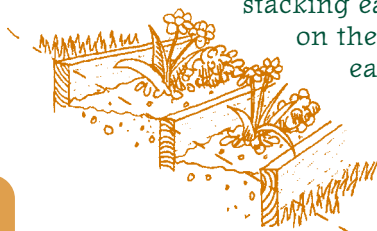

PATIO PAVING

Treated timbers and railroad ties may also be used to create long-lasting borders between paved and planted areas. Staked firmly in the ground, one timber high or at ground level, they can add a distinctive grid pattern to set bricks or paving stones, or as protection in parking areas.

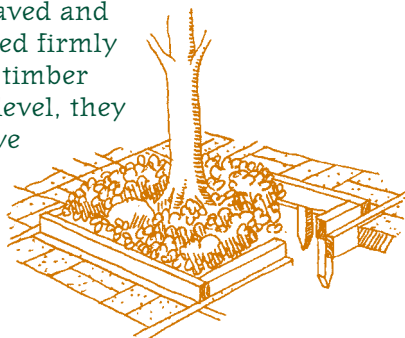

Raised Garden Beds

Raised garden beds can also be constructed using the basic techniques described above. Because a raised bed is typically only one or two planks or timbers high, foundation components may be scaled back.

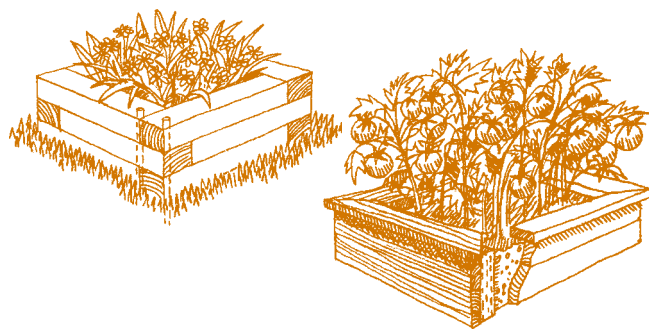

Consumer Safety Information

For additional information call toll-free at 1-800-282-0600 or see our website at www.ccasafetyinfo.com

This wood has been preserved by pressure-treatment with an EPA-registered pesticide, copper azole*, to protect it from termite attack and fungal decay. Wood treated with any preservative should be used only where such protection is important.

In the treating process, copper azole penetrates deeply into the wood where it remains for a long time. However, some chemical may migrate from preserved wood into surrounding soil over time and may also be dislodged from the wood surface upon contact with skin. Exposure to copper azole may present certain hazards. Therefore, the following precautions should be taken both when handling the preserved wood and in determining where to use and dispose of it. Many of these precautions also apply to untreated wood and other building materials.

Use Site Precautions

- All sawdust and construction debris should be cleaned up and disposed of after construction.
- Do not use treated wood under circumstances where the preservative may become a component of food or animal feed.
- Only treated wood that is visibly clean and free of surface residue should be used where contact is likely.
- Do not use treated wood for construction of those portions of beehives which may come in contact with honey.

Handling Precautions

- Dispose of treated wood by ordinary trash collection. TREATED WOOD SHOULD NOT BE BURNED in open fires or in stoves, fireplaces or residential boilers.
- Treated wood from commercial or industrial use (e.g., construction sites) may be disposed of by complying with local landfill rules or burned in commercial or industrial incinerators or boilers when done in accordance with state and federal regulations.
- Avoid frequent or prolonged inhalation of sawdust from wood, treated or untreated.
- When sawing, sanding, and machining wood, wear a dust mask. Whenever possible, these operations should be performed outdoors.
- When power-sawing and machining, wear goggles to protect eyes from flying particles.

- Wear gloves when working with wood. Use proper techniques when lifting.
- After working with wood, and before eating, drinking, toileting, or using tobacco products, wash exposed skin areas thoroughly.
- Because preservatives or sawdust may accumulate on clothes, they should be laundered before reuse.
- Wash work clothes separately from other household clothing.

Tips for Pressure Treated Lumber

Construction Tips

- Use the right tools. You will eliminate extra work, increase your safety, and save time if you have all the tools and materials you need close at hand during each phase of construction.
- Be safe. Use gloves, ear/eye protection, dust masks, and other protective clothing where appropriate.
- Work comfortably. Put away the time clock and work at an easy, methodical pace. Take frequent breaks for rest and food/drink. Fatigue, either physical or mental, is no friend to good construction.
- You may need a permit to build a deck – check with your lumber yard for this and other code information.
- To validate the warranty on your treated wood, all cut ends and bore holes must be treated with a suitable brush-on preservative, such as Wolmanize End Cut Solution.
- ASTM A 153 (Fasteners)
- ASTM A 653 Class G 185 (Connectors)

Maintenance Tips

- To help protect your wood against weather damage, apply an effective brand of water repellent as soon as your project is finished, or, for large projects, as sections are completed.
- The water-based stain color of McFarland Cascade® Treated Deck Lumber will fade with exposure to sunlight. To retain or modify the color, apply a deck stain as required.
- When staining wood, follow the manufacturer's instructions. For best results, the wood should be dry.
- For deck surfaces, a semi-transparent stain is recommended. Paint and opaque stain will show frequently used pathways.
- To revitalize a deck that has become dingy with dirt and mildew, use a deck brightener to clean the wood.

Western Red Cedar

BALUSTERS, RAILS, POSTS AND POST CAPS

McFarland Cascade® cedar specialty products are manufactured from premium quality clear grade western red cedar, providing the ultimate in natural beauty and durability.

McFarland Cascade® cedar specialty products are lightweight, easy to work with, and accept stain or clear wood finish beautifully.

Use McFarland Cascade products on those outdoor projects where only the finest quality and workmanship are acceptable.

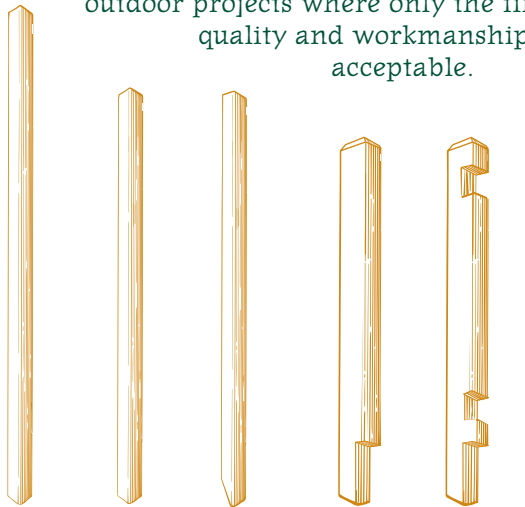

2 x 2 x 4 2 x 2 x 3/8 Square Cedar 2 x 2 x 3/8 Bevel Cedar 4 x 4 x 4/8 Novel Post 4 x 4 x 4/8 Double Notched Post

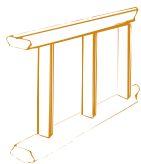

Rail



Ball Cap



Colonial Acorn



Copper High Point



Cascade Peak



Stair Riser



McFarland Flat



Suburban Pyramid

STAIR RISER BRACKET

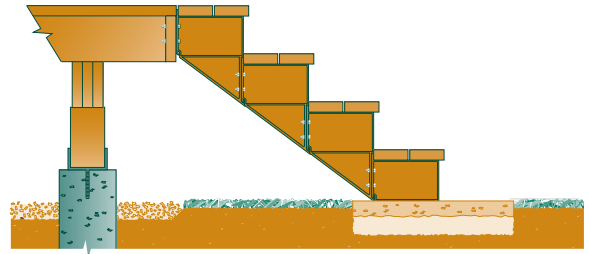

Stair Riser Brackets work in tandem to give strength and support while providing uniformity to your stair design. Easily bolted together, Stair Riser Brackets offer limited measuring to achieve maximum results.

DECK TRACK

Under deck fastening system



Premium Design

- No visible nails or screws on the deck surface.
- Prevents harmful deck rot that forms due to moisture penetration around conventional deck fasteners.
- Easy to install.
- The angle of the Shadoe® Deck Track provides additional fastener tensions, holding the deck boards secure.
- Galvanized Track (90 microns) resist rusting for most deck applications. Powder Coated and Stainless Steel Track for salt water or high humidity applications may be special ordered.
- Made from Heavy Duty 20 gauge steel.
- 30 year warranty.

JOIST CAPS

The Joist Cap is designed to protect and lengthen the life of your deck. It works like an umbrella to keep the joist and underside of the deck plank clean and dry. It is available in both single and double joist widths. (1-1/2" & 3").

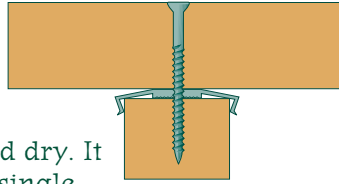

BENCH BRACKET

The easiest way to create lasting perimeter benches with comfortable back support and top rail.

The Bench Bracket is manufactured using Composite Reinforced Plastic Technology to provide you the best product possible.

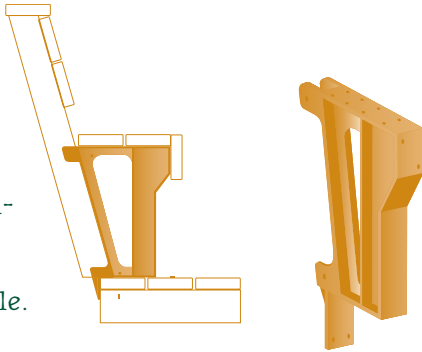

- Easy to install.
- Strong – meets the rigors of everyday use.
- Durable – 10 Year Warranty.
- Assures symmetry in railing & bench spacing.
- Accommodates any length of bench.
- All required hardware and instructions included in package.
- Accommodates 2x4 or 2x6.
- Can be added on existing deck or new construction.
- Wood tone to complement overall deck appearance or ivory tone with ivory composite deck.
- Attractive and discrete appearance from all sides.



Copper colored injection molded plastic base with post caps to attractively dress up wood posts and your EON® railing posts.



Classic Post Cap

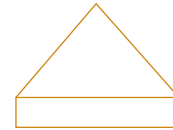

Capri Post Cap

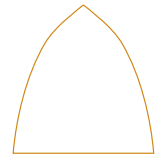

Cardinal Post Cap

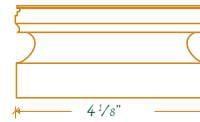

*Base Expander
for cladding*



Base

DECKING

Edeck provides a clean low maintenance and distinctively styled deck to accent any home or landscape project. Assembly is simple and the finished product is strong, with no fasteners showing on the surface. Edeck is safe and easy to work with, yielding results to please even the most discriminating consumer.

- Reversible deck boards
- Edges flare downward
- Hollow core design
- Lightweight and strong – can be installed on 24" centers.



SEE

SEPARATE

COVER

SPREAD

FILE