

# gorilla

playsets



## Laredo

**Model: 1300**

(BOXES: 1300-1, 1300-2,  
Toy Box, 110, Extreme Tube  
Slide & SLIDE BOX)

Copyright © 2013 Gorilla Playsets  
All Rights Reserved

190 Etowah Industrial Court  
Canton, GA 30114

[www.gorillaplaysets.com](http://www.gorillaplaysets.com)



Please inspect and inventory all parts immediately upon accepting delivery. Use the inventory pages in the manual to make sure you have received all necessary parts. The quickest method to get any parts that are missing or damaged is to use our “Quick Response Center” located at:

**[www.gorillaplaysets.com/support](http://www.gorillaplaysets.com/support)**

DO NOT RETURN THIS PRODUCT TO THE RETAILER OR CONTACT THE RETAILER DIRECTLY. THE RETAILER DOES NOT STOCK COMPONENTS.

**PLEASE RETAIN ALL INSTRUCTIONS FOR FUTURE REFERENCE. KEEP THEM IN A SAFE PLACE WHERE YOU CAN REFER TO THEM AS NEEDED. CHECK FOR REVISED INSTRUCTIONS AT:**

**[www.gorillaplaysets.com/manuals](http://www.gorillaplaysets.com/manuals)**

## GORILLA PLAYSETS WARRANTY - 2013

---

Gorilla Playsets® (“Gorilla”) warrants its play sets to be free from defects in workmanship and materials, under normal use and conditions, for 10 years for above ground structural wood components and for one year for all other components (e.g., swings, hardware, plastics, tarps, rope ladder, etc.).

Gorilla warrants all remaining products, including but not limited to its Breckenridge Playhouse™, Free Standing Swing Set, Free Standing Tire Swing, See-Saw, Children’s Picnic Table with Umbrella, Play-Zee-Bo™ and spring riders to be free from defects in workmanship and materials, under normal use and conditions, for a period of 1 year.

**Cosmetic imperfections and natural tendencies of wood such as peeling, splintering, warping, seasonal checking or cracking, knots or knot holes, etc. are normal characteristics of all outdoor wooden play equipment and are not covered by this warranty.**

Wood rot or decay that develops because the product was installed in an area with poor drainage is not covered under this warranty. Lumber that has been damaged by wood boring bees, or conditions that develop as a result of faulty or improper installation of the product, are not covered by this warranty. Fading of stain, discoloration or mold on any wood part or accessory is not covered by this warranty. Cracks in plastic components, surface rust on hardware and chips on powder coated materials are not considered defects in material as long as they do not affect the functionality or structural integrity of the part or component.

It is the owner’s responsibility to maintain the swing set. **This includes but is not limited to re-staining and resealing the lumber as needed and regular inspection to be sure all hardware is tight.** Instructions for proper maintenance can be found on Gorilla’s website. Imperfections or conditions that develop because of a failure to properly maintain the swing set are not covered by this warranty.

Gorilla will repair or, at its discretion, replace any above ground part within the stated warranty period that is defective in workmanship or materials. This decision is subject to verification of the defect, which, at Gorilla’s discretion, may be accomplished by submitting photographs or by delivery of the defective part to Gorilla Playsets • 190 Etowah Industrial Ct. • Canton, GA 30114 • 1-800-882-0272 Monday to Friday 9AM-5PM EST. Any warranty claim must include proof of purchase, including the date of purchase. In addition, within the first 30 days from the date of purchase, Gorilla will replace any parts discovered to be missing from or damaged in the original packaging.

This warranty is valid only if the product is used for the purpose for which it was designed and installed at a residential, single-family dwelling. This warranty is void if the product is used in a commercial, institutional or multi-family setting. **This warranty does not cover normal wear and tear or (a) products that have been damaged by acts of God and/or nature, negligence, misuse or accident; (b) products that have been modified or repaired by unauthorized persons; (c) the cost of labor; or (d) the cost of shipping any replacement product or part.**

GORILLA DISCLAIMS ALL OTHER REPRESENTATIONS AND WARRANTIES OF ANY KIND, EXPRESSED, IMPLIED, STATUTORY OR OTHERWISE, INCLUDING THE IMPLIED WARRANTIES OF MERCHANTABILITY AND FITNESS FOR A PARTICULAR PURPOSE. GORILLA WILL NOT BE LIABLE FOR ANY INCIDENTAL OR CONSEQUENTIAL DAMAGES. This warranty is non-transferable and does not extend to the owners of the product subsequent to the original purchaser. Some states do not allow limitations on implied warranties or exclusion of incidental or consequential damages, so these restrictions may not be applicable to you. This warranty gives you specific legal rights. You may also have other rights which vary from state to state.

# IMPORTANT SAFETY GUIDELINES

This product is recommended for use by children ages 3-11. This product is intended for residential use only and not intended for use in any public setting. A safety surface such as mulch or recycled tire should be used under the play set to prevent injury from falls. Also a 6 foot safety zone should be used around the entire play set.

As with any home project, good judgment and respect for power tools will greatly reduce the risk of injury. Gorilla recommends you follow all tool manufacturers' safety guidelines. Always wear eye protection and safety gloves to prevent injury. In several phases of construction two people may be required for lifting and securing of lumber. While the play set is being constructed, please keep children off the equipment until the project is complete. Bolts and screw heads should be checked regularly for tightness. The ground ladder, rope ladder, slide, swings and other areas where children spend a majority of their playtime should be checked more frequently.

Gorilla shall not be liable for incidental, indirect or consequential damages or injuries that result from building and/or playing on our play sets. Adult supervision is recommended anytime a play set is being used.

## WEIGHT LIMITS FOR GORILLA PLAYSETS

- FORT PLATFORMS: 800 LBS. TOTAL WEIGHT
- SWING BELT: 225 LBS.
- GLIDER SWINGS: 70 LBS. PER CHILD. UP TO 140 LBS. TOTAL WEIGHT.
- TRAPEZE: 125 LBS.
- FULL BUCKET SWING/ HALF BUCKET SWING: 50 LBS.
- HEAVY DUTY TODDLER BUCKET SWING: 85 LBS.
- INFANT SWING: 35 LBS.
- TIRE SWING: 125 LBS. TOTAL WEIGHT
- ROPE LADDER: 75 LBS.
- ROCK WALL: 150 LBS.
- CLIMBING RAMP: 150 LBS.
- MONKEY BARS: 175 LBS.
- ALL SLIDES: 150 LBS.

Gorilla recommends that the weight limits for all components must not be exceeded. Failure to adhere to these and other safety guidelines could result in damage to the play set and injury to the users.



# WARRANTY REGISTRATION

- LAREDO -

Gorilla Playsets manufactures the finest quality products that are designed for outstanding strength and durability. We back our products with an unparalleled warranty. In the unlikely event that you will need to contact us about covered repairs, we must have a valid Warranty Registration on file.

3 EASY WAYS TO REGISTER	
OPTION 1	Fax this completed form to: <b>(678) 880-3329</b> <b>OR</b> Mail this completed form to: <b>Gorilla Playsets</b> 190 Etowah Industrial Court Canton, GA 30114
OPTION 2	Complete the online registration form at: <a href="http://www.gorillaplaysets.com/register">http://www.gorillaplaysets.com/register</a>
OPTION 3	Scan this QR Code with your smart phone to complete the form using your phone 

## Where did you buy this product?:

Date of Purchase \_\_\_\_\_ Place of Purchase \_\_\_\_\_

## Your registration information:

Name: \_\_\_\_\_ Email: \_\_\_\_\_

Address: \_\_\_\_\_  
Street City State Zip

Please select your age?  18-30  31-40  41-50  51+

How old are your children?  2-3  4-5  6-7  8+

How would you rate the quality of this product?

★★★★★ Excellent

★★★★ Above Average

★★★ Average

★★ Below Average

★ Poor

Would you recommend this product to friends & family?  Yes  No

Comments: \_\_\_\_\_

\_\_\_\_\_

\_\_\_\_\_

\_\_\_\_\_

## **IMPORTANT – PLEASE READ**

As fresh lumber acclimates to its new environment, the natural tendencies of the tree can show itself in the form of checks, or “cracks” in the lumber. In almost all cases this is normal and it will not affect the structural integrity of your play set.

Cosmetic defects that do not affect the structural integrity of the product, or natural defects of wood such as warping, checking or any other physical properties of wood that do not present a safety hazard, are not covered by this warranty. Defects that develop because the product is exposed to extreme climate conditions or woodboring insects are not covered by this warranty. Defects that develop as a result of faulty or improper installation of the product are also not covered by this warranty.

**Most cracks are not warrantable**, however if you believe that the integrity of your play set is compromised by this natural occurrence, please follow the warranty claim procedure found at [www.gorillaplaysets.com](http://www.gorillaplaysets.com). Click on the “Customer Care” tab on the left hand side of the page, then click on “Warranty Claim” and follow the directions.

## **KEEPING YOUR PLAYSET LIKE NEW**

### **LUBRICATE:**

- Spray swing hangers with Pam, Mazola or olive oil to stop squeaking.
- Do not use petroleum based products such as WD-40 or motor oil.
- To speed up the slide wipe center of slide ONLY with wax paper every 2 - 3 weeks.

### **TIGHTEN:**

- Check and tighten hex/carriage bolts within first 60 days and then twice annually.
- Check lag screws for tightness before each season and then once during the season for tightness. Tighten lag screws as required.

### **SEAL:**

- Apply an oil based sealer or preservative within 90 days, then every 2 - 3 years. You may need to power wash the unit before sealer application on year two.

### **INSECTS:**

- To repel yellow jackets and wasps, using a cloth, coat all interior 90 degree corners with liquid dish soap underneath the play set deck. This will make wasps sick when they attempt to build a nest. Avoid using insecticides.



**Model: 1300**

(BOXES: 1300-1, 1300-2,  
Toy Box ,110, Extreme Tube  
Slide & SLIDE BOX)

REV: 4.9.2013 (B)

# TABLE OF CONTENTS

Safety Guidelines.....	Pages 3-6
Leveling Fort, General Information and Definitions.....	Pages 6-8
How to Install T-nuts, Board Identification, Predrill Lag Screw Directions and Swing Beam Loading.....	Pages 9-13
Site Plan, Required Tool List and Kit Contents.....	Pages 14-15
Hardware, Lumber and Accessory Checklists.....	Pages 16-33
Framing Lower Porch Level.....	Steps 1-7
Framing Upper Level.....	Steps 8-12
Porch Level and Upper Level Decks.....	Step 13-18
Ladder and Rock Wall Assembly and Installation.....	Steps 19-24
Swing Beam Assembly.....	Steps 25-32
Upper Level Roof, Sunburst and Dormers/Chimney.....	Steps 33-39
Tube Slide Wall Assembly.....	Steps 40-42
Upper Level Center Post and Lower Level Top Panel Board.....	Steps 43-45
Porch Panel Slats.....	Step 46
Swing Beam Wall and Straight Slide Wall Assembly.....	Steps 47-48
Porch Roof Assembly.....	Steps 49-51
Picnic Table Assembly.....	Steps 52-54
Porch and Fort Safety Bars.....	Steps 55-56
Toy Chest, Wave Slide .....	Steps 57-58
Extreme Tube Slide Assembly and Installation.....	Steps 59-60
Tic Tac Toe, Binoculars, Telescope, Flag Kit, Chalkboard.....	Steps 61-65
Safety Handles, Rock Wall Rope, Hanging Swings, Name Plate.....	Steps 66-69
Crown, Telephone, Ground Stakes.....	Steps 70-72

**PLEASE READ OWNER'S MANUAL CAREFULLY  
BEFORE STARTING ASSEMBLY!**

# Safety and Maintenance Tips for Your New Play Set:

**NOTE: Your children's safety is our #1 concern. Observing the following statements and warnings reduces the likelihood of serious or fatal injury. Please review these safety rules regularly with your children.**

- This play set is designed for the use of 4 occupants who have a combined weight not exceeding 800 pounds on the elevated floor, 3 occupants who have a combined weight of 425 pounds on the swing area, for a total Unit capacity of 7 occupants who have a combined weight of 1225. (This weight does not include any picnic table area(s).)
- On-site adult supervision is required.
- Teach children not to walk close to, in front of, behind, or between moving swings or other moving playground equipment.
- Teach children to sit in and never stand on swings
- Teach children not to twist the chains and ropes and not to loop them over the swing beam, since this may reduce the strength of the chain or rope.
- Teach children not to jump from swings or other playground equipment in motion.
- Teach children not to push empty seats. The seat may hit them and cause serious injury.
- Teach children to sit in the center of the swings with their full weight on the seats.
- Teach children not to use the equipment in a manner other than intended.
- Teach children to always go down slides feet first. Never slide headfirst.
- Teach children to look before they slide to make sure no one is at the bottom.
- Teach children to never run up a slide, as this increases their chances of falling.
- The parents should have the children dress appropriately with well-fitting shoes. Loose clothing such as scarves and ponchos should not be worn. Always take off, tie up or tuck in cords and drawstrings on children's clothing. These things can get caught on playground equipment and strangle a child.
- Teach children not to climb when the equipment is wet.
- Teach children to never jump from a fort deck. They should always use the ladder, ramp or slide.
- Teach children to never crawl or walk across the top of monkey bars.
- Teach children to never crawl on top of a fort roof.
- Verify that any suspended climbing ropes, chains, or cables are secured at both ends and that they cannot be looped around an adult hand.
- Teach children not to attach items to the playground equipment that are not specifically designed for use with the equipment, such as, but not limited to, jump ropes, clothesline, pet leashes, cables and chain as they may cause a strangulation hazard.
- Teach children to never wrap their legs around swing chain.
- Teach children to never slide down the swing chain.
- Teach children to remove their bike or other sports helmet before playing on the playground equipment.
- Teach children to NEVER look at the sun or other bright light through any accessory such as but not limited to a telescope, periscope or binoculars.

**WARNING: Children must NOT use this play set until it has been completely assembled and inspected by an adult to insure it has been properly installed and the swing beam legs are anchored.**

## **Safety and Maintenance Tips for Your New Play Set: (continued)**

Playgrounds should be inspected on a regular basis. If any of the following conditions are noted, they should be removed, corrected, or repaired immediately to prevent injuries.

- Hardware that is loose, worn or that has protrusions or projections.
- Exposed equipment footings.
- Scattered debris, litter, rocks, or tree roots.
- Splinters, large cracks, and decayed wood components.
- Deterioration and corrosion on structural components, which connect to the ground.
- Missing or damaged equipment components, such as handholds, guardrails, swing seats.
- Check all nuts and bolts twice monthly during the usage season and tighten as required. (But not so tight that you crack the wood) We recommend you check the swing beam and hardware often due to wood expansion and contraction. It is particularly important that this procedure be followed at the beginning of each season.
- Remove plastic swing seats and take indoors or do not use when the temperature drops below 32°F. Reinstall swings and other swing equipment at the beginning of the usage season.
- Oil all metallic moving parts monthly during the usage period.
- Check all coverings for bolts and sharp edges twice monthly during usage season to be certain they are in place. Replace when necessary. It is especially important to do this at the beginning of each new season.
- Check swing seats, ropes, cables and chains monthly during usage season for evidence of deterioration. Replacement should be made of any swing seat that has developed cracks in the plastic seats. Ropes, cables and chains should be removed and replaced if excessive wear is found. Contact us for warranted replacement parts.
- For rusted areas on metallic members such as monkey bars, hand supports brackets, etc.; sand and repaint, using a non lead-based paint meeting the requirements of Title 16 C.F.R. Part 1303. These requirements are available at: <http://www.cpsc.gov/>
- Inspect wood parts monthly. The grain of the wood sometimes will lift in the dry season causing splinters to appear. Light sanding may be necessary to maintain a safe playing environment. If you are treating your play set with stain regularly, it will help prevent severe checking/splitting and other weather damage.
- Once or twice a year, depending on your climate conditions, you must apply some type of protection (sealant) to the wood of your unit. Prior to the application of sealant, lightly sand any “rough” spots on your set. Please note this is a requirement of your warranty.
- Creating and maintaining the play set on a level location is very important. As your children play, your play set will slowly dig its way into the soil, and it is very important that it settles evenly. Make sure the play set is level and true once each year or at the beginning of each play season.
- Twice a month during the usage season rake the playground protective surfacing materials to prevent compaction and maintain appropriate depths. Replace the protective surfacing materials as required.
- Disposal Instructions: When the play set is no longer desired, it should be disassembled and disposed of in such away that no unreasonable hazards will exist at the time the play set is discarded.

# Play Set Surfacing Recommendations:

Below are some of the recommendations that the U.S. Consumer Product Safety Commission (CPSC) offers from its Handbook for Public Playground Safety. The guide can be downloaded in full at [www.cpsc.gov/cpscpub/pubs/325.pdf](http://www.cpsc.gov/cpscpub/pubs/325.pdf)

**1. Protective Surfacing** - Since almost 60% of all injuries are caused by falls to the ground, protective surfacing under and around all playground equipment is the most critical safety factor on playgrounds.

Certain manufactured synthetic surfaces also are acceptable; however, test data on shock absorbing performance should be requested from the manufacturer.

Asphalt and concrete are unacceptable. They do not have any shock absorbing properties. Similarly, grass and turf should not be used. Their ability to absorb shock during a fall can be reduced considerably through wear and environmental conditions.

Certain loose-fill surfacing materials are acceptable. Surfacing materials are acceptable, such as the types and depths shown in the table.

## Fall Heights and Materials

Type Of Material	6 in. depth	9 in. depth	12 in. depth
Double-Shredded bark mulch	6' Fall Height	10' Fall Height	11' Fall Height
Wood Chips	6' Fall Height	7' Fall Height	12' Fall Height
Fine Sand	5' Fall Height	5' Fall Height	9' Fall Height
Shredded Tires*	10-12' Fall Height	N/A	N/A
Fine Gravel	6' Fall Height	7' Fall Height	10' Fall Height

\*This data is from tests conducted by independent testing laboratories on a 6-inch depth of uncompressed shredded tire samples produced by four manufacturers. The tests reported critical heights, which varied from 10 feet to greater than 12 feet. It is recommended that persons seeking to install shredded tires as a protective surface request test data from the supplier showing the critical height of the material when it was tested in accordance with ASTM F1292.

*It should be recognized that all injuries due to falls cannot be prevented no matter what surfacing material is used.*

**2. Fall Zones** - A fall zone, covered with a protective surfacing material, is essential under and around equipment where a child might fall. This area should be free of other equipment and obstacles onto which a child might fall. Stationary climbing equipment and slides should have a fall zone extending a Minimum of 6' in all directions from the perimeter of the equipment.

Swings should have a fall zone extending a minimum of 6' from the outer edge of the support structure on each side. The fall zone in front and back of the swing should extend out a minimum distance of twice the height of the swing as measured from the ground to the top of the swing support structure.

## LEVELING YOUR FORT DURING ASSEMBLY

- Complete the steps which will be the basic frame of the fort. {i.e. four corner posts with base (sand box boards) and deck supports}
- Position in the most level area chosen for the play set, keeping in mind the location and size of the swing beam, ladder, slides, etc. that extend off the fort.
- Once the frame is in the final position, check for vertical and horizontal levelness to determine which side(s) will need to be dug into the ground to level the play set.
- With a shovel, score the ground around the outside edges of the sandbox boards on the 'high' side of the fort. This is the area that will be dug in. Make sure to score deep enough; the scored lines will be your digging template.
- Push the frame off and away from the scored area, far enough to dig and remove dirt to reach the appropriate depth.
- Dig a channel along the scored line(s) for the base of the fort (corner post and sandbox boards) to rest into. Dig the channel(s) to the same level depth. The bottom of the channel(s) should be level to each other so your frame doesn't teeter or rock because the channel(s) are uneven.
- Once you have removed enough grass and dirt, slide/push the frame into the channel(s). Place a level on the vertical and horizontal boards of the frame to determine if enough soil, or too much, was removed.
- Repeat this process until the basic frame is plumb and level and in its final position before completing the rest of the assembly.
- Measure to make sure fort is square.

**Important: if you require a channel depth of more than 6", then we recommend you have your play set area professionally graded before completing assembly.**

*Example Play area:*

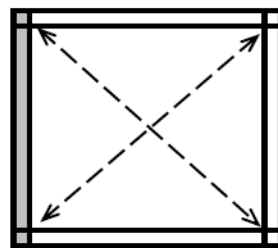
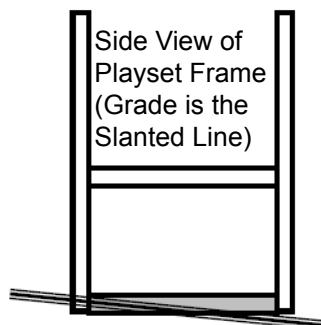

The diagonal measurements should be the same from corner post to corner post. If not, adjust corner posts so that the distance is equal.

■ = Area to be scored and channeled for levelness



# General Info to Review Before Installation

- Depending on your experience, assembly of the playset can take as little as 6 hours up to 24 hours, depending on size, after inventory of parts; therefore, we recommend you set aside a full two days for assembly.
- Identify all of the parts for your play set. Empty each box and lay out boards so you can see each part. Your instruction book will have detailed drawings that will make it easy for you to recognize individual parts. Keep all hardware and metal parts separate from wooden pieces.
- After everything is laid out, check carefully to ensure all parts are present. Make sure there are no broken boards.
- Find an area to sort your hardware. It is best to open the hardware on a solid surface so that you do not lose any pieces in the grass. This will save time and familiarize you with all the different pieces in the hardware bag.
- Important note: Wood has some natural defects such as knots, surface cracks, etc... We reject parts that are structurally defective. We use a high quality lumber in our structures; however, you should inspect each part for splinters or rough spots and sand them smooth to prevent injury.
- After familiarizing yourself with all of the components, read all instructions thoroughly. Reading instructions after you have studied the parts will help you understand the installation process, and help to eliminate unnecessary mistakes.
- Pay close attention to the diameter and length of each bolt and screw.
- Never tighten hardware completely at first. It helps to have some adjustment for bolt alignment while you are attaching parts together. After everything is square, tighten each joint.
- After the main unit is assembled it is critical that the floor is level and square. If the main frame is not level, the walls and floor will be out of square.
- After you complete installation, make sure every bolt, screw, and nut is tight, and every board is secure. Wood will expand and contract with the seasons.
- Place the set on level ground, not less than 6 feet from any structure or obstruction such as a fence, garage, house, overhanging branches, laundry lines, or electrical wires.

**This page is a list of definitions and explanations used throughout our instructions to aid you in the assembly of your play set.**

**Offset Holes-** Throughout the installation procedures we will refer to parts with offset holes. This refers to the orientation of the holes on the board. An offset hole is one that is closer to one side than it is the other or in other words, it is not centered on the board. In the procedures you will be instructed to attach the boards with the holes offset up or with the holes offset down. This refers to which side of the board the hole/holes should be closer to. Offset holes up= hole/holes will be closer to the top of the board. Offset holes down= hole/holes will be closer to the bottom of the board. Note: some parts do not have offset holes, but instead the holes are on center. Therefore there will not be any reference on how to offset these parts.

**EXAMPLE OF OFFSET HOLES UP**



**EXAMPLE OF OFFSET HOLES DOWN**



**Counter-sunk holes** - Many of the parts that will be used have counter-sunk holes. A counter-sunk hole is one that surrounds one side of a through hole, but does not extend through the wood it's self. When using a counter-sunk hole the bolt will be inserted through the through hole and either the head of the bolt and washer or nut and washer will occupy the counter sunk hole.

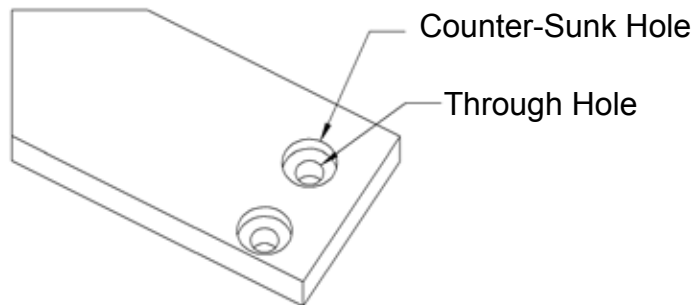

**Lag Screws-** Lag screws are used in the construction of our play sets to enhance the structural integrity of the unit. There will not be predrilled holes in the post for lag screw installation. Lag screws are self-tapping, though if you are using a manual socket wrench it may be advantageous to pre-drill a hole first. Instructions for this are provided on a separate page in the front of the manual. Be sure to tighten the lags completely when driving them in by hand. Power tools such as a heavy duty impact driver or large power drill should have enough torque to drive in the lag screws, but make sure not to over tighten as this can cause the threads to “strip out” in the post.

# Common Installation Practice Installing T-nuts

When installing T-nuts into the wood, use a smooth faced hammer to set the face of the T-nut flush into the wood

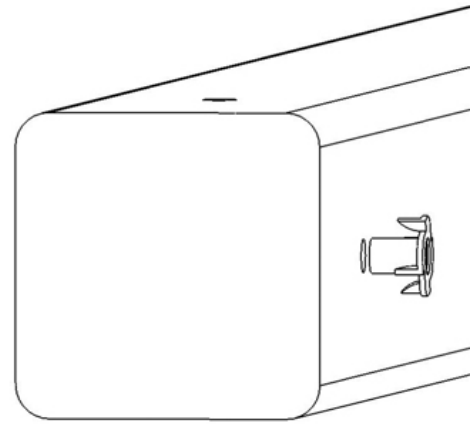
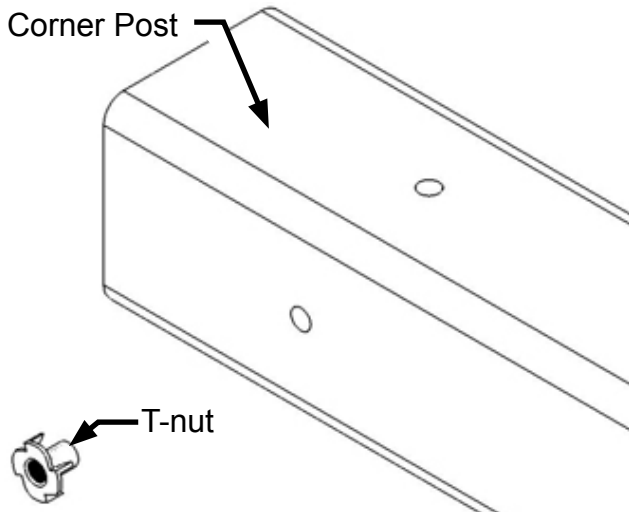

Insert the barrel of the T-nut into the predrilled hole. Using a smooth faced hammer, drive the T-nut until the face of the T-nut is flush to the wood.

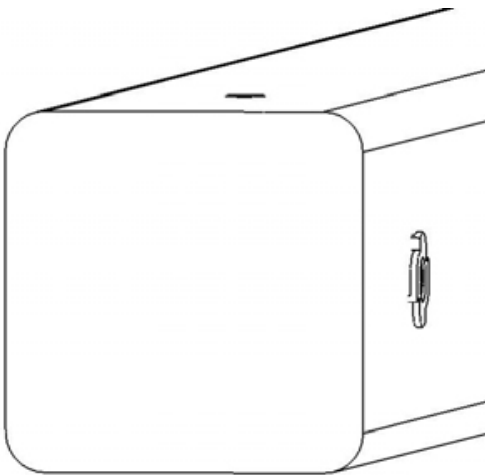

This picture shows the T-nut inserted and installed flush to the wood.

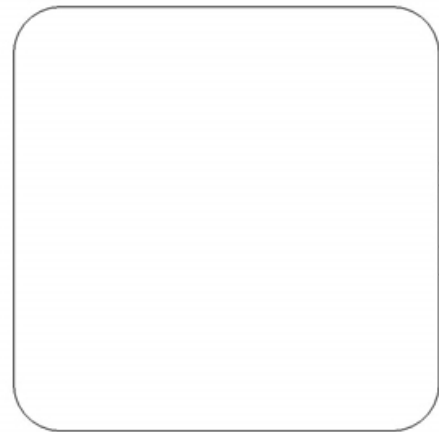

This picture shows an end view of the T-nut installed flush to the wood.

**WARNING: DO NOT EMBED THE TOP OF THE T-NUT INTO THE FACE OF THE WOOD**

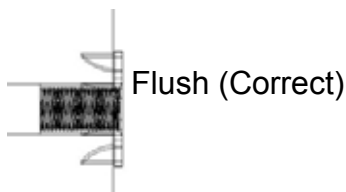

Cross Section end view, you are looking at an X-ray view of the post and T-nut. The barrel of the T-nut is in the corner post the line is the face of the wood.

# HOW A T-NUT WORKS

THE FIRST STEP IN OUR ASSEMBLY INSTRUCTIONS IS TO INSERT T-NUTS INTO THE CORNER POSTS. A T-NUT IS A FASTENER WHICH IS THREADED ON THE INSIDE AND IT FUNCTIONS JUST LIKE A STANDARD HEX NUT. YOU INSERT THE T-NUTS INTO THE PREDRILLED HOLES IN THE CORNER POSTS.

THE T-NUT HAS A BARREL SHAPED END WHICH GOES INTO THE HOLE IN THE CORNER POST. THE T-NUT ALSO HAS AN FLANGE SHAPED END WITH TEETH. THE TEETH PENETRATE INTO THE CORNER POST WOOD TO PREVENT THE T-NUT FROM SPINNING WHEN YOU TIGHTEN THE HEX HEAD BOLT.

SHOWN BELOW YOU WILL SEE THE T-NUT IS HAMMERED INTO THE CORNER POST ON THE BACK SIDE. THE BOARD IS BEING ATTACHED ON THE FRONT SIDE OF THE CORNER POST.

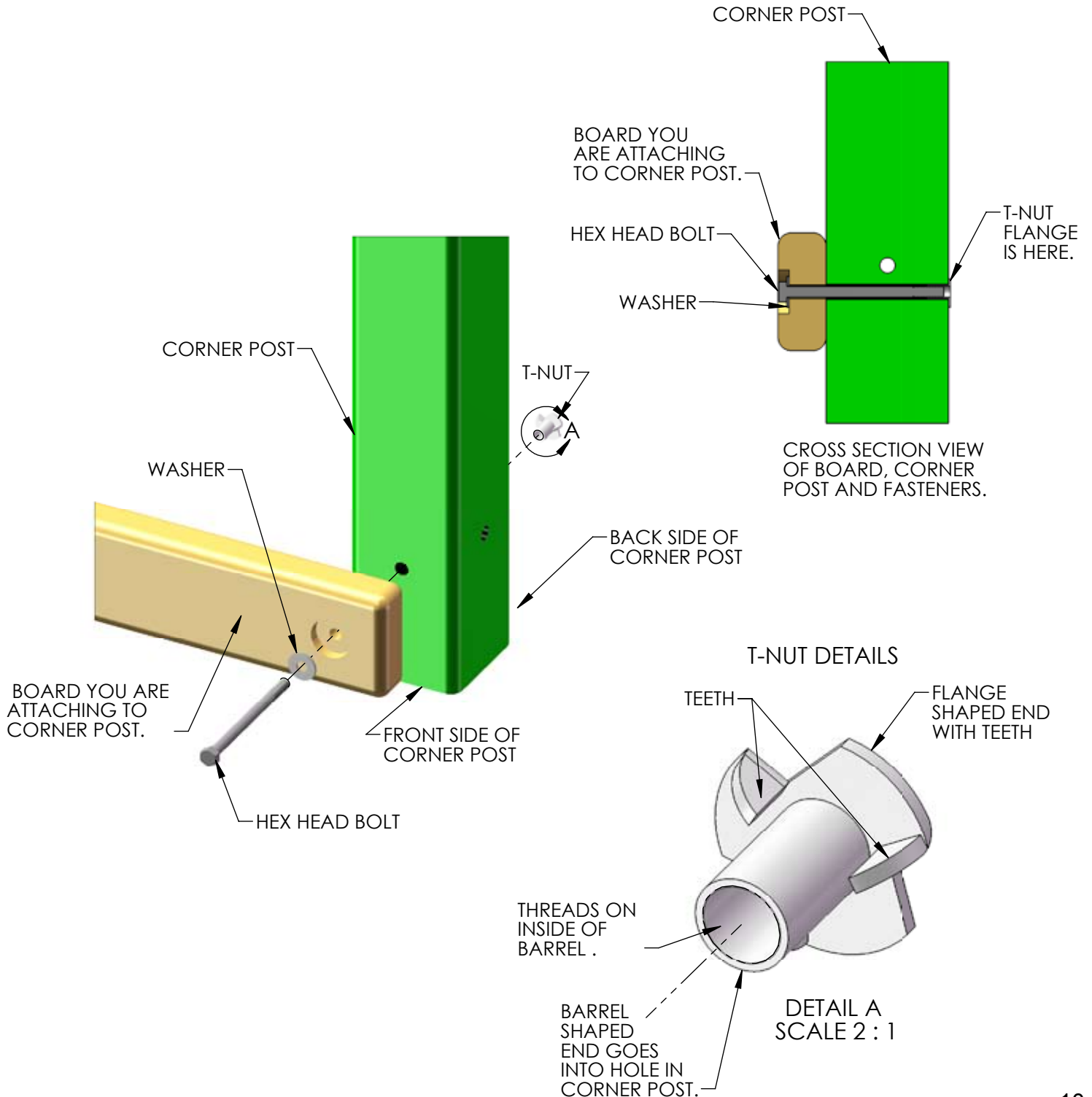

# BOARD IDENTIFICATION

1. On the end of each board there should be a small white tag that is stapled into place.
2. This white identification tag displays the thickness, width, length and an abbreviated description of the part.

Example: a tag reads "2-4-3600-BPB"

- The 2 is the thickness of the board. "Nominal Lumber" at a home center will measure 1-1/2" for the thickness. We "remill" that lumber to 1-3/8" thick.
- The 4 is the width of the board. "Nominal Lumber" at a home center will measure 3-1/2" for the width. We "remill" that lumber to 3-3/8" wide.  
Note: sometimes the width will be smaller than 3-3/8" because:  
A) We need the width of the part to fit into a certain area of the play set.  
B) We need the designation to be simple.
- The 3600 is the length of the board. It means the board is 36 inches long. If the code were 3625 then the board is 36-1/4" in length.
- The "BPB" abbreviation stands for "Bottom Panel Board". The wood part bill of materials in the instructions has a description which will match the abbreviation closely.
- In the event that there is no tag on a wood part measure the part then:  
A) Use the measurements and compare them to the wood list at the front of the instructions to identify it.  
B) Look at the holes on the wood part and compare them to the pictures in the wood list.  
C) Look to see if the holes are centered or if they are offset up or offset down.  
This should help you identify any parts that have missing tags. In the event that you cannot identify a board please email us for assistance.

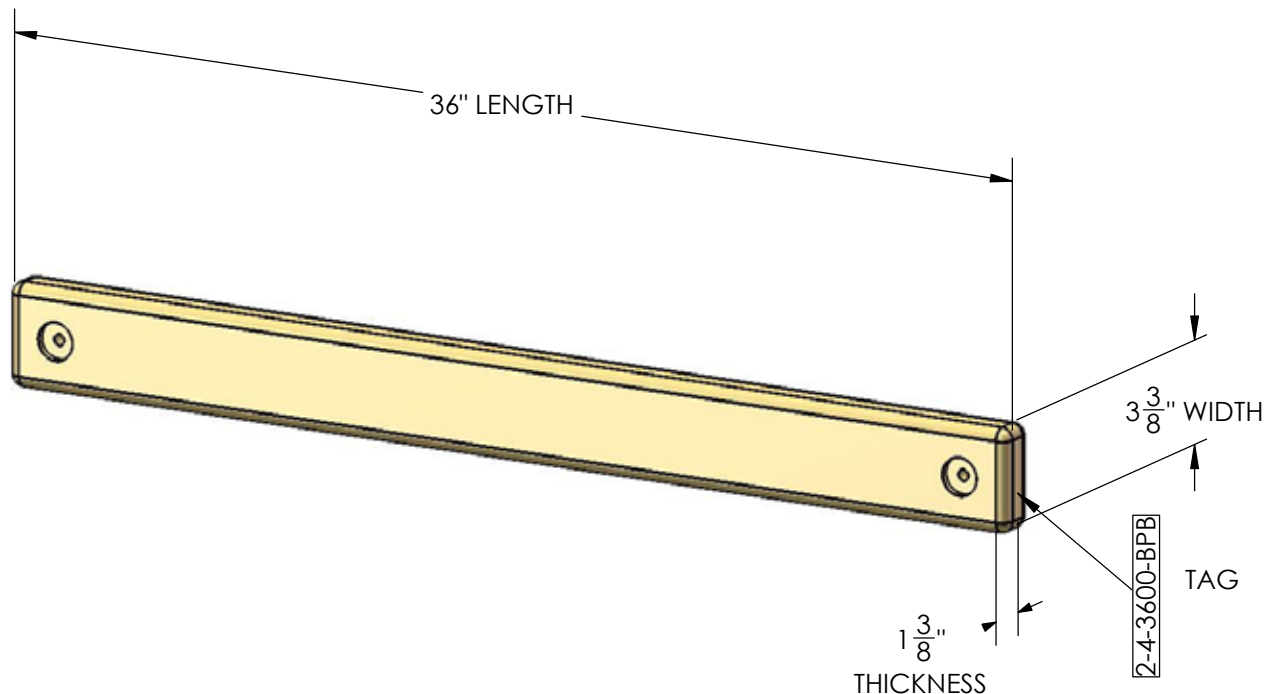

# PRE-DRILL LAG SCREW DIRECTIONS

Pre-drilling holes for lag screws will make it easier to drive the screws in by hand. "Jobber" length drill bits are available in sizes that are longer than standard drill bits and those are ideal for the job. When using the drill bit you will have to "spot" drill the post and then remove the board you are attaching to finish drilling the hole.

Pay attention to the *DIAMETER* of the lag screw you are installing. Your playset may come with two different diameter lag screws. Each diameter will require a different size drill bit. When installing lag screws **DO NOT OVERTIGHTEN.**

LAG SCREW DIAMETER	DRILL BIT SIZE
5/16" DIAMETER	9/64"
3/8" DIAMETER	11/64"

### Example: 3/8" diameter x 3-1/2" lag screw

This would be like the 2 x 4 board installation shown below. Place the board into position. Spot Drill through the holes in the 2 x 4 board into the corner posts with an 11/64" drill bit. Remove the 2 x 4 board. Continue to drill the holes to a total depth of 2-5/16" as shown at the right. Install the 2 x 4 board.

### Example 5/16" diameter x 3-1/2" lag screw

This would be like the 2 x 4 board installation shown below. Place the board into position. Spot Drill through the holes in the 2 x 4 board into the corner posts with an 9/64" drill bit. Remove the 2 x 4 board. Continue to drill the holes to a total depth of 2-5/16" as shown at the right. Install the 2 x 4 board.

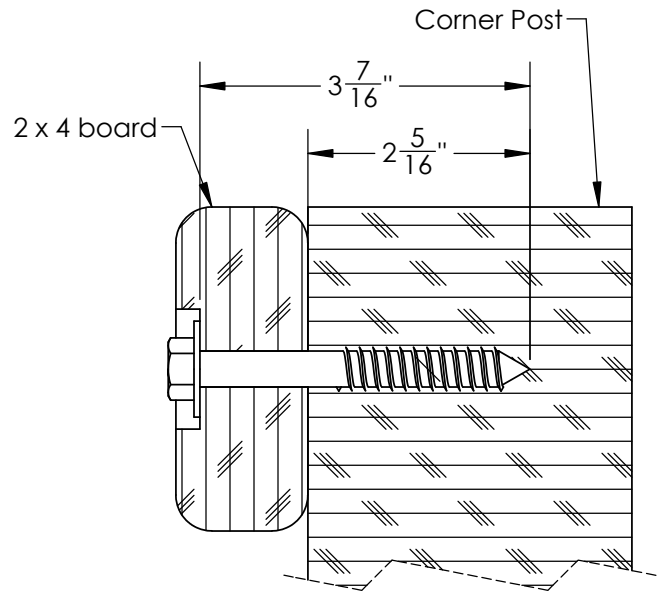

### Example 3/8" diameter x 5" lag screw

This would be like the 4 x 4 board installation shown below. Place the board into position. Spot drill through the holes in the 4 x 4 board into the corner posts with an 11/64" drill bit. Remove the 4 x 4 board. Continue to drill the holes to a total depth of 2-13/16" as shown at the right. Install the 4 x 4 board.

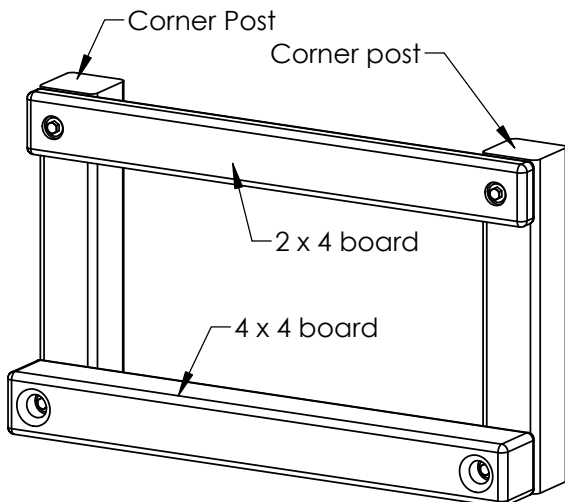
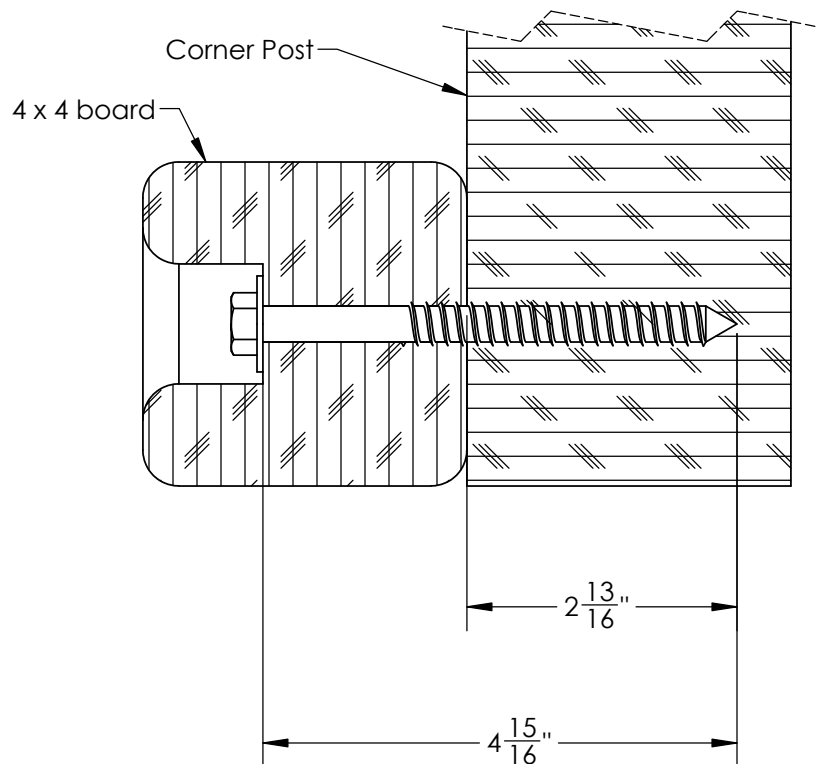

# SWING BEAM LOADING

## Weight Limits for Accessories:

The weight limit for a Swing Belt is 225 lbs. (Although 150lbs is the maximum recommended swinging weight capacity for the swing position.)

The weight limit for a Trapeze Bar is 125 lbs.

## Maximum Allowable swinging weight for a three position swing:

- 1) The maximum allowable swinging weight at each Swing Belt position is 150 lbs.
- 2) The maximum allowable swinging weight at the Trapeze position is 125 lbs.
- 3) The MAXIMUM SWING BEAM LOAD IS 425 lbs.

**MAXIMUM SWING BEAM LOAD IS 425 LBS.**

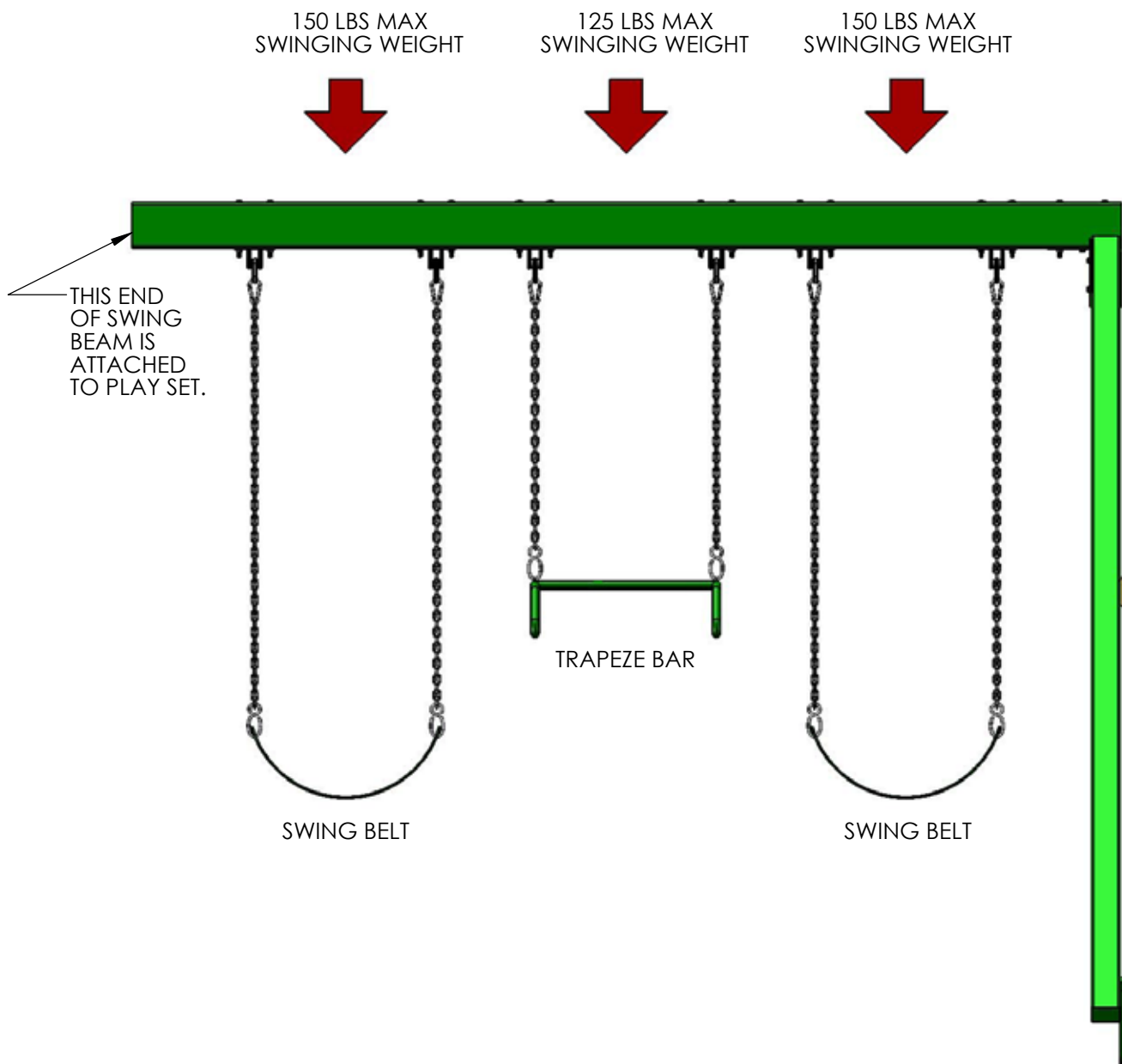

**Please familiarize yourself with the manual, parts/components and general construction process of your new playset before getting started.**

**SITE PLAN:**

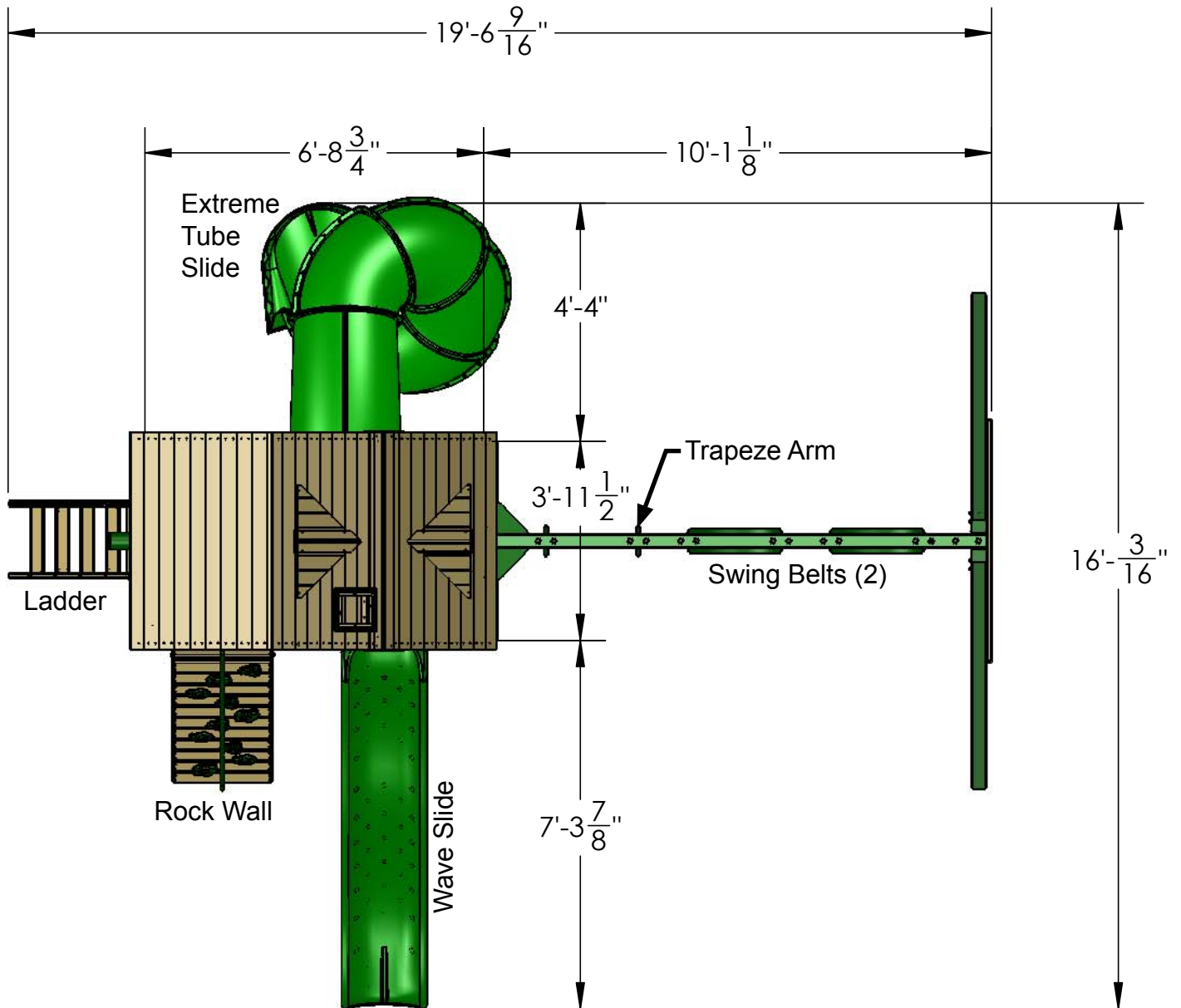

Playset height: 12 feet - 2 inches

Swing Beam height: 7 feet - 10-1/4 inches

Deck heights - Lower Deck: 4 feet , Upper Deck 5 feet

Approximate assembly time: 12-14 hours

**(6) foot unobstructed safety perimeter around playset recommended**



## **REQUIRED TOOL LIST:**

- Standard or Cordless Drill w/ Phillips Bit (#2 square bit provided)
- Drill Bits 1/8", 3/8", 9/64", 11/64"
- 1/2" Wrench and Socket
- 1/2" Deep Well Socket
- 9/16" Deep Well Socket
- 9/16" Wrench and Socket
- Level
- Tape Measure
- Extension Cord (if using standard drill)
- Hammer
- Pencil
- Locking Pliers (Vise Grips)
- Shovel

## **KIT CONTENTS**

### **Swings, Slides, Accessories:**

- (Qty ) Description
- (2) Swingbelt w/ Chains
- (1) Trapeze w/Chains
- (1) Wave Slide
- (1) Extreme Tube Slide
- (1) Toy Chest
- (1) Chalkboard
- (1) Jumbo Binoculars
- (1) Telephone
- (10) Rock Wall Grips (assorted colors)
- (3) Window
- (4) Crown
- (1) Telescope
- (4) Safety Handle
- (2) Flag Kit
- (1) Tic Tac Toe
- (1) Ground Stakes (1 pair)

### **Fort Hardware:**

*see following pages*

### **Swing Beam Hardware:**

*see following pages*

### **Wood Components:**

*see following pages*



#14 X 1-1/4"  
PAN HEAD SCREW  
QTY: 4

#8 X 1-1/4"  
WOOD SCREW  
QTY: 12



#8 X 1-1/2"  
WOOD SCREW  
QTY: 118



#8 X 1-3/4"  
WOOD SCREW  
QTY: 12



#8 X 2"  
WOOD SCREW  
QTY: 313



#8 X 2-1/2"  
WOOD SCREW  
QTY: 42



#8 X 3"  
WOOD SCREW  
QTY: 37



11-0045 HARDWARE  
PAGE 1 OF 2  
REV B: 11/28/2012 JH

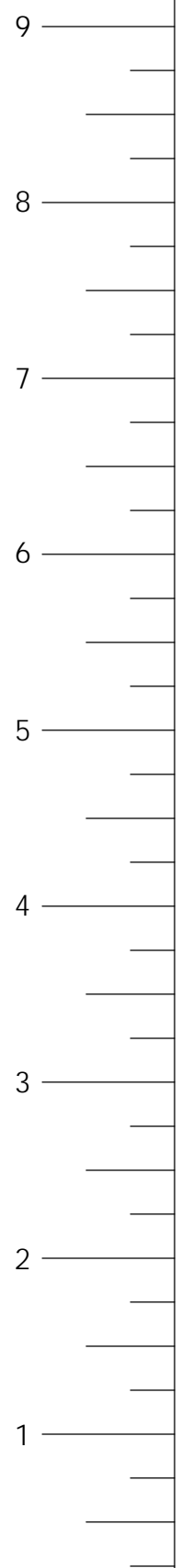

5/16 X 1-1/2"  
HEX BOLT  
QTY: 8



5/16 X 2-1/2"  
HEX BOLT  
QTY: 1

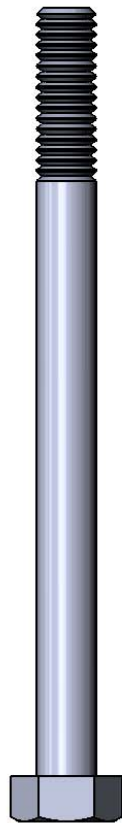

5/16 X 4-1/2"  
HEX BOLT  
QTY: 58

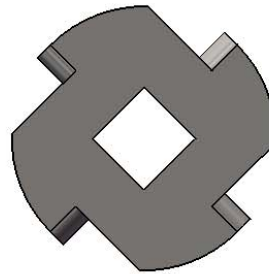

TORQUE WASHER  
QTY: 17

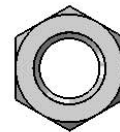

3/8" LOCK NUT  
QTY: 19

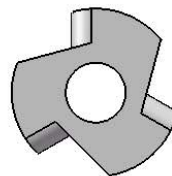

5/16" TEE NUT  
QTY: 67

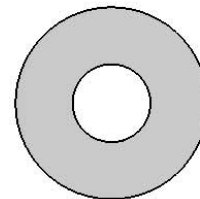

3/8" WASHER  
QTY: 31

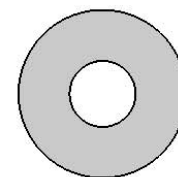

5/16" WASHER  
QTY: 104

USE THE RULER TO THE RIGHT TO MEASURE YOUR BOLTS AND SCREWS. PICTURE VIEWS SHOWN ABOVE ARE 1:1 SCALE AND CAN BE USED TO MATCH BOLT AND SCREW SIZES.

11-0045 HARDWARE  
PAGE 2 OF 2  
REV B: 11/28/2012 JH

3/8 X 3-1/2"  
HEX LAG SCREW  
QTY: 12

5/16" X 3-1/2"  
HEX LAG SCREW  
QTY: 37

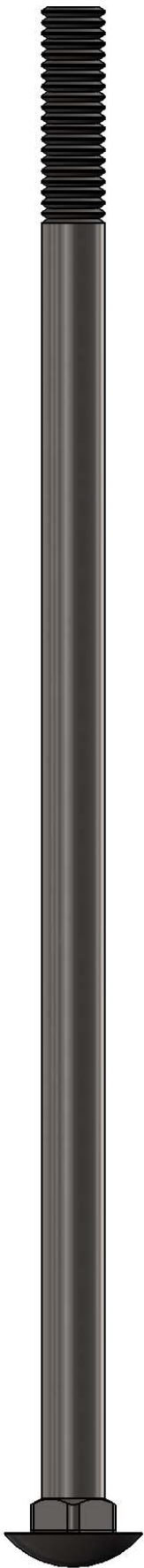

3/8 x 9"  
CARRIAGE BOLT  
QTY: 1

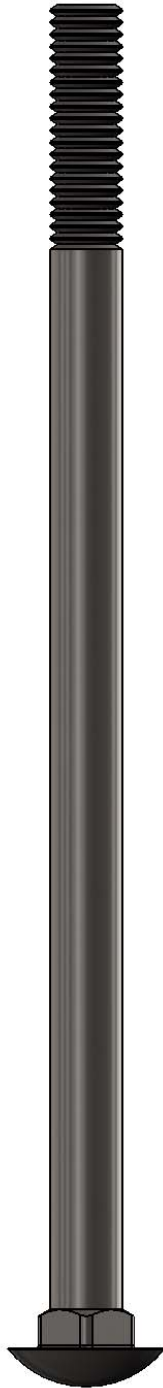

3/8 x 7"  
CARRIAGE BOLT  
QTY: 14

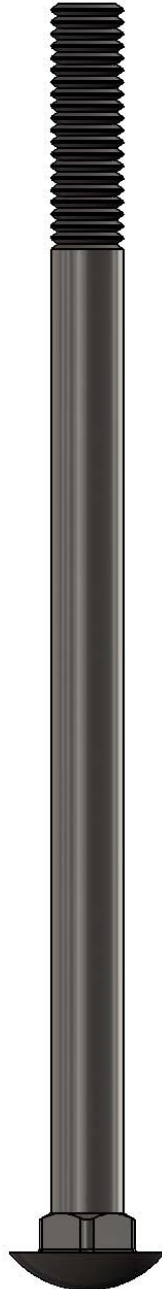

3/8 x 6-1/2"  
CARRIAGE BOLT  
QTY: 2

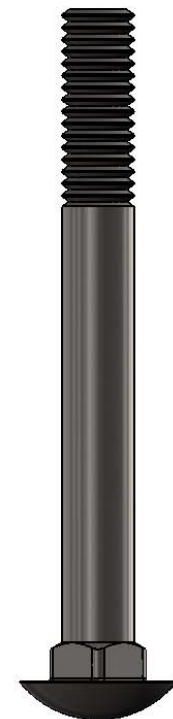

3/8 X 3-1/2"  
CARRIAGE BOLT  
QTY: 2

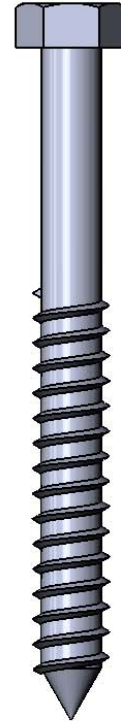
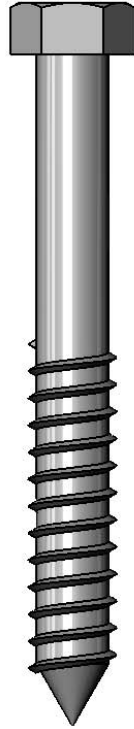

#2 SQUARE  
DRIVE BIT  
QTY: 1



PLASTIC  
BOLT CAP  
QTY: 19

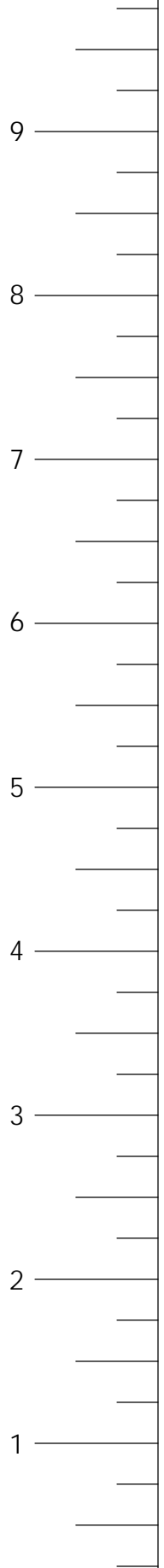

USE THE RULER TO THE RIGHT TO MEASURE YOUR BOLTS AND SCREWS. PICTURE VIEWS SHOWN ABOVE ARE 1:1 SCALE AND CAN BE USED TO MATCH BOLT AND SCREW SIZES.

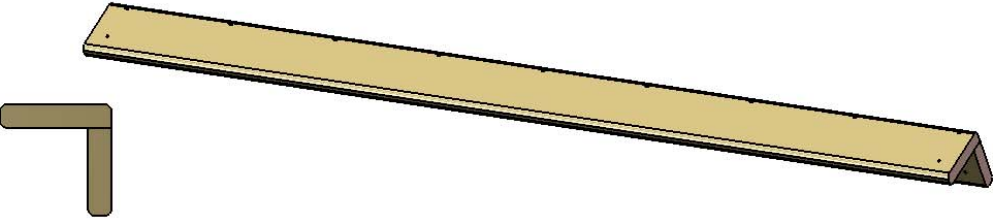
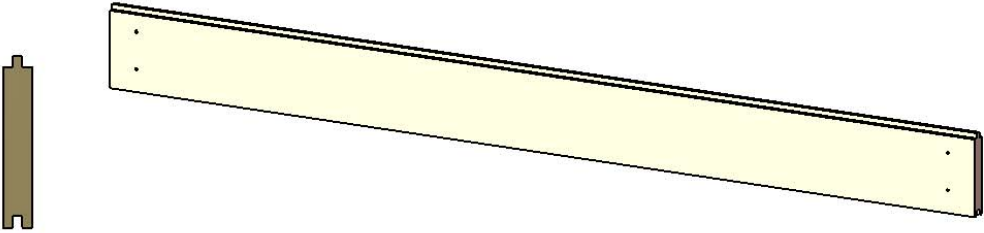
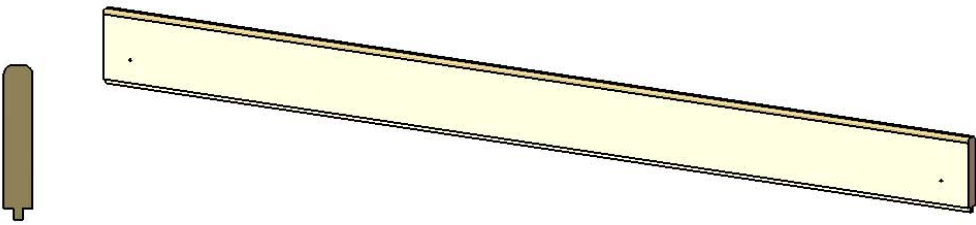
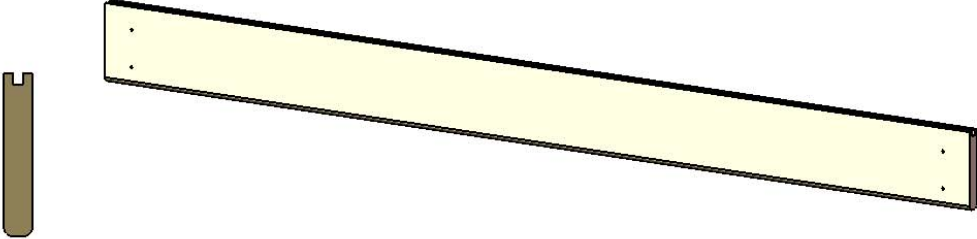
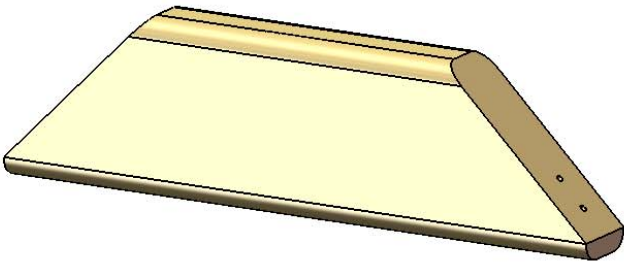
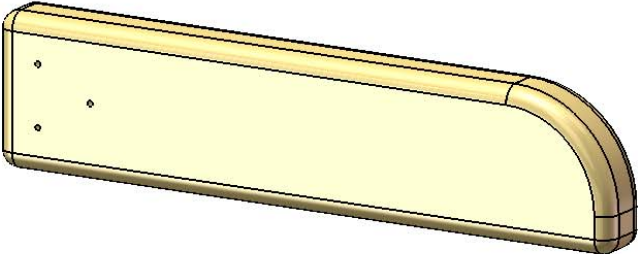
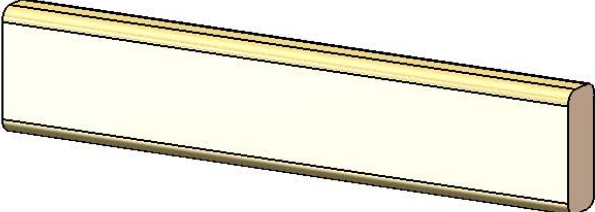
PICTURE	DESCRIPTION	QTY.
	1 X 4 X 52" ROOF PEAK 1-4-5200-RP	<b>1</b>
	1 X 5 X 52" ROOF BOARD 1-5-5200-RB	<b>22</b>
	1 X 4 X 52" ROOF FINISHER 1-4-5200-RF	<b>3</b>
	1 X 4 X 52" ROOF STARTER 1-4-5200-RS	<b>3</b>
	2 X 4 X 13" ANGLE SUPPORT 2-4-1300-AS	<b>10</b>
	2 X 4 X 14-3/4" PICNIC TABLE TOP SUPPORT 2-4-1475-PTTS	<b>2</b>
	2 X 4 X 17" LADDER STEP 2-4-1700-LS	<b>4</b>

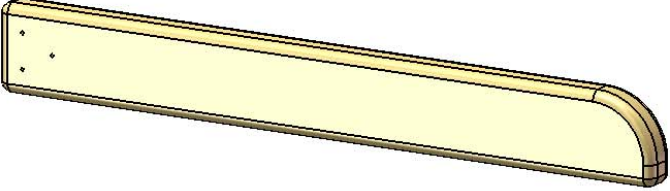
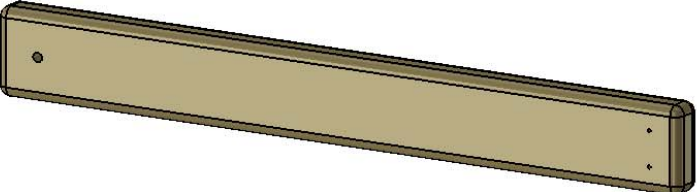
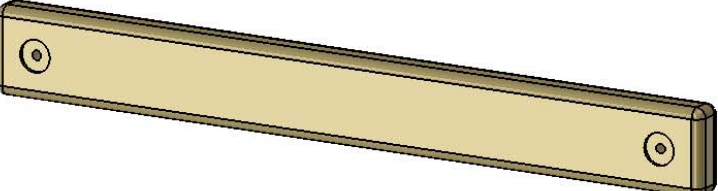
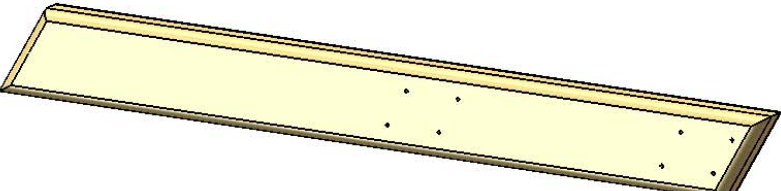
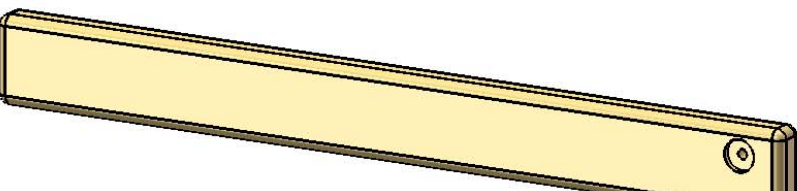
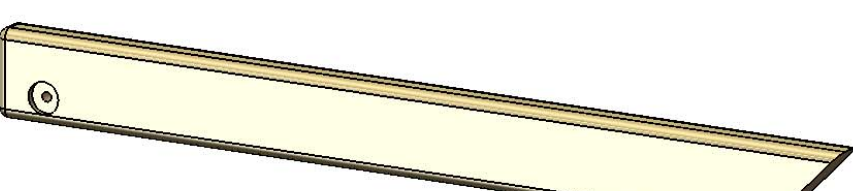
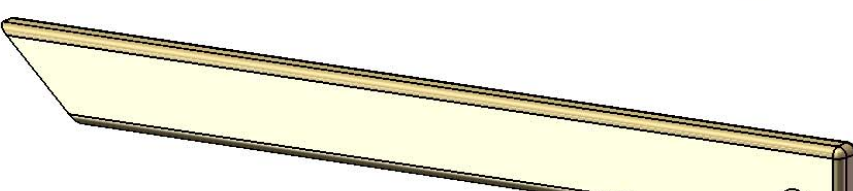
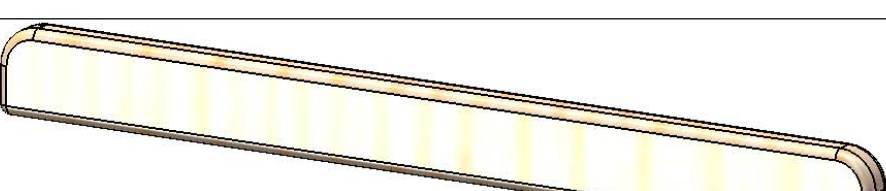
PICTURE	DESCRIPTION	QTY.
	2 X 4 X 27-1/2" PICNIC TABLE SEAT SUPPORT 2-4-2750-PTSS	<b>2</b>
	2 X 4 X 28-11/16" CENTER POST 2-4-2868-CP	<b>1</b>
	2 X 4 X 29-3/4" SLIDE HEADER BOARD 2-4-2975-SHB	<b>1</b>
	2 X 4 X 32-1/2" PICNIC TABLE LEG 2-4-3250-PTL	<b>2</b>
	2 X 4 X 33" TOP PANEL BOARD 2-4-3300-TPB	<b>1</b>
	2 X 4 X 35-1/2" ROOF SUPPORT LEFT 2-4-3550-RSL	<b>2</b>
	2 X 4 X 35-1/2" ROOF SUPPORT RIGHT 2-4-3550-RSR	<b>2</b>
	2 X 4 X 36-3/4" CENTER DECK SUPPORT 2-4-3675-CDS	<b>1</b>

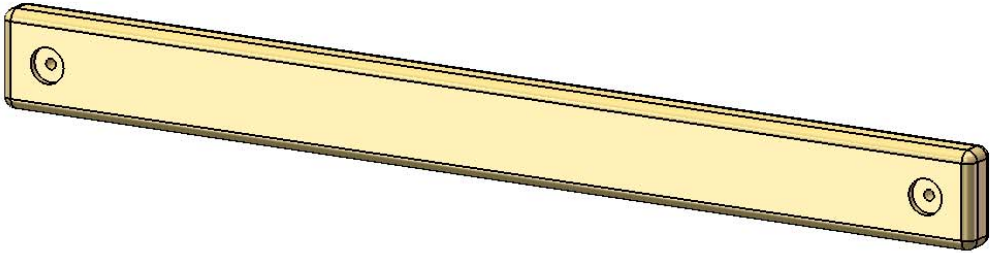
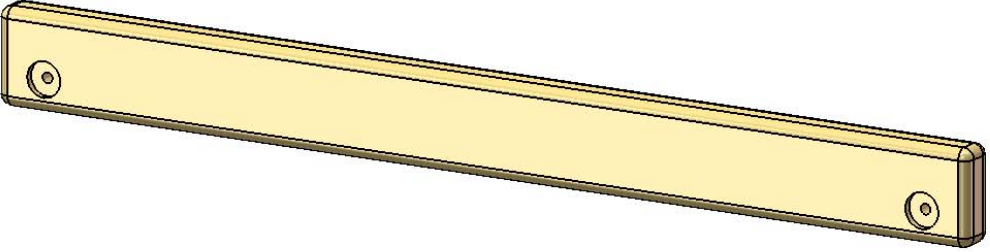
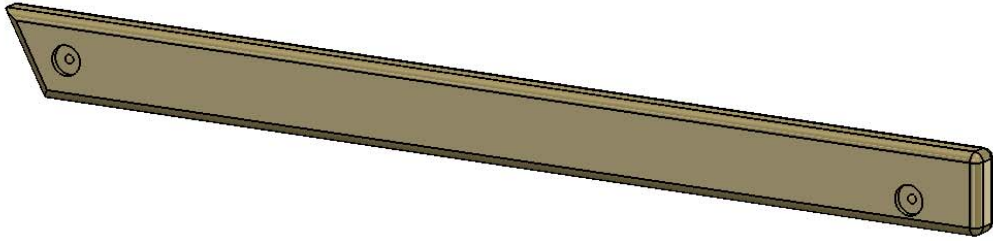
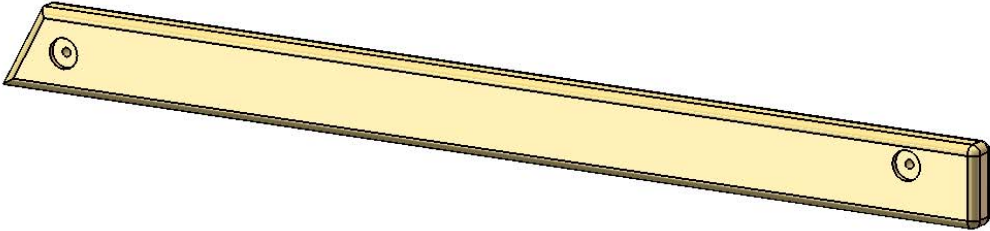
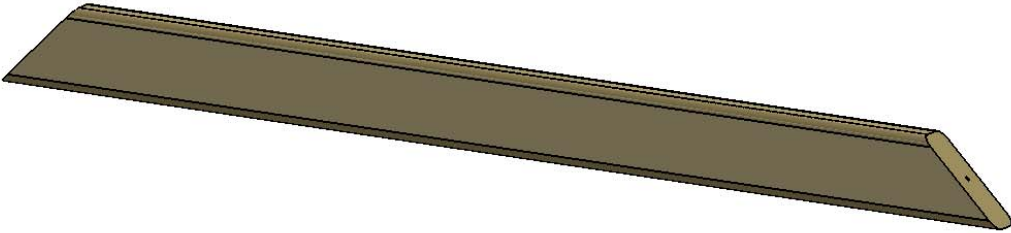
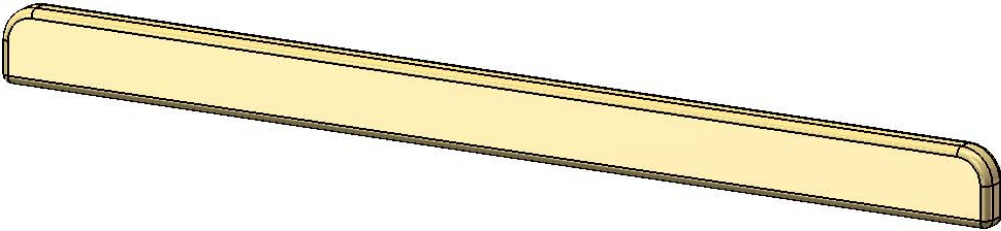
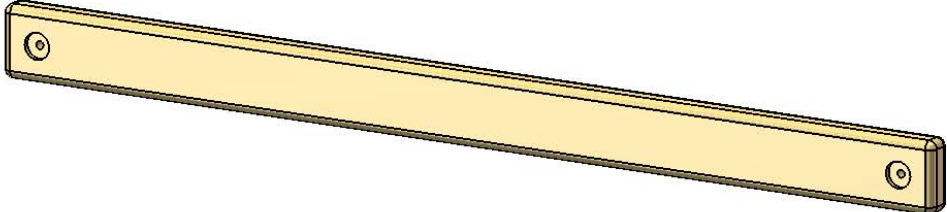
PICTURE	DESCRIPTION	QTY.
	2 X 4 X 36-3/4" DECK SUPPORT 2-4-3675-DS	<b>2</b>
	2 X 4 X 36-3/4" TOP PANEL BOARD 2-4-3675-TPB	<b>1</b>
	2 X 4 X 44" PORCH ROOF SUPPORT LEFT 2-4-4400-PRSL	<b>1</b>
	2 X 4 X 44" PORCH ROOF SUPPORT RIGHT 2-4-4400-PRSR	<b>1</b>
	2 X 4 X 45" SUN BURST SUPPORT 2-4-4500-SBS	<b>2</b>
	2 X 4 X 47-1/2" CENTER DECK SUPPORT 2-4-4750-CDS	<b>1</b>
	2 X 4 X 47-1/2" DECK SUPPORT 2-4-4750-DS	<b>2</b>

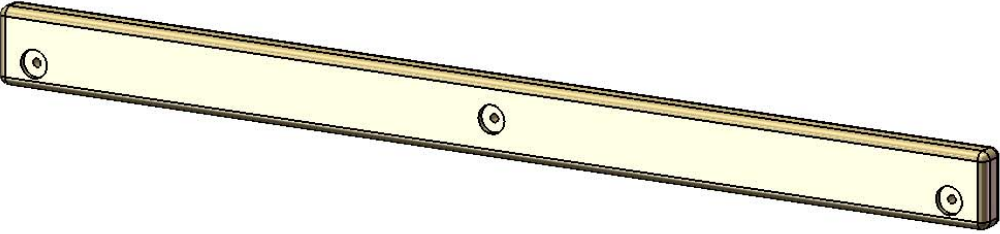
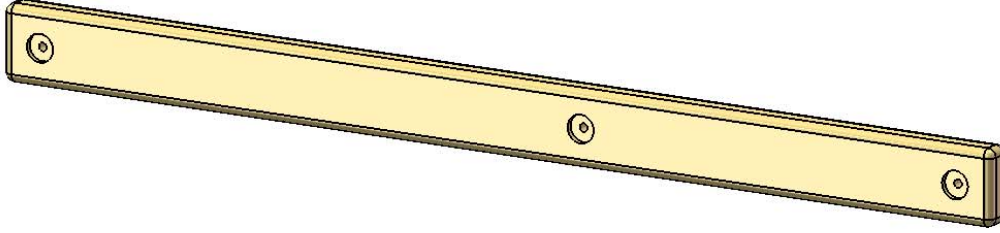
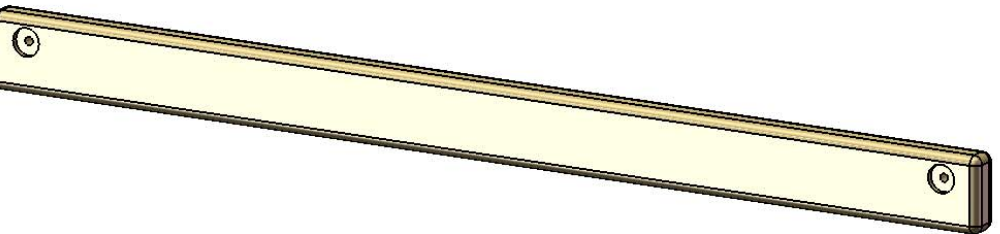
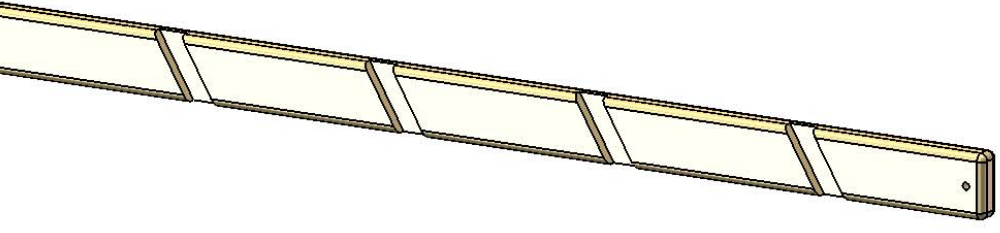
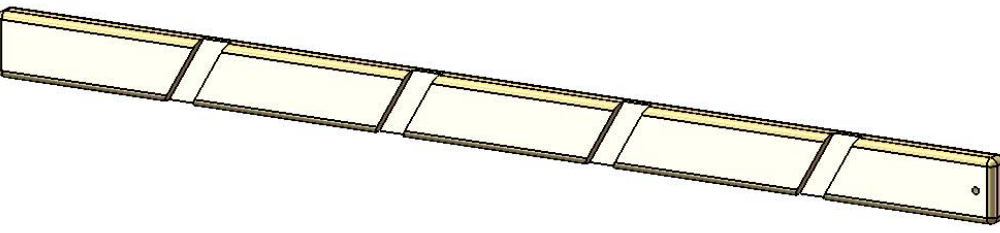
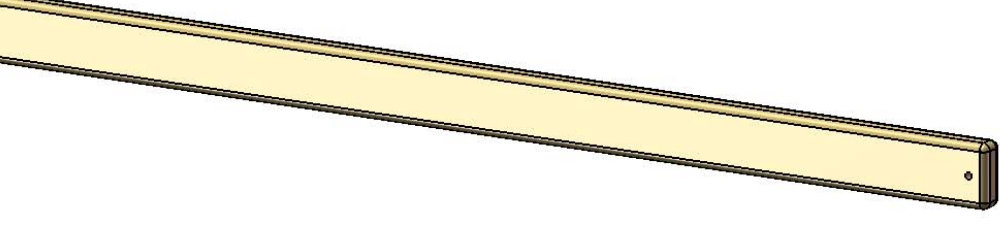
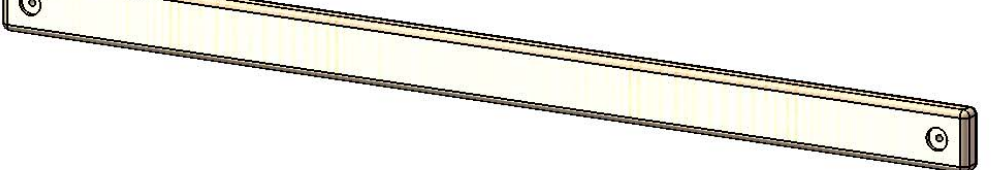

PICTURE	DESCRIPTION	QTY.
	2 X 4 X 47-1/2" MIDDLE PANEL BOARD 2-4-4750-MPB	<b>1</b>
	2 X 4 X 47-1/2" RADRIDE TOP PANEL BOARD 2-4-4750-RTPB	<b>1</b>
	2 X 4 X 47-1/2" TOP PANEL BOARD/PORCH SAFETY BOARD/SAFETY BOARD 2-4-4750-TPB	<b>6</b>
	2 X 4 X 57" LADDER LEFT SIDE 2-4-5700-LLS	<b>1</b>
	2 X 4 X 57" LADDER RIGHT SIDE 2-4-5700-LRS	<b>1</b>
	2 X 4 X 57" ROCK WALL SIDE 2-4-5700-RWS	<b>2</b>
	2 X 4 X 58" CROSS MEMBER 2-4-5800-CM	<b>1</b>

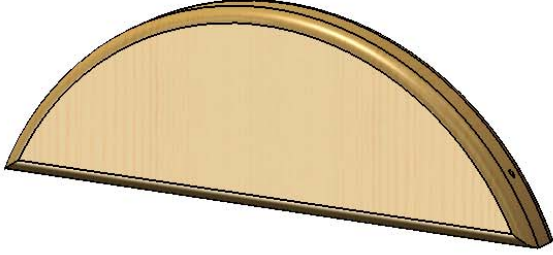
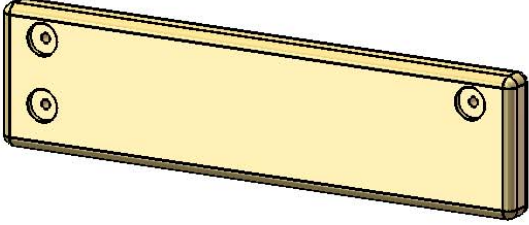
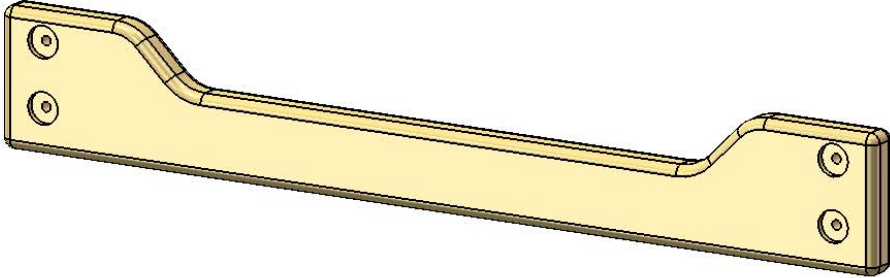
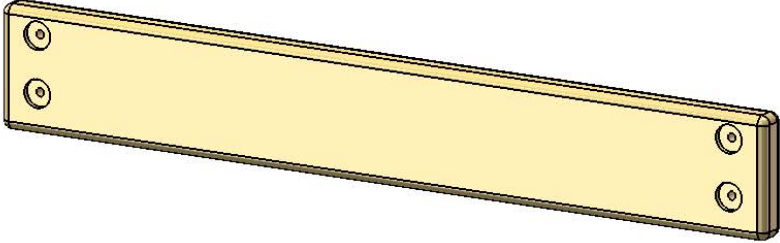
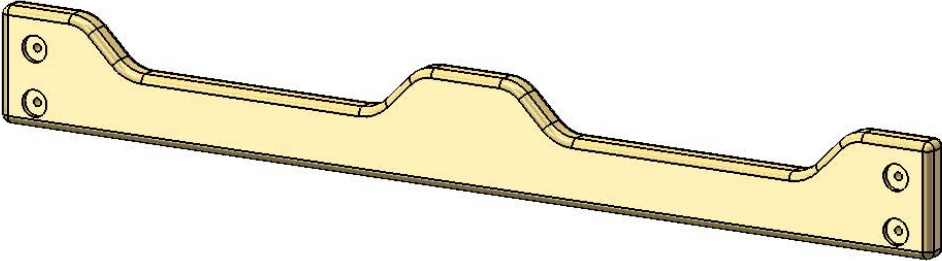
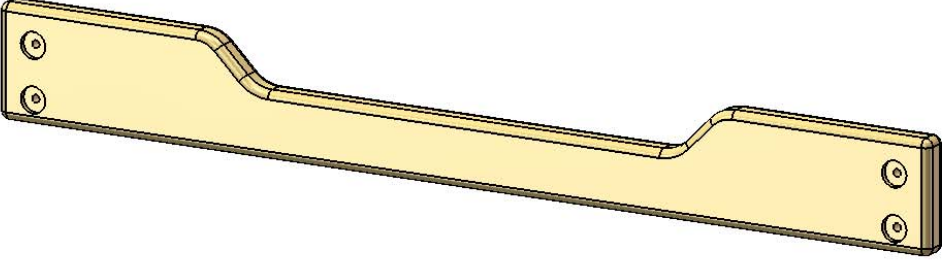
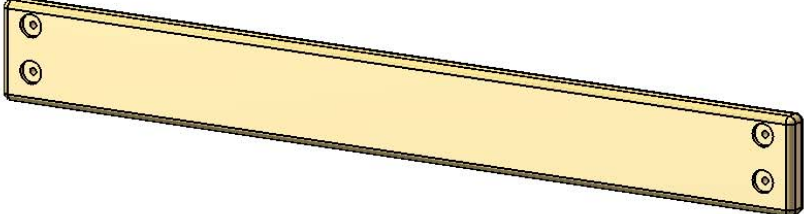
PICTURE	DESCRIPTION	QTY.
	2 X 6 X 16" SUN 2-6-1600-S	<b>2</b>
	2 X 6 X 21-1/2" RADRIDE EXIT BOARD 2-6-2150-REB	<b>1</b>
	2 X 6 X 36-3/4" ROCK WALL ENTRANCE BOARD 2-6-3675-RWEB	<b>1</b>
	2 X 6 X 36-3/4" BOTTOM PANEL BOARD 2-6-3675-BPB	<b>1</b>
	2 X 6 X 47-1/2" ENTRANCE BOARD 2-6-4750-EB	<b>1</b>
	2 X 6 X 47-1/2" LADDER ENTRANCE BOARD 2-6-4750-LEB	<b>1</b>
	2 X 6 X 47-1/2" SAND BOX BOARD 2-6-4750-SB	<b>5</b>

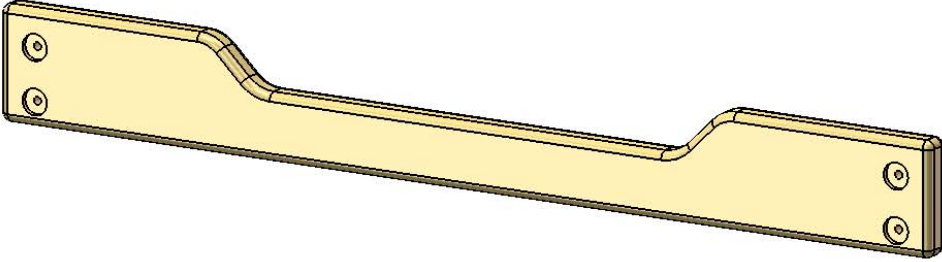
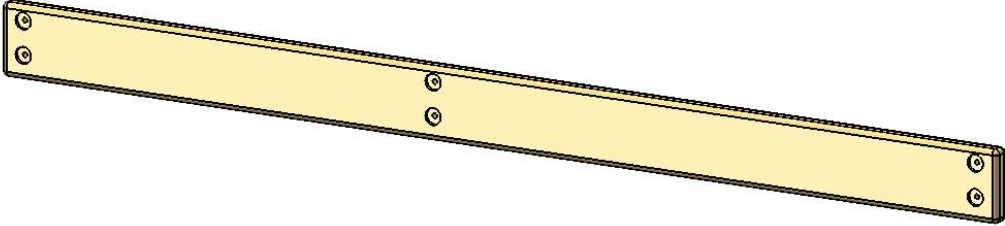
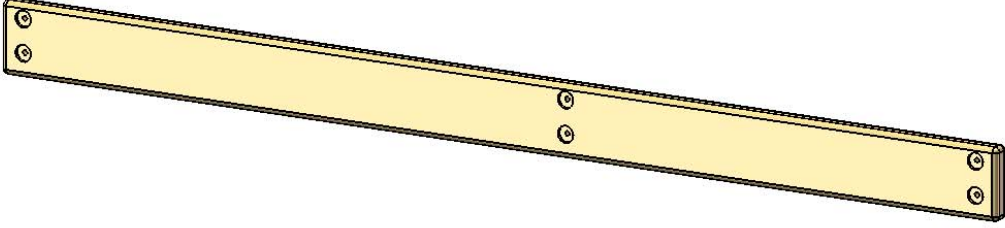
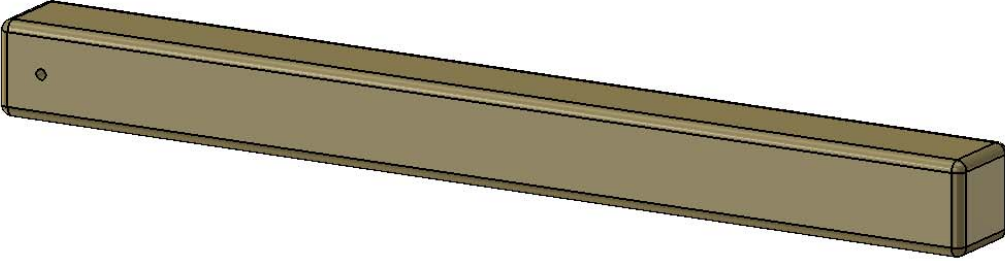
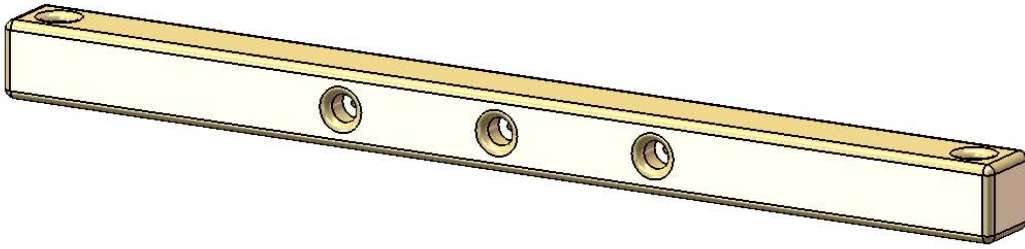
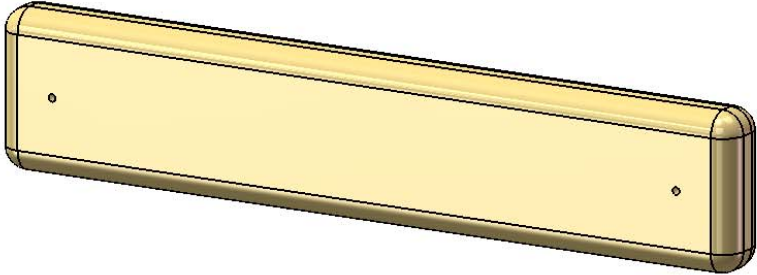
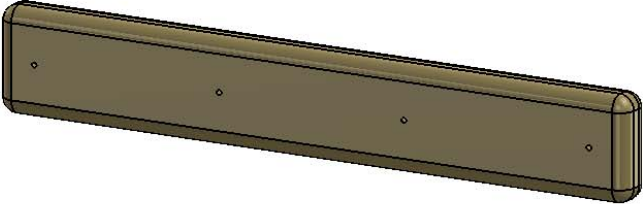

PICTURE	DESCRIPTION	QTY.
	<p>2 X 6 X 47-1/2" SLIDE EXIT BOARD 2-6-4750-SEB</p>	<p><b>1</b></p>
	<p>2 X 6 X 80-3/4" SAND BOX BOARD FRONT 2-6-8075-SBF</p>	<p><b>1</b></p>
	<p>2 X 6 X 80-3/4" SAND BOX BOARD REAR 2-6-8075-SBR</p>	<p><b>1</b></p>
	<p>4 X 4 X 37-5/8" RAD RIDE POST 4-4-3763-RP</p>	<p><b>1</b></p>
	<p>4 X 4 X 47-1/2" SWING BEAM MOUNT 4-4-4750-SBM</p>	<p><b>1</b></p>
	<p>5/4 X 3 X 13-1/4" PICNIC TABLE SLAT 125-3-1325-PTS</p>	<p><b>2</b></p>
	<p>5/4 X 3 X 17" WINDOW STRINGER 125-3-1700-WS</p>	<p><b>3</b></p>

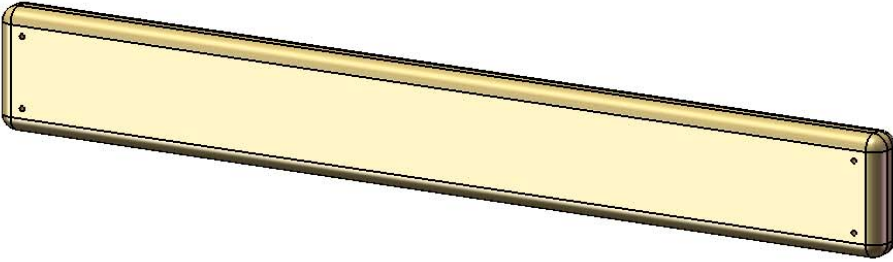
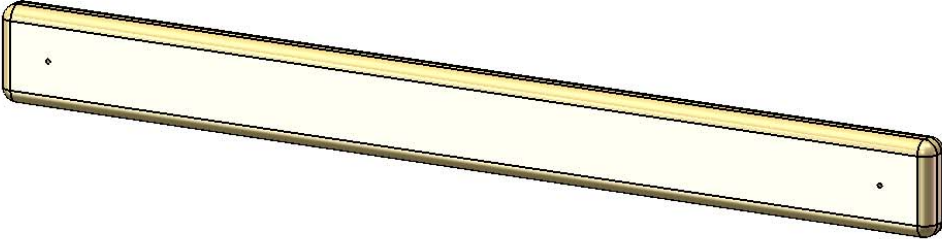
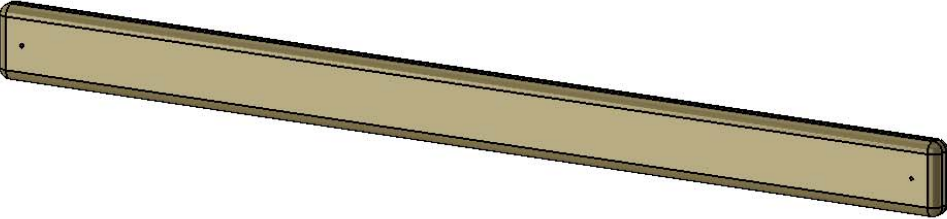
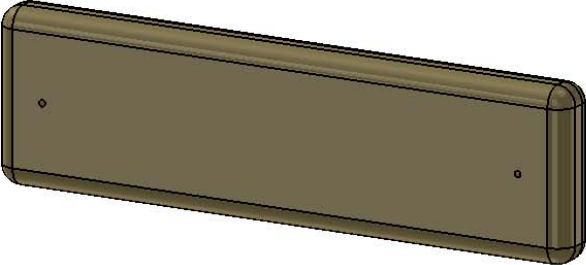
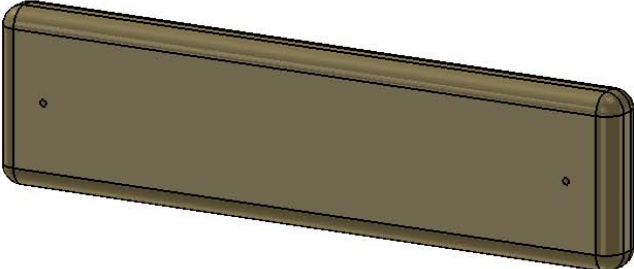
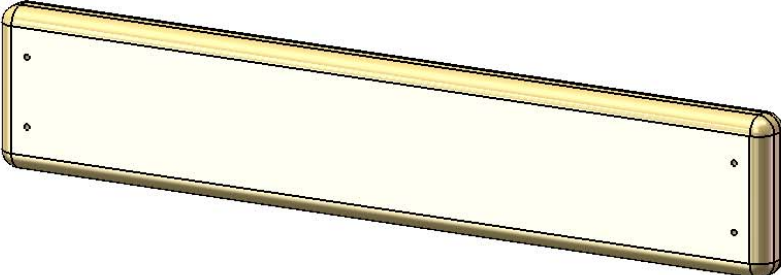
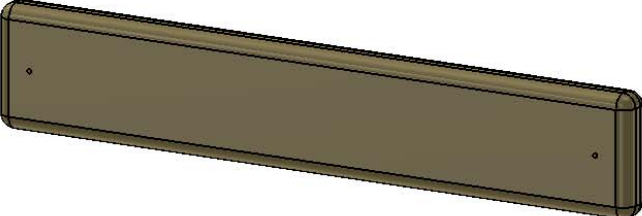
PICTURE	DESCRIPTION	QTY.
	5/4 X 3 X 23-7/8" ROCK WALL TOP CAP 125-3-2388-RWTC	<b>1</b>
	5/4 X 3 X 28" PANEL SLAT 125-3-2800-PS	<b>9</b>
	5/4 X 3 X 36-3/4" PANEL SLAT 125-3-3675-PS	<b>2</b>
	5/4 X 4 X 12" SUN RAY 125-4-1200-SR	<b>4</b>
	5/4 X 4 X 13" SUN RAY 125-4-1300-SR	<b>4</b>
	5/4 X 4 X 18-1/2" LADDER BACK 125-4-1850-LB	<b>1</b>
	5/4 X 4 X 19" SUN RAY 125-4-1900-SR	<b>2</b>

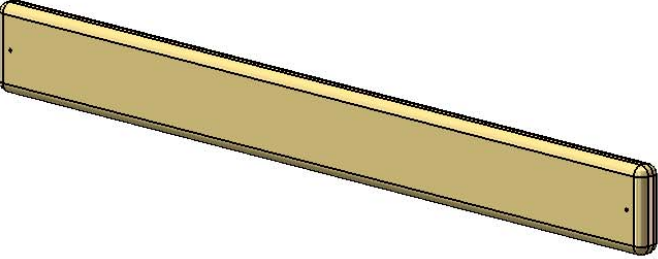
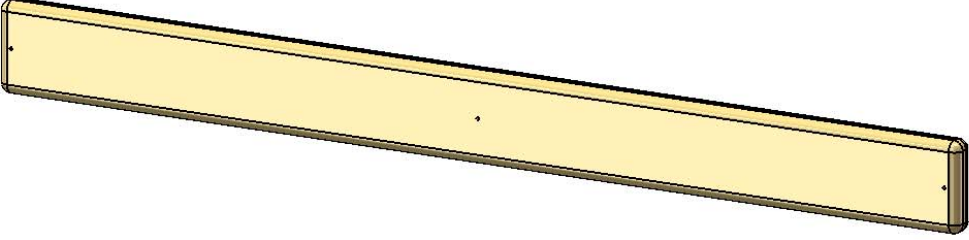
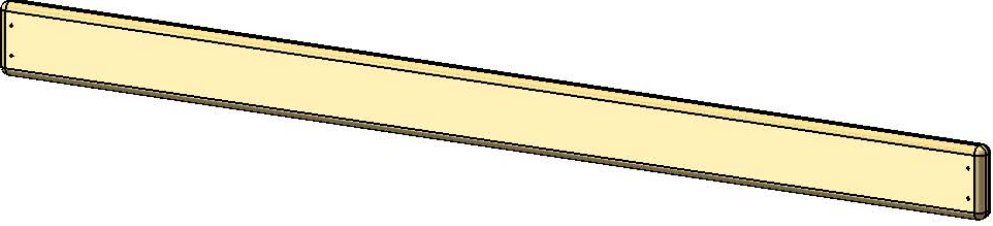
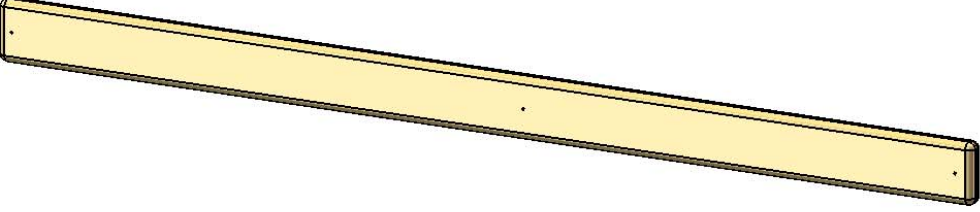
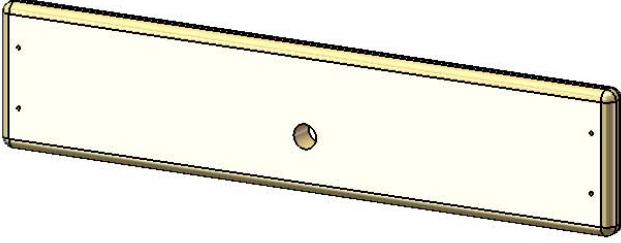
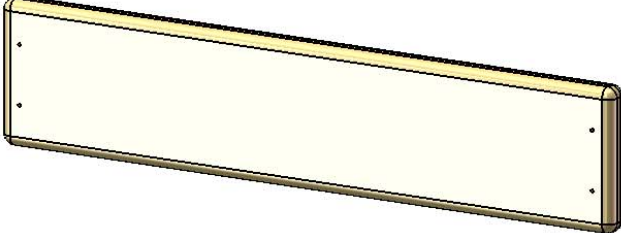
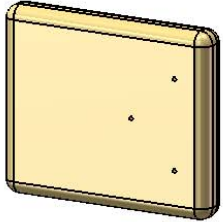
PICTURE	DESCRIPTION	QTY.
	5/4 X 4 X 33-1/4" WINDOW PANEL BOARD 125-4-3325-WPB	<b>2</b>
	5/4 X 4 X 40-3/8" DECK SPACER 125-4-4038-DS	<b>4</b>
	5/4 X 4 X 50-1/4" ROOF END CAP 125-4-5025-REC	<b>1</b>
	5/4 X 4 X 58-1/2" WINDOW PANEL BOARD 125-4-5850-WPB	<b>2</b>
	5/4 X 5 X 23-7/8" BOTTOM ROCK WALL BOARD 125-5-2388-BRWB	<b>1</b>
	5/4 X 5 X 23-7/8" ROCK WALL BOARD 125-5-2388-RWB	<b>10</b>
	5/4 X 6 X 6-1/2" WINDOW UNDER 125-6-0650-WU	<b>2</b>

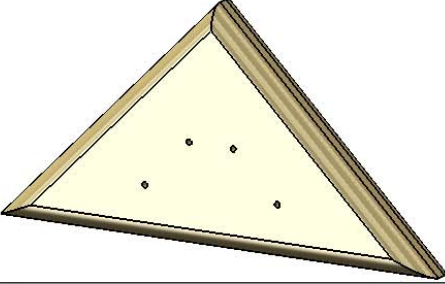
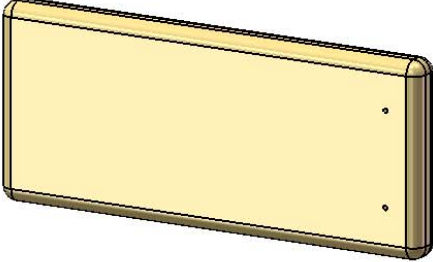
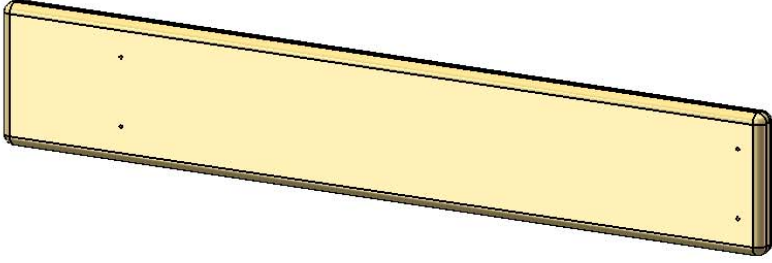
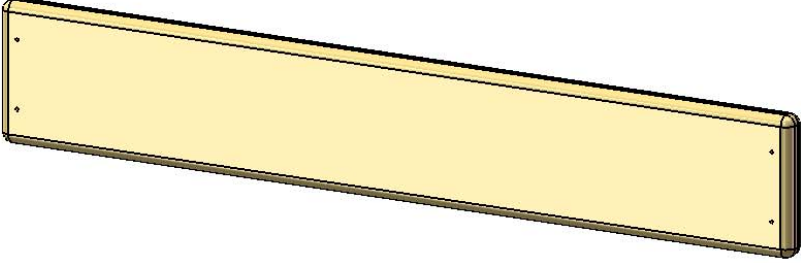
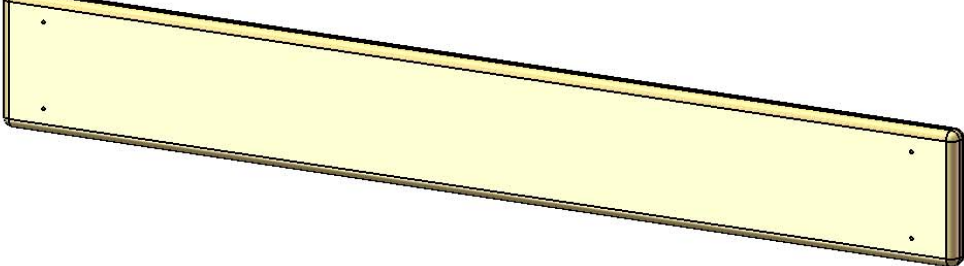
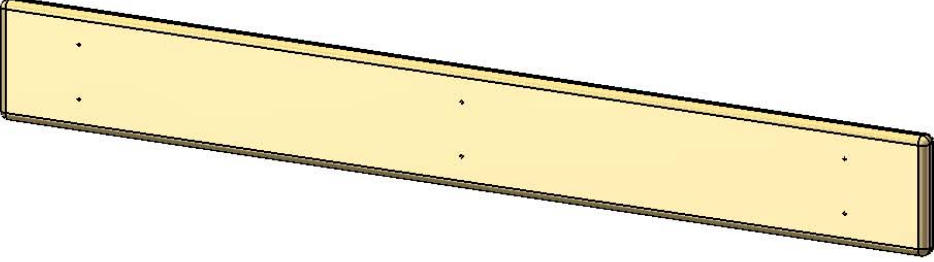
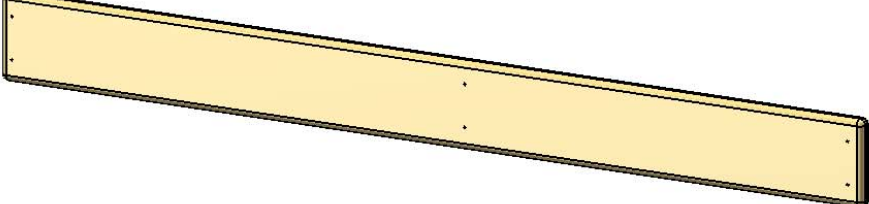
PICTURE	DESCRIPTION	QTY.
	5/4 X 6 X 10-1/2" ROOF PEAK SUPPORT 125-6-1050-RPS	<b>2</b>
	5/4 X 6 X 12-5/8" WINDOW ABOVE 125-6-1263-WA	<b>6</b>
	5/4 X 6 X 32" WINDOW UNDER 125-6-3200-WU	<b>4</b>
	5/4 X 6 X 33-1/4" WINDOW PANEL BOARD 125-6-3325-WPB	<b>2</b>
	5/4 X 6 X 43" PICNIC TABLE TOP AND SEAT BOARD 125-6-4300-PTTS	<b>4</b>
	5/4 X 6 X 47-3/8" DECK BOARD 125-6-4738-DB	<b>12</b>
	5/4 X 6 X 58-1/2" WINDOW PANEL BOARD 125-6-5850-WPB	<b>4</b>

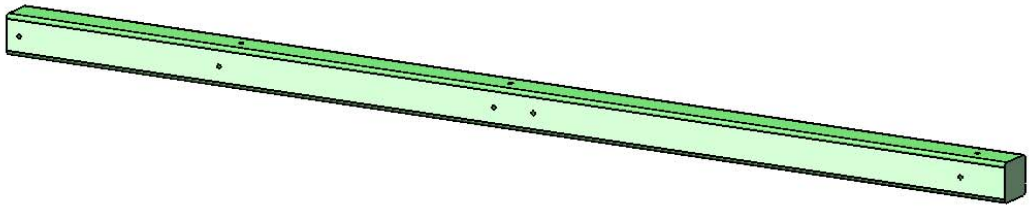
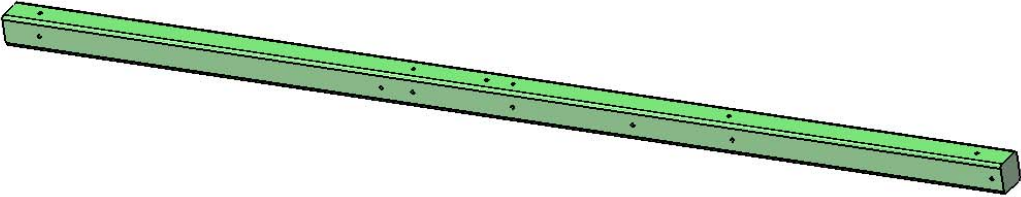
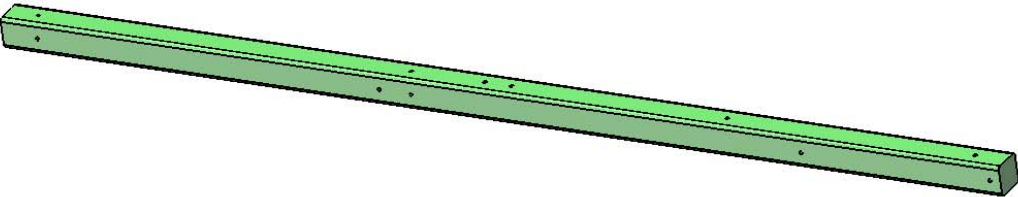
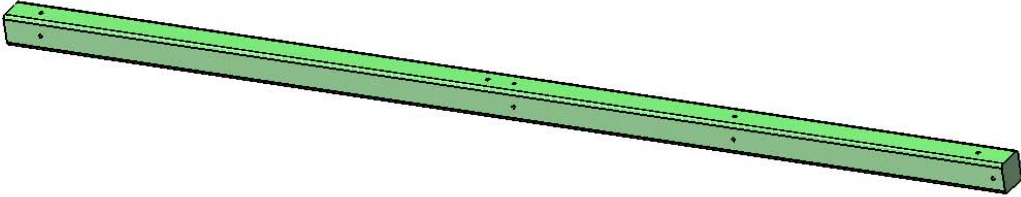
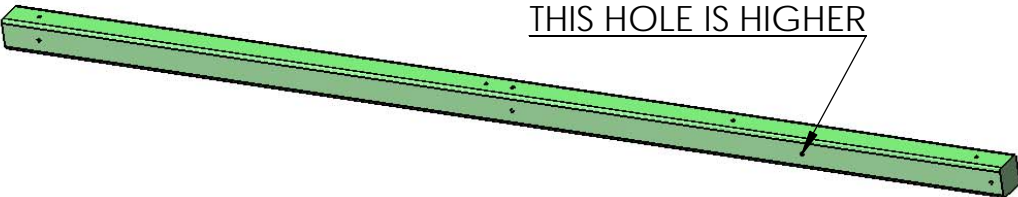
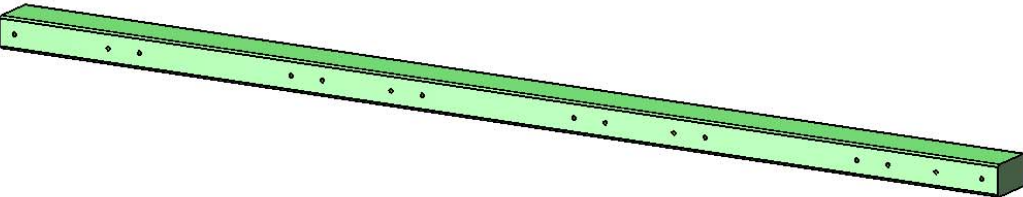
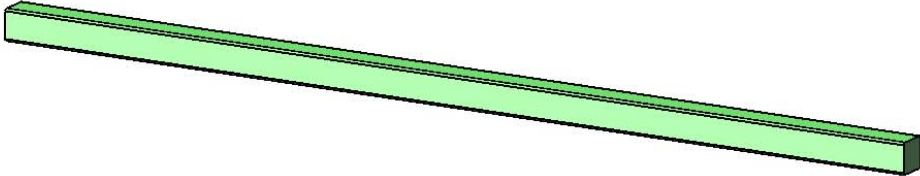

PICTURE	DESCRIPTION	QTY.
	4 X 4 X 96" PORCH CORNER POST	<b>2</b>
	4 X 4 X 120" MIDDLE - FRONT CORNER POST	<b>1</b>
	4 X 4 X 120" MIDDLE - REAR CORNER POST	<b>1</b>
	4 X 4 X 120" END - FRONT CORNER POST	<b>1</b>
	4 X 4 X 120" END - REAR CORNER POST	<b>1</b>
	4 X 6 X 120" SWING BEAM	<b>1</b>
	4 X 4 X 108" SWING LEG	<b>2</b>

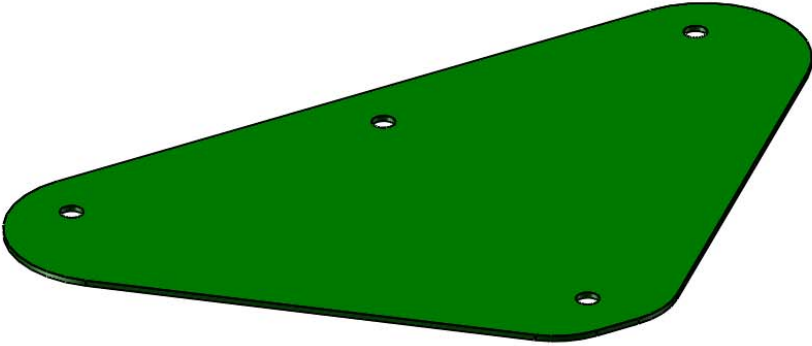
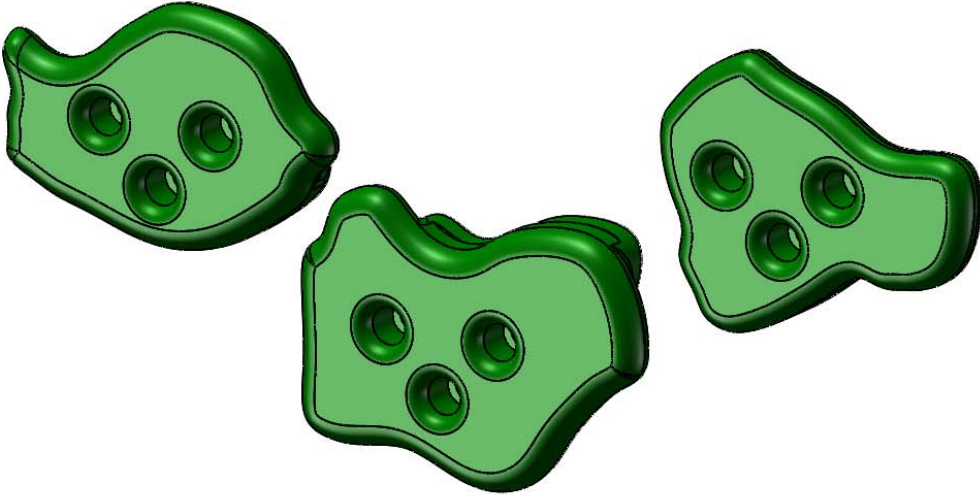
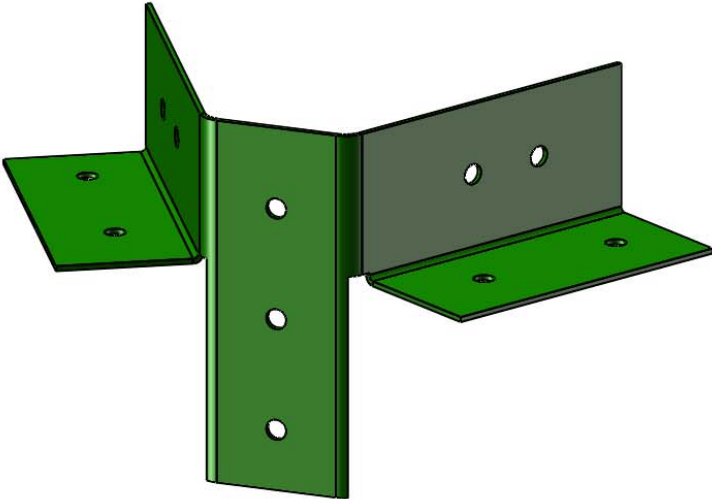

PICTURE	DESCRIPTION	QTY.
	<p>SWING PLATE <b>11-5002</b></p>	<p>1</p>
	<p>CLIMBING ROCKS (5 ROCKS ARE IN ONE BAG) <b>07-0008</b></p>	<p>10</p>
	<p>A-FRAME SWING LEG BRACKET <b>11-5010</b></p>	<p>1</p>
<p>(NOT SHOWN) HARDWARE BOX: 1300</p>	<p>HARDWARE BOX INSTRUCTIONS</p>	<p>1 1</p>

PICTURE

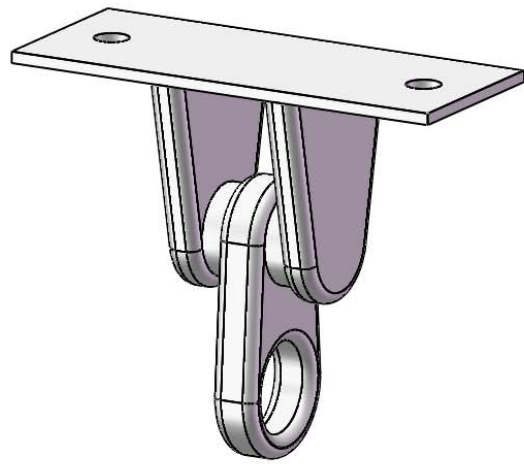

DESCRIPTION

IRON  
DUCTILE  
SWING  
HANGER  
11-4012

QTY.

6

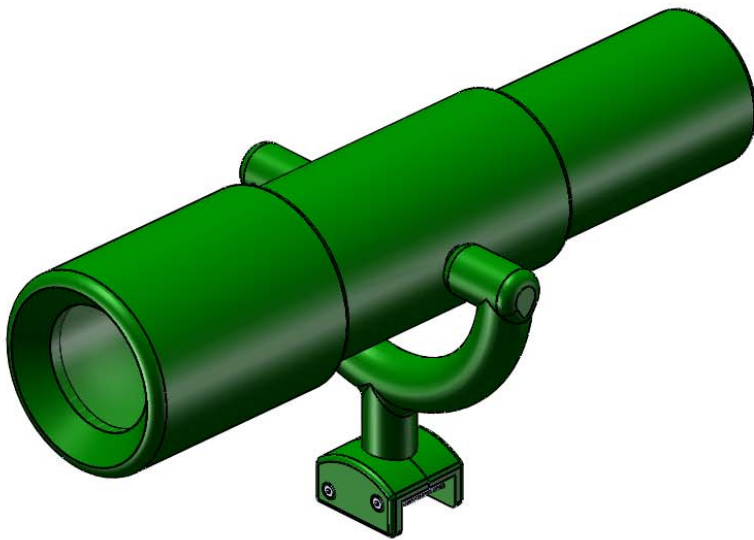

TELESCOPE  
07-0001

1

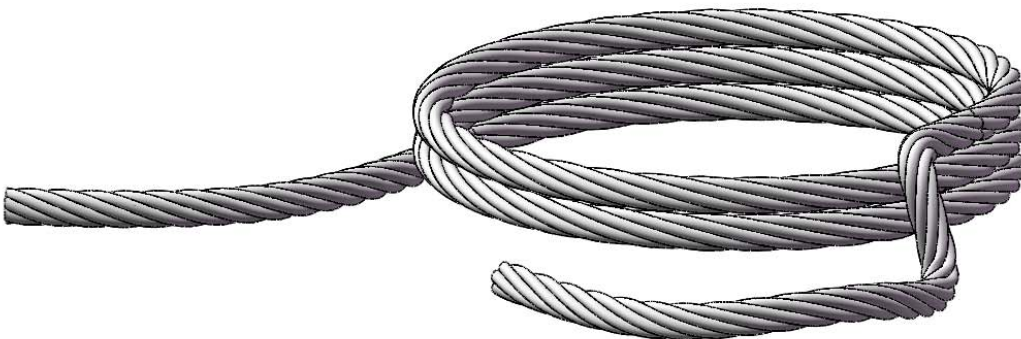

10'  
ROCK  
WALL  
ROPE

1



PICTURE

DESCRIPTION

QTY.

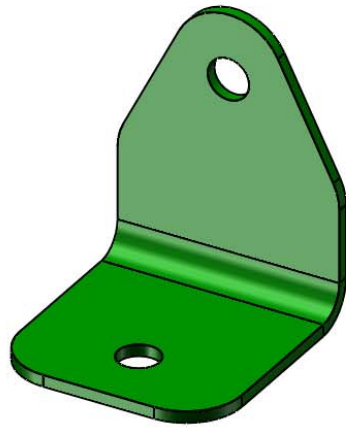

90°  
BRACKET  
11-5013

4

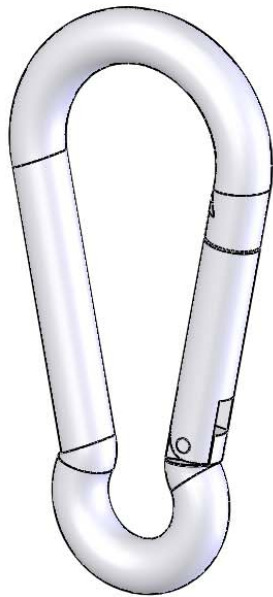

SPRING  
CLIP  
11-4003

6

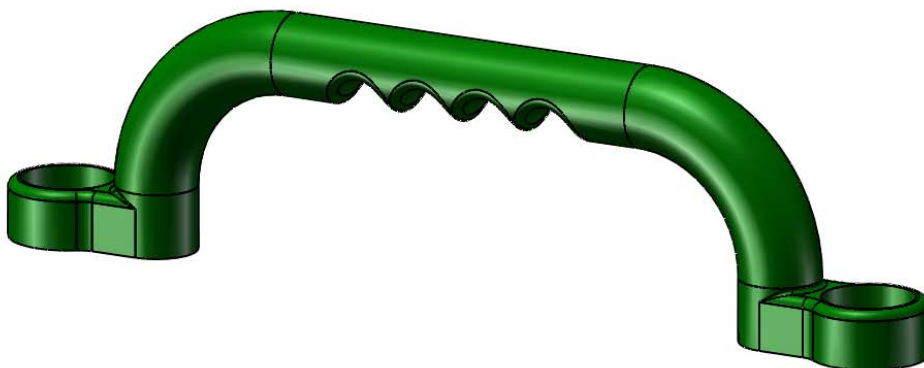

SAFETY  
HANDLE  
(2 HANDLES  
ARE IN ONE  
BAGPAIR)  
07-0005

4

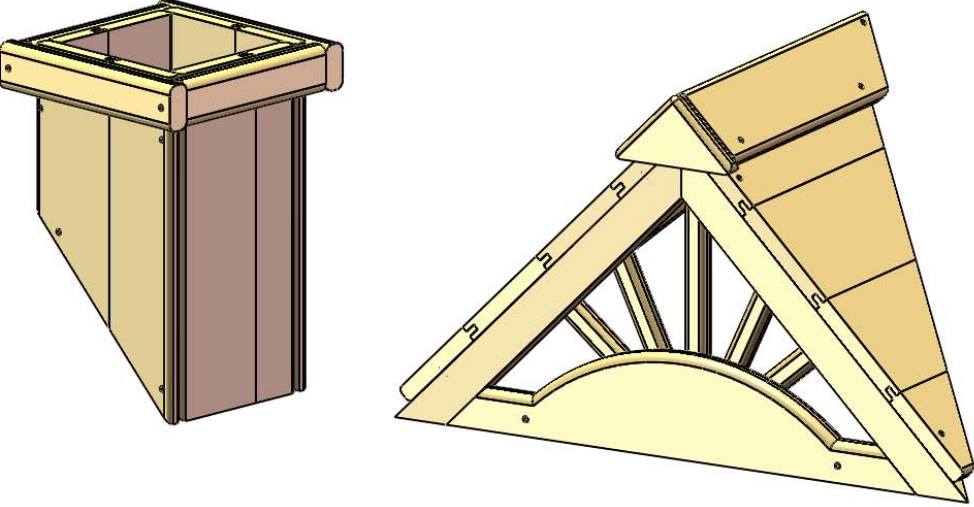
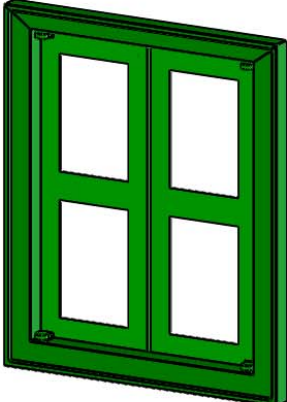
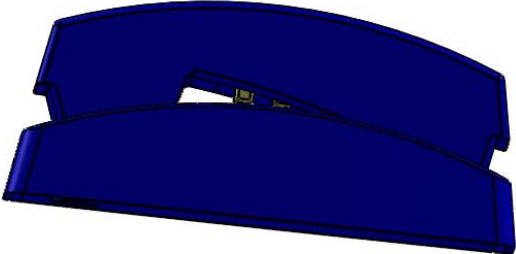
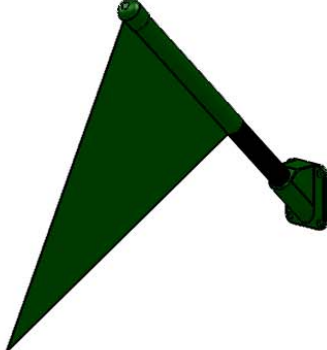
PICTURE	DESCRIPTION	QTY.
 <p>The image shows two 3D perspective drawings of wooden structures. On the left is a chimney with a square top and four vertical panels. On the right is a dormer with a gabled roof and a semi-circular window opening at the base.</p>	<p>CHIMNEY (UNASSEMBLED) IN 110 BOX</p> <p>DORMER (UNASSEMBLED) IN 110 BOX</p>	<p>1</p> <p>2</p>
 <p>A 3D perspective drawing of a green window frame with four rectangular panes arranged in a 2x2 grid.</p>	<p>WINDOW 07-0013</p>	<p>3</p>
 <p>A 3D perspective drawing of a blue telephone handset, shown from a side-top angle.</p>	<p>TELEPHONE 07-0014</p>	<p>1</p>
 <p>A 3D perspective drawing of a green flag on a black pole with a decorative finial.</p>	<p>FLAG KIT 09-1014</p>	<p>2</p>

PICTURE	DESCRIPTION	QTY.
	<p>CROWN 07-0019</p>	<p>4</p>
<p>(NOT SHOWN)</p>	<p>NAME PLATE</p>	<p>1</p>
	<p>GROUND STAKE (2 STAKES ARE IN ONE BAG) 07-0016</p>	<p>1</p>
	<p>TIC TAC TOE (UNASSEMBLED) 07-0010</p> <p>TIC TAC TOE BOARDS 1-3/8 X 1-5/8 X 10-5/8"</p>	<p>1</p>
	<p>BINOCULARS 07-0003</p>	<p>1</p>
	<p>CHALK BOARD 07-0018</p>	<p>1</p>
	<p>TOY CHEST (UNASSEMBLED) 01-5013</p>	<p>1</p>

# STEP 1: ATTACHING T-NUTS TO THE PORCH CORNER POSTS

- 1: THIS STEP IS CRITICAL TO BUILDING THE FORT PROPERLY. IF ANY MISTAKES ARE MADE HERE, YOU WILL NEED TO DIS-ASSEMBLE AND THEN RE-ASSEMBLE TO MAKE YOUR CORRECTIONS.
- 2: MAKE SURE HOLES ARE FREE OF ANY OBSTRUCTIONS. USE A BOLT TO CLEAN OUT ANY DEBRIS.
- 3: LAY OUT EACH OF THE 4 X 4 X 96" PORCH CORNER POSTS IN THE AREA YOU INTENDED ON BUILDING THE FORT SIDE OF THE PLAY SET.
- 4: USE THE DIAGRAM BELOW TO CORRECTLY IDENTIFY AND ORIENT THE NECESSARY DIRECTION THE POSTS SHOULD FACE.
- 5: USE A HAMMER TO SEAT THE T-NUTS AFTER INSERTING THEM INTO THE HOLES SHOWN IN THE DIAGRAM BELOW.
- 6: THE BARREL OF THE T-NUT SHOULD GO INTO THE HOLE FIRST. HAMMER THE T-NUT UNTIL IT IS FLUSH / ALMOST FLUSH TO THE CORNER POSTS.

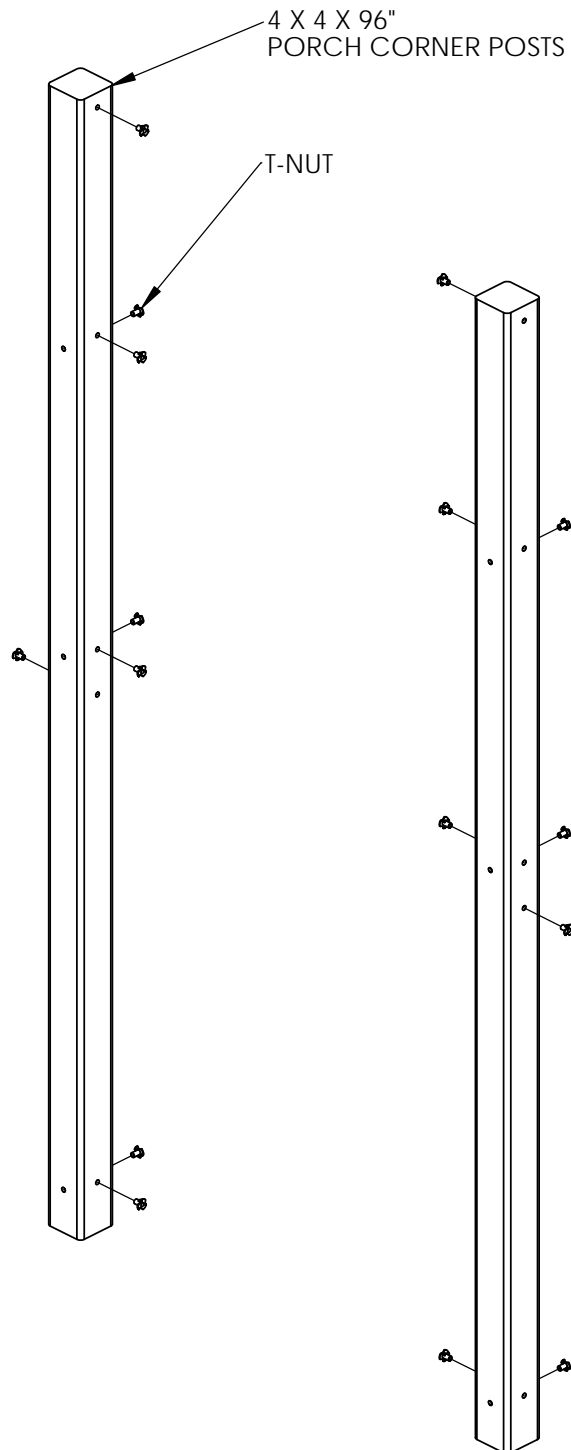

## STEP 2: ASSEMBLING THE PORCH FRAME

1: LAY THE CORNER POSTS ON THE GROUND IN THEIR PROPER ORIENTATION (USE DIAGRAM BELOW TO CORRECTLY IDENTIFY AND ORIENT THE NECESSARY DIRECTION THE POSTS SHOULD FACE).

2: LAY THE 2 X 6 X 47-1/2" SANDBOX BOARD ON TOP OF THE CORNER POSTS, THE HOLES IN THE SANDBOX BOARD ARE OFFSET DOWN, AND SHOULD BE ALIGNED WITH THE CORNER POSTS BOTTOM MOST HOLES.

3: USE 5/16" X 4-1/2" HEX BOLTS AND 5/16" WASHERS TO ATTACH THE TOP HOLES OF THE SANDBOX BOARD TO THE T-NUTS INSTALLED IN THE CORNER POSTS. THE SANDBOX BOARD BOTTOM HOLES WILL BE USED LATER.

4: LAY THE 2 X 6 X 47-1/2" LADDER ENTRANCE BOARD ON TOP OF THE CORNER POSTS (USE DIAGRAM BELOW TO CORRECTLY MOUNT THE LADDER ENTRANCE BOARD) THE HOLES IN THE ENTRANCE BOARD ARE OFFSET DOWN. ALIGN THE TOP HOLES WITH THE CORNER POSTS CENTER HOLES AND USE THE 5/16" X 4-1/2" HEX BOLTS TO ATTACH TO THE T-NUTS INSTALLED IN THE CORNER POSTS.

5: LAY THE 2 X 4 X 47-1/2" TOP PANEL BOARD ON TOP OF THE CORNER POSTS, THE HOLES IN THE TOP PANEL BOARD ARE OFFSET DOWN, AND SHOULD BE ALIGNED WITH THE TOP HOLES OF THE CORNER POSTS AS SHOWN BELOW. USE 5/16" X 4-1/2" HEX BOLTS TO ATTACH THE TOP PANEL BOARD TO THE T-NUTS INSTALLED IN THE CORNER POSTS.

6: USE A CARPENTERS SQUARE TO SQUARE THE BOARDS TO THE POSTS.

7: ONCE THE FRAME IS SQUARE USE THE 5/16" X 3-1/2" LAG SCREWS AND 5/16" WASHERS TO KEEP THE FRAME FROM MOVING OUT OF SQUARE.

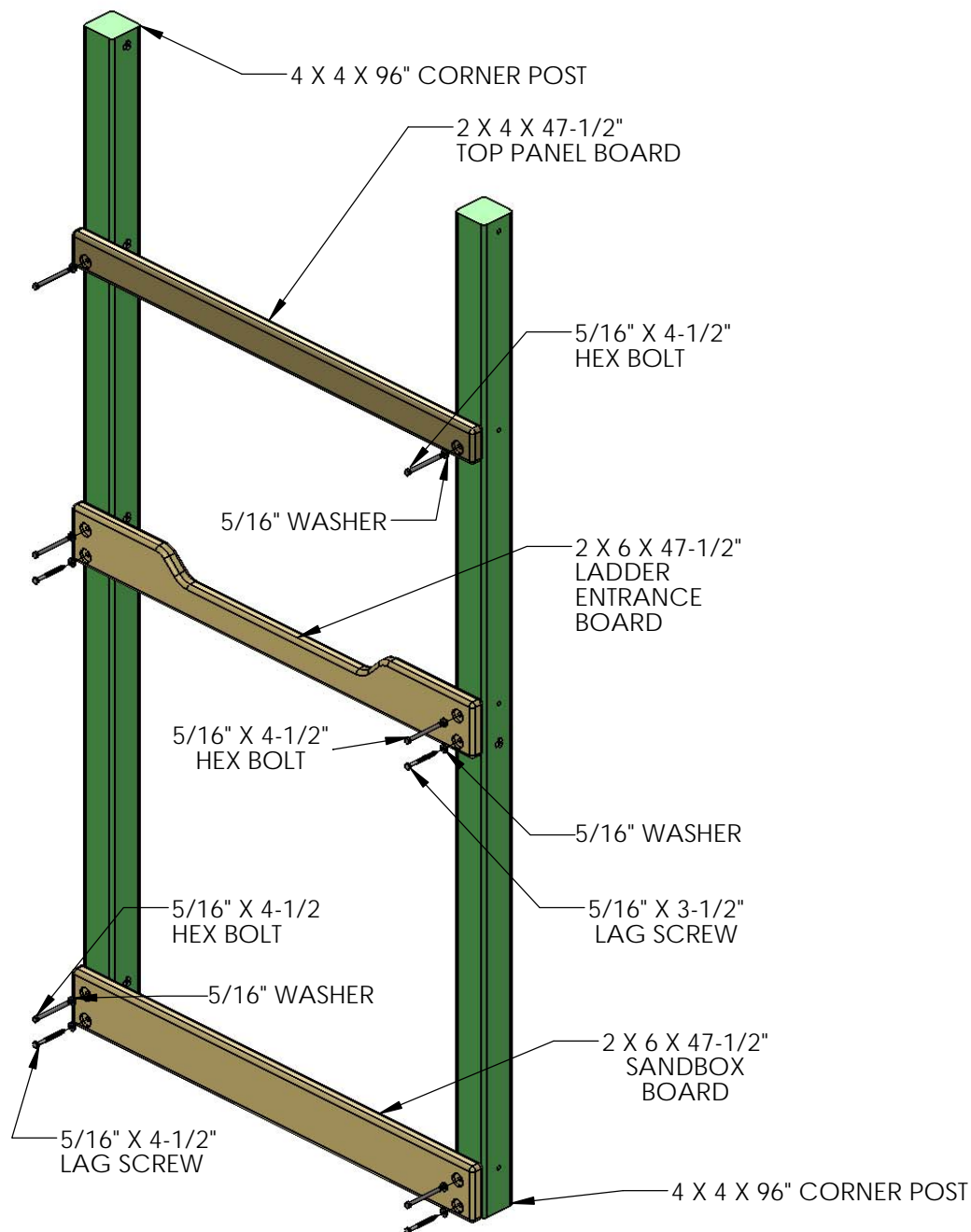

## STEP 3: ATTACHING THE T-NUTS TO THE MIDDLE CORNER POSTS

1: THIS STEP IS CRITICAL TO BUILDING THE FORT PROPERLY. IF ANY MISTAKES ARE MADE HERE, YOU WILL NEED TO DIS-ASSEMBLE AND THEN RE-ASSEMBLE TO MAKE YOUR CORRECTIONS.

2: MAKE SURE HOLES ARE FREE OF ANY OBSTRUCTIONS. USE A BOLT TO CLEAN OUT ANY DEBRIS.

3: LAY OUT EACH OF THE 4 X 4 X 120" MIDDLE CORNER POSTS IN THE AREA YOU INTENDED ON BUILDING THE FORT SIDE OF THE PLAY SET.

4: USE THE DIAGRAM BELOW TO CORRECTLY IDENTIFY AND ORIENT THE NECESSARY DIRECTION THE POSTS SHOULD FACE.

5: USE A HAMMER TO SEAT THE T-NUTS AFTER INSERTING THEM INTO THE HOLES SHOWN IN THE DIAGRAM BELOW.

6: THE BARREL OF THE T-NUT SHOULD GO INTO THE HOLE FIRST. HAMMER THE T-NUT UNTIL IS FLUSH / ALMOST FLUSH TO THE CORNER POSTS.

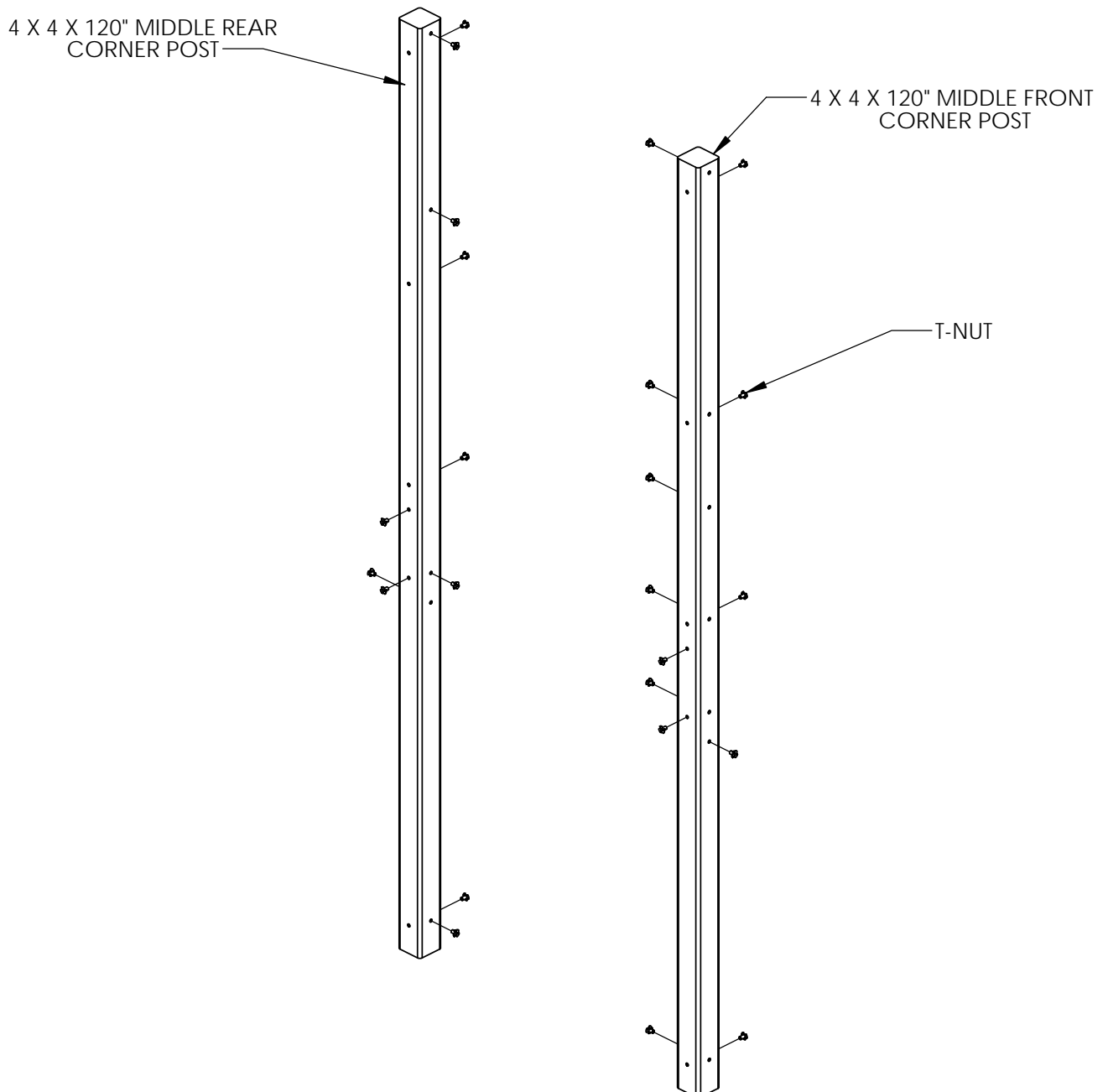

## STEP 4: ASSEMBLING THE MIDDLE FRAME

1: LAY THE CORNER POSTS ON THE GROUND IN THEIR PROPER ORIENTATION (USE DIAGRAM BELOW TO CORRECTLY IDENTIFY AND ORIENT THE NECESSARY DIRECTION THE POSTS SHOULD FACE).

2: LAY THE 2 X 6 X 47-1/2" SANDBOX BOARD ON TOP OF THE CORNER POSTS, THE HOLES IN THE SANDBOX BOARD ARE OFFSET DOWN, AND SHOULD BE ALIGNED WITH THE CORNER POSTS BOTTOM MOST HOLES.

3: USE 5/16" X 4-1/2" HEX BOLTS AND 5/16" WASHERS TO ATTACH THE TOP HOLES OF THE SANDBOX BOARD TO THE T-NUTS INSTALLED ON THE CORNER POSTS. THE SANDBOX BOARD BOTTOM HOLES WILL BE USED LATER.

4: LAY THE 2 X 6 X 47-1/2" ENTRANCE BOARD ON TOP OF THE CORNER POSTS (USE DIAGRAM BELLOW TO CORRECTLY MOUNT THE ENTRANCE BOARD) THE HOLES IN THE ENTRANCE BOARD ARE OFFSET DOWN. ALIGN THE TOP HOLES WITH THE CORNER POSTS CENTER HOLES AND USE 5/16" X 4-1/2" HEX BOLTS AND 5/16" WASHERS TO ATTACH TO THE T-NUTS INSTALLED IN THE CORNER POSTS.

5: LAY THE 2 X 4 X 47-1/2" MIDDLE PANEL BOARD ON TOP OF THE CORNER POSTS, THE HOLES IN THE TOP PANEL BOARD ARE OFFSET DOWN, AND SHOULD BE ALIGNED WITH THE HOLES OF THE CORNER POSTS LOCATED ABOVE THE ENTRANCE BOARD AS SHOWN BELOW. USE 5/16" X 4-1/2" HEX BOLTS AND 5/16" WASHERS TO ATTACH THE MIDDLE PANEL BOARD TO THE T-NUTS INSTALLED IN THE CORNER POSTS.

6: USE A CARPENTERS SQUARE TO SQUARE THE BOARDS TO THE POSTS.

7: ONCE THE FRAME IS SQUARE USE THE 5/16" X 3-1/2" LAG SCREWS AND 5/16" WASHERS TO KEEP THE FRAME FROM MOVING OUT OF SQUARE.

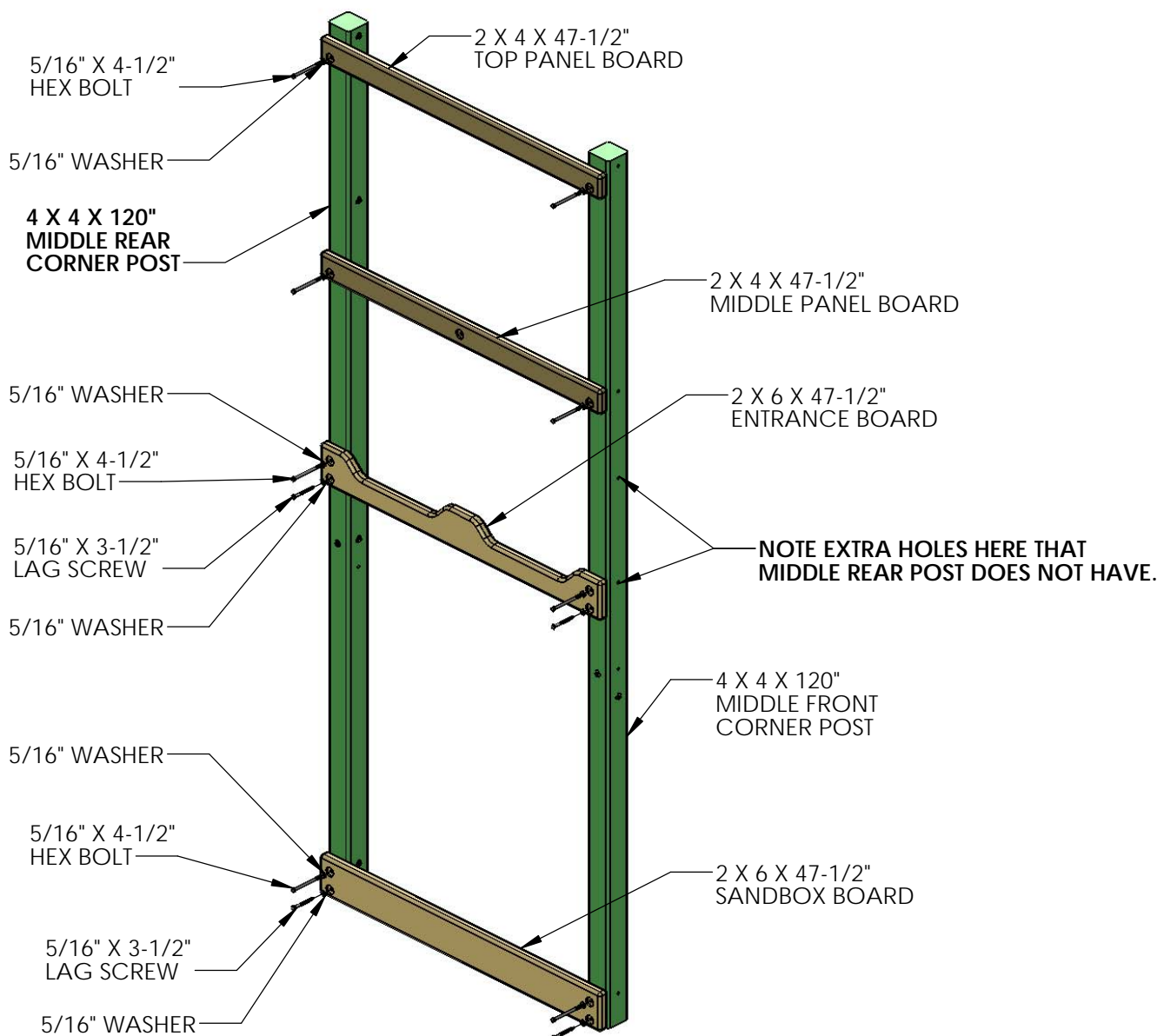

# STEP 5: CONNECTING PORCH AND MIDDLE FRAME

YOU WILL NEED AN EXTRA PERSON FOR THIS STEP.

1: WITH HELP, STAND UP THE PORCH FRAME AND THE MIDDLE FRAME ASSEMBLIES.

2: FASTEN THE 2 X 4 X 36-3/4" DECK SUPPORTS TO THE HOLES WITH 5/16" X 4-1/2" HEX BOLTS AND 5/16" WASHERS FROM THE INSIDE OF THE FORT.

3: FASTEN THE 2 X 6 X 80-3/4" SANDBOX BOARD FRONT AS SHOWN IN THE DIAGRAM BELOW, THE HOLES SHOULD BE OFFSET UP, INSTALL 5/16" X 4-1/2" HEX BOLTS THROUGH THE SANDBOX BOARD TOP HOLES IN TO THE CORNER POST HOLES LOCATED IN THE BOTTOM ENDS. MAKE SURE THE HEX BOLT GRABS THE T-NUT INSTALLED IN THE CORNER POST AND TIGHTEN. THE SAND BOX BOARD BOTTOM HOLES WILL BE USED LATTER.

REPEAT PREVIOUS SUB STEP FOR THE OPPOSITE SIDE OF THE FORT USING THE 2 X 6 X 80-3/4" SANDBOX BOARD REAR.

4: FASTEN THE 2 X 4 X 36-3/4" TOP PANEL BOARD OFFSET UP TO THE HOLES WITH 5/16" X 4-1/2" HEX BOLTS AND 5/16" WASHERS FROM THE OUTSIDE TOP OF THE FORT.

5: AT THIS POINT THE FRAME IS UNSTABLE, YOU MUST HAVE AN ASSISTANT HELP YOU MOVE THE FRAME TO AVOID RACKING THE FRAME AND POTENTIALLY CRACKING BOARDS.

6: PLACE THE FRAME IN ITS FINAL POSITION AND FOLLOW THE PROCEDURES AT THE FRONT OF THE MANUAL TO LEVEL AND SQUARE THE STRUCTURE. ONCE THE FRAME IS LEVEL, SQUARE, AND SET INTO POSITION; GO BACK AND INSERT THE 5/16" X 3-1/2" LAG SCREWS AND 5/16" WASHERS IN ALL OF THE REMAINING HOLES OF THE 2 X 6 PARTS. NOTE: THERE WILL NOT BE ANY PREDRILLED HOLES IN THE CORNER POSTS FOR LAG SCREWS.

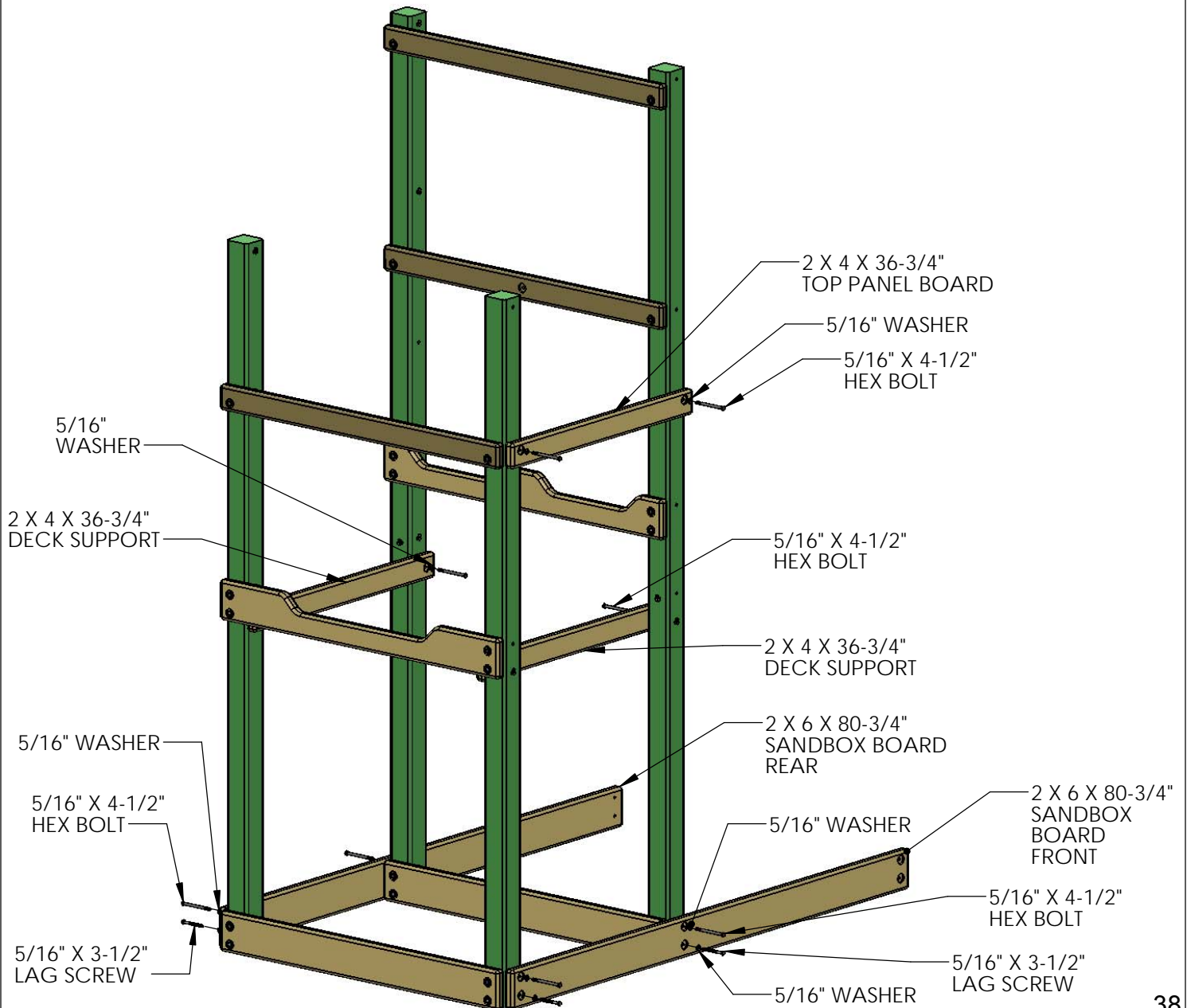



## STEP 6: INSTALLING THE ROCK WALL ENTRANCE BOARD

1: PLACE THE 2 X 6 X 36-3/4" ROCK WALL ENTRANCE BOARD ON THE FRONT OF THE CORNER POSTS. THE HOLES IN THE ROCK WALL ENTRANCE BOARD ARE OFFSET UP.

2: USE 5/16" X 4-1/2" HEX BOLTS AND 5/16" WASHERS TO ATTACH THE TOP HOLES OF THE ROCK WALL ENTRANCE BOARD THROUGH THE HOLES OF THE CORNER POST TO THE T-NUTS INSTALLED IN THE CORNER POSTS.

3: MAKE SURE THE STRUCTURE IS IN THE DESIRED POSITION, LEVEL AND SQUARE SIDE TO SIDE. PROCEED TO INSERT THE 5/16" X 3-1/2" LAG SCREWS AND 5/16" WASHERS IN THE ROCK WALL ENTRANCE BOARD BOTTOM HOLES. NOTE: THERE WILL NOT ANY PRE DRILLED HOLES IN THE CORNER POSTS FOR THE LAG SCREWS.

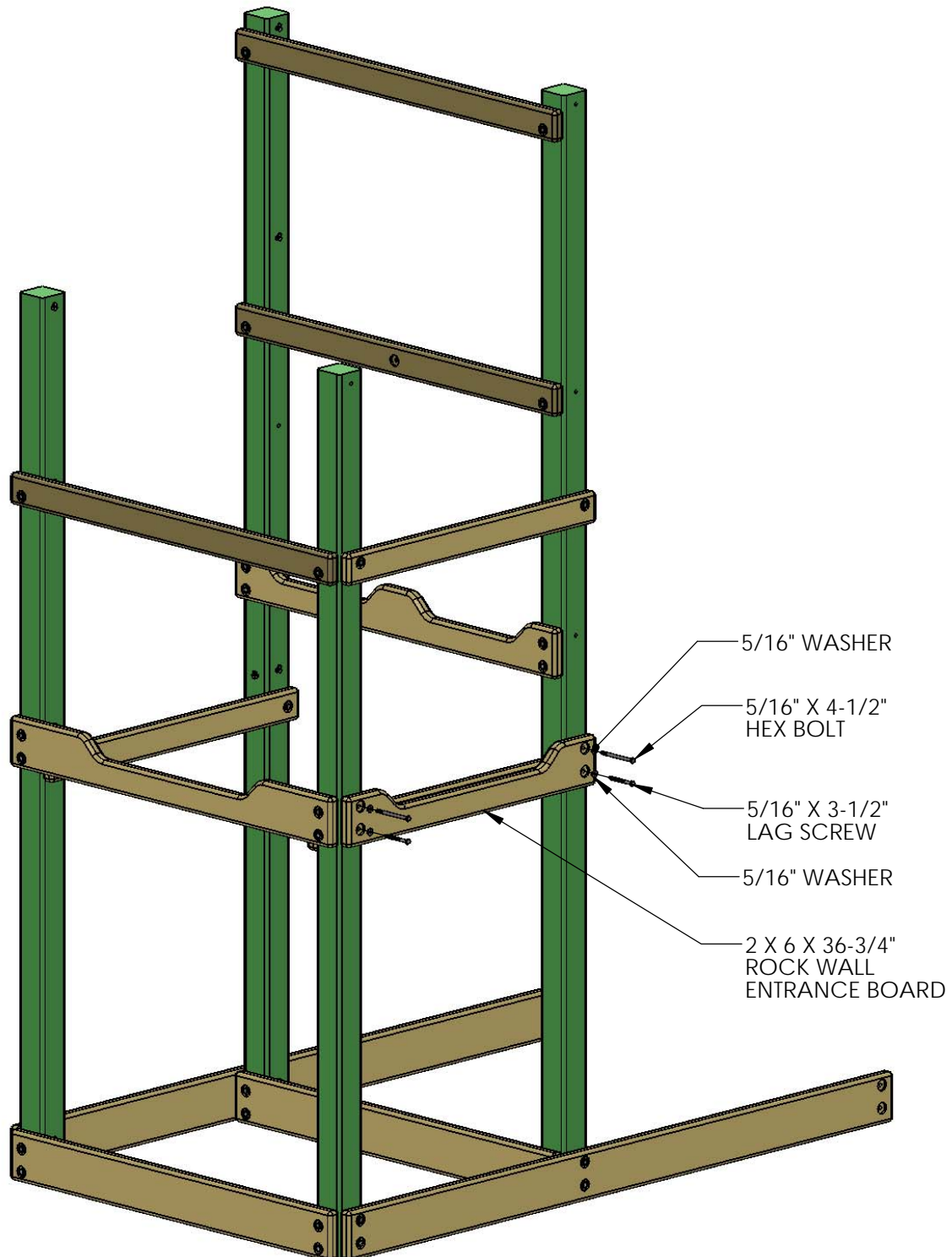

## STEP 7: INSTALLING BOTTOM PANEL BOARDS

1: PLACE THE 2 X 6 X 47-1/2" BOTTOM PANEL BOARD (THIS BOARD IS ALSO CALLED SANDBOX BOARD) AGAINST THE MIDDLE FRAME CORNER POSTS AS SHOWN IN THE DIAGRAM BELOW, HOLES ARE OFFSET DOWN.

2: USE 5/16" X 4-1/2" HEX BOLTS AND 5/16" WASHERS TO ATTACH THE TOP HOLES OF THE BOTTOM PANEL BOARD TO THE T-NUTS INSTALLED ON THE CORNER POSTS. MAKE SURE THE STRUCTURE IS LEVEL AND SQUARE; INSERT THE 5/16" X 3-1/2" LAG SCREWS AND 5/16" WASHERS IN TO THE BOTTOM HOLES OF THE BOTTOM PANEL BOARD.

3: PLACE THE 2 X 6 X 36-3/4" BOTTOM PANEL BOARD AGAINST THE CORNER POSTS AT THE REAR AS SHOWN IN THE DIAGRAM BELOW, HOLES ARE OFFSET UP.

4: USE 5/16" X 4-1/2" HEX BOLTS AND 5/16" WASHERS TO ATTACH THE TOP HOLES OF THE BOTTOM PANEL BOARD TO THE T-NUTS INSTALLED ON THE CORNER POSTS. MAKE SURE THE STRUCTURE IS LEVEL AND SQUARE; INSERT THE 5/16" X 3-1/2" LAG SCREWS AND 5/16" WASHERS INTO THE BOTTOM HOLES OF THE BOTTOM PANEL BOARD.

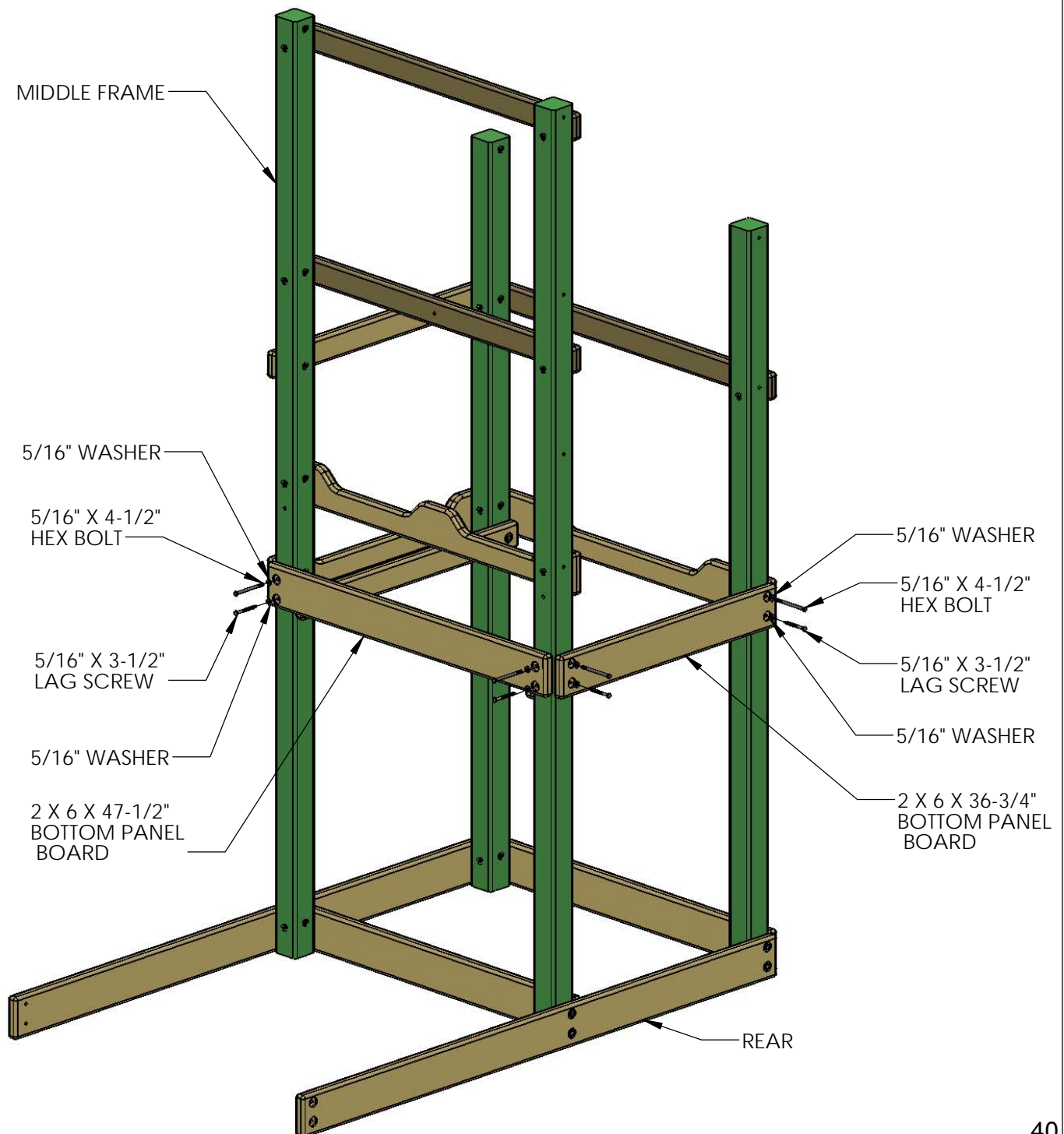

## STEP 8: ATTACHING T-NUTS TO THE END FRAME CORNER POSTS

- 1: THIS STEP IS CRITICAL TO BUILDING THE FORT PROPERLY. IF ANY MISTAKES ARE MADE HERE, YOU WILL NEED TO DIS-ASSEMBLE AND THEN RE-ASSEMBLE TO MAKE YOUR CORRECTIONS.
- 2: MAKE SURE HOLES ARE FREE OF ANY OBSTRUCTIONS. USE A BOLT TO CLEAN OUT ANY DEBRIS.
- 3: LAY OUT EACH OF THE 4 X 4 X 120" END CORNER POSTS IN THE AREA YOU INTENDED ON BUILDING THE FORT SIDE OF THE PLAY SET.
- 4: USE THE DIAGRAM BELOW TO CORRECTLY IDENTIFY AND ORIENT THE NECESSARY DIRECTION THE POSTS SHOULD FACE.
- 5: USE A HAMMER TO SEAT THE T-NUTS AFTER INSERTING THEM INTO THE HOLES SHOWN IN THE DIAGRAM BELOW.
- 6: THE BARREL OF THE T-NUT SHOULD GO INTO THE HOLE FIRST. HAMMER THE T-NUT UNTIL IS FLUSH / ALMOST FLUSH TO THE CORNER POSTS.
- 7: PAY CLOSE ATTENTION TO THE CORNER POSTS, MAKE SURE YOU IDENTIFY THE END REAR CORNER POST AND THE END FRONT CORNER PORT. THE DIFFERENCE IS ONE OF THE HOLES IN THE END REAR IS PLACED HIGHER THAN THE HOLE IN THE END FRONT CORNER POST. SEE DIAGRAM NOTES BELOW.

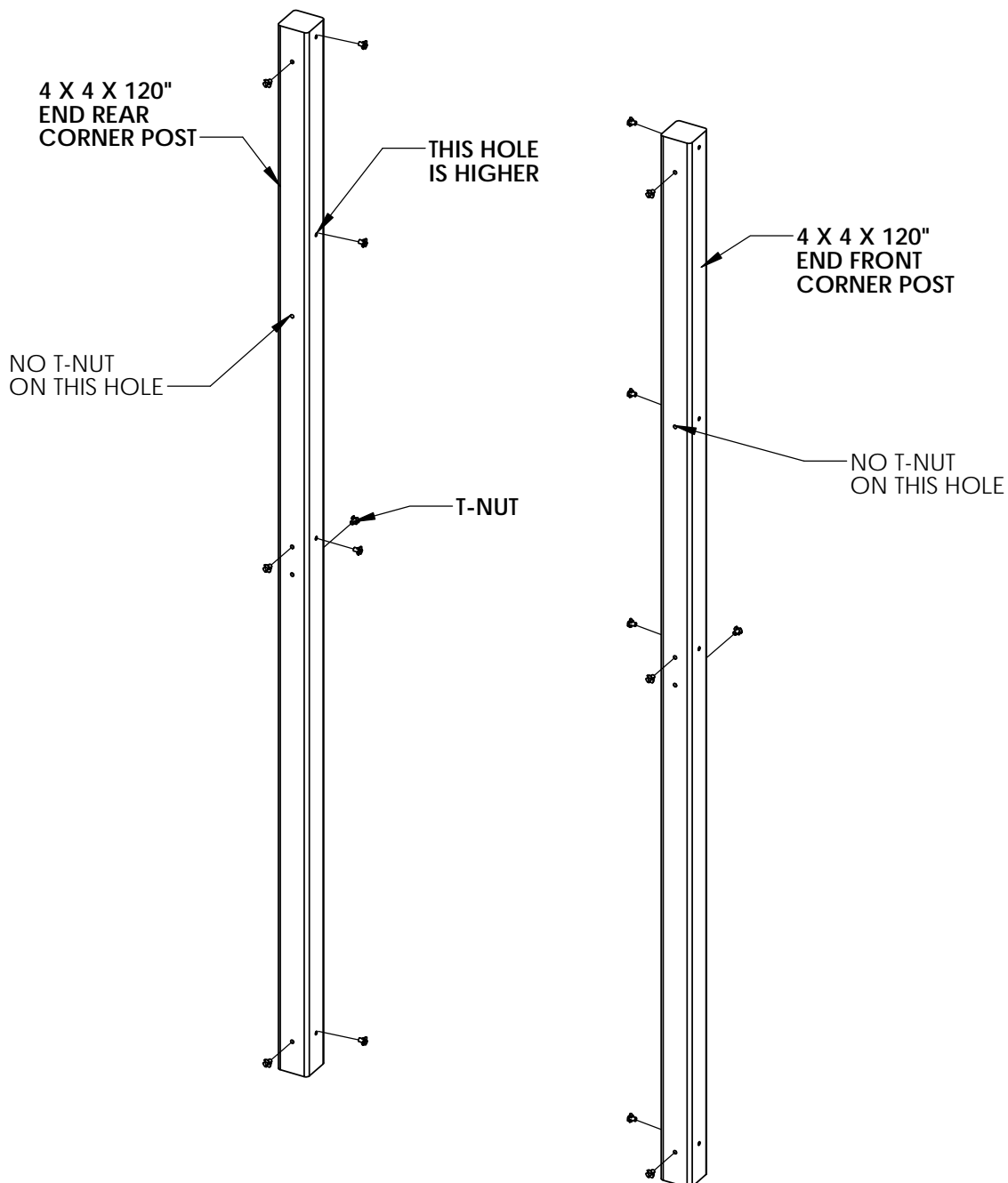

## STEP 9: ASSEMBLING THE END FRAME

- 1: LAY THE CORNER POSTS ON THE GROUND IN THEIR PROPER ORIENTATION (USE DIAGRAM BELOW TO CORRECTLY IDENTIFY AND ORIENT THE NECESSARY DIRECTION THE POSTS SHOULD FACE).
- 2: LAY THE 2 X 6 X 47-1/2" SANDBOX BOARD ON TOP OF THE CORNER POSTS, THE HOLES IN THE SANDBOX BOARD ARE OFFSET DOWN, AND SHOULD BE ALIGNED WITH THE CORNER POSTS BOTTOM MOST HOLES.
- 3: USE 5/16" X 4-1/2" HEX BOLTS AND 5/16" WASHERS TO ATTACH THE TOP HOLES OF THE SANDBOX BOARD TO THE T-NUTS INSTALLED ON THE CORNER POSTS. THE SANDBOX BOARD BOTTOM HOLES WILL BE USED LATER.
- 4: LAY THE 2 X 6 X 47-1/2" BOTTOM PANEL BOARD ON TOP OF THE CORNER POSTS (USE DIAGRAM BELOW TO CORRECTLY MOUNT THE BOTTOM PANEL BOARD) THE HOLES IN THE BOTTOM PANEL BOARD ARE OFFSET DOWN. ALIGN THE TOP HOLES WITH THE CORNER POSTS CENTER HOLES AND USE THE 5/16" X 4-1/2" HEX BOLTS TO ATTACH TO THE T-NUTS INSTALLED IN THE CORNER POSTS.
- 5: LAY THE 2 X 4 X 47-1/2" TOP PANEL BOARD ON TOP OF THE CORNER POSTS, THE HOLES IN THE TOP PANEL BOARD ARE OFFSET DOWN, AND SHOULD BE ALIGNED WITH THE TOP HOLES OF THE CORNER POSTS AS SHOWN BELOW. USE 5/16" X 4-1/2" HEX BOLTS TO ATTACH THE TOP PANEL BOARD TO THE T-NUTS INSTALLED IN THE CORNER POSTS.
- 6: USE A CARPENTERS SQUARE TO SQUARE THE BOARDS TO THE POSTS.

7: ONCE THE FRAME IS SQUARE USE THE 5/16" X 3-1/2" HEX LAG SCREWS AND 5/16" WASHERS TO KEEP THE FRAME FROM MOVING OUT OF SQUARE.

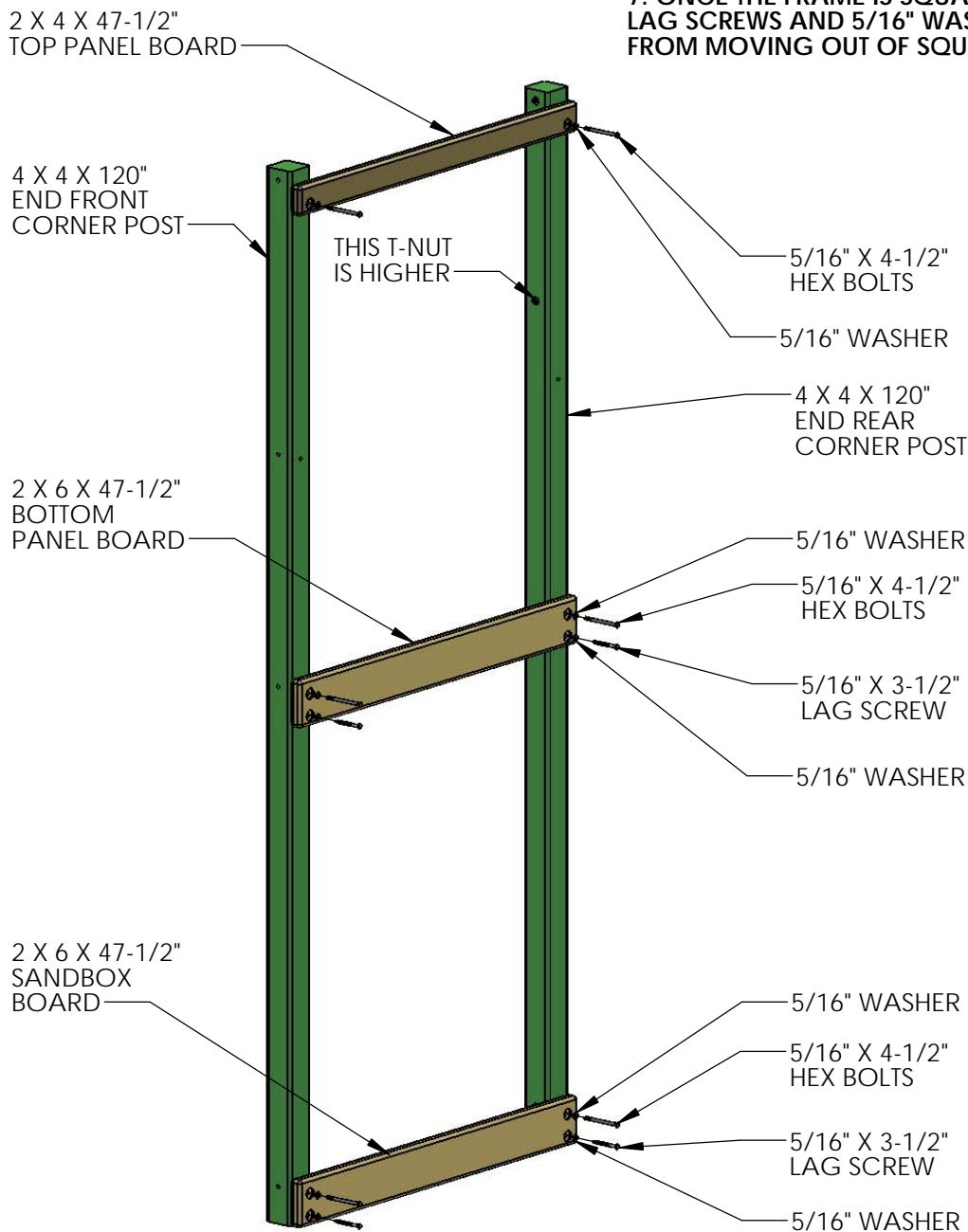

# STEP 10: CONNECTING THE END FRAME AND THE MIDDLE FRAME

YOU WILL NEED AN EXTRA PERSON FOR THIS STEP.

1: WITH HELP, STAND UP THE END FRAME ASSEMBLY.

2: FASTEN THE 2 X 6 X 80-3/4" SANDBOX BOARDS TO THE END FRAME CORNER POSTS AS SHOWN IN THE DIAGRAM BELOW, WITH 5/16" X 4-1/2" HEX BOLTS THROUGH THE SANDBOX BOARD TOP HOLES INTO THE CORNER POST. MAKE SURE THE HEX BOLT GRABS THE T-NUT INSTALLED IN THE CORNER POST AND TIGHTEN. THE SAND BOX BOARD BOTTOM HOLES WILL BE USED LATTER.

REPEAT PREVIOUS SUB STEP FOR THE OPPOSITE SIDE OF THE FORT.

3: FASTEN THE 2 X 4 X 47-1/2" TOP PANEL BOARD TO THE HOLES WITH 5/16" X 4-1/2" HEX BOLTS AND 5/16" WASHERS FROM THE OUTSIDE TOP OF THE FORT.

4: FASTEN THE 2 X 4 X 47-1/2" RADRIDE TOP PANEL BOARD TO THE HOLES ON THE OPPOSITE SIDE OF THE FORT WITH 5/16" X 4-1/2" HEX BOLTS AND 5/16" WASHERS. THE MIDDLE HOLE SHOULD BE 19.75" FROM THE POST AS SHOWN BELOW.

5: FASTEN THE 2 X 6 X 47-1/2" SLIDE EXIT BOARD TO THE HOLES ABOVE THE SANDBOX BOARD ON THE FRONT OUTSIDE OF THE FORT WITH 5/16" X 4-1/2" HEX BOLTS AND 5/16" WASHERS.

6: FOLLOW THE PROCEDURES AT THE FRONT OF THE MANUAL TO LEVEL AND SQUARE THE STRUCTURE. ONCE THE FRAME IS LEVEL, SQUARE, AND SET INTO POSITION; GO BACK AND INSERT THE 5/16" X 3-1/2" LAG SCREWS AND 5/16" WASHERS IN ALL OF THE REMAINING HOLES OF THE 2 X 6 PARTS. NOTE: THERE WILL NOT BE ANY PREDRILLED HOLES IN THE CORNER POSTS FOR LAG SCREWS.

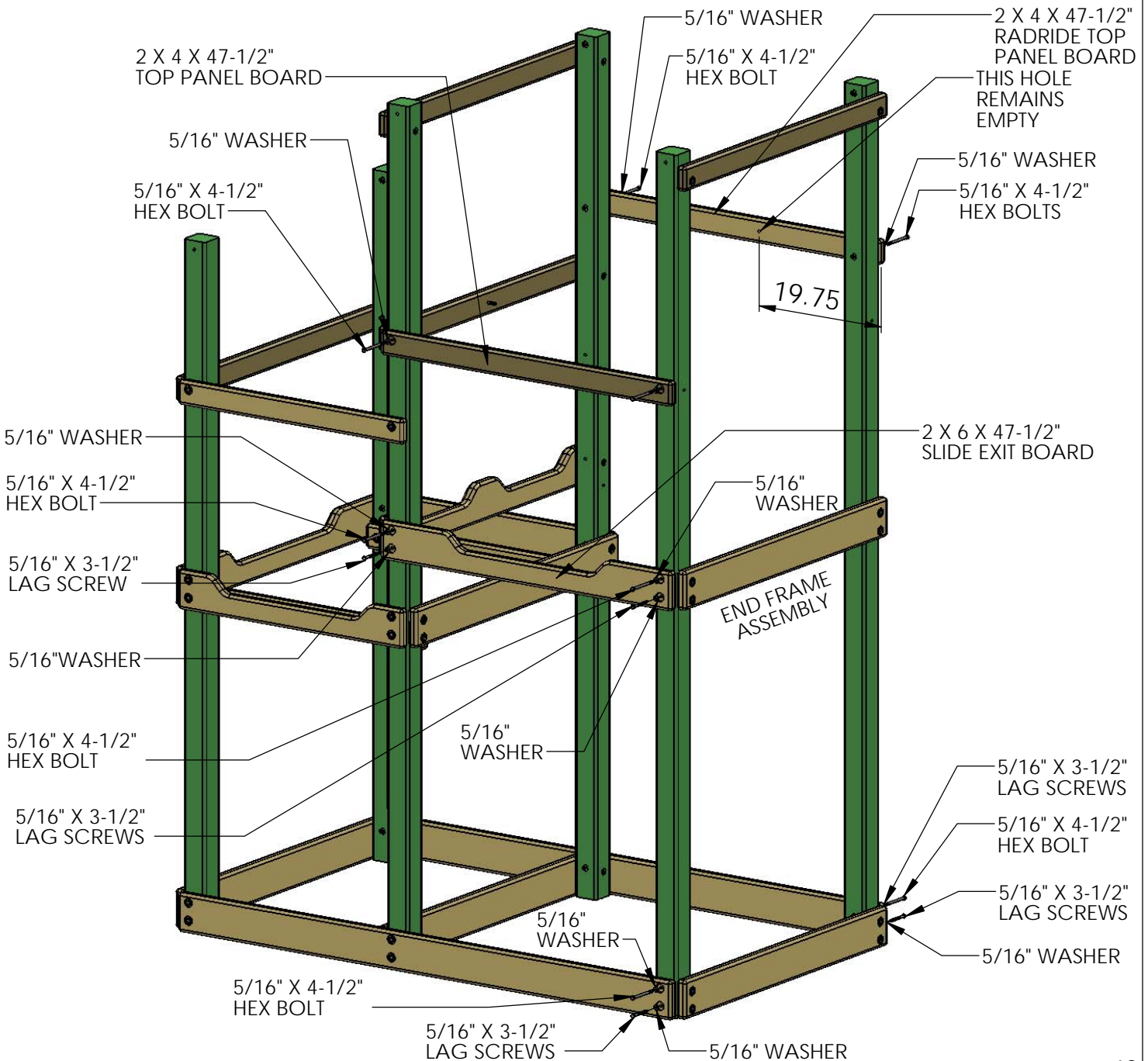

# STEP 11: SECOND LEVEL DECK SUPPORTS

1: FASTEN THE 2 X 4 X 47-1/2" DECK SUPPORTS TO THE POSTS WITH 5/16" X 4-1/2" HEX BOLTS AND 5/16" WASHERS FROM THE INSIDE OF THE FORT.

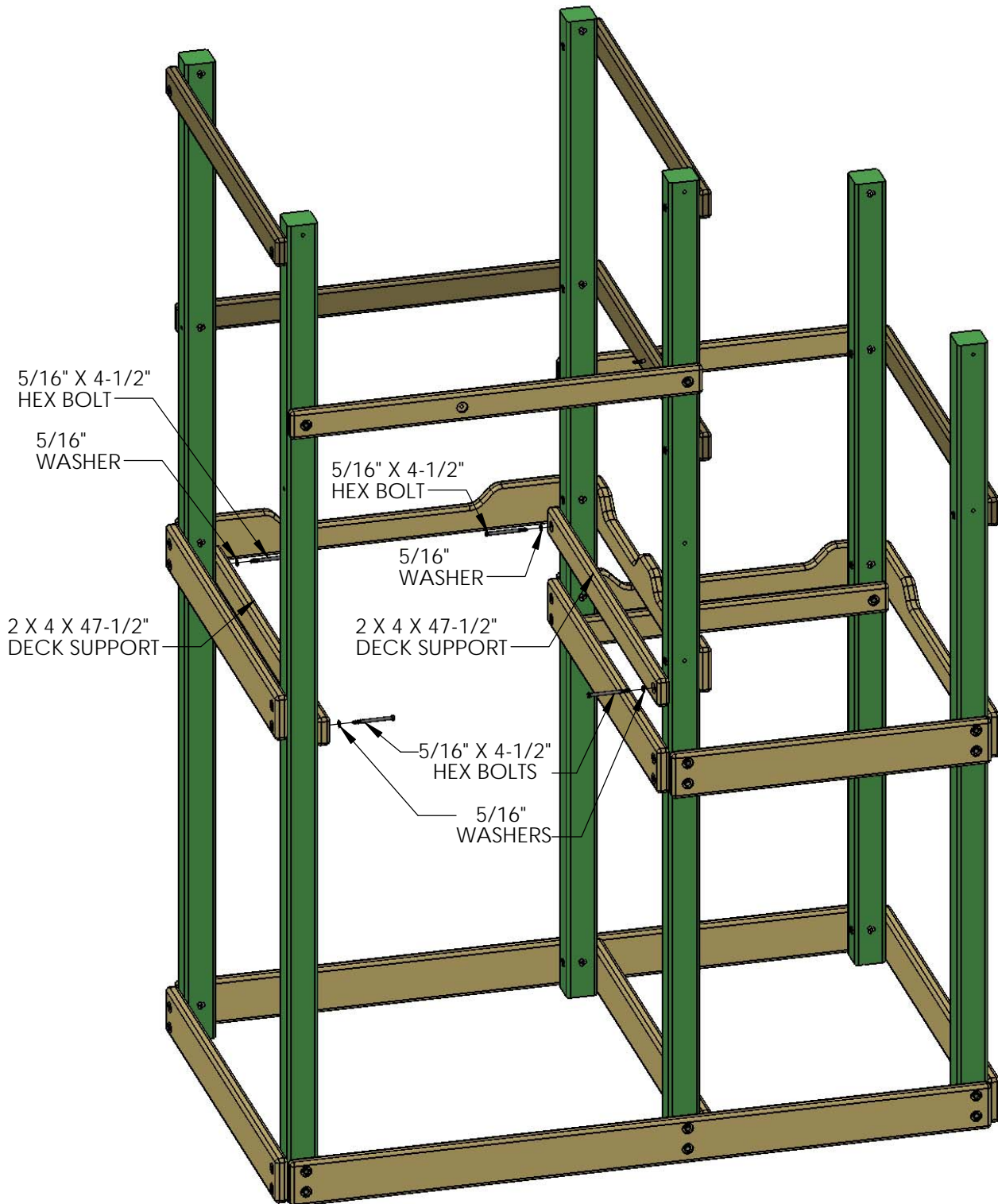



# STEP 12: ANGLE SUPPORTS

1: THE 2 X 4 X 13" ANGLE SUPPORTS ARE MOUNTED UNDERNEATH THE AREA WHERE THE DECK WILL BE LOCATED ON THE FRONT AND BACK OF THE FORT.

2: USE 2-1/2" WOOD SCREWS AT THE TOP TO ATTACH THE ANGLE SUPPORTS.

3: AT THE BOTTOM OF EACH ANGLE SUPPORT USE A 3" WOOD SCREW THROUGH THE ANGLE SUPPORT TOP HOLE INTO THE CORNER POST, AS SHOWN IN THE DIAGRAM BELOW.

4: AT THE BOTTOM OF EACH ANGLE SUPPORT USE A 2" WOOD SCREW THROUGH THE ANGLE SUPPORT LOWER HOLE INTO THE CORNER POST, AS SHOWN IN THE DIAGRAM BELOW.

NOTE: THE TOP OF THE ANGLE SUPPORTS MUST BE LOWER THAN THE TOP OF THE DECK SUPPORTS OR THEY WILL INTERFERE WITH THE DECK BOARDS WHEN THEY ARE INSTALLED.

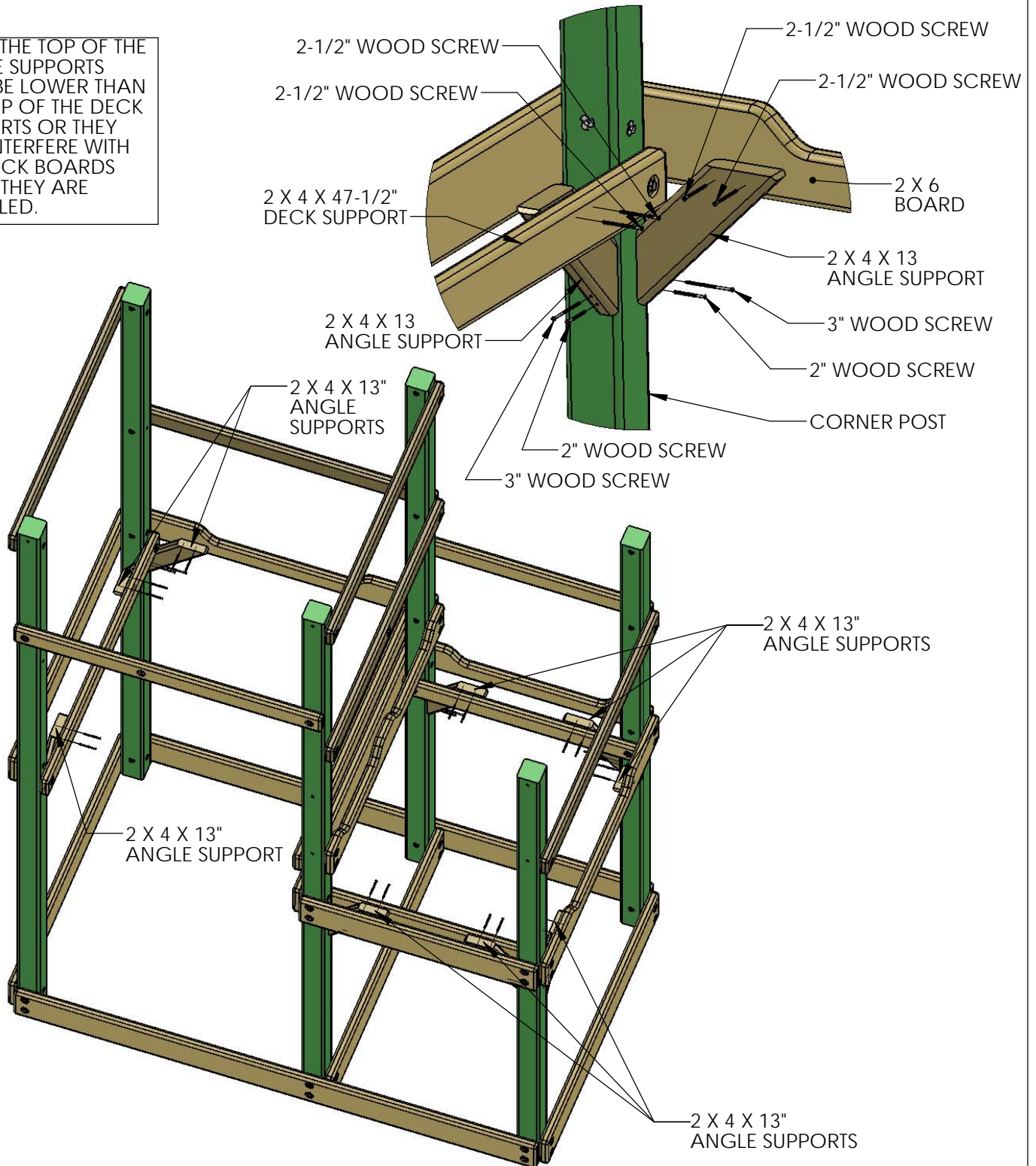

## STEP 13: PORCH DECK SPACERS

1: PLACE A 5/4 X 4 X 40-3/8" DECK SPACER AT ONE END OF THE FORT. CENTER THE BOARD BETWEEN THE CORNER POSTS AND ATTACH IT WITH 2" WOOD SCREWS THROUGH THE PREDRILLED HOLES AND INTO THE DECK SUPPORT BELOW. NOTE: THE TOP OF THE SCREW HEAD SHOULD BE FLUSH TO THE TOP OF THE DECK SPACER.

2: REPEAT PREVIOUS SUB-STEP FOR THE OPPOSITE END OF THE FORT.

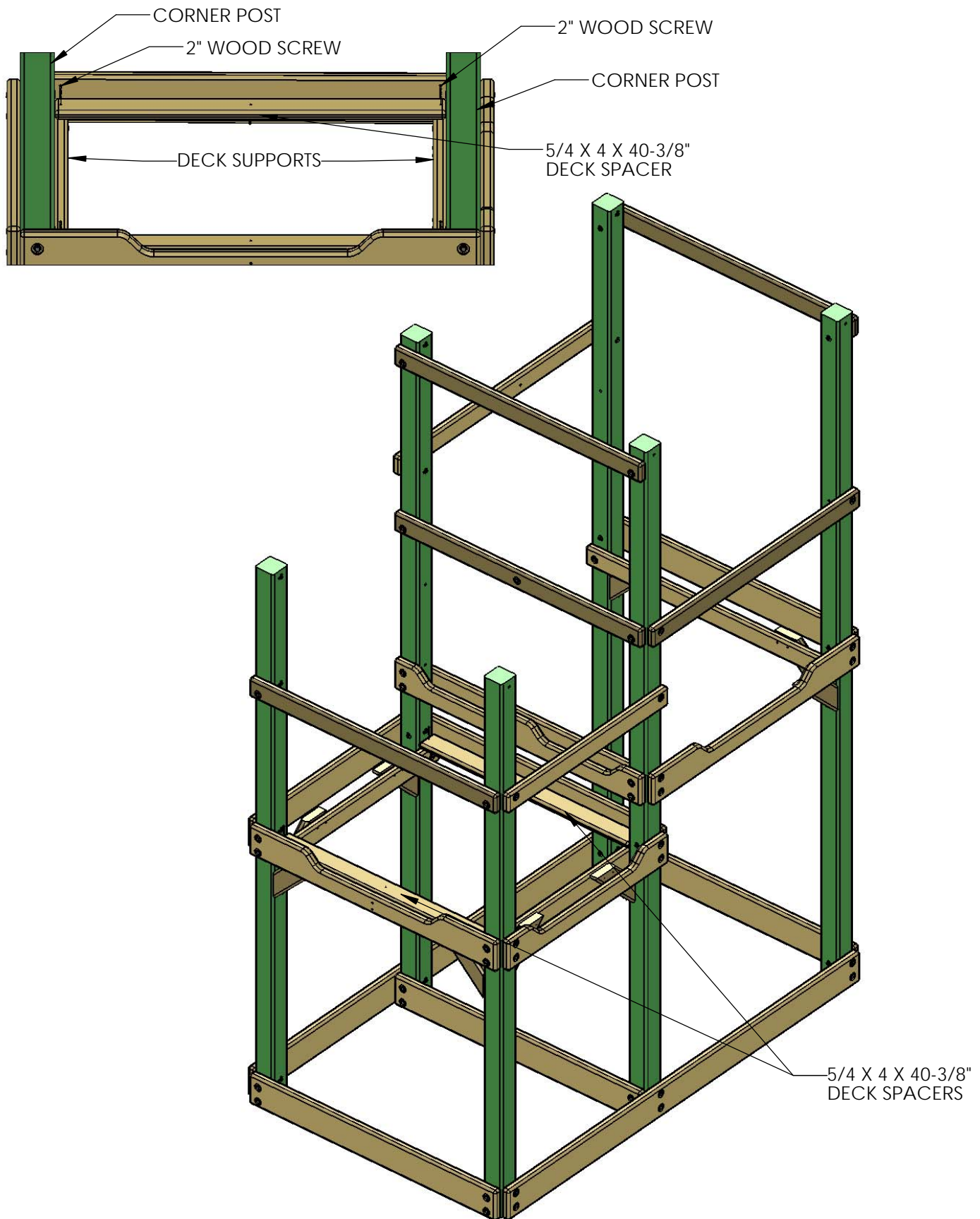



## STEP 14: PORCH CENTER DECK SUPPORT

1: PLACE THE 2 X 4 X 36-3/4" CENTER DECK SUPPORT UNDERNEATH THE CENTER OF THE DECK SPACERS. (USE THE HOLE AT THE CENTER OF THE DECK SPACER AS A GUIDE).

2: USE 2" WOOD SCREWS TO ATTACH THE DECK SPACERS TO THE CENTER DECK SUPPORT.

3: USE THE HOLE AT THE CENTER OF THE DECK SPACER AS A GUIDE TO MAKE A MARK ON THE OUTSIDE OF THE FORT TO REPRESENT A CENTER LINE. MAKE SURE THE 2 X 4 X 36-3/4" CENTER DECK SUPPORT IS LINED UP ON THESE MARKS.

4: INSTALL TWO 3" WOOD SCREWS INTO THE 2 X 4 X 36-3/4" CENTER DECK SUPPORT THROUGH THE OUTSIDE OF THE 2 X 6. REPEAT THIS SUBSTEP ON THE OPPOSITE END OF THE FORT.

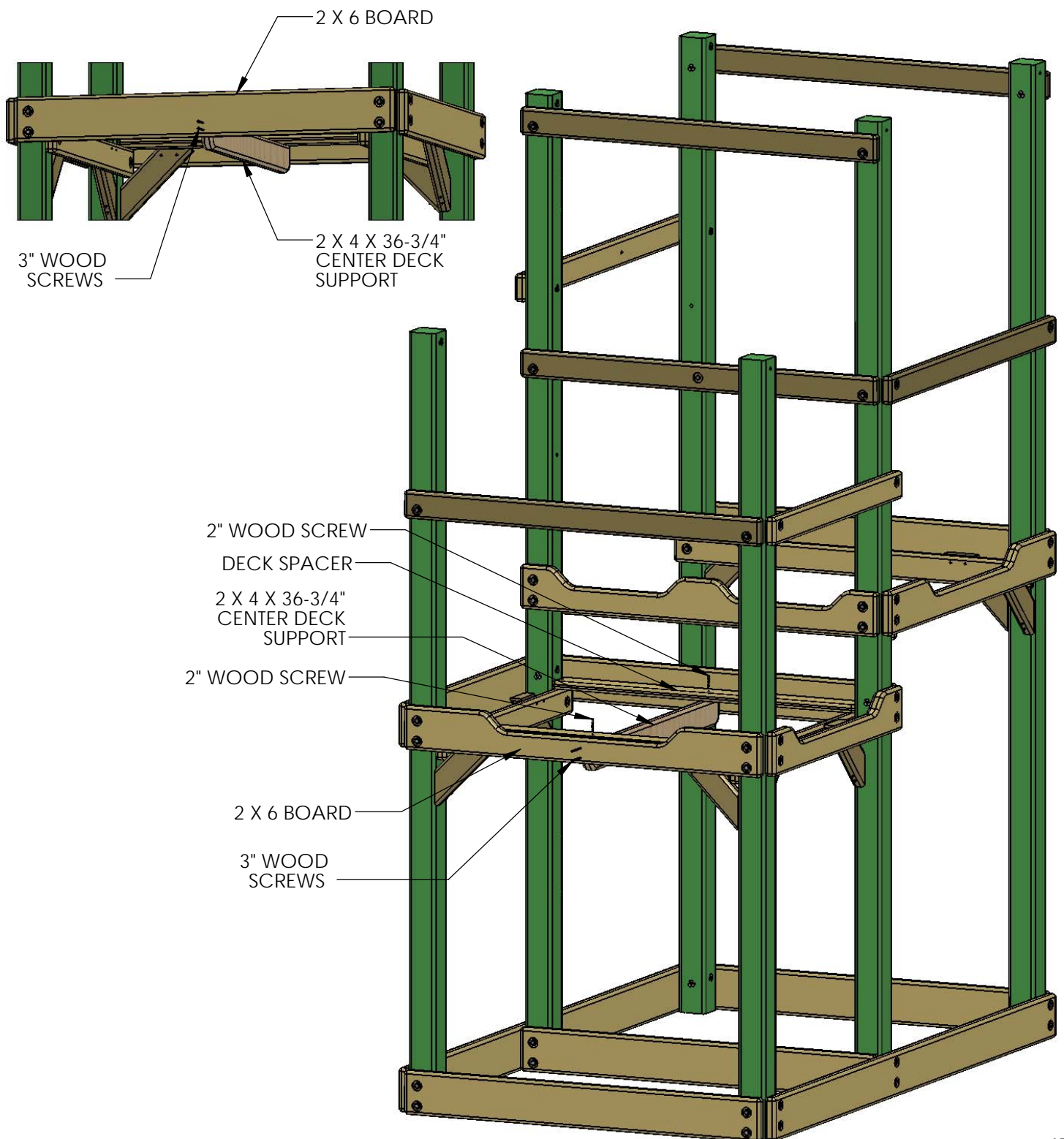

## STEP 15: PORCH DECK BOARDS

1: LAY ALL DECK BOARDS ACROSS THE DECK SUPPORTS BEFORE SECURING THEM TO THE FORT. THIS WILL ENSURE THAT YOU HAVE EQUAL SPACING ACROSS THE DECK.

2: START WITH A 5/4 X 6 X 47-3/8" DECK BOARD AT ONE END OF THE FORT. CENTER THE BOARD BETWEEN THE ROCK WALL ENTRANCE BOARD AND THE BOTTOM PANEL BOARD AND ATTACH IT WITH 2" WOOD SCREWS THROUGH THE PREDRILLED HOLES AND INTO THE DECK SUPPORTS BELOW. LEAVE A UNIFORM (APPROX. 1/4") SPACE BETWEEN THE DECK BOARDS. NOTE: THE TOP OF THE SCREW HEAD SHOULD BE FLUSH TO THE TOP OF THE DECK BOARDS.

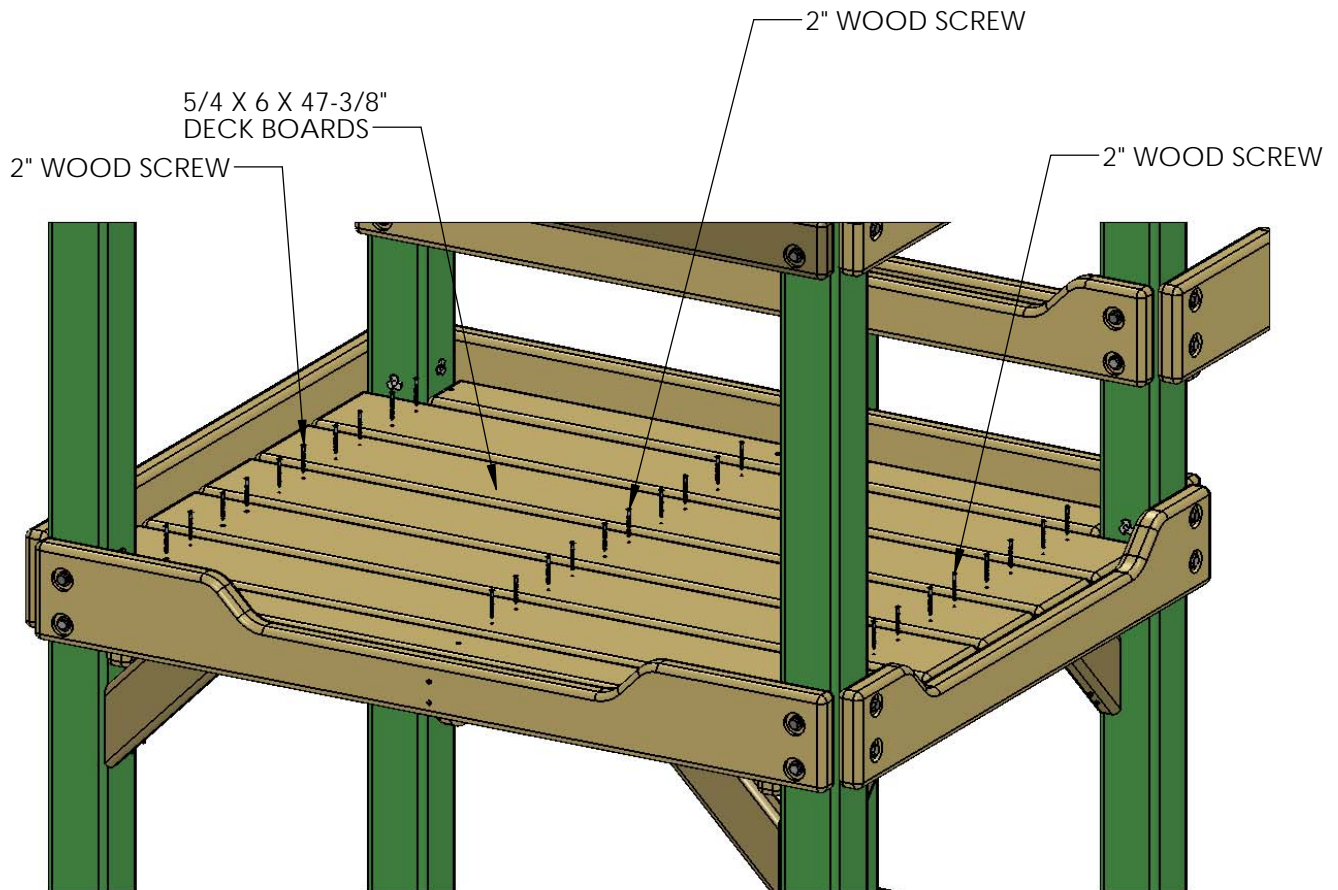
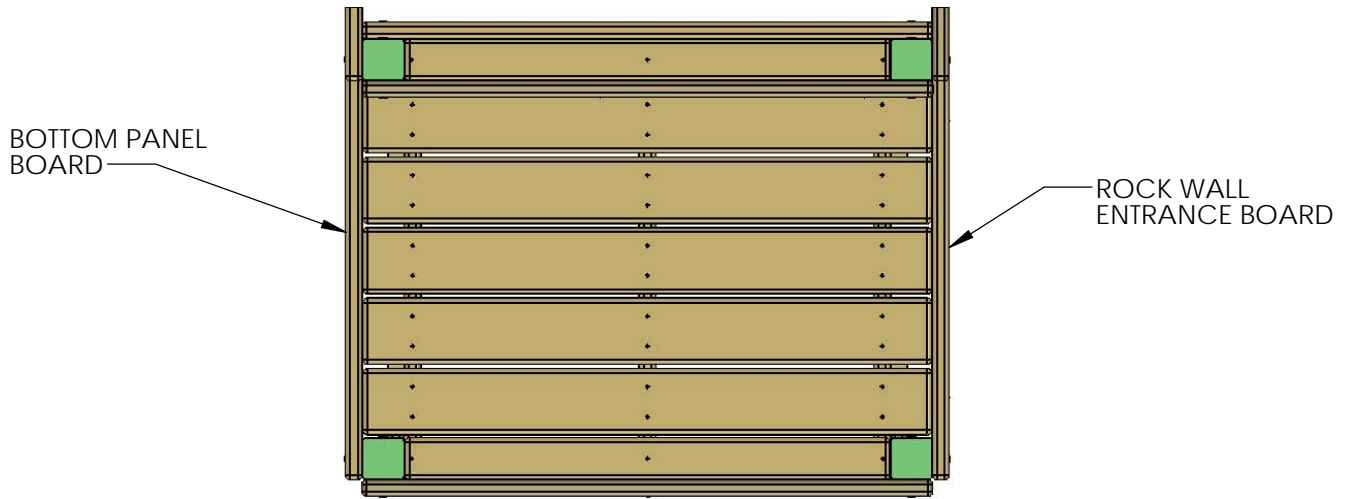

## STEP 16: SECOND LEVEL DECK SPACERS

1: PLACE THE 5/4 X 4 X 40-3/8" DECK SPACER AT ONE END OF THE FORT. CENTER THE BOARD BETWEEN THE CORNER POSTS AND ATTACH IT WITH 2" WOOD SCREWS THROUGH THE PREDRILLED HOLES AND INTO THE DECK SUPPORT BELOW. NOTE: THE TOP OF THE SCREW HEAD SHOULD BE FLUSH TO THE TOP OF THE DECK SPACER.

2: REPEAT PREVIOUS SUB-STEP FOR THE OPPOSITE END OF THE FORT.

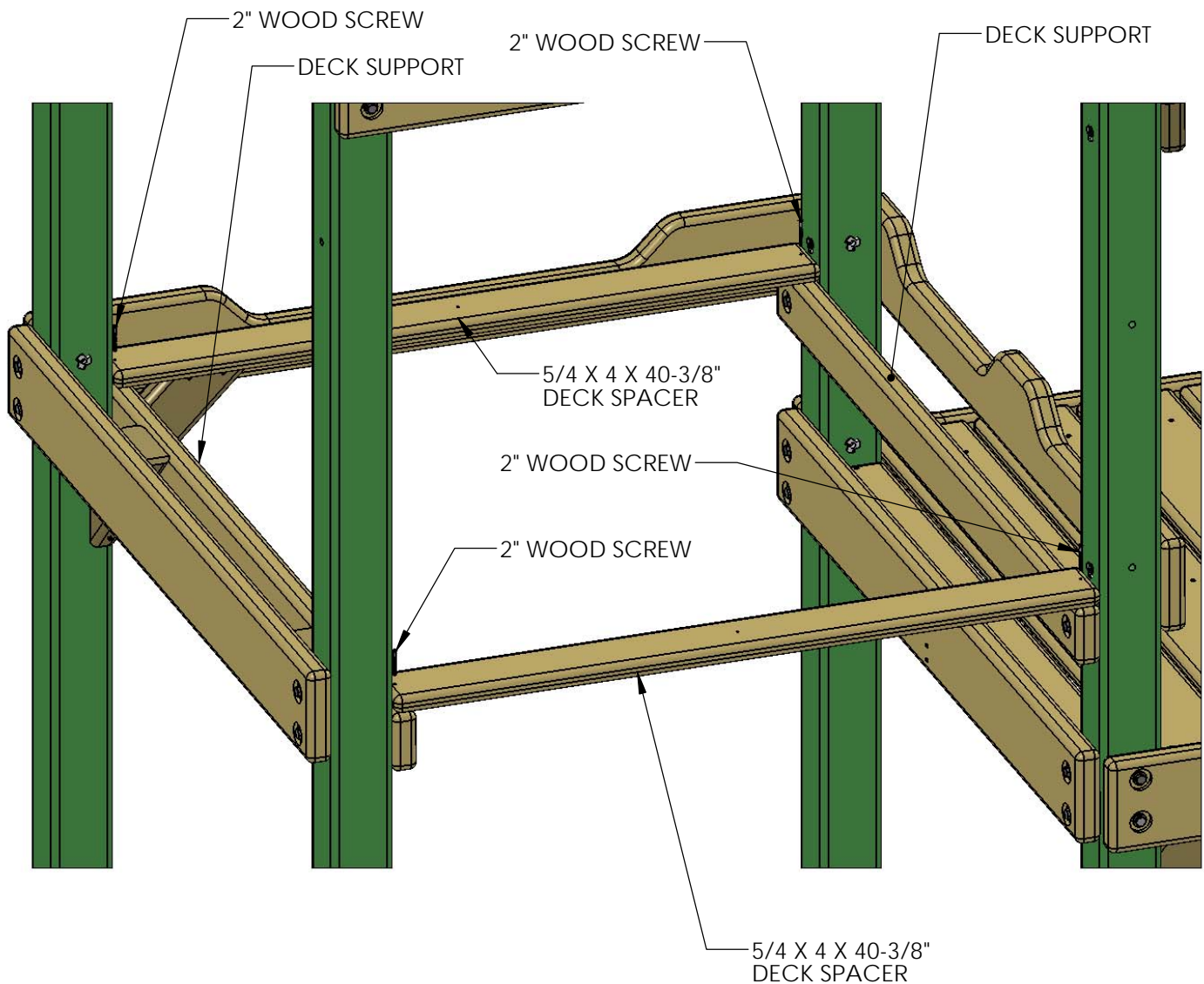



## STEP 17: SECOND LEVEL CENTER DECK SUPPORT

1: PLACE THE 2 X 4 X 47-1/2" CENTER DECK SUPPORT UNDERNEATH THE CENTER OF THE DECK SPACERS. (USE THE HOLE AT THE CENTER AS A GUIDE).

2: USE 2" WOOD SCREWS TO ATTACH THE DECK SPACERS TO THE CENTER DECK SUPPORT.

3: USE THE HOLE AT THE CENTER OF THE DECK SPACER AS A GUIDE TO MAKE A MARK ON THE OUTSIDE OF THE FORT TO REPRESENT A CENTER LINE. MAKE SURE THE 2 X 4 X 47-1/2" CENTER DECK SUPPORT IS LINED UP ON THESE MARKS.

4: INSTALL TWO 3" WOOD SCREWS INTO THE 2 X 4 X 47-1/2" CENTER DECK SUPPORT THROUGH THE OUTSIDE OF THE SLIDE EXIT BOARD.

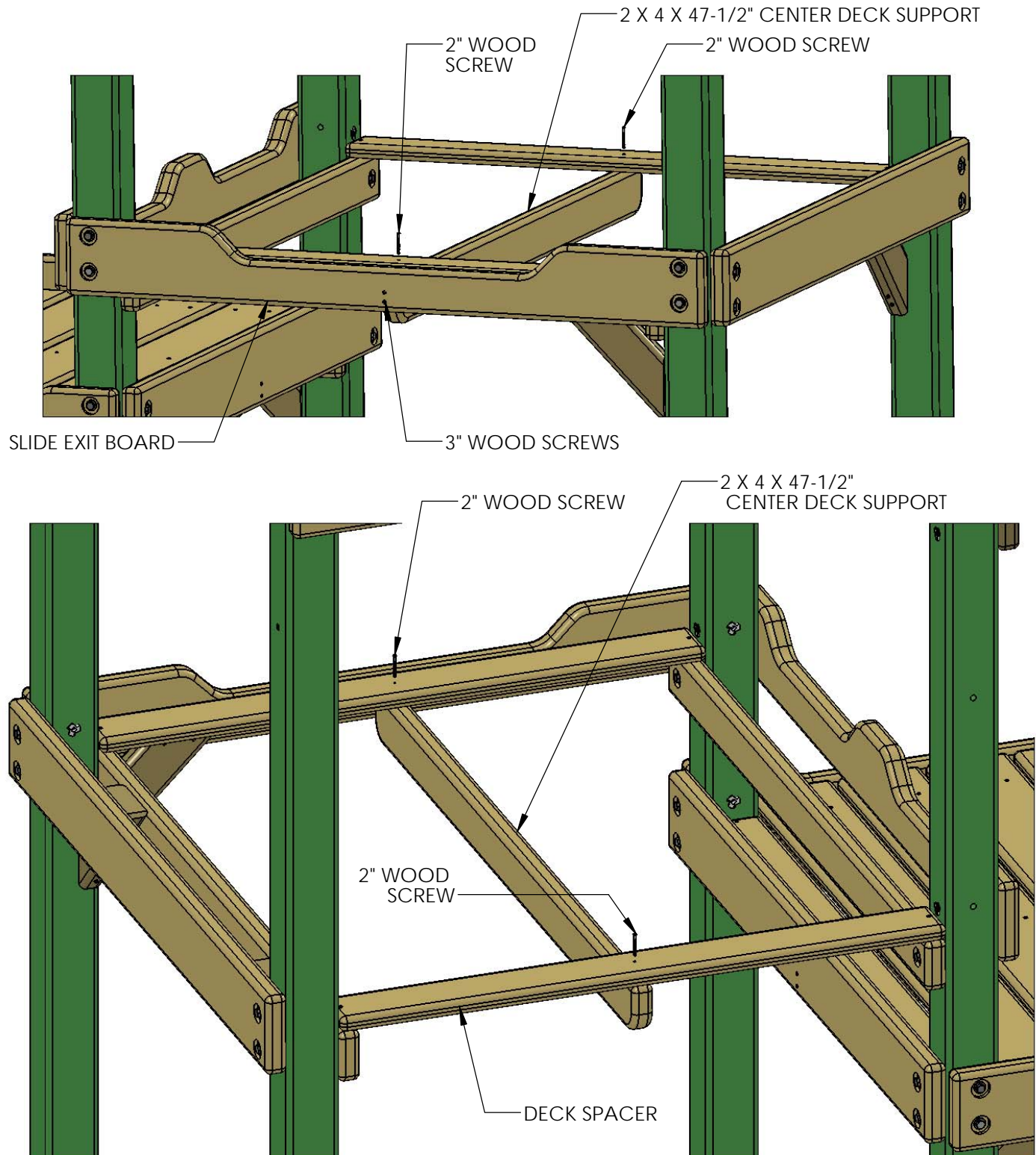

## STEP 18: SECOND LEVEL DECK BOARDS

1: LAY ALL DECK BOARDS ACROSS THE DECK SUPPORTS BEFORE SECURING THEM TO THE FORT. THIS WILL ENSURE THAT YOU HAVE EQUAL SPACING ACROSS THE DECK.

2: START WITH A 5/4 X 6 X 47-3/8" DECK BOARD AT ONE END OF THE FORT. CENTER THE BOARD BETWEEN THE ROCK ENTRANCE BOARD AND THE BOTTOM PANEL BOARD AND ATTACH IT WITH 2" WOOD SCREWS THROUGH THE PREDRILLED HOLES AND INTO THE DECK SUPPORTS BELOW. LEAVE A UNIFORM (APPROX. 1/4") SPACE BETWEEN THE DECK BOARDS. NOTE: THE TOP OF THE SCREW HEAD SHOULD BE FLUSH TO THE TOP OF THE DECK BOARDS.

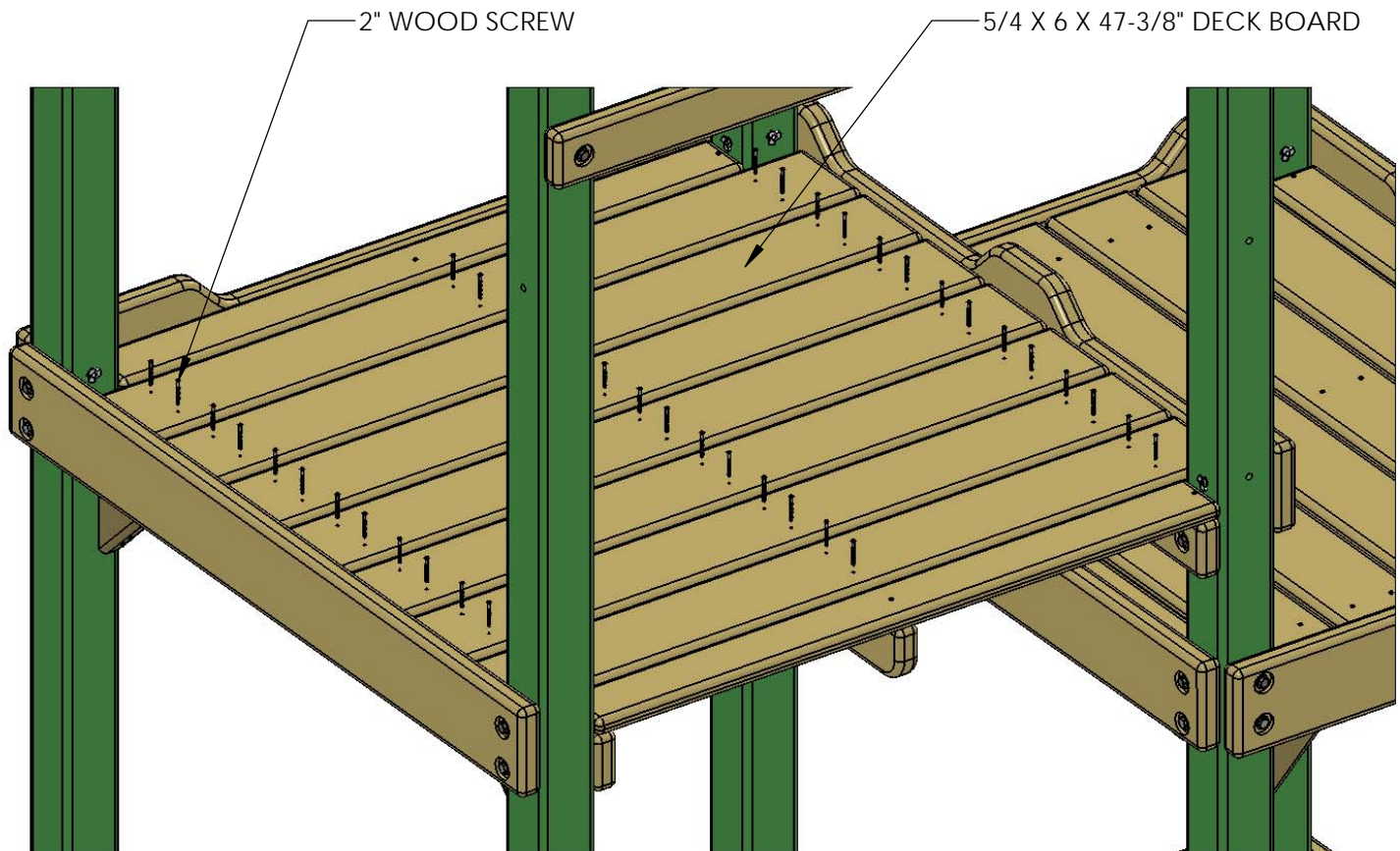
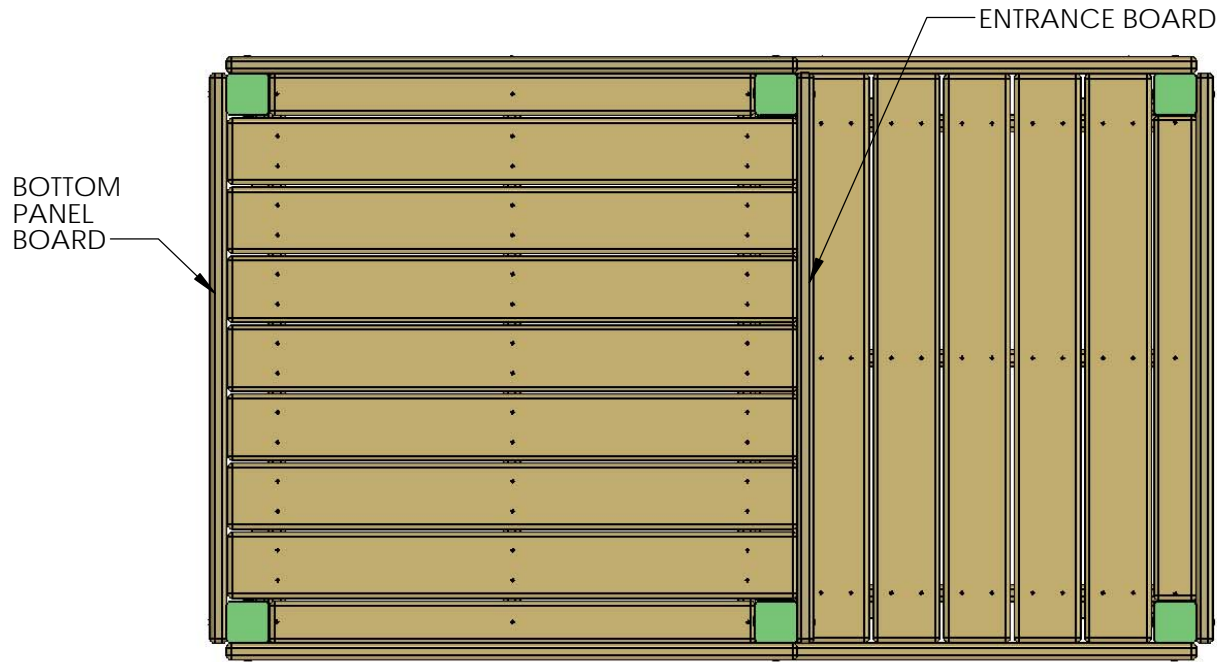

## STEP 19: LADDER

- 1: FIND TWO 2 X 4 X 57" LADDER SIDES.
- 2: POSITION THE LADDER SIDES (LEFT & RIGHT) SO THAT THE SLOTS IN THE BOARDS ARE FACING EACH OTHER AND ARE PARALLEL.
- 3: INSERT T-NUTS INTO THE INSIDE OF THE LADDER SIDES AND SET WITH A HAMMER.
- 4: FIND FOUR 2 X 4 X 17" LADDER STEPS.
- 5: PLACE THE STEPS INTO THE SLOTS ON THE LADDER SIDES. AND FASTEN WITH 2" WOOD SCREWS.
- 6: CAREFULLY TURN THE LADDER OVER AND PUT THE SCREWS INTO THE OTHER SIDE.
- 7: INSTALL THE 90° ANGLE BRACKETS ON THE OUTSIDE OF THE LADDER RAILS WITH 5/16 X 1-1/2" HEX BOLTS AND 5/16" WASHERS INTO THE 5/16" T-NUTS.
- 8: INSTALL THE 5/4 X 4 X 18-1/2" LADDER BACK ABOVE THE TOP STEP OF THE LADDER WITH TWO 2" WOOD SCREW PER SIDE.

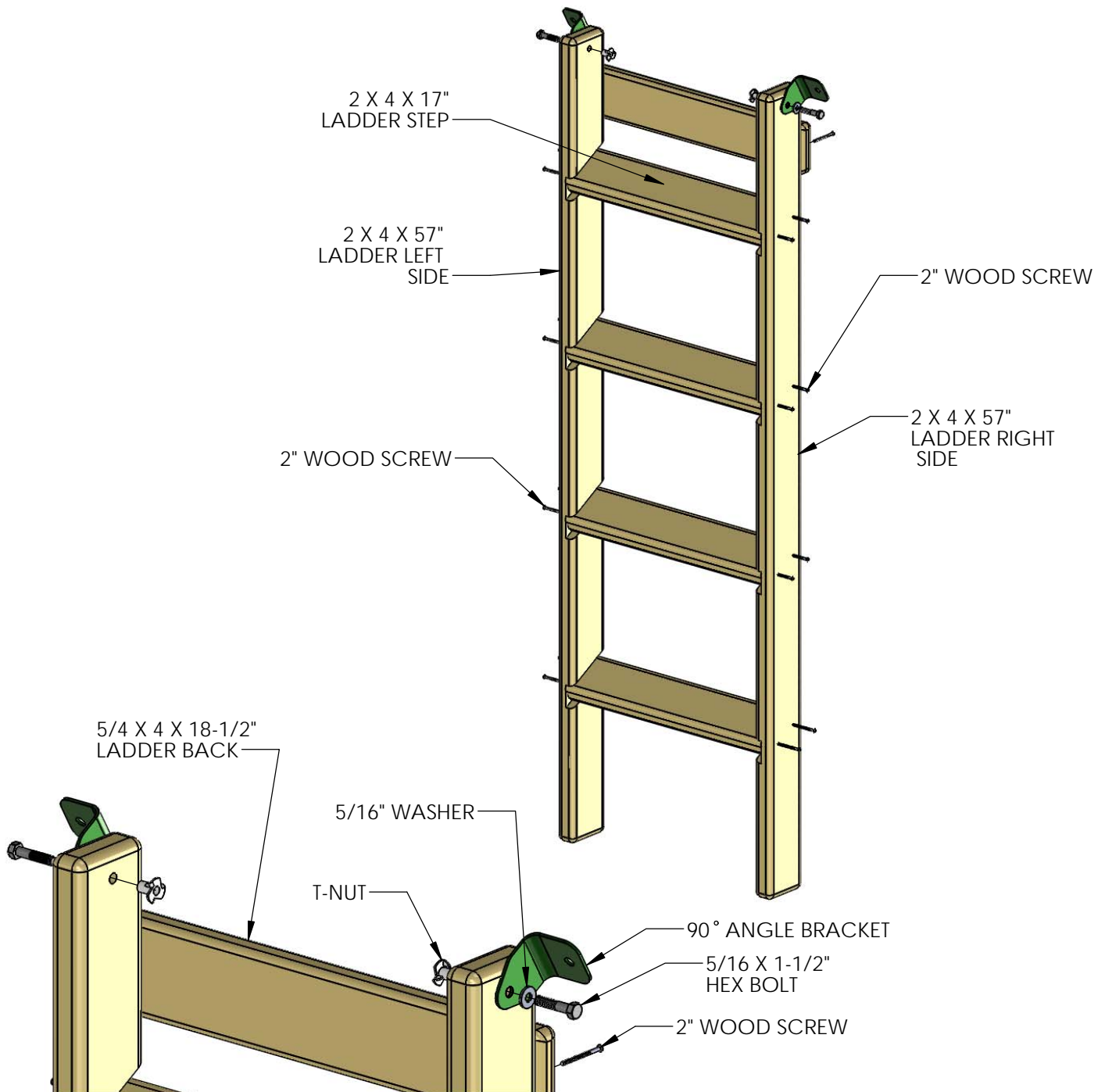

## STEP 20: LADDER TO FORT

1: PLACE THE LADDER INTO POSITION AS SHOWN IN THE DIAGRAM BELOW: THE SIDE OF THE LADDER SHOULD BE 14-1/2" FROM THE OUTSIDE OF THE CORNER POST. THE BOTTOM OF THE 90 DEGREE BRACKETS SHOULD BE 3/4" ABOVE THE BOTTOM OF THE ENTRANCE BOARD.

2: USING THE LADDER BRACKETS AS A TEMPLATE, DRILL A 3/8" HOLE THROUGH THE ENTRANCE BOARD.

3: FROM THE UNDERSIDE OF THE DECK INSERT A T-NUT INTO THE BACKSIDE OF THE 3/8" HOLES ON THE 2 X 6 ENTRANCE BOARD.

4: ATTACH THE LADDER WITH 5/16 X 1-1/2" HEX BOLTS AND 5/16" WASHERS.

5: WHEN THE BRACKETS ARE SECURE, AND THE LADDER IS IN ITS FINAL POSITION; TIGHTEN THE 5/16 X 1-1/2" BOLTS ON THE LADDER SIDES.

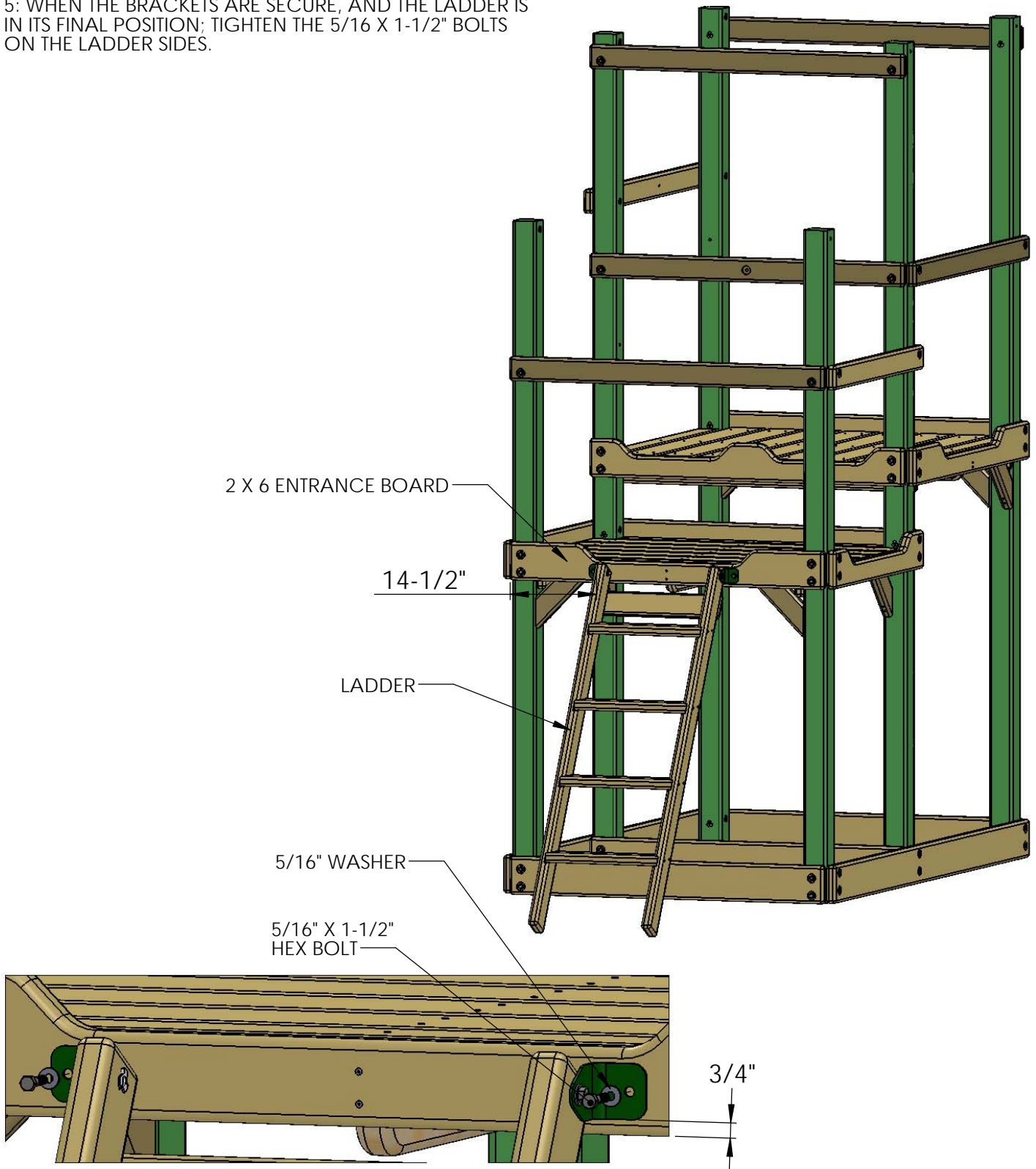



## STEP 21: ROCK WALL T-NUTS

1: FIND TWO 2 X 4 X 57" ROCK WALL SIDES.

2: POSITION THE ROCK WALL SIDES SO THAT THE HOLES IN THE BOARDS ARE BOTH FACING THE SAME WAY.

3: INSERT T-NUTS INTO THE INSIDE OF THE ROCK WALL SIDES AND SET WITH A HAMMER.

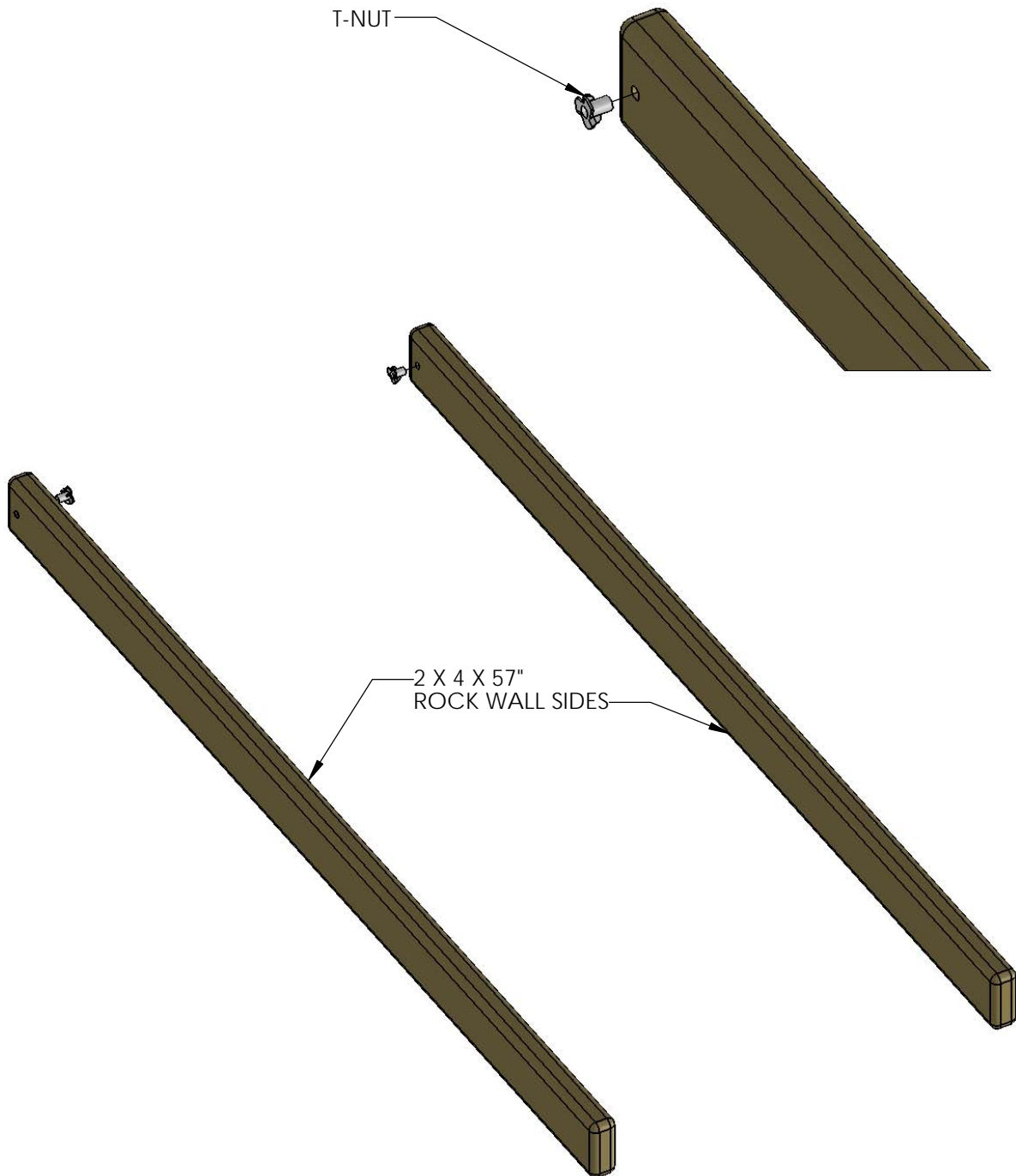



## STEP 22: ROCK WALL BOARDS

- 1: FIND THE 5/4 X 5 X 23-7/8" ROCK WALL BOARDS AND ONE 5/4 X 5 X 23-7/8" BOTTOM ROCK WALL BOARD ( WITH ONE HOLE ) AND ONE 5/4 X 3 X 23-7/8" ROCK WALL TOP CAP.
- 2: STARTING FROM THE TOP, PLACE ONE ROCK WALL BOARD ON TOP OF THE ROCK WALL SIDES, FLUSH TO THE TOP OF THE ROCK WALL SIDES, AND ATTACH WITH TWO 2" WOOD SCREWS ON EACH SIDE.
- 3: CONTINUE DOWN THE ROCK WALL WITH THE REMAINING ROCK WALL BOARDS. FASTENING EACH BOARD WITH TWO 2" WOOD SCREWS ON EACH END.
- 4: THE FINAL BOARD WILL BE THE BOTTOM ROCK WALL BOARD WITH ONE HOLE. ATTACH WITH TWO 2" WOOD SCREWS ON EACH SIDE.
- 5: ROCK WALL SIDES WILL NOT BE EVEN WITH THE BOTTOM ROCK WALL BOARD DUE TO MILLING AND WOOD VARIATIONS AND WOOD SHRINKAGE.
- 6: INSTALL THE 5/4 X 3 X 23-7/8" ROCK WALL TOP CAP BOARD AT THE TOP END OF THE ROCK WALL FLUSH TO THE INSIDE EDGE OF THE FIRST ROCK WALL BOARD INSTALLED AND FASTEN USING TWO 2" WOOD SCREWS PER SIDE.

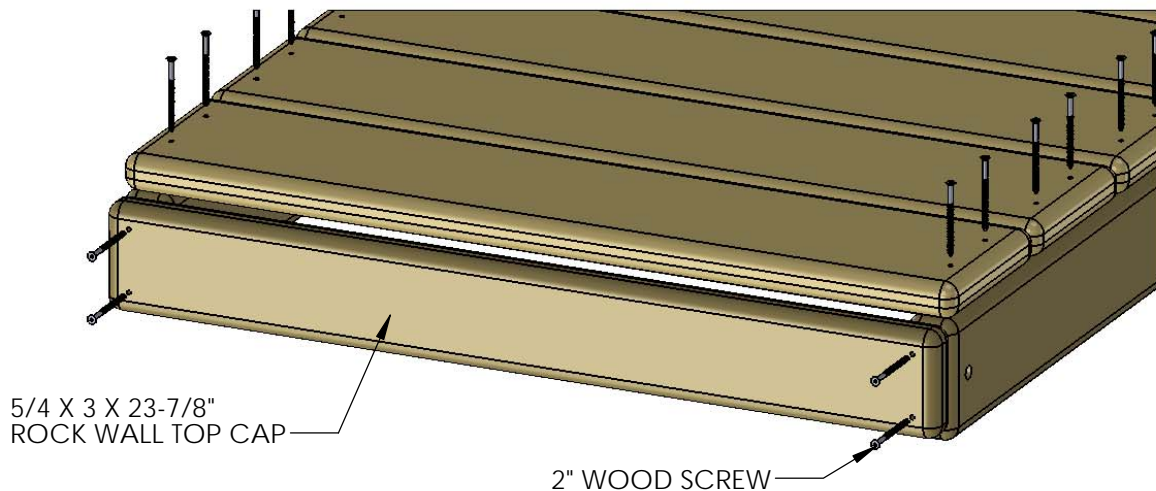
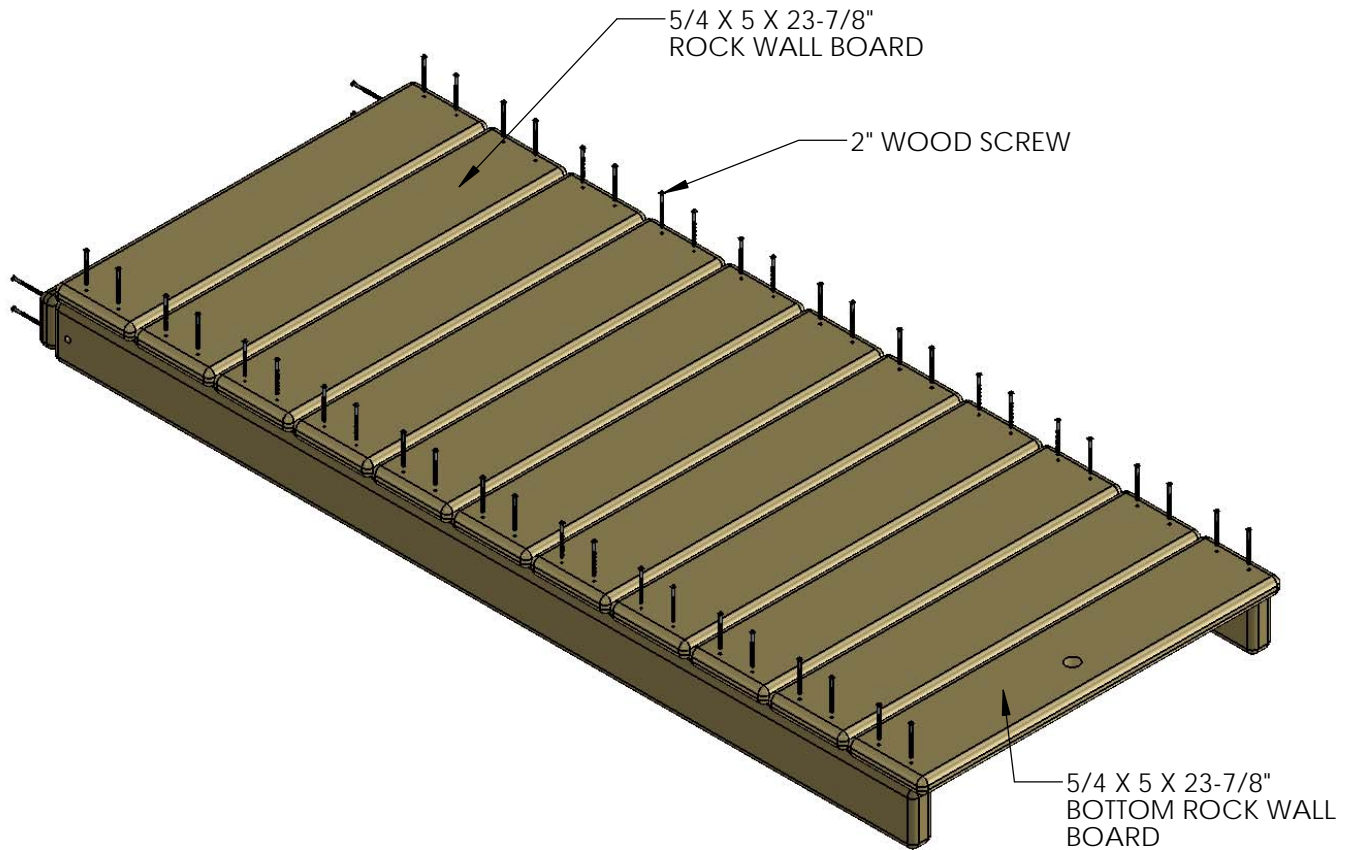

## STEP 23: ROCK WALL ROCKS

1: FIND TEN ROCKS AND THIRTY 1-1/4" PAN HEAD SCREWS AND THIRTY 1/4" WASHERS INCLUDED WITH THE ROCKS.

2: MOUNT THE ROCKS IN A STAGGERED MANNER ON THE ROCK WALL BOARDS. THREE PAN HEAD SCREWS WITH THREE WASHERS WILL SECURE EACH ROCK TO THE WALL.

NOTE: THE IMAGE SHOWN BELOW IS A GENERIC ARRANGEMENT OF ROCKS ON THE ROCK WALL. YOUR ACTUAL CONFIGURATION MAY BE DIFFERENT THAN WHAT YOU SEE BELLOW. ROCKS CAN BE ARRANGED IN ANY PATTERN AS LONG AS THEY WILL ALLOW PROPER ACCESS TO THE FORT. BE CREATIVE.

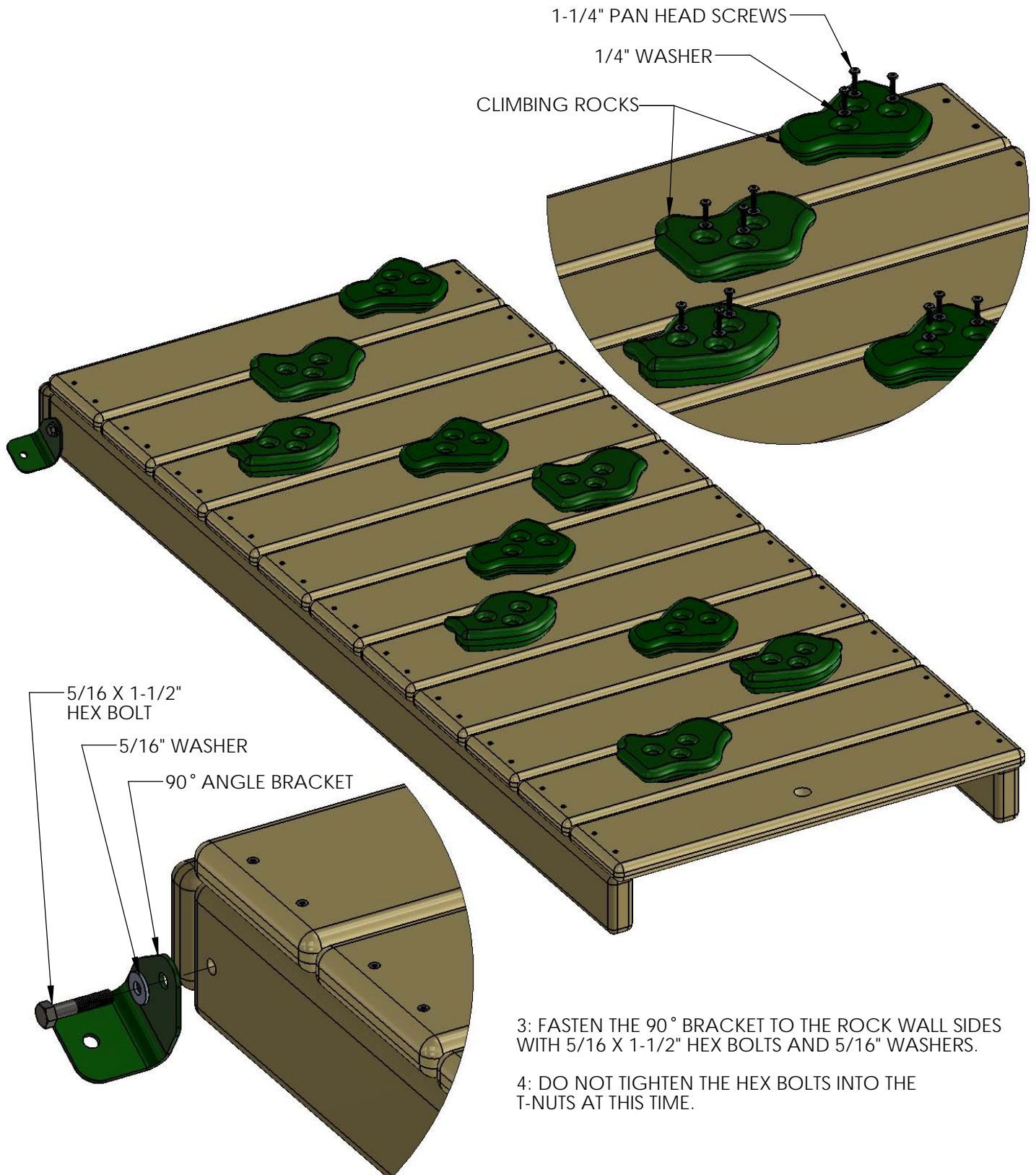

3: FASTEN THE 90° BRACKET TO THE ROCK WALL SIDES WITH 5/16 X 1-1/2" HEX BOLTS AND 5/16" WASHERS.

4: DO NOT TIGHTEN THE HEX BOLTS INTO THE T-NUTS AT THIS TIME.

## STEP 24: ROCK WALL TO FORT

1: PLACE THE ROCK WALL INTO POSITION AS SHOWN IN THE DIAGRAM BELOW: THE SIDE OF THE ROCK WALL SHOULD BE 6-1/2" FROM THE OUTSIDE OF THE CORNER POST. THE BOTTOM OF THE 90 DEGREE BRACKETS SHOULD BE 3/4" ABOVE THE BOTTOM OF THE ROCK WALL ENTRANCE BOARD.

2: USING THE ROCK WALL BRACKETS AS A TEMPLATE. DRILL A 3/8" HOLE THROUGH THE ROCK WALL ENTRANCE BOARD.

3: FROM THE UNDERSIDE OF THE DECK INSERT A T-NUT INTO THE BACKSIDE OF THE 3/8" HOLES ON THE 2 X 6 ENTRANCE BOARD.

4: ATTACH THE ROCK WALL WITH 5/16 X 1-1/2" HEX BOLTS AND 5/16" WASHERS.

5: WHEN THE BRACKETS ARE SECURE, AND THE ROCK WALL IS IN ITS FINAL POSITION; TIGHTEN THE 5/16 X 1-1/2" BOLTS ON THE ROCK WALL SIDES.





## STEP 25: SWING BEAM MOUNT AND SWING BEAM PLATE

1: FIND TWO TORQUE WASHERS. PLACE A 3/8" X 6-1/2" CARRIAGE BOLT INSIDE THE TORQUE WASHER MAKING SURE THAT THE TEETH ARE FACING IN THE SAME DIRECTION AS THE THREADS OF THE CARRIAGE BOLT. PLACE THE TORQUE WASHER / CARRIAGE BOLT ASSEMBLY INTO THE HOLES OF THE CORNER POSTS SO THAT THE HEAD OF THE CARRIAGE BOLT FACES THE INSIDE OF THE FORT. USE A HAMMER TO SET THE TORQUE WASHER INTO THE CORNER POST.

2: MOUNT THE 4 X 4 X 47-1/2" SWING BEAM MOUNT ONTO THE CARRIAGE BOLTS STICKING OUT FROM THE CORNER POSTS, MAKE SURE THE CARRIAGE BOLT GOES ALL THE WAY INTO THE SWING BEAM MOUNT. USE 3/8" WASHERS AND 3/8" LOCK NUTS TO SECURE THE SWING BEAM MOUNT.

3: PLACE THE SWING BEAM PLATE ON TOP OF THE SWING BEAM MOUNT, LINING UP THE PILOT HOLES. FASTEN THE SWING BEAM PLATE TO THE SWING BEAM MOUNT USING 3-1/2" CARRIAGE BOLTS ON TOP AND 3/8" LOCK NUTS WITH 3/8" WASHERS FROM UNDERNEATH, IN THE COUNTER BORED HOLES OF THE SWING BEAM MOUNT.

4: LEAVE THE MIDDLE HOLE EMPTY, IT WILL BE USED LATER.

5: USE BOLT CAPS TO COVER ANY EXPOSED THREADS.

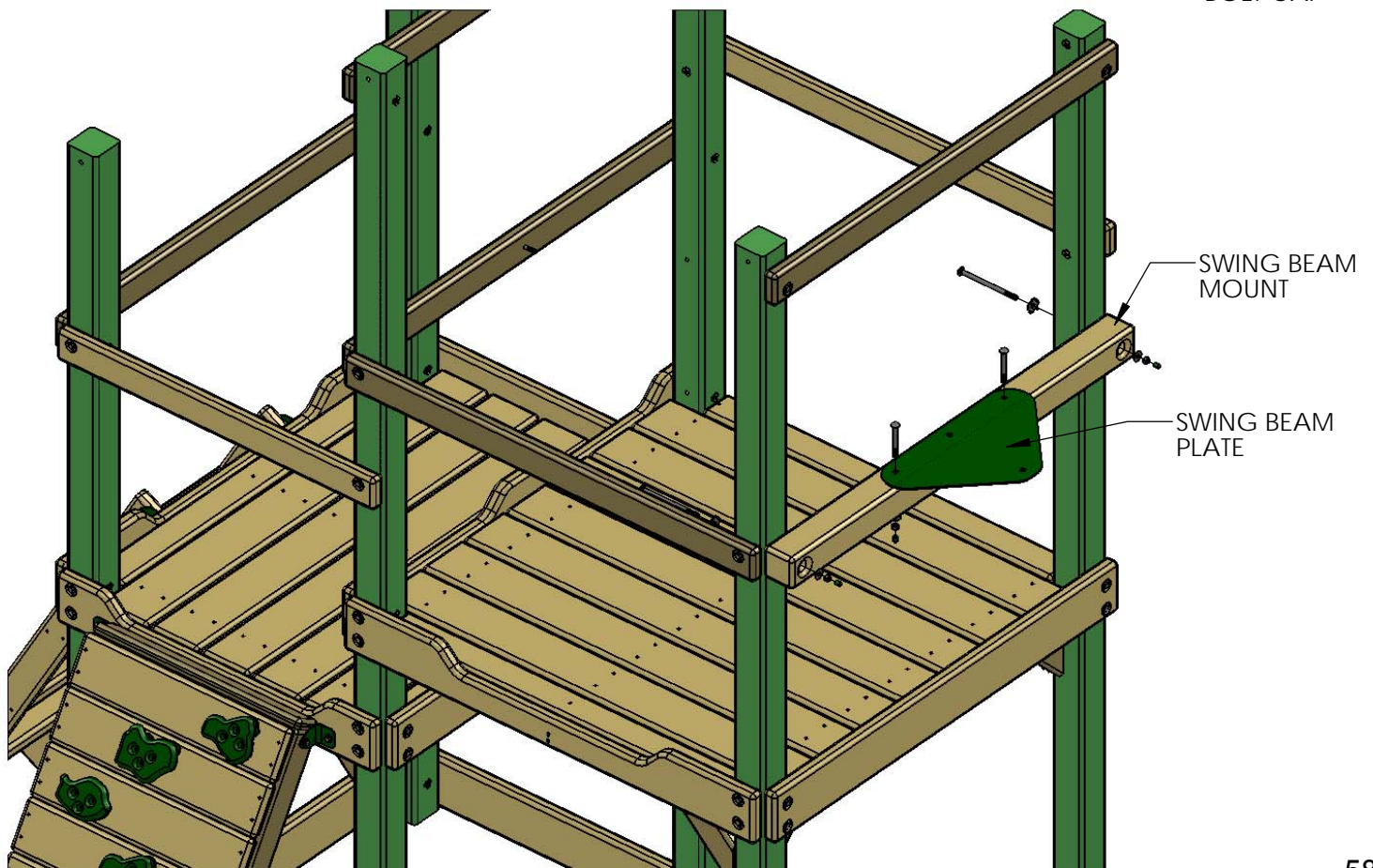
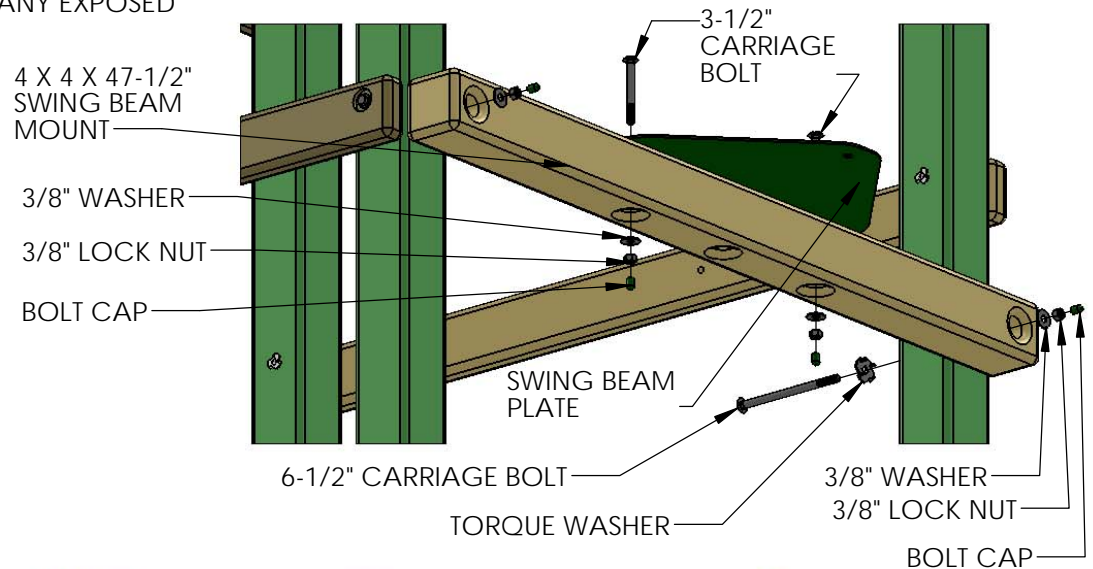

## STEP 26: IRON DUCTILES

- 1: LINE UP THE HOLES OF THE IRON DUCTILE SWING HANGERS WITH THE HOLES IN THE SWING BEAM.
- 2: FASTEN THE SWING HANGERS TO THE SWING BEAM USING 7" CARRIAGE BOLTS WITH TORQUE WASHERS, AND 3/8" WASHERS WITH 3/8" LOCK NUTS.
- 3: PLACE BOLT CAPS OVER EXPOSED THREADS.

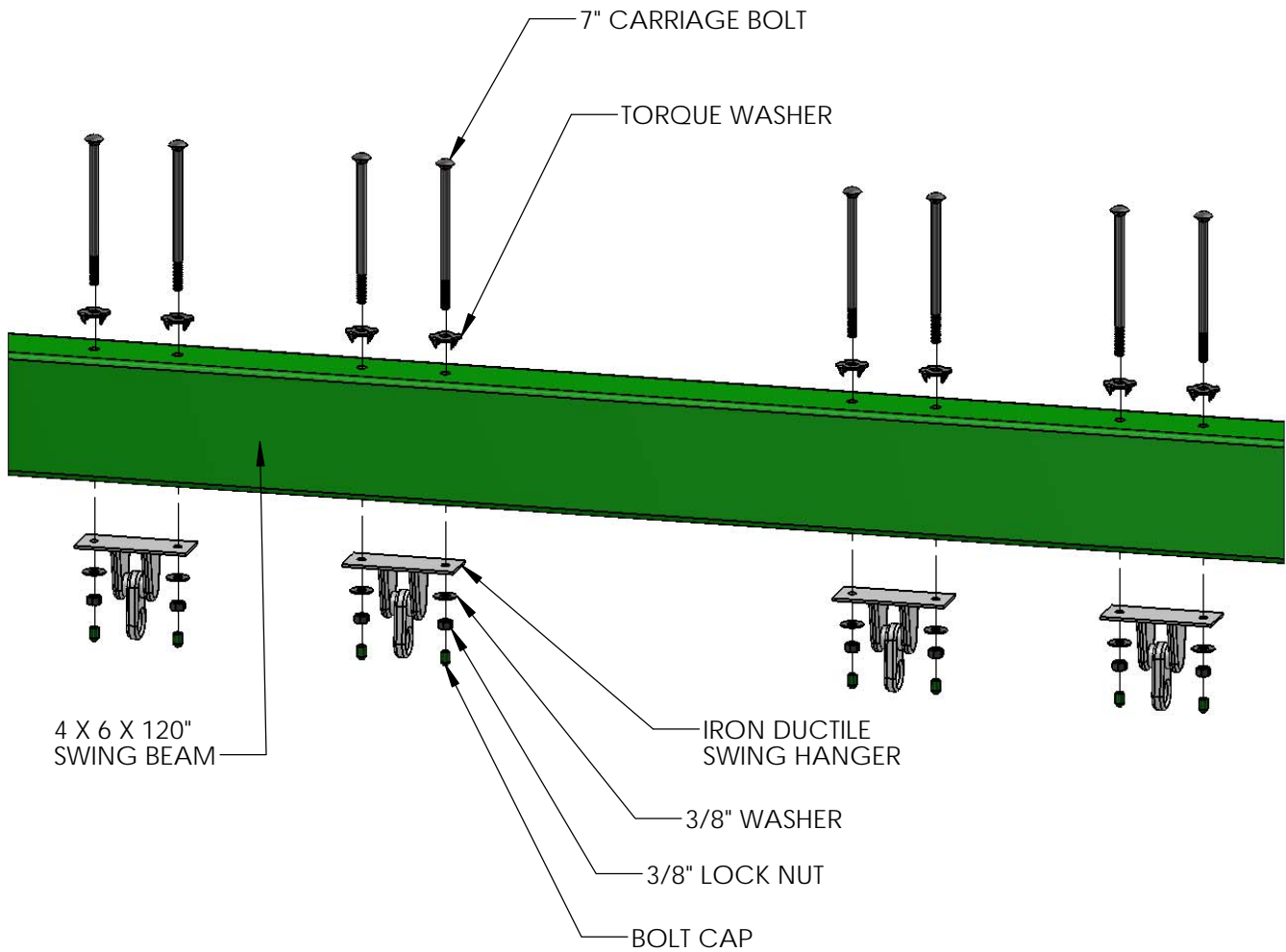

## STEP 27: ATTACH SWING LEGS TO BRACKET

1: PLACE THE 4 X 4 X 108" SWING LEGS FLUSH TO THE TOP OF THE SWING LEG BRACKET.

2: FASTEN THE SWING LEGS TO THE SWING LEG BRACKET WITH 3/8" X 3-1/2" LAG SCREWS AND 3/8" WASHERS.

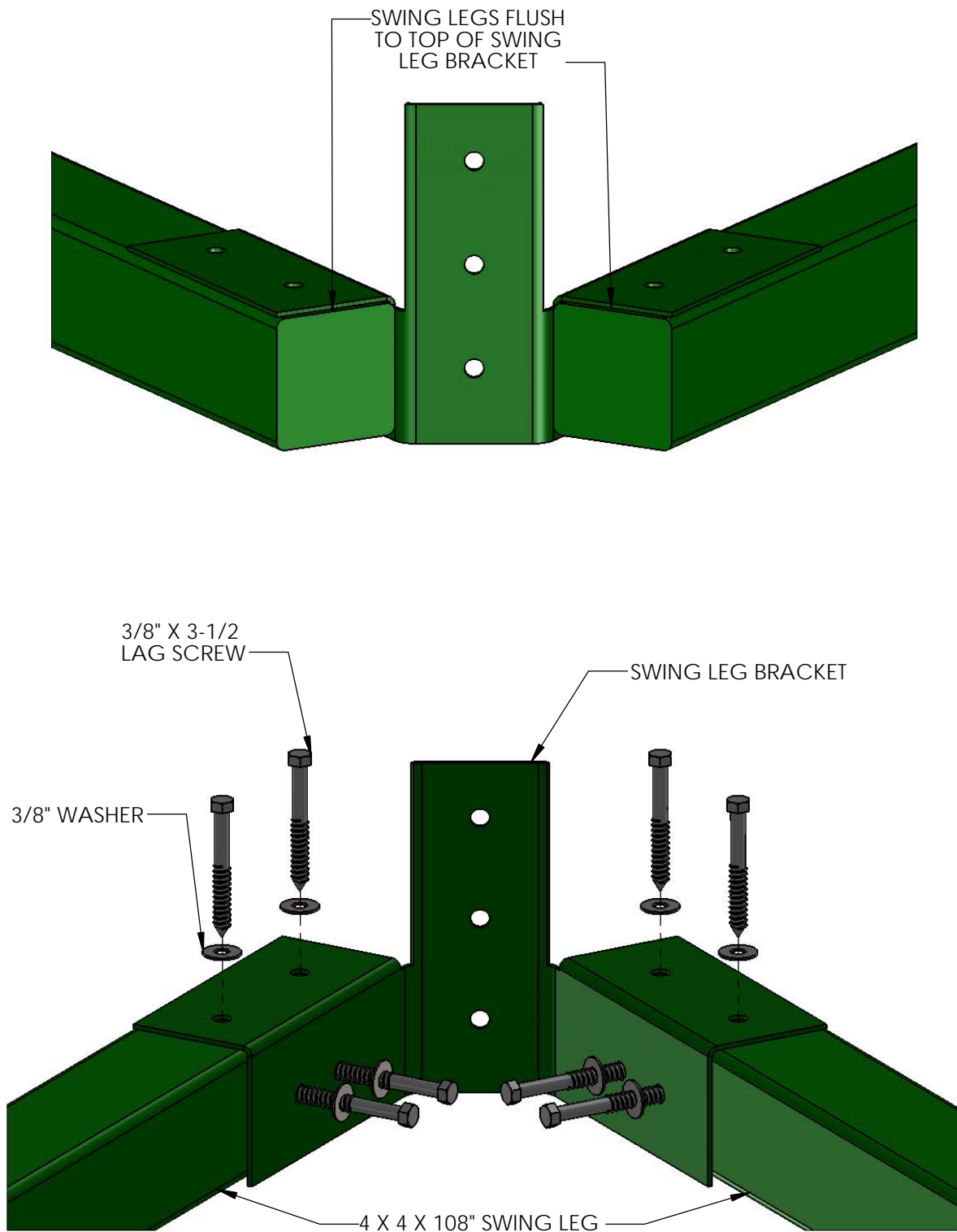

## STEP 28: REST SWING BEAM ON FORT

AN EXTRA PERSON IS NEEDED FOR THIS STEP.

1: SIT THE SWING BEAM LEGS UPRIGHT.

2: LINE UP THE PRE-DRILLED HOLES AND REST THE SWING BEAM ON TOP OF THE FORT AND THE SWING BEAM LEGS. MAKE SURE THAT YOU HAVE THE BEAM FACING THE RIGHT WAY.





## STEP 29: MOUNT SWING BEAM TO SWING BEAM LEGS

1: FASTEN THE SWING BEAM TO THE SWING BEAM BRACKET USING 7" CARRIAGE BOLTS WITH TORQUE WASHERS ON TOP OF THE SWING BEAM, AND 3/8" LOCK NUTS WITH 3/8" WASHERS FROM UNDERNEATH.

2: USE A 3/8 X 3-1/2" LAG SCREW WITH 3/8" WASHER FOR THE HOLE IN THE CENTER OF THE SWING LEG BRACKET.

3: PLACE A BOLT CAP OVER ANY EXPOSED THREADS.

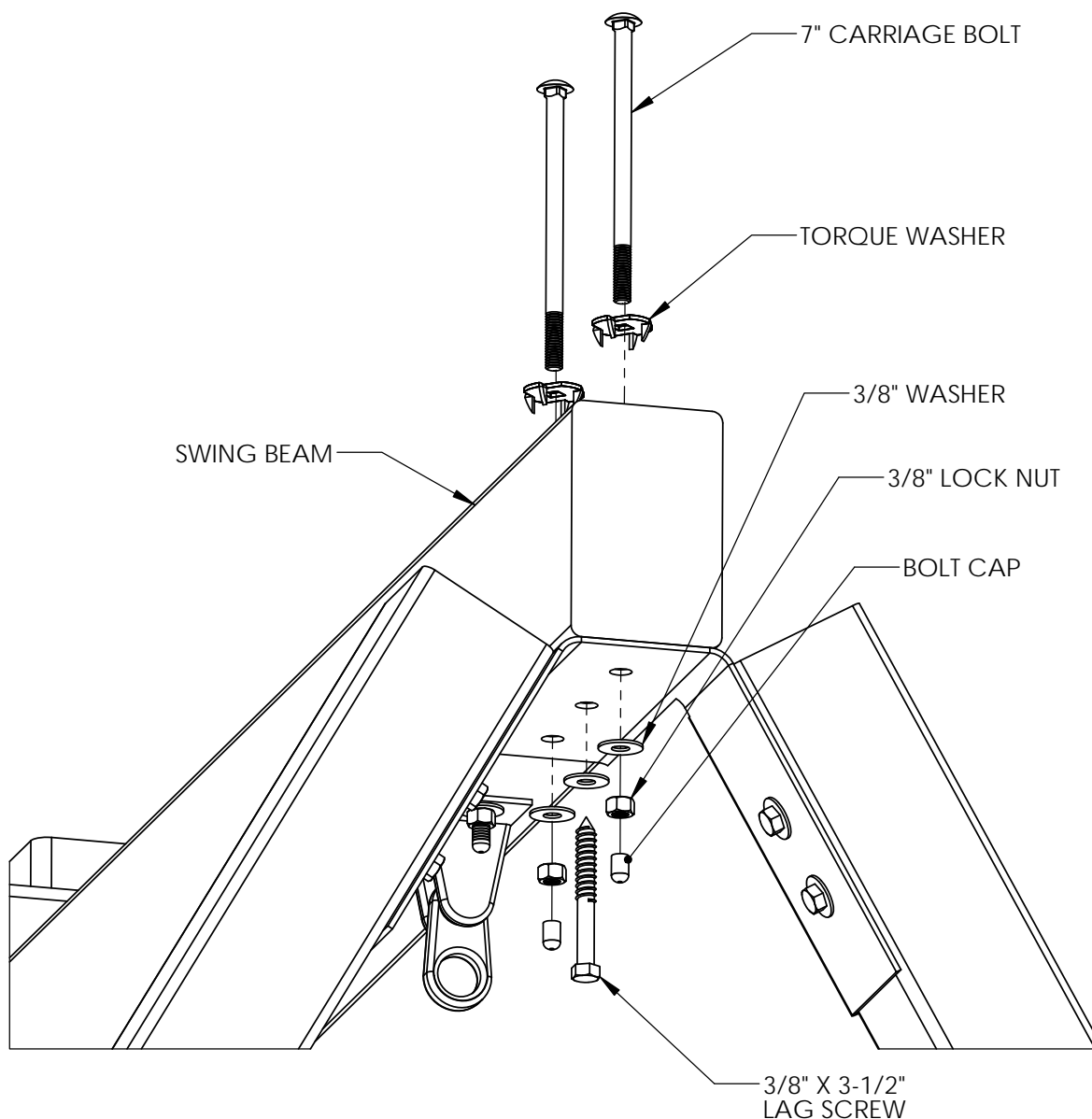

## STEP 30: MOUNT SWING BEAM ON FORT

AN EXTRA PERSON IS NEEDED FOR THIS STEP.

- 1: HAVE A PERSON WALK THE SWING BEAM OUT TO THE END OF THE FORT FROM INSIDE THE FORT WHILE THE OTHER PERSON CARRIES IT BY THE LEGS.
- 2: LINE UP THE PILOT HOLE AT THE END OF THE SWING BEAM WITH THE MIDDLE HOLE ON THE SWING BEAM PLATE.
- 3: FASTEN THE SWING BEAM TO THE SWING BEAM PLATE AND SWING BEAM MOUNT USING A 9" CARRIAGE BOLT WITH A TORQUE WASHER ON TOP AND A 3/8" LOCK NUT AND WASHER ON THE BOTTOM. PLACE GREEN BOLT CAPS OVER EXPOSED THREADS AFTER SECURING.
- 4: FASTEN THE SWING BEAM TO THE SWING BEAM PLATE FROM UNDERNEATH WITH A 3/8 X 3-1/2" LAG SCREW AND 3/8" WASHER.

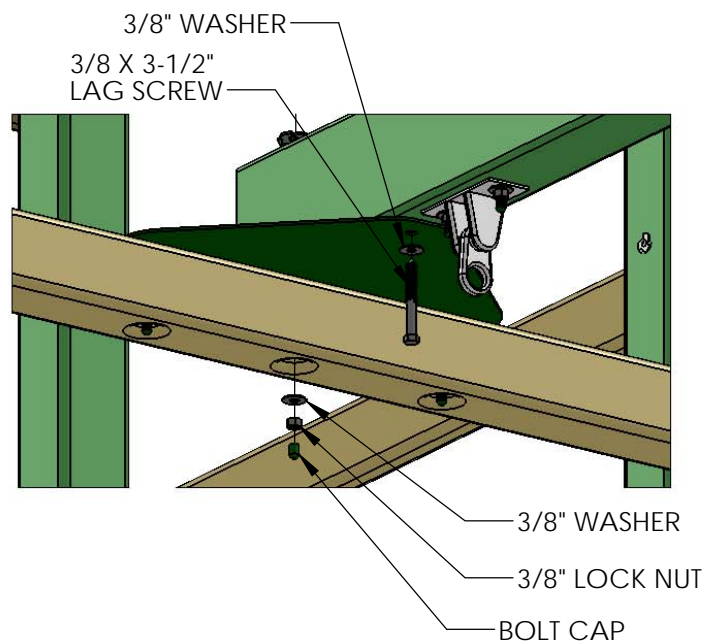
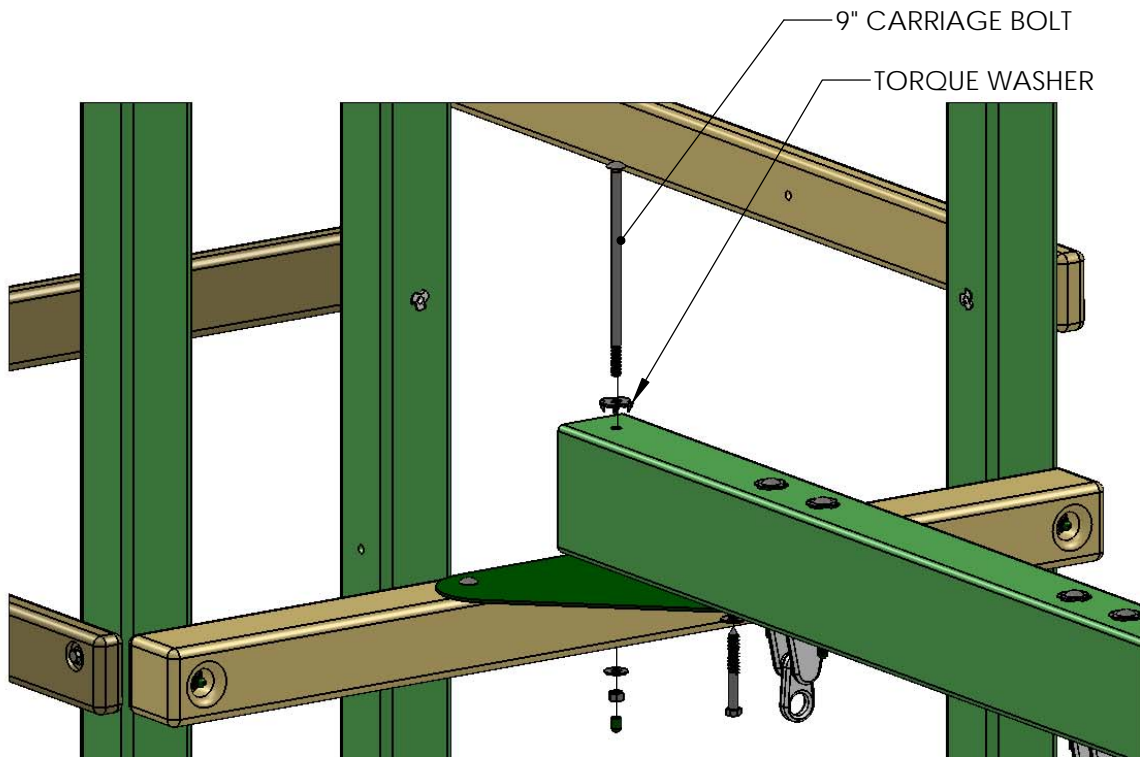

## STEP 31: LEVEL SWING BEAM

1: PLACE A LEVEL ON TOP OF THE SWING BEAM AND ADJUST THE LEGS IN OR OUT AS NEEDED TO MAKE THE SWING BEAM LEVEL.



IMPORTANT NOTE:  
THE LEGS ARE DESIGNED TO  
ACCOMMODATE SWING BEAMS ON  
UNEVEN GROUND (DOWN SLOPE).  
THEY ARE LONGER THAN REQUIRED.  
IF YOUR GROUND IS RELATIVELY  
LEVEL, YOU MAY NEED TO EITHER:  
A) DIG IN BOTH LEGS WHERE THEY  
MEET THE GROUND, OR  
B) BEND THE LEGS OUT SLIGHTLY TO  
MATCH YOUR GRADE.

## STEP 32: SWING LEG CROSS-MEMBER

- 1: POSITION THE 2 X 4 X 58" SWING LEG CROSS-MEMBER AGAINST THE SWING BEAM LEGS.
- 2: LEVEL THE CROSS-MEMBER AND MARK THE LOCATION OF THE SECURING HOLES INSIDE THE CROSS-MEMBER HOLES.
- 3: USE 3/8 X 3-1/2" LAG SCREWS WITH 3/8" WASHERS TO SECURE THE CROSS-MEMBER TO THE SWING BEAM LEGS.

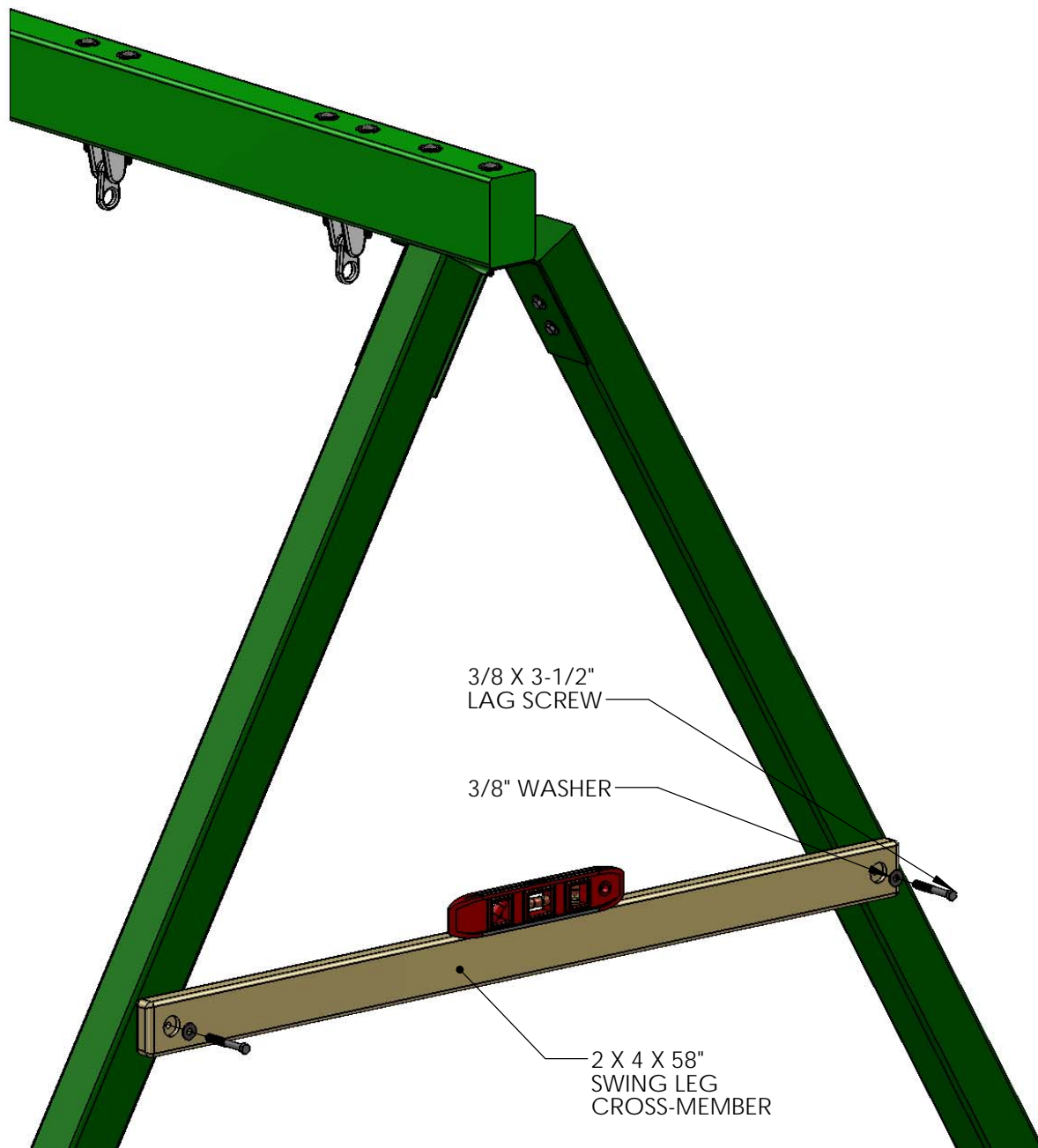

## STEP 33: ROOF SUPPORTS AND ROOF PEAK SUPPORT

1: WITH OFFSET HOLES DOWN, ATTACH THE 2 X 4 X 35-1/2" ROOF SUPPORTS TO THE FORT WITH 5/16" X 4-1/2" HEX BOLTS AND 5/16" WASHERS. THE ROOF SUPPORTS SHOULD MEET IN THE MIDDLE TO FORM A RIGHT ANGLE.

2: PLACE THE 5/4" X 10-1/2" ROOF PEAK SUPPORT AGAINST THE ANGLED ROOF SUPPORTS AND FLUSH TO THE SIDES OF THE ANGLED ROOF SUPPORTS. FASTEN THE ROOF PEAK SUPPORT TO THE ANGLED ROOF SUPPORTS WITH 2" WOOD SCREWS. REPEAT ON THE OTHER SIDE.

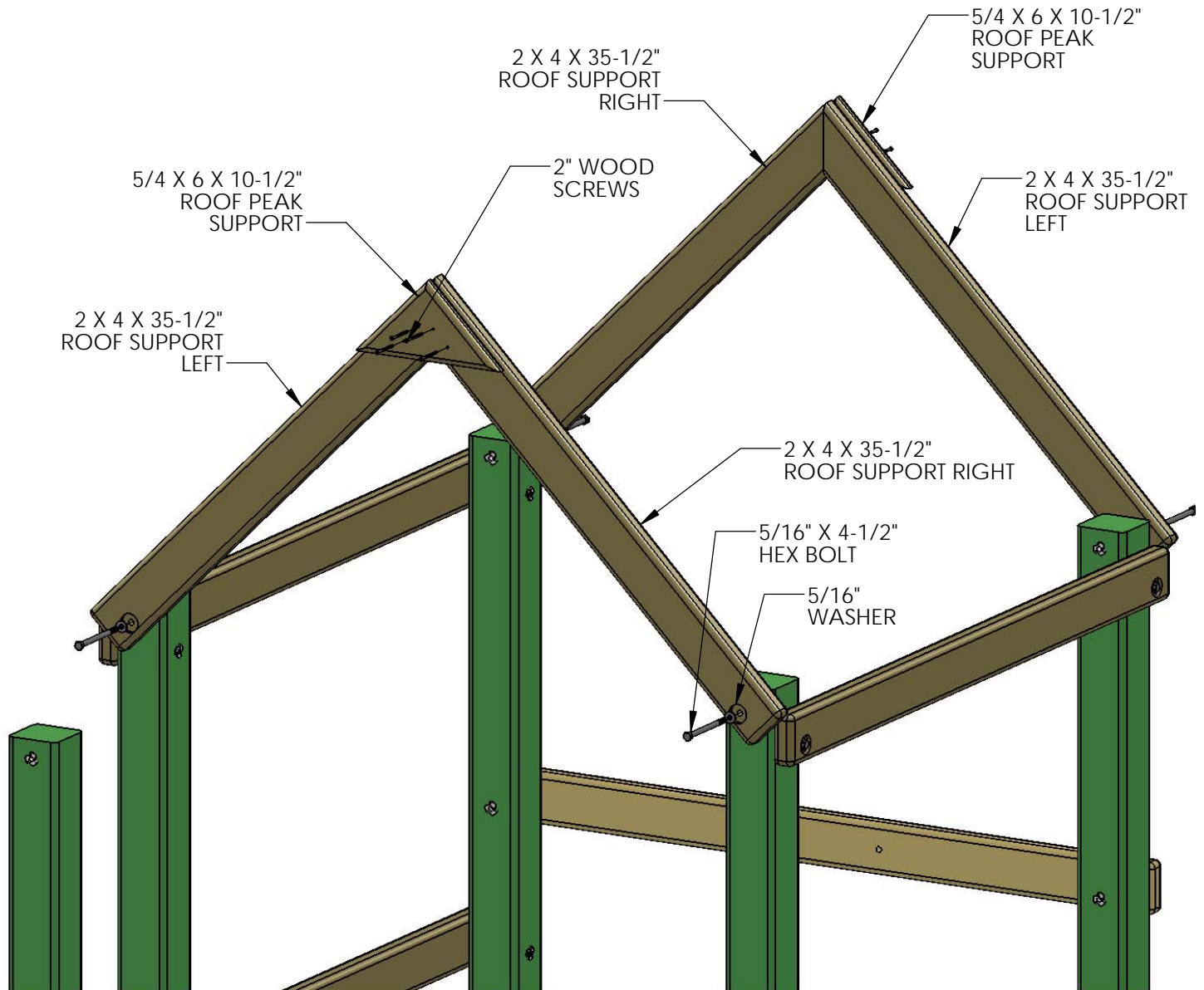

## STEP 34: ROOF STARTER BOARDS

1: PLACE THE 1 X 4 X 52" ROOF STARTER BOARDS AT THE PEAK OF THE ROOF. THE HOLES IN THE ROOF STARTERS SHOULD BE CENTERED ON THE ROOF SUPPORTS, AND THE FLAT ENDS OF THE ROOF STARTERS SHOULD BE PLACED AS CLOSE TO EACH OTHER AS POSSIBLE WITHOUT THE BOARDS OVERLAPPING.

2: FASTEN THE ROOF STARTER BOARDS TO THE ROOF SUPPORTS WITH 1-1/2" WOOD SCREWS.

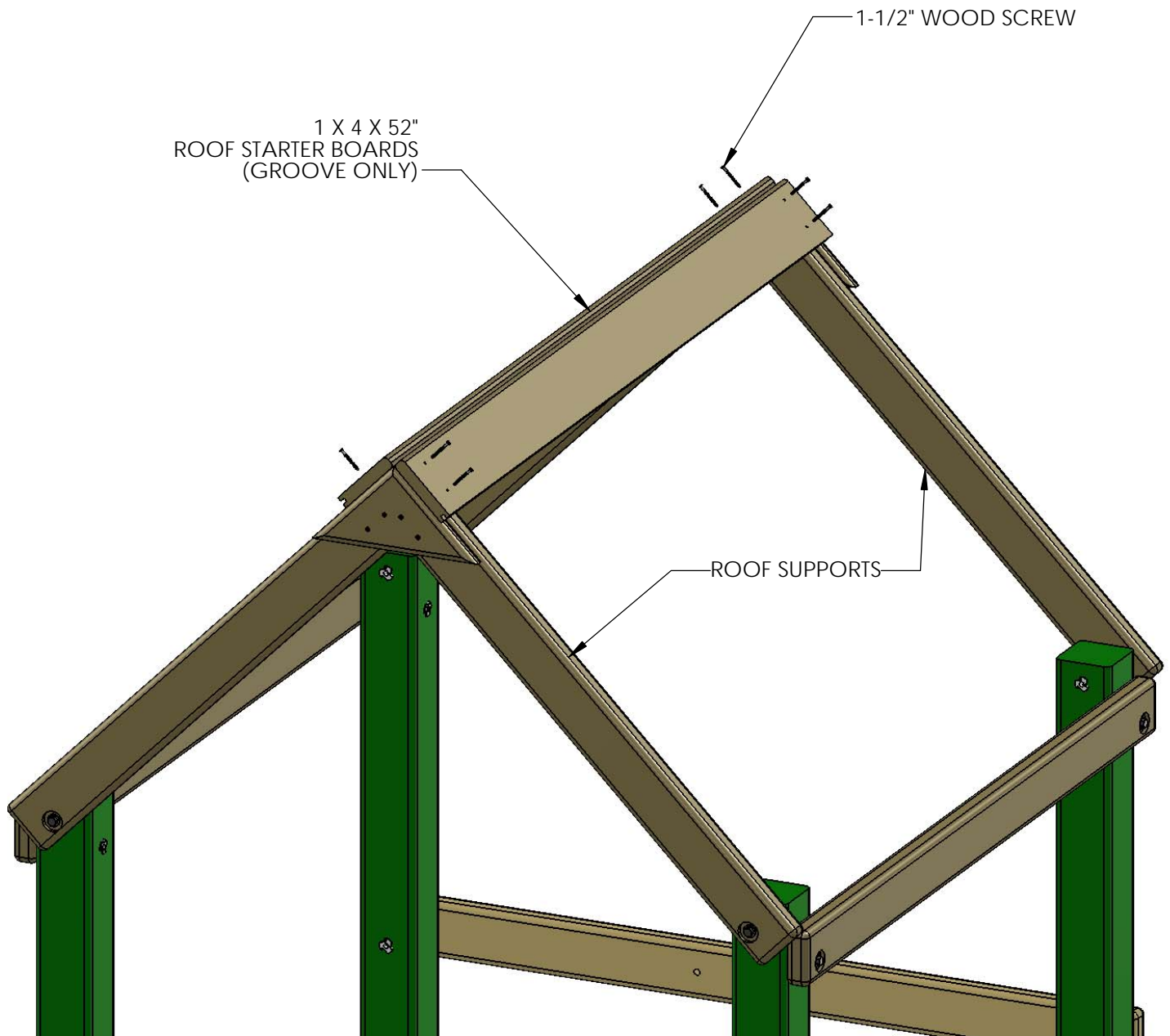

## STEP 35: ROOF PEAK

1: PLACE THE 1 X 4 X 52" ROOF PEAK ON TOP OF THE ROOF STARTER BOARDS.

2: FASTEN THE ROOF PEAK TO THE ROOF STARTER BOARDS WITH 1-1/4" WOOD SCREWS THROUGH THE PRE DRILLED HOLES TO THE ROOF STARTER BOARDS PREVIOUSLY INSTALLED.

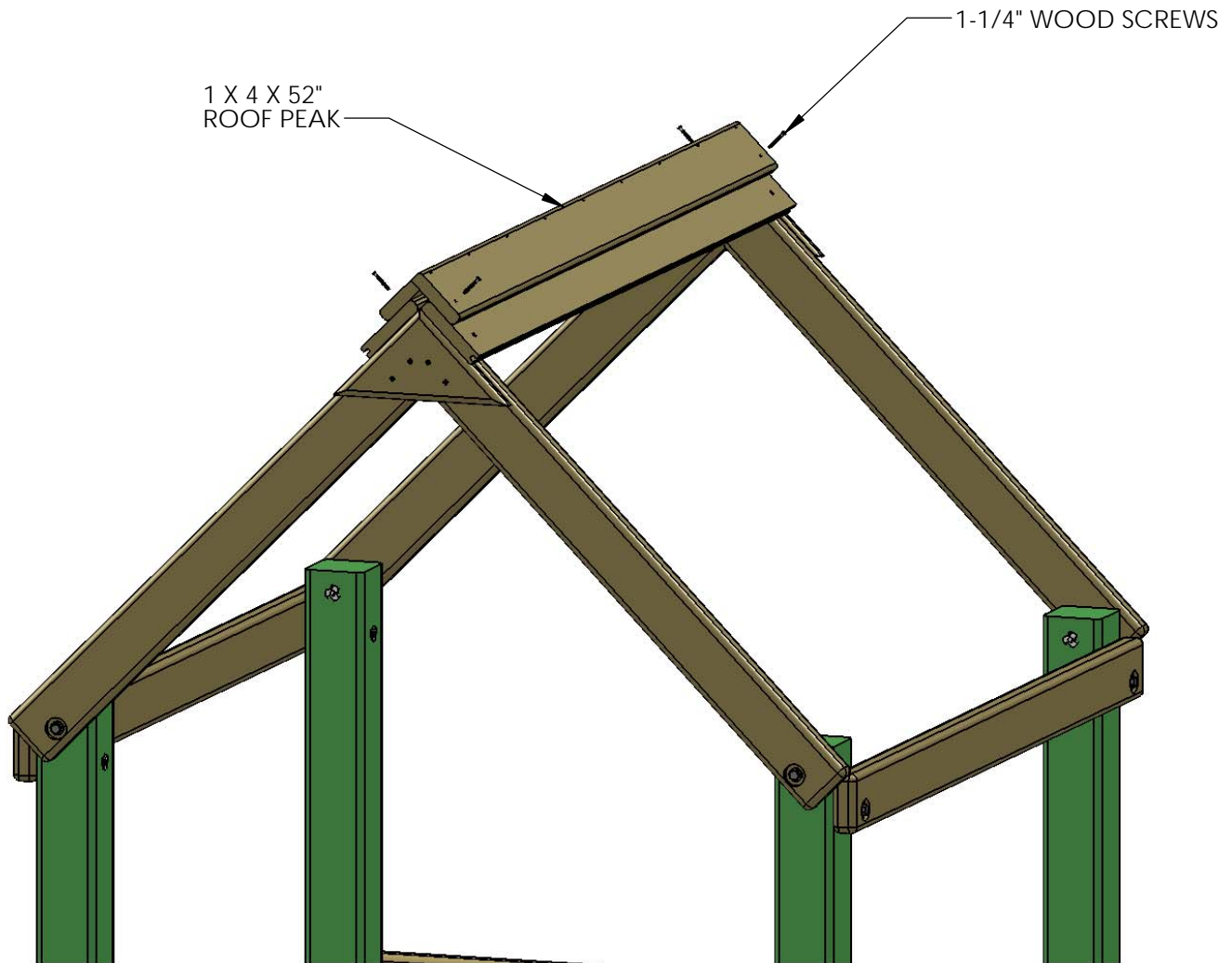



## STEP 36: ROOF BOARDS AND ROOF FINISHER

- 1: PLACE THE 1 X 5 X 52" ROOF BOARDS ON TOP OF THE ROOF SUPPORTS, FITTING THE TONGUE INTO THE GROOVE END OF THE ROOF STARTERS. EACH SIDE OF THE ROOF GETS SEVEN ROOF BOARDS.
- 2: FASTEN THE ROOF BOARDS TO THE ROOF SUPPORTS WITH 1-1/2" WOOD SCREWS.
- 3: PLACE A 1 X 4 X 52" ROOF FINISHER AT THE END OF THE ROOF ASSEMBLY, AND FASTEN WITH 1-1/2" WOOD SCREWS. EACH SIDE OF THE ROOF GETS ONE ROOF FINISHER.
- 4: REPEAT SUB STEPS 1-3 FOR THE OTHER SIDE OF THE ROOF.

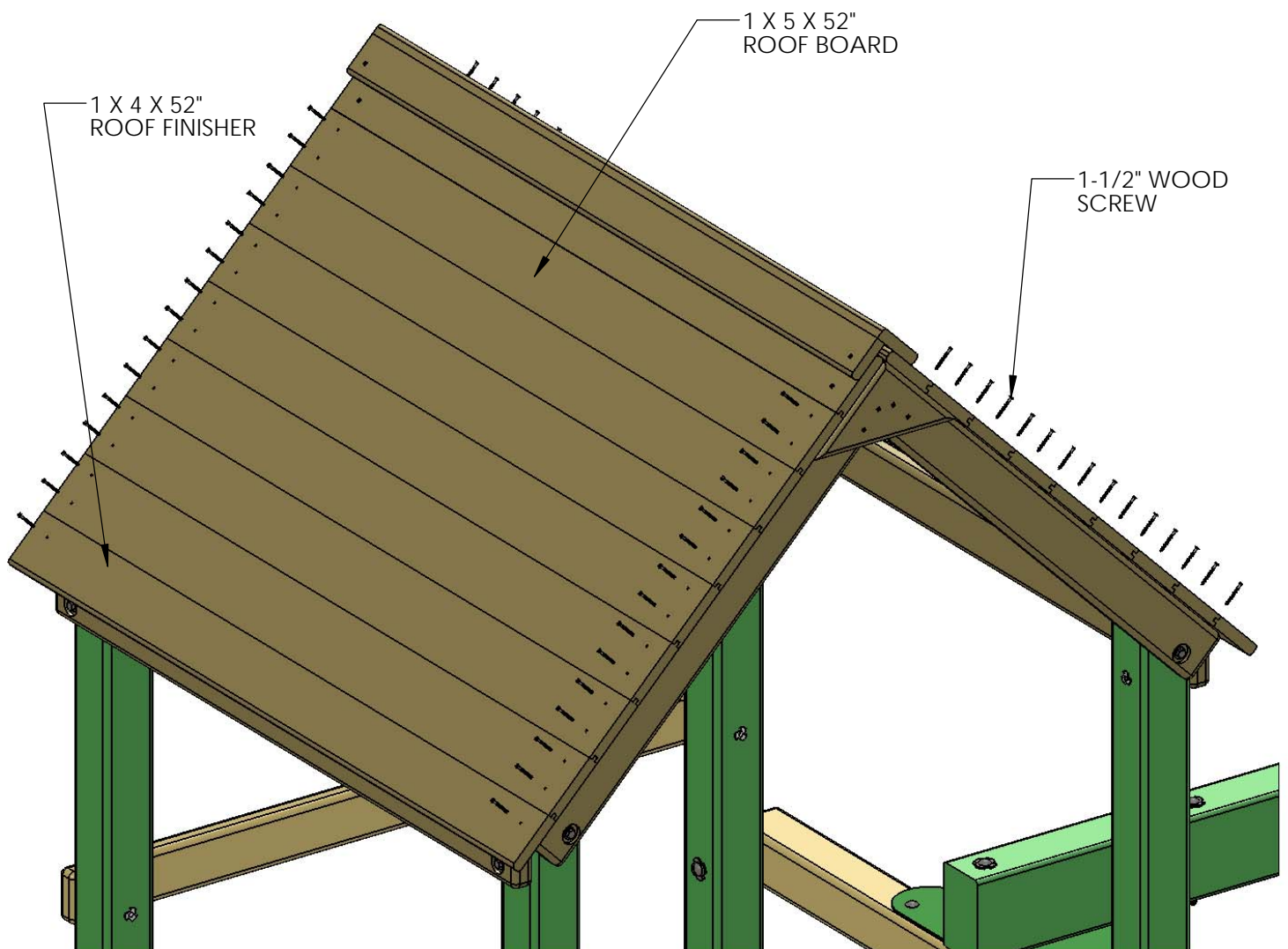

## STEP 37: DORMERS AND CHIMNEY

1: USE THE INSTRUCTIONS PROVIDED TO ASSEMBLE AND INSTALL THE CHIMNEY AND DORMERS.

2: FASTEN THE CHIMNEY AND DORMERS TO THE ROOF IN THE LOCATIONS SHOWN BELOW USING THE FASTENERS DESCRIBED IN THE CHIMNEY AND DORMER MANUAL.

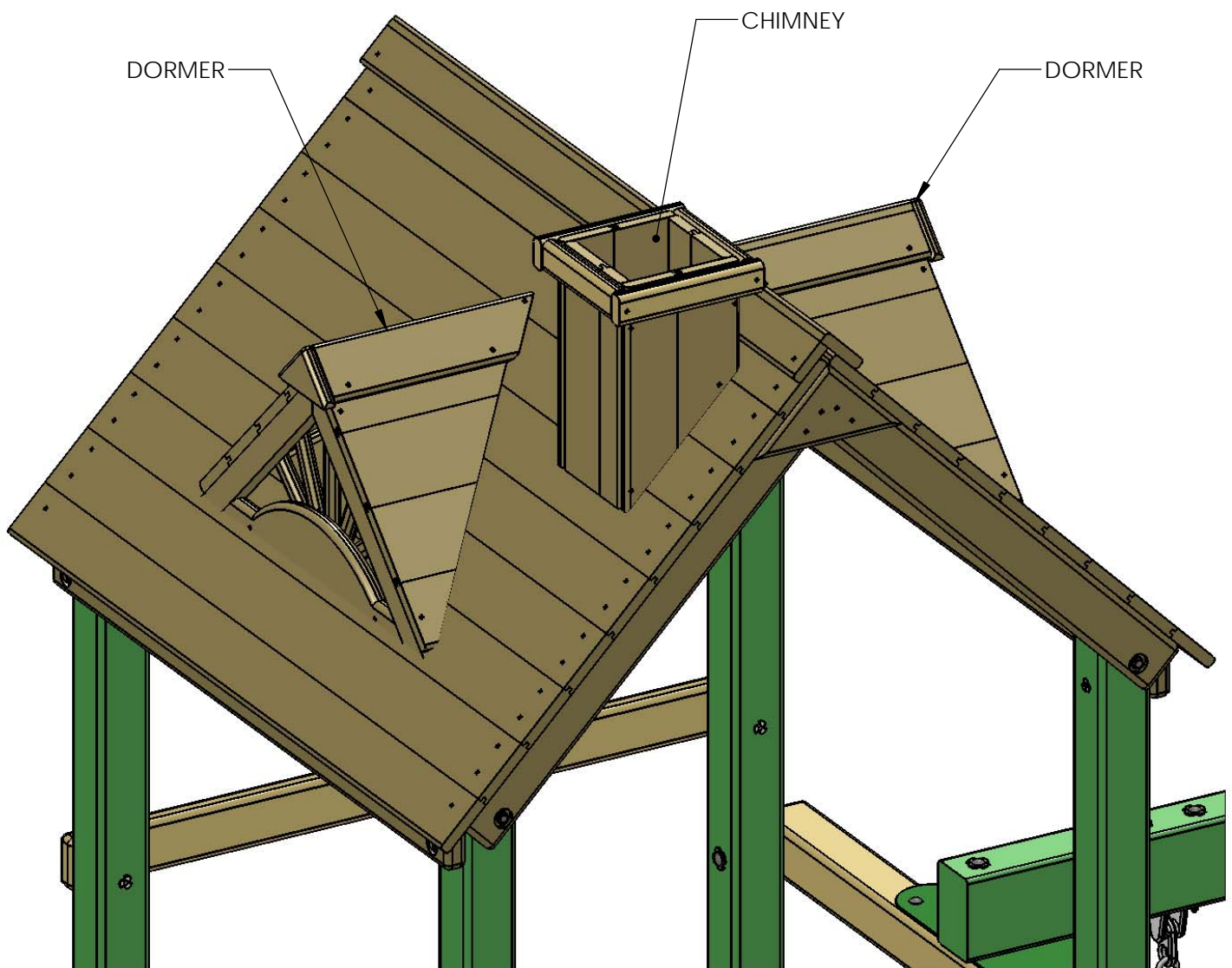

## STEP 38: SUN BURST SUPPORT AND SUN

- 1: CENTER THE 2 X 6 X 16" SUN ON TOP OF THE SUN BURST SUPPORT, AND ATTACH USING TWO 3" WOOD SCREWS.
- 2: PLACE THE 2 X 4 X 45" SUN BURST SUPPORT IN BETWEEN THE ROOF SUPPORTS. FASTEN USING 2-1/2" WOOD SCREWS THROUGH THE PREDRILLED HOLES ON EACH END, MAKE SURE THERE ARE NO GAPS IN BETWEEN THE SUN BURST AND THE ROOF SUPPORT.
- 3: REPEAT FOR THE OTHER SIDE OF THE FORT.

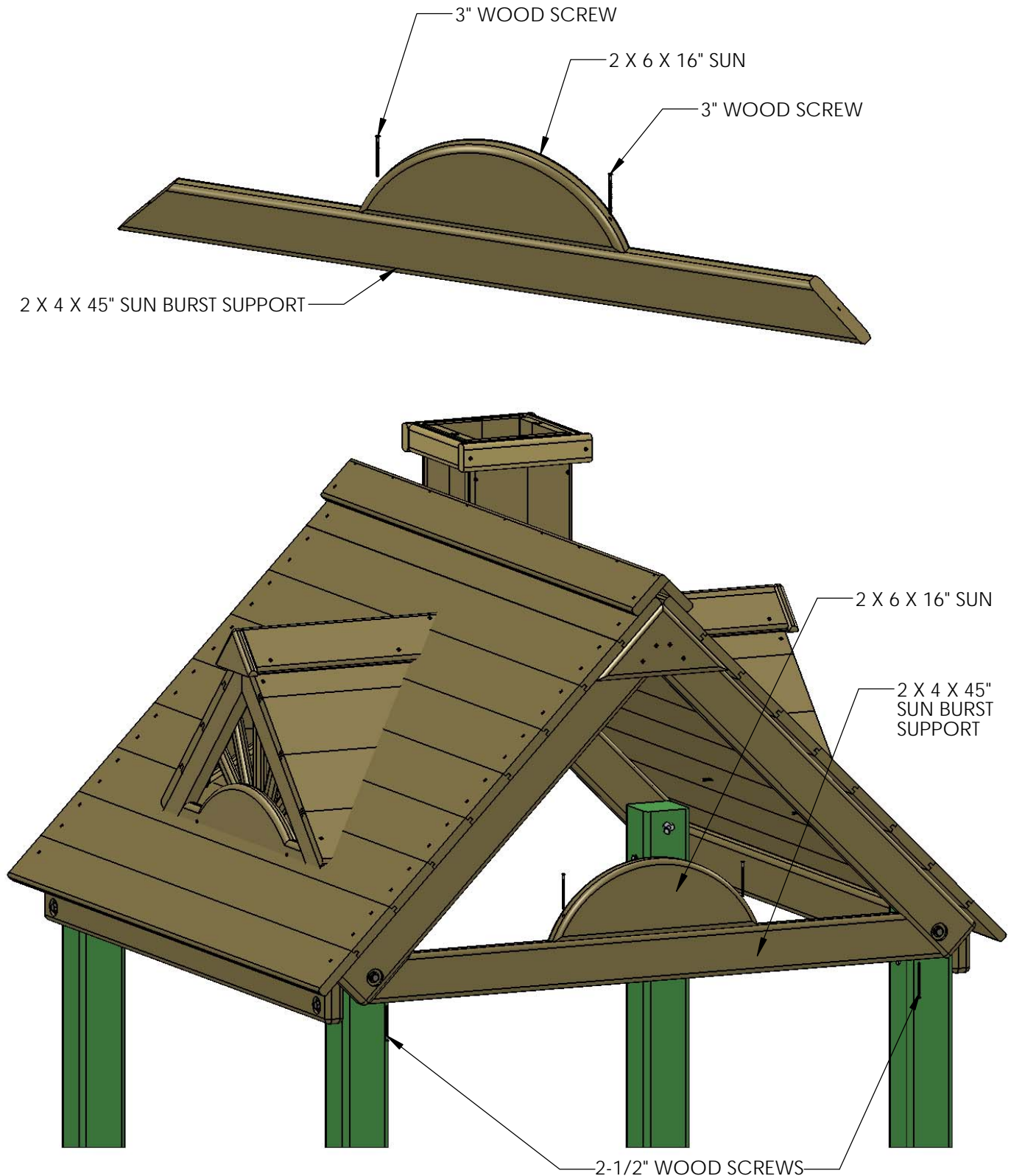

## STEP 39: SUN RAYS

- 1: CENTER THE 5/4 X 4 X 19" SUN RAY ONTO THE SUN AND THE ROOF SUPPORT BOARDS AND FASTEN WITH TWO 2" WOOD SCREWS.
- 2: EQUALLY SPACE ONE 5/4 X 4 X 13" SUN RAY AND ONE 5/4 X 4 X 12" SUN RAY IN BETWEEN THE CENTER SUN RAY PREVIOUSLY INSTALLED AND THE SUNBURST SUPPORT. USE TWO 2" WOOD SCREWS TO FASTEN EACH SUN RAY TO THE ROOF SUPPORT AND SUN.
- 3: REPEAT SUB STEP 2 ON THE OTHER SIDE OF THE CENTER SUN RAY.
- 4: REPEAT SUB STEPS 1-3 FOR THE OPPOSITE SIDE OF THE FORT.

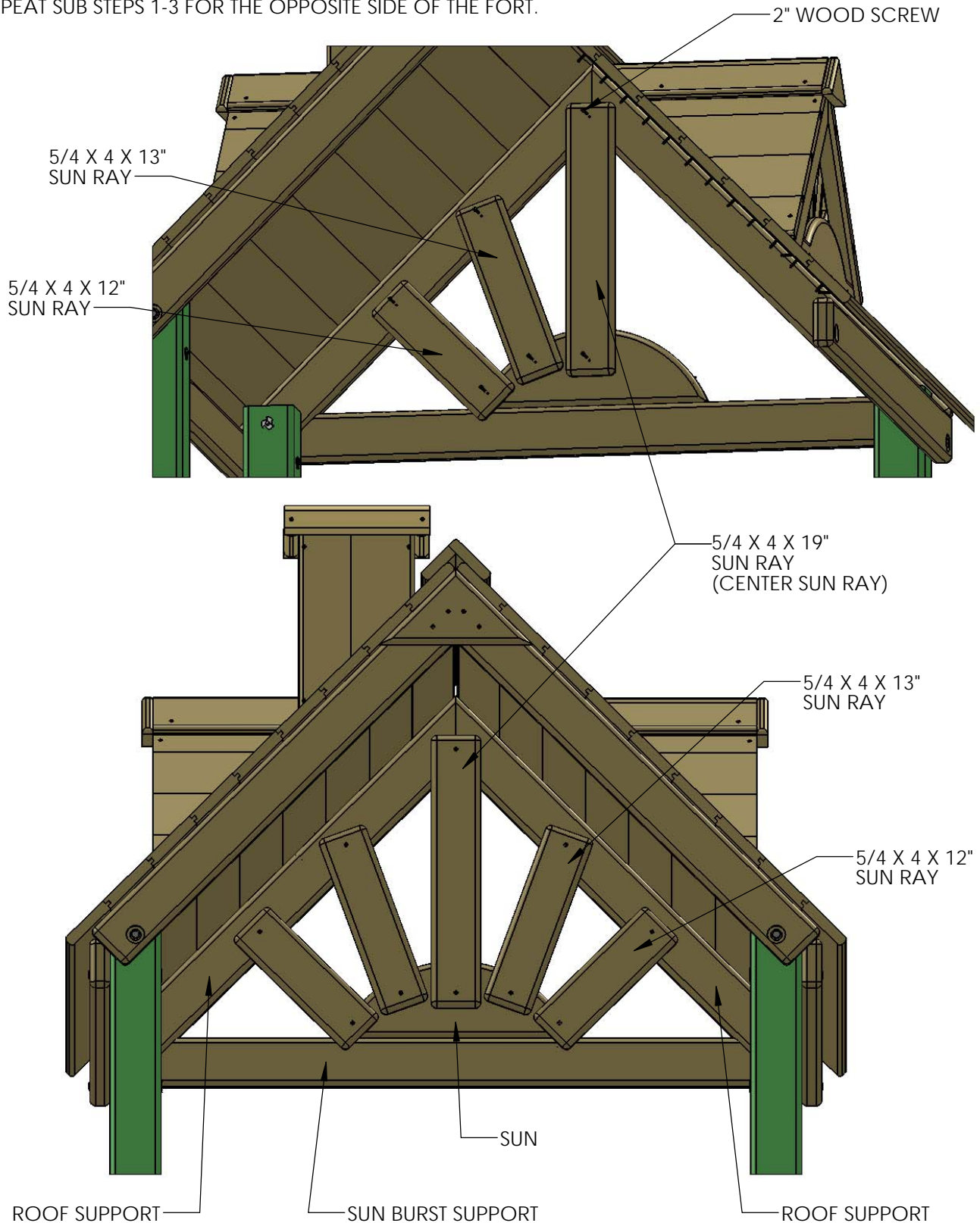



## STEP 40: RADRIDE ANGLE SUPPORT

1: MOUNT THE 2 X 4 X 13" ANGLE SUPPORT UNDERNEATH THE DECK, MAKE SURE IT IS FLUSH AGAINST THE CORNER POST AND THE DECK SPACER. FASTEN THE BOTTOM OF THE ANGLE SUPPORT TO THE CORNER POST USING A 3" WOOD SCREW THROUGH THE TOP PREDRILLED HOLE AND A 2" WOOD SCREW THROUGH THE BOTTOM PREDRILLED HOLE.

2: INSERT TWO 2-1/2" WOOD SCREWS THROUGH THE TOP OF THE DECK SPACER INTO THE TOP OF THE ANGLE SUPPORT. MAKE SURE THAT THE TOP OF THE HEAD OF THE WOOD SCREW IS FLUSH TO THE TOP OF THE DECK SPACER.

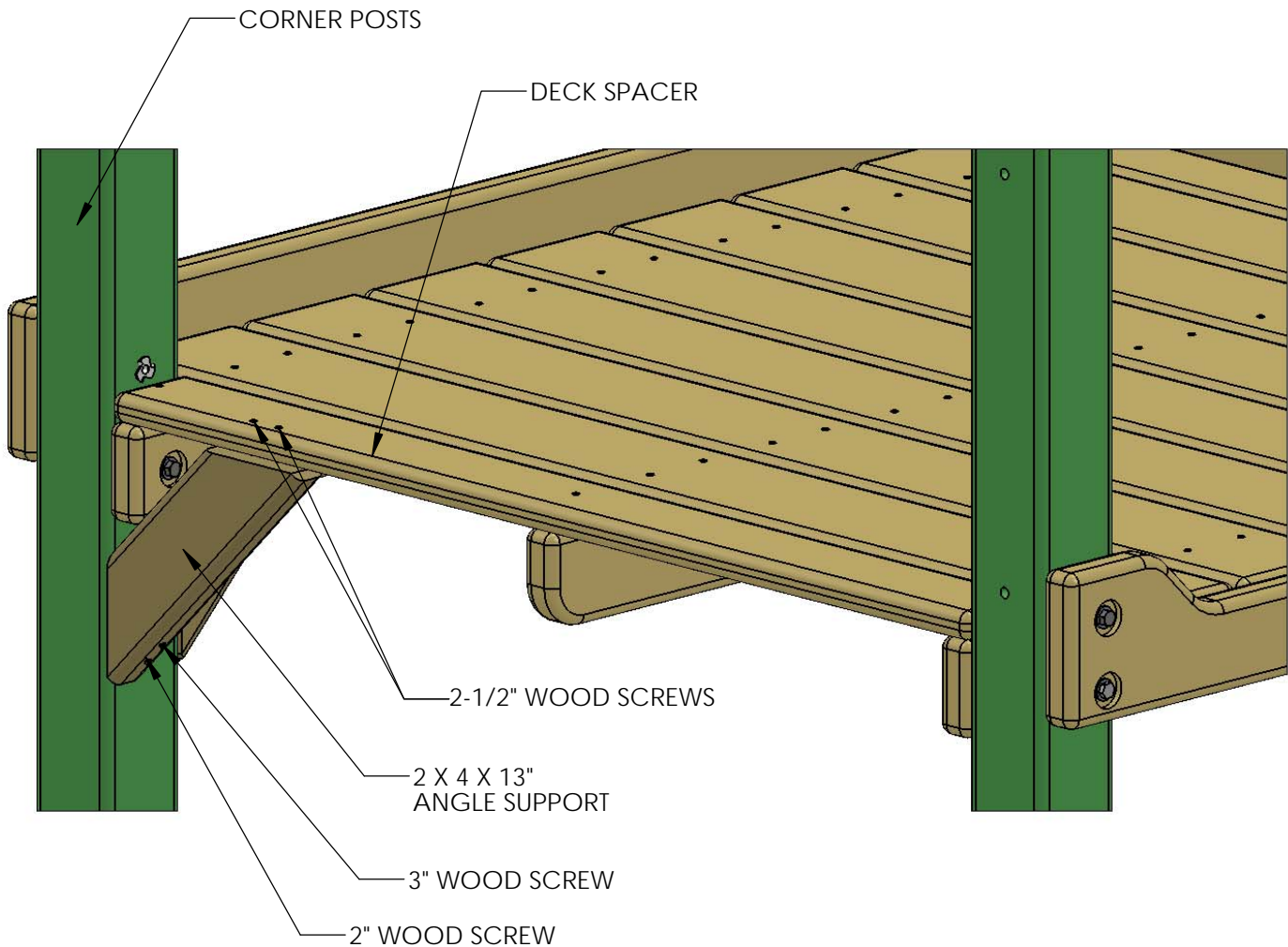

## STEP 41: RADRIDE PANEL WALL

1: LOCATE THE 4 X 4 X 37-5/8" RADRIDE POST, INSERT A T-NUT INTO THE PRE DRILLED HOLE.

2: MOUNT THE RADRIDE POST ON TOP OF THE DECK SPACER AND LINE UP THE PREDRILLED HOLE WITH THE RADRIDE TOP PANEL BOARD CENTER HOLE. FASTEN USING A 5/16" X 4-1/2" HEX BOLT AND 5/16" WASHER.

3: PLACE THE 2 X 6 X 21-1/2" RADRIDE EXIT BOARD ONTO THE REAR OF THE FORT. THE HOLES SHOULD BE OFFSET UP. LINE UP THE TOP HOLE OF THE EXIT BOARD WITH THE HOLE IN THE END REAR CORNER POST. FASTEN THE TOP HOLE TO THE CORNER POST WITH A 5/16" X 4-1/2" HEX BOLT WITH 5/16" WASHER. MAKE SURE THE RADRIDE EXIT BOARD IS HORIZONTALLY LEVEL AND THEN FASTEN THE BOTTOM HOLE WITH A 5/16" X 3-1/2" LAG SCREW AND 5/16" WASHER.

4: MAKE SURE THE 4 X 4 X 37-5/8" RADRIDE POST IS VERTICALLY LEVEL AND FLUSH TO THE EDGE OF THE 2 X 6 EXIT BOARD. INSERT TWO 3" WOOD SCREWS FROM UNDERNEATH THE DECK THROUGH THE DECK SPACER INTO THE 4 X 4 RADRIDE POST.

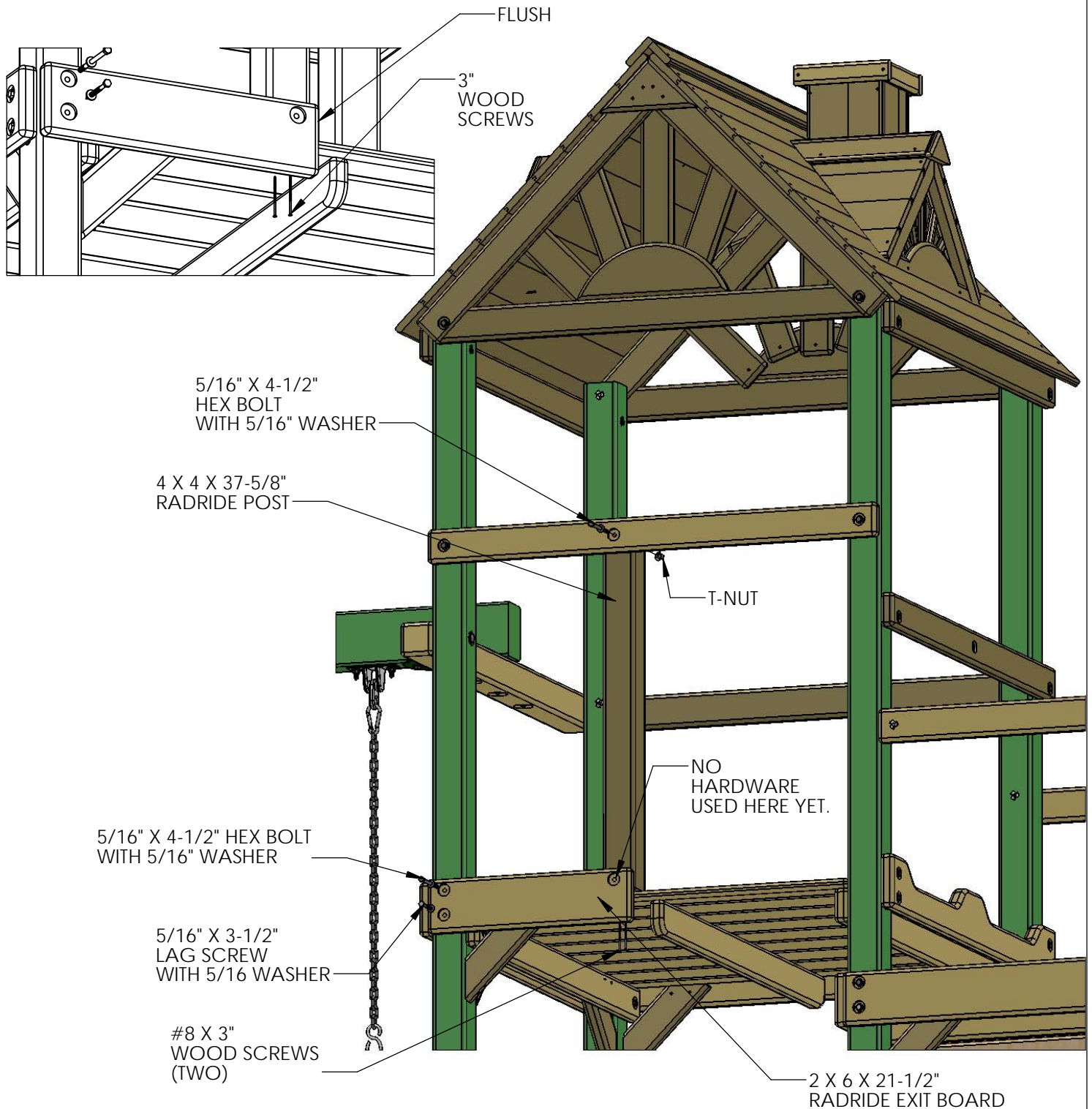

## STEP 42: RADRIDE PANEL SLATS

1: FIND TWO 5/4 X 3 X 36-3/4" PANEL SLATS. MOUNT THEM ON TOP OF THE DECK, EQUALLY SPACED BETWEEN THE RADRIDE POST AND THE CORNER POST. INSERT TWO 2" WOOD SCREW PER SLAT THROUGH THE PREDRILLED HOLES INTO THE TOP PANEL BOARD AND THE RADRIDE EXIT BOARD.

MAKE SURE THE TOP OF THE HEAD OF THE WOOD SCREW IS FLUSH TO THE PANEL SLAT. DO NOT OVERDRIVE.

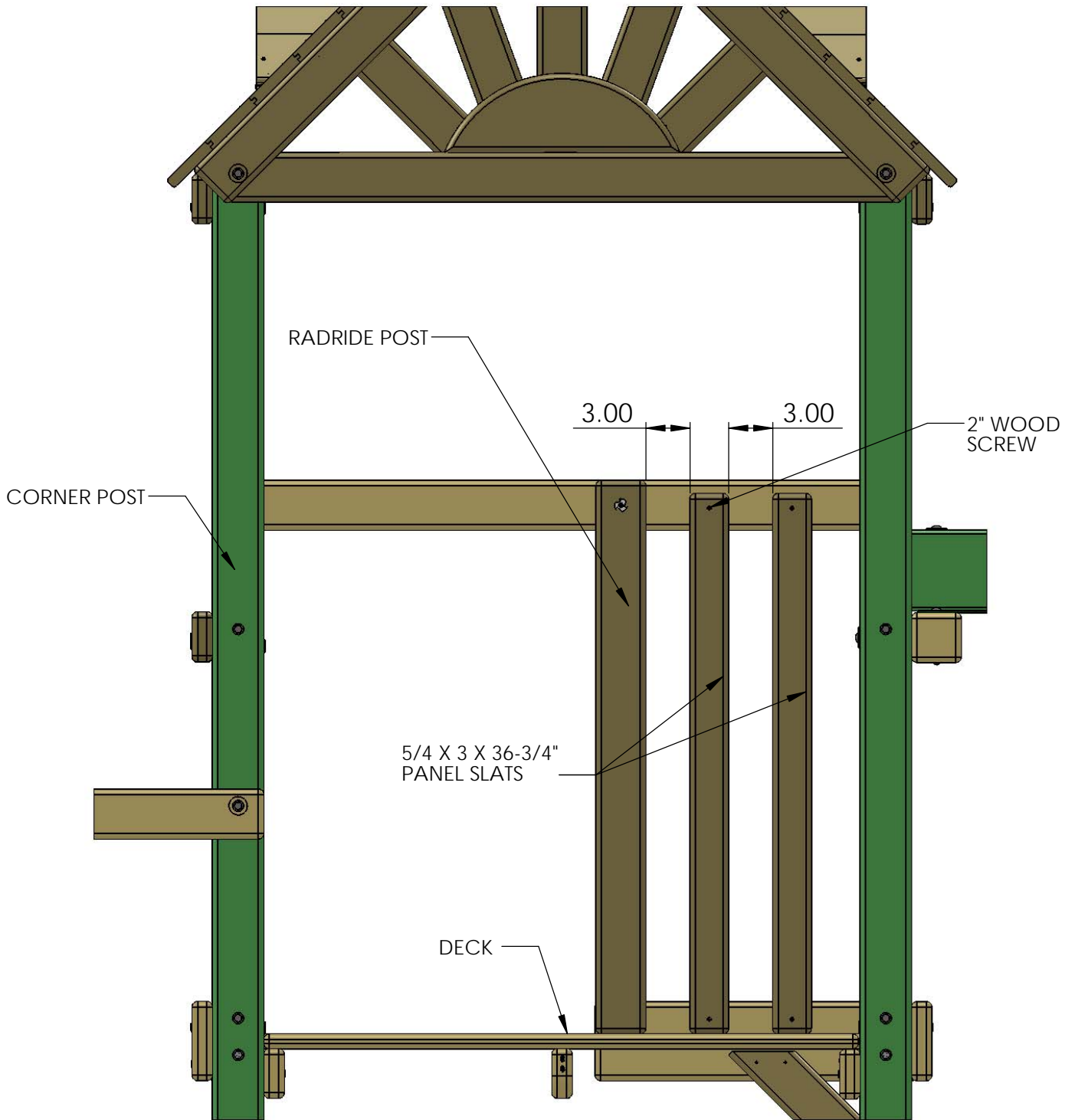

FORT INSIDE VIEW



## STEP 43: CENTER POST

- 1: FIND THE 2 X 4 X 28-11/16" CENTER POST AND INSERT A T-NUT INTO THE TOP PREDRILLED HOLE.
- 2: MOUNT THE CENTER POST ON TOP OF THE SECOND LEVEL DECK AND LINE UP THE CENTER POST T-NUT/HOLE WITH THE MIDDLE PANEL BOARD CENTER HOLE AND SECURE WITH A 5/16" X 2-1/2" HEX BOLT AND 5/16" WASHER.
- 3: MAKE SURE THE CENTER POST IS VERTICALLY LEVEL AND INSERT TWO 2-1/2" WOOD SCREWS THROUGH THE CENTER POST BOTTOM PREDRILLED HOLES INTO THE 2 X 6 ENTRANCE BOARD.

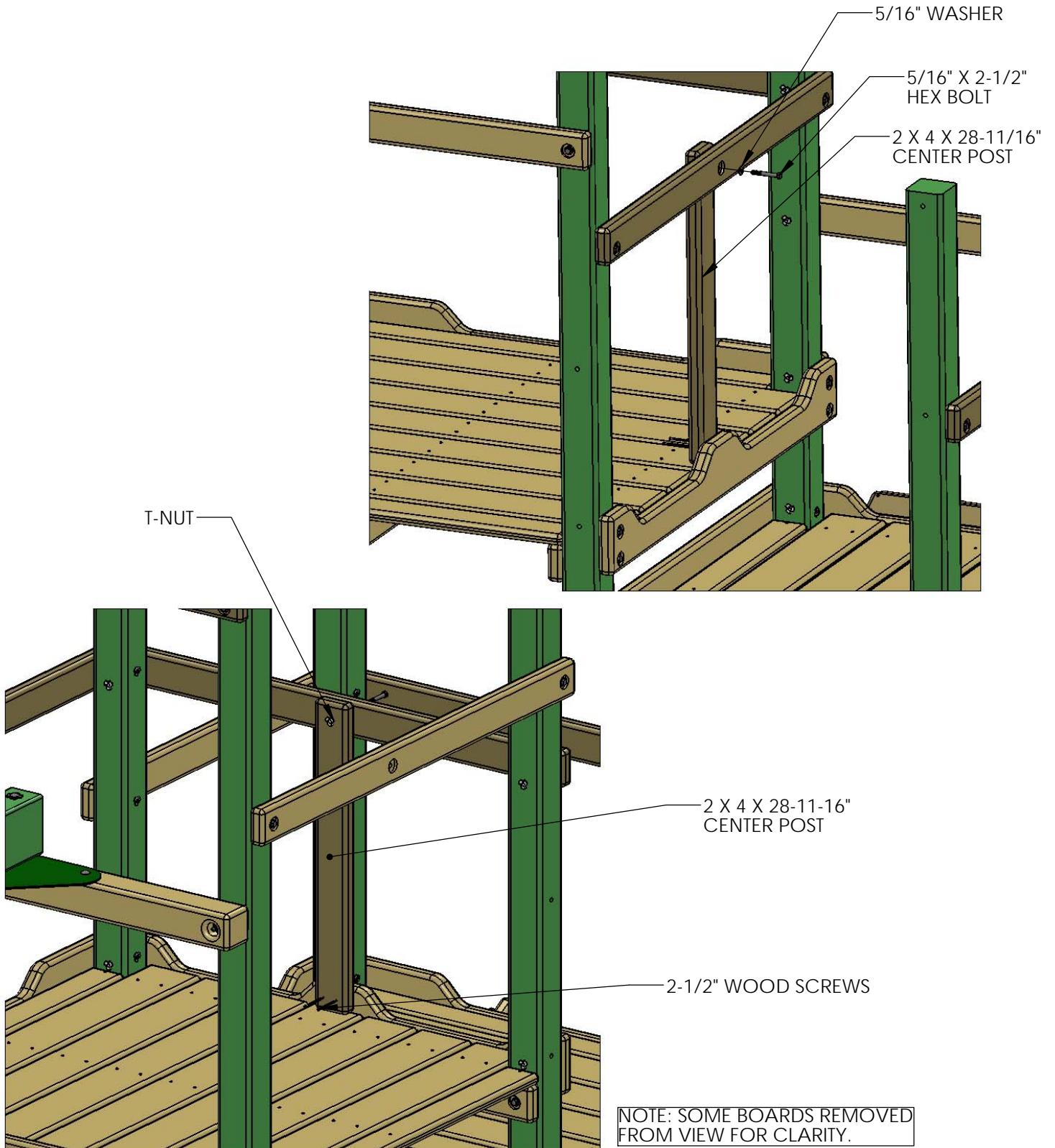

# STEP 44: DRILL HOLE FOR ANGLE BRACKET

1: MEASURE 27" UP FROM THE LOWER LEVEL DECK AND MAKE A HORIZONTAL LINE ON THE MIDDLE REAR POST.

2: PLACE THE HOLE OF THE SQUARE SIDE OF THE 90° BRACKET OVER THE LINE. THE POINTED SIDE OF THE BRACKET SHOULD BE FLUSH WITH THE OUTSIDE OF THE POST.

3: MARK THROUGH THE HOLE IN THE SQUARE SIDE OF THE BRACKET ONTO THE CORNER POST. DRILL A 9/64" HOLE 2" DEEP INTO THE POST. THEN SECURE THE SQUARE SIDE OF THE BRACKET TO THE POST WITH A 5/16" X 3-1/2" LAG SCREW AND 5/16" WASHER.

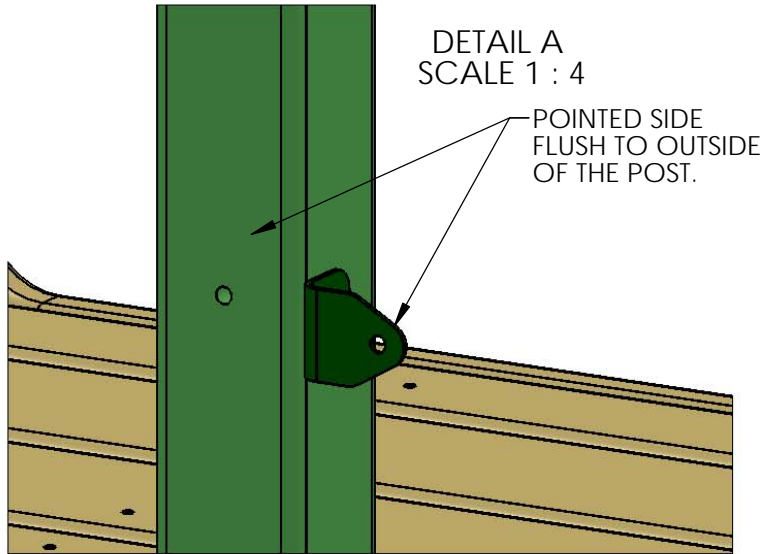

DRILL 9/64" HOLE AND THEN  
SECURE BRACKET TO POST WITH  
5/16" X 3-1/2" LAG SCREW  
AND 5/16" WASHER.

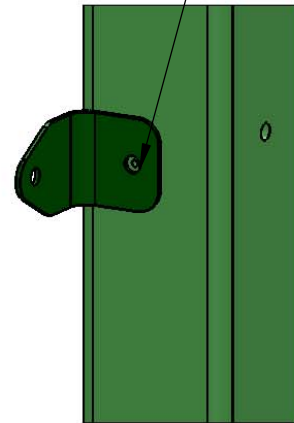

HOLE ON SQUARE SIDE OF BRACKET  
CENTERED ON THE 27" LINE ON THE POST.

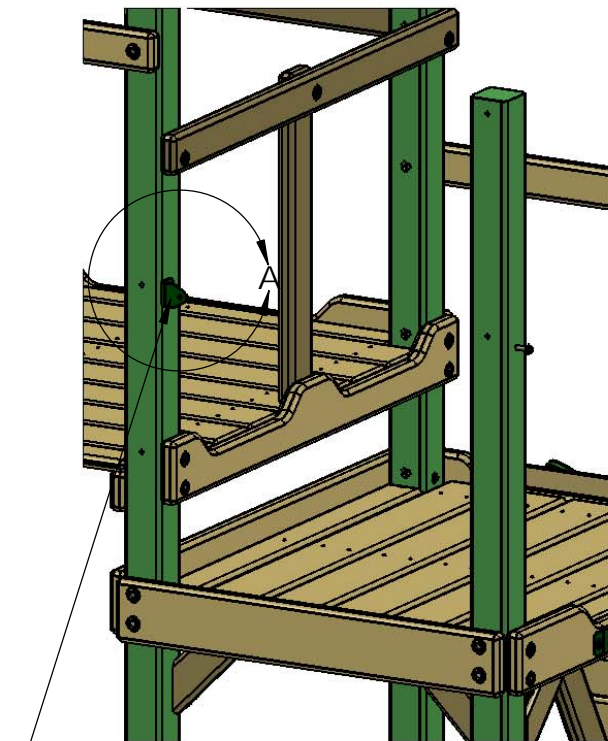

OUTSIDE VIEW OR REAR VIEW OF PLAYSET.

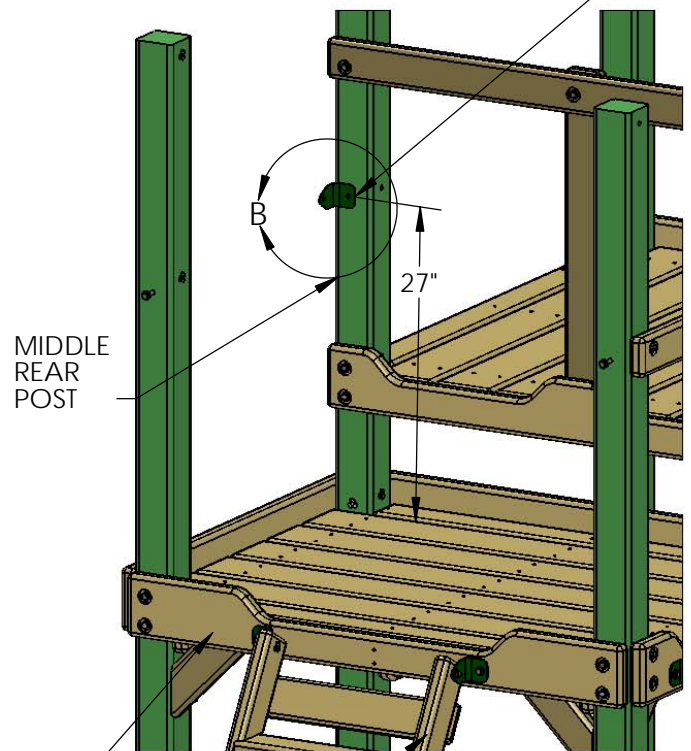

LEFT SIDE OF PLAY SET

LADDER

## STEP 45: TOP PANEL BOARD

1: PLACE THE 2 X 4 X 33" TOP PANEL BOARD (OFFSET UP) AGAINST THE REAR POSTS ON THE LOWER LEVEL.

2: SECURE THE HOLE IN THE BOARD TO THE PORCH REAR POST WITH A 5/16" X 4-1/2" HEX BOLT AND 5/16" WASHER.

3: LEVEL THE TOP PANEL BOARD TO THE DECK.

4: USE HOLE IN THE POINTED FLANGE OF THE 90° BRACKET AS A GUIDE TO DRILL A 3/8" HOLE THROUGH THE TOP PANEL BOARD.

5: HAMMER A T-NUT INTO THE HOLE YOU DRILLED IN THE TOP PANEL BOARD.

6: ATTACH THE TOP PANEL BOARD TO THE 90° BRACKET WITH A 5/16" X 1-1/2" HEX BOLT AND A 5/16" WASHER.

### TO AVOID SPLIT-OUT WHEN DRILLING THE HOLE:

**!!USE CAUTION SO YOU DO NOT HIT YOUR HAND!!  
PLACE A BACKER BOARD BEHIND HERE WHEN  
DRILLING HOLE.**

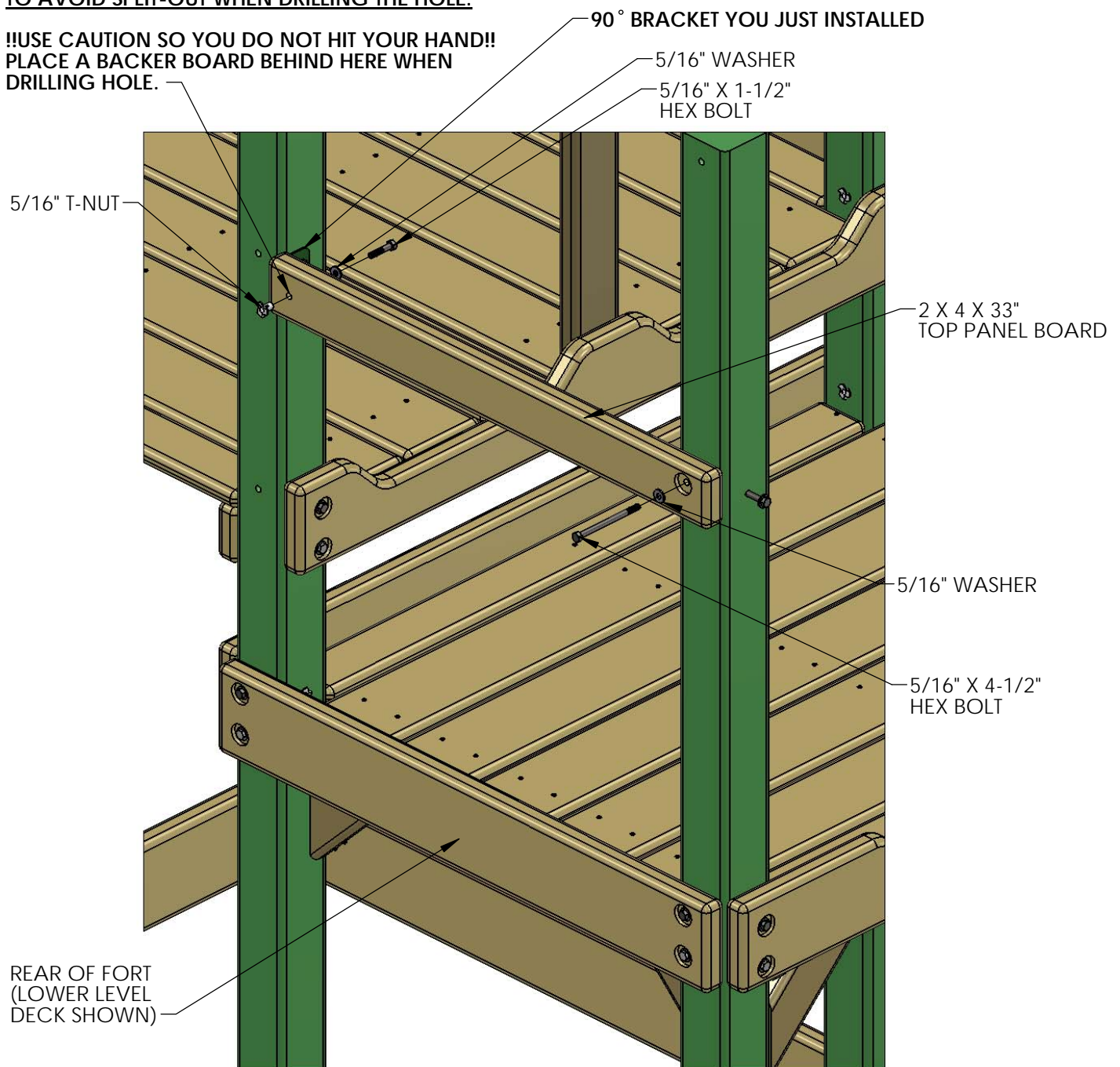



## STEP 46: PORCH PANEL SLATS

- 1: FIND NINE 5/4 X 3 X 28" PANEL SLATS.
- 2: INSTALL THE SLATS AT EQUAL LENGTHS. SEE DETAIL BELOW FOR MEASUREMENTS.
- 3: ATTACH THE PANEL SLATS TO THE FORT WITH 2" WOOD SCREWS IN THE PRE-DRILLED HOLES.

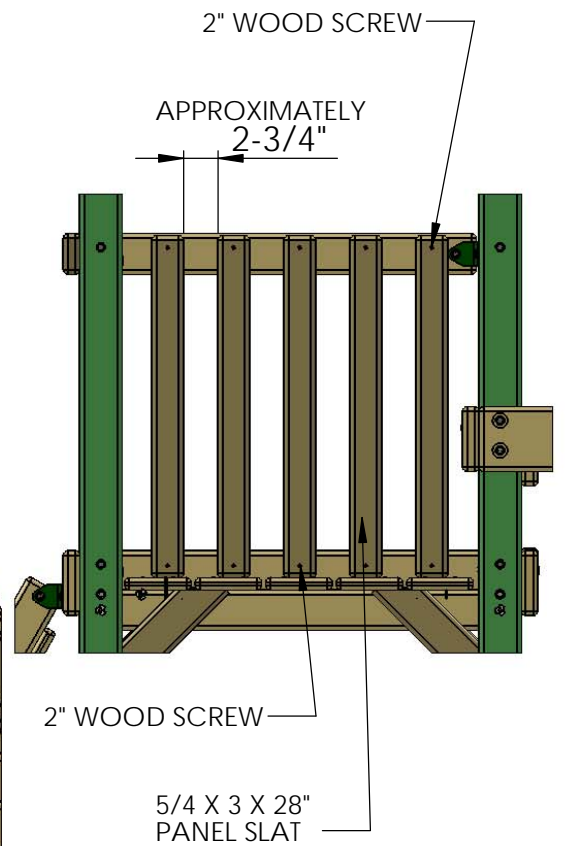
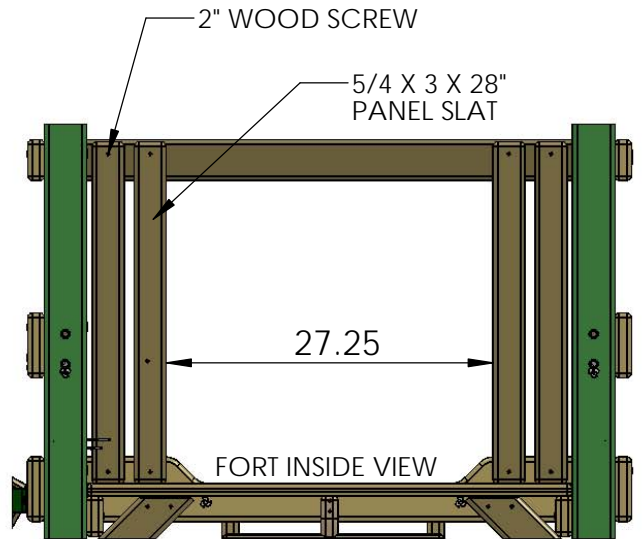

# STEP 47: WINDOW PANEL BOARDS

## SWING BEAM WALL:

FOR THIS WALL YOU SHOULD HAVE:

- \* TWO OF THE 5/4 X 6 X 58-1/2" WINDOW PANEL BOARD
- \* TWO OF THE 5/4 X 4 X 58-1/2" WINDOW PANEL BOARD
- \* FOUR OF THE 5/4 X 6 X 32" WINDOW UNDER
- \* FOUR OF THE 5/4 X 6 X 12-5/8" WINDOW ABOVE
- \* TWO OF THE 5/4 X 3 X 17" WINDOW STRINGER(ATTACH WITH 1-3/4" SCREWS)

1: USE A LEVEL AND A SQUARE TO PROPERLY INSTALL ALL THE WINDOW PANEL BOARDS.

2: FOLLOW THE DIAGRAM BELOW TO PROPERLY INSTALL THE WINDOW PANEL BOARDS, MAKE SURE YOU EQUALLY SPACE ALL THE BOARDS LEAVING A UNIFORM GAP IN BETWEEN THEM. USE 2" WOOD SCREWS TO FASTEN THE BOARDS THROUGH THE PRE DRILLED HOLES TO THE TOP, MIDDLE AND BOTTOM PANEL BOARD BEHIND THEM.

3: MAKE SURE YOU LEAVE APPROXIMATELY 11-1/2" X 14-1/2" OPENING FOR THE PLASTIC WINDOWS TO BE INSTALLED ON THE NEXT PAGE.

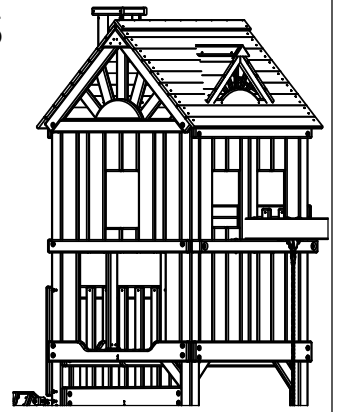

## STRAIGHT SLIDE WALL:

FOR THIS WALL YOU SHOULD HAVE:

- \* TWO OF THE 5/4 X 6 X 58-1/2" WINDOW PANEL BOARD
- \* TWO OF THE 5/4 X 4 X 33-1/4" WINDOW PANEL BOARD
- \* TWO OF THE 5/4 X 6 X 33-1/4" WINDOW PANEL BOARD
- \* TWO OF THE 5/4 X 6 X 12-5/8" WINDOW ABOVE
- \* TWO OF THE 5/4 X 6 X 6-1/2" WINDOW UNDER
- \* ONE OF THE 5/4 X 3 X 17" WINDOW STRINGER (ATTACH WITH 1-3/4" SCREWS)

1: FOLLOW THE DIAGRAM BELOW TO PROPERLY INSTALL THE WINDOW PANEL BOARDS, MAKE SURE YOU EQUALLY SPACE ALL THE BOARDS LEAVING A UNIFORM GAP IN BETWEEN THEM. USE 2" WOOD SCREWS TO FASTEN THE BOARDS THROUGH THE PRE DRILLED HOLES TO THE TOP, MIDDLE AND BOTTOM PANEL BOARD BEHIND THEM.

2: MAKE SURE YOU LEAVE APPROXIMATELY 11-1/2" X 14-1/2" OPENING FOR THE PLASTIC WINDOWS TO BE INSTALLED ON THE NEXT PAGE.

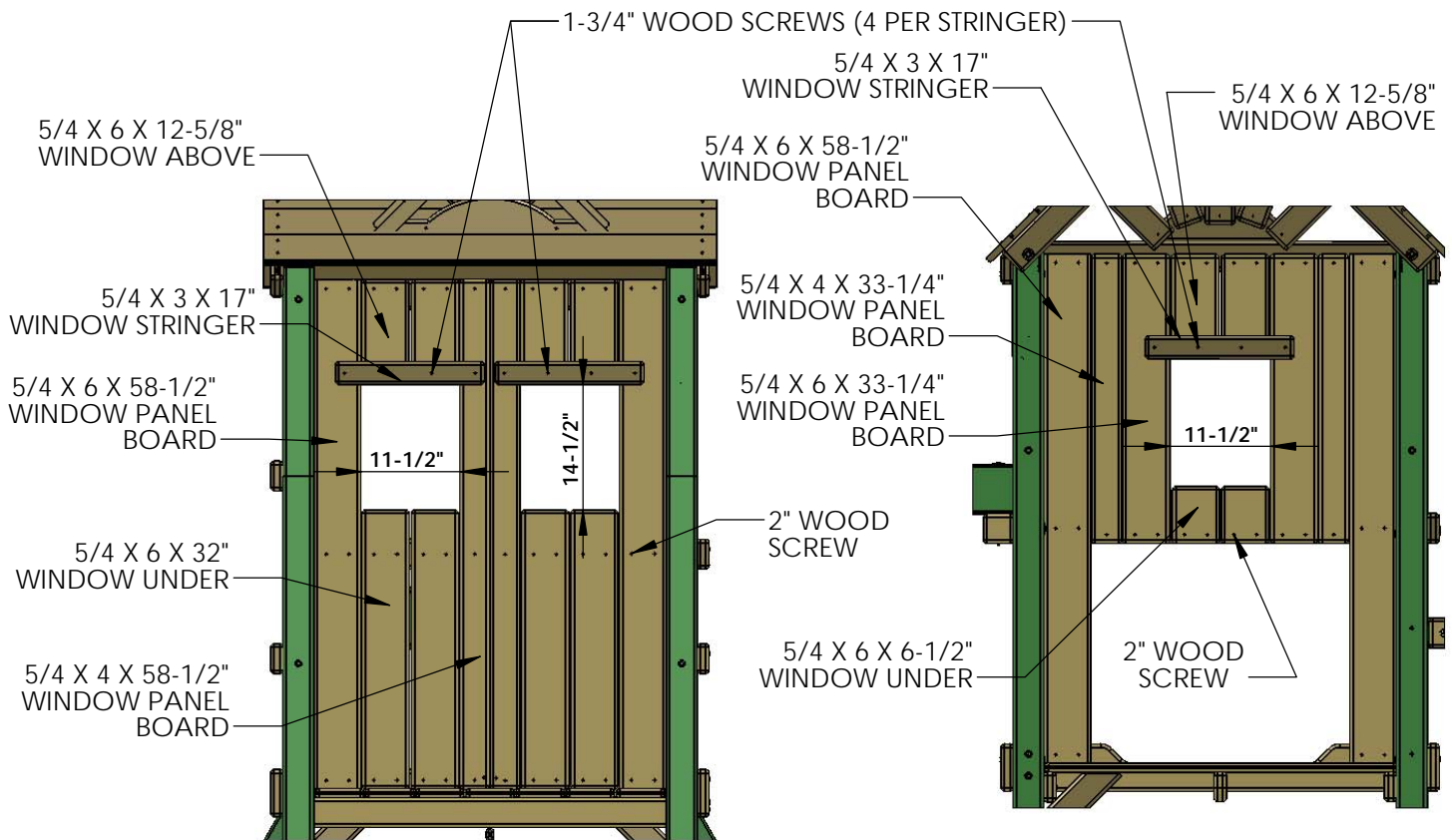

FORT INSIDE VIEW  
**SWING BEAM WALL**

FORT INSIDE VIEW  
**STRAIGHT SLIDE WALL**

## STEP 48: INSTALLING WINDOWS

1: FIND THREE PLASTIC WINDOWS. PLACE EACH WINDOW IN THE OPENING WITH THE 1" WIDE SECTION OF THE WINDOW FRAME AT THE TOP. ATTACH EACH WINDOW WITH FOUR 1-1/2" WOOD SCREWS.

2: FIND THREE WINDOW CROWNS AND PLACE EACH WINDOW CROWN ABOVE THE PLASTIC WINDOWS, MAKE SURE THE ENDS OF THE CROWN ARE FLUSH WITH THE ENDS OF THE PLASTIC WINDOW. ATTACH EACH WINDOW CROWN WITH TWO 1-1/4" WOOD SCREWS.

TOP OF THE FRAME IS 1"

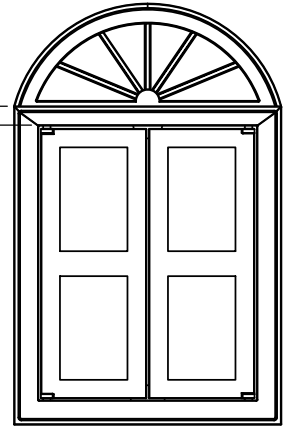

WINDOW CROWN

PLASTIC WINDOW

WINDOW CROWN

PLASTIC WINDOW

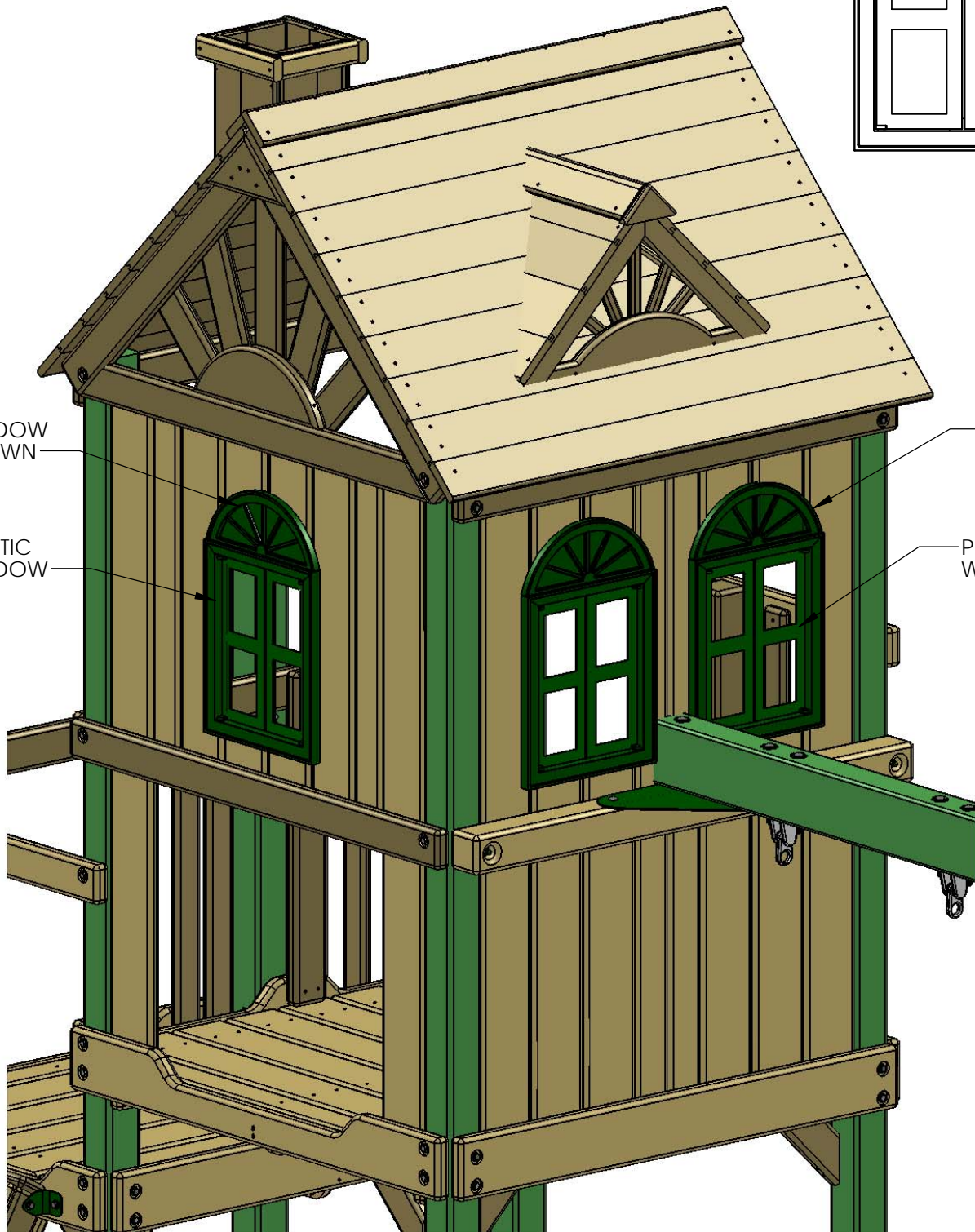



## STEP 49: PORCH ROOF SUPPORT

1: ATTACH THE 2 X 4 X 44" PORCH ROOF SUPPORT RIGHT AND PORCH ROOF SUPPORT LEFT TO THE FORT WITH 5/16 X 4-1/2" HEX BOLTS THROUGH THE HOLE (OFFSET DOWN) INTO THE T-NUT INSTALLED IN THE CORNER POST.

2: THE ANGLED END SHOULD BE POINTING TO THE MAIN ROOF, THE ANGLE END MUST BE FLUSH TO THE OUTSIDE EDGE OF THE MIDDLE CORNER POST. INSERT A 5/16 X 3-1/2" LAG SCREW AND 5/16" WASHER THROUGH THE ANGLED END HOLE IN TO THE MIDDLE CORNER POST. THERE WILL NOT BE ANY PREDRILLED HOLES IN THE MIDDLE CORNER POST FOR THE LAG SCREWS.

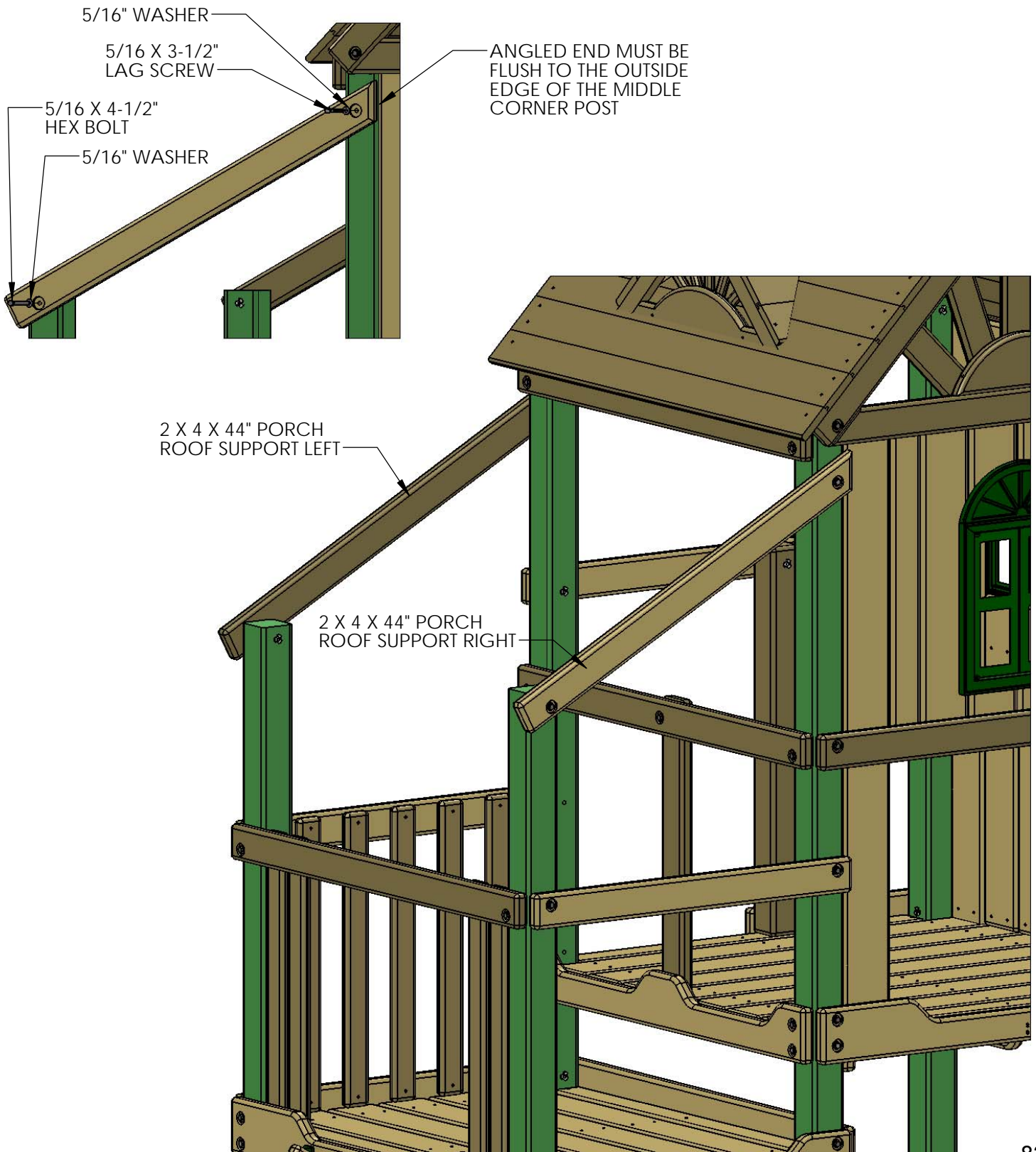

## STEP 50: PORCH ROOF STARTER

1: INSTALL THE 1 X 4 X 52" ROOF STARTER AT THE TOP END OF THE PORCH ROOF SUPPORTS, MAKE SURE THE TOP EDGE OF THE ROOF STARTER IS TOUCHING THE MIDDLE CORNER POSTS AND CENTER IT BETWEEN THE ROOF SUPPORTS LEAVING AN EQUAL SPACE ON BOTH ENDS. SECURE USING TWO 1-1/2" WOOD SCREWS PER SIDE THROUGH THE PRE DRILLED HOLES IN TO THE ROOF SUPPORTS. THE HEAD OF THE SCREW MUST BE FLUSH TO THE ROOF BOARD, DO NOT OVER TIGHTEN.

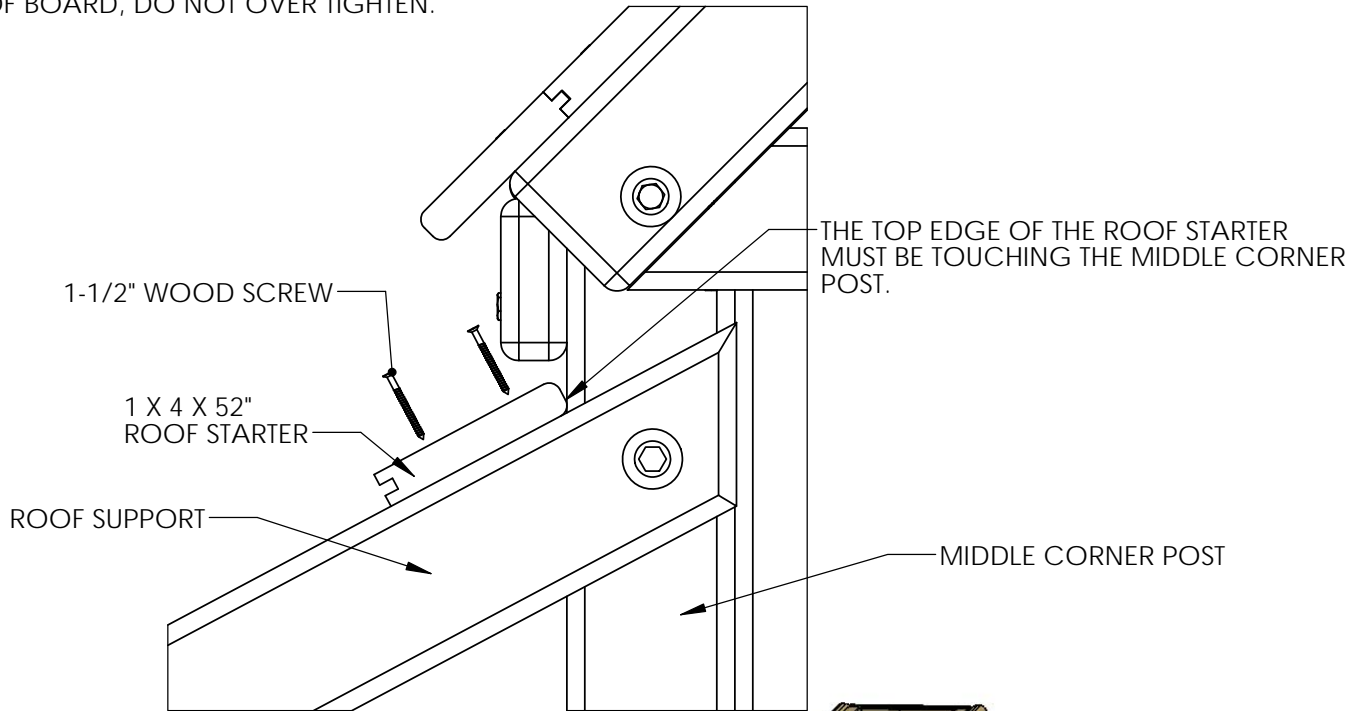

## STEP 51: PORCH ROOF BOARDS

1: PLACE THE 1 X 5 X 52" ROOF BOARDS ON TOP OF THE ROOF SUPPORTS. FITTING THE TONGUE INTO THE GROOVE END OF THE ROOF STARTER.

2: FASTEN THE ROOF BOARDS TO THE ROOF SUPPORTS WITH 1-1/2" WOOD SCREWS.

3: PLACE A 1 X 4 X 52" ROOF FINISHER AT THE END OF THE ROOF ASSEMBLY. AND FASTEN WITH 1-1/2" WOOD SCREWS.

4: PLACE THE 5/4 X 4 X 50-1/4" ROOF END CAP AT THE END OF THE ROOF SUPPORTS UNDERNEATH THE ROOF FINISHER, AND FASTEN WITH TWO 2" WOOD SCREWS ON EACH END.

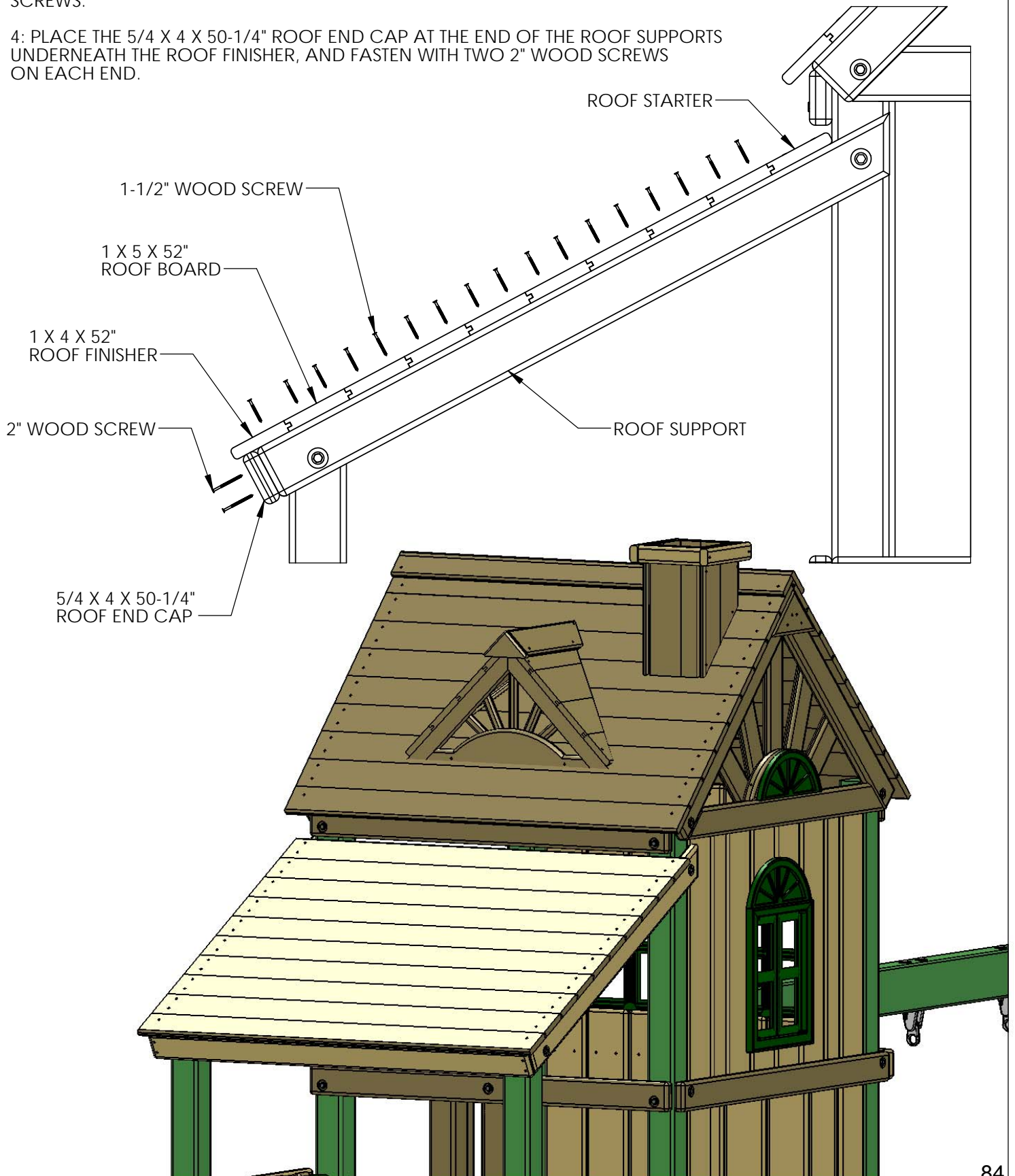

## STEP 52: PICNIC TABLE SIDES

1: LOCATE TWO 2 X 4 X 14-3/4" PT TOP SUPPORT, TWO 2 X 4 X 27-1/2" PT SEAT SUPPORTS AND TWO 2 X 4 X 32-1/2" PT LEGS AND TWO 5/4 X 3 X 13-1/4" PICNIC TABLE SLATS.

2: FOR THE LEFT SIDE ASSEMBLY, PLACE A 2 X 4 X 14-3/4" PT TOP SUPPORT AND A 2 X 4 X 27-1/2" PT SEAT SUPPORT PARALLEL TO ONE ANOTHER. PLACE A 2 X 4 X 32-1/2" PT LEG ON TOP AT THE 7-1/2" DIMENSION. THE TOP OF THE PT LEG SHOULD BE FLUSH TO THE TOP OF THE PT TOP SUPPORT, ATTACH THE PT LEG TO THE SUPPORTS WITH 2-1/2" WOOD SCREWS.

3: FOR THE RIGHT SIDE ASSEMBLY, PLACE A 2 X 4 X 14-3/4" PT TOP SUPPORT AND A 2 X 4 X 27-1/2" PT SEAT SUPPORT PARALLEL TO ONE ANOTHER. PLACE A 2 X 4 X 32-1/2" PT LEG ON TOP AT THE 7-1/2" DIMENSION. THE TOP OF THE PT LEG SHOULD BE FLUSH TO THE TOP OF THE PT TOP SUPPORT. ATTACH THE PT LEG TO THE SUPPORTS WITH #8 X 2-1/2" WOOD SCREWS.

4: PLACE THE PICNIC TABLE SLAT NEXT TO THE PICNIC TABLE LEG FOR EACH ASSEMBLY BELOW. LEAVE A 3/16" GAP BETWEEN THE TOP OF THE SLAT AND THE LEG. USE THE 6-15/16" DIMENSION TO LOCATE THE BOTTOM END OF THE SLAT. FASTEN THE PICNIC TABLE SLAT TO THE SUPPORTS WITH TWO #8 X 2" WOOD SCREWS.

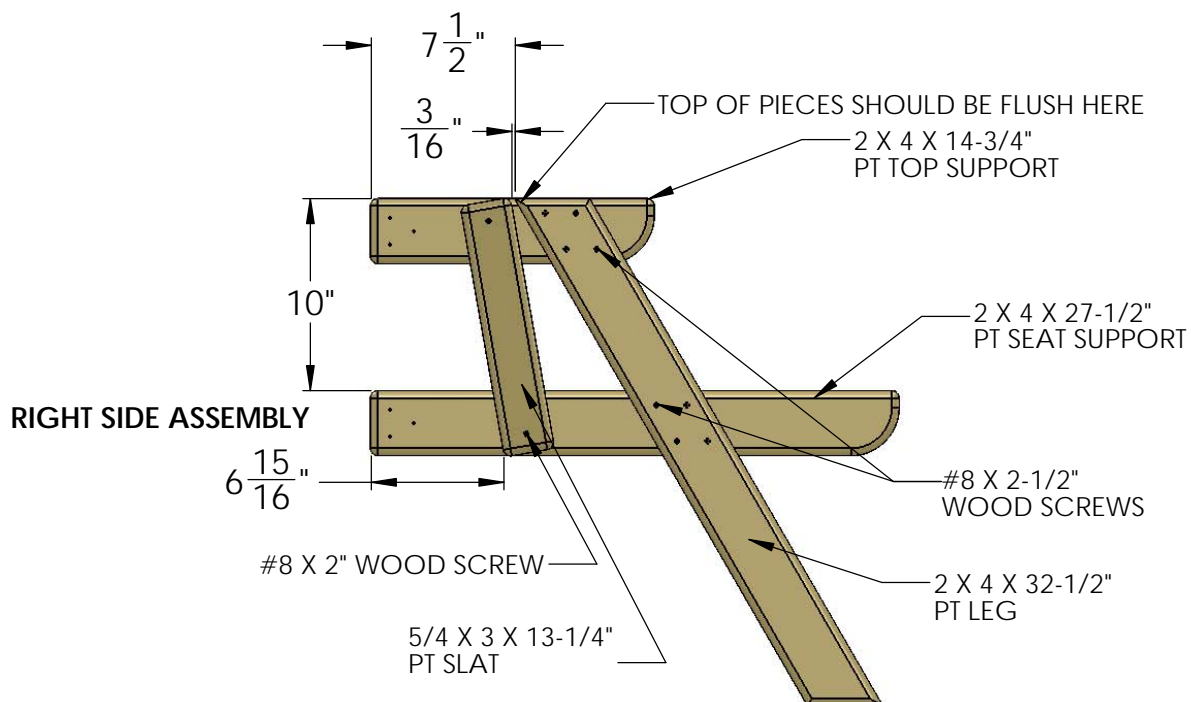
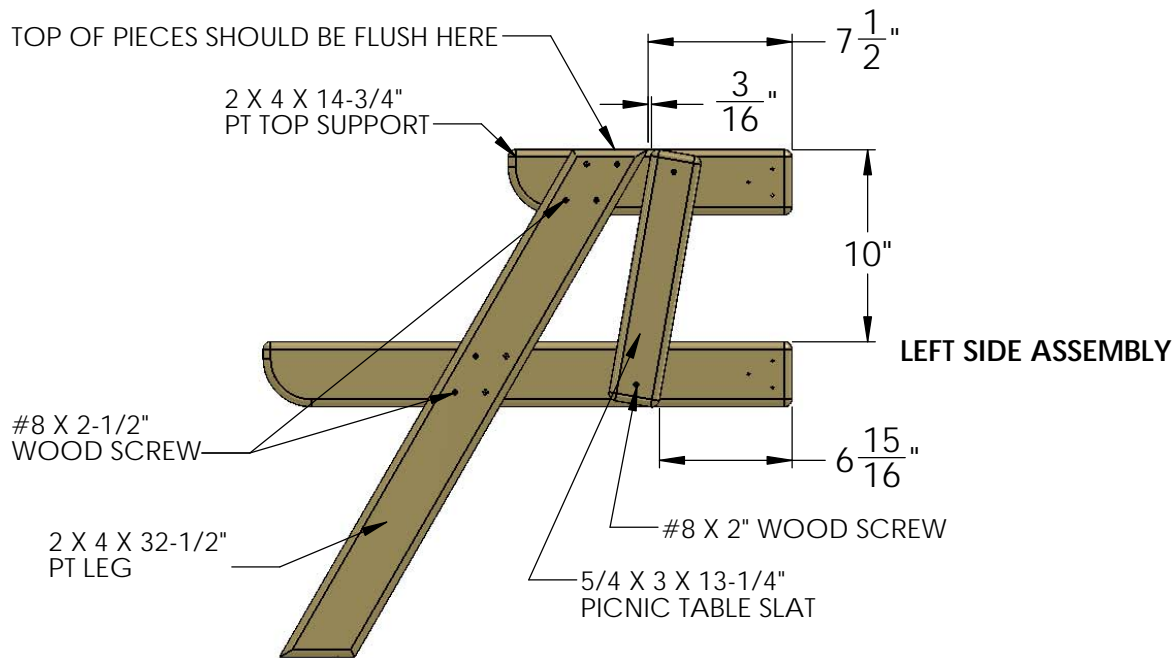



## STEP 53: PICNIC TABLE SIDES TO FORT

- 1: MEASURE UP 26-3/8" FROM THE BOTTOM OF THE CORNER POSTS ON THE RIGHT SIDE OF THE PLAY SET UNDERNEATH THE DECK. MAKE MARKS ON THE INSIDE OF THE CORNER POSTS WITH A PEN OR PENCIL AT 26-3/8"
- 2: PLACE THE TOP OF THE RIGHT SIDE ASSEMBLY FLUSH TO THE MARK ON THE CORNER POST. ATTACH THE RIGHT SIDE ASSEMBLY TO THE INSIDE OF THE CORNER POST WITH 3" WOOD SCREWS.
- 3: PLACE THE TOP OF THE LEFT SIDE ASSEMBLY FLUSH TO THE MARK ON THE CORNER POST. ATTACH THE LEFT SIDE ASSEMBLY TO THE INSIDE OF THE CORNER POST WITH 3" WOOD SCREWS.



## STEP 54: PICNIC TABLE TOP AND SEAT BOARDS

- 1: LOCATE FOUR 5/4 X 6 X 43" PT TOP AND SEAT BOARDS.
- 2: CENTER THE HOLES IN THE BOARDS OVER THE TOP OR SEAT SUPPORTS.
- 3: FASTEN THE PT TOP AND SEAT SUPPORTS TO THE TOP OR SEAT SUPPORTS WITH 2" WOOD SCREWS.

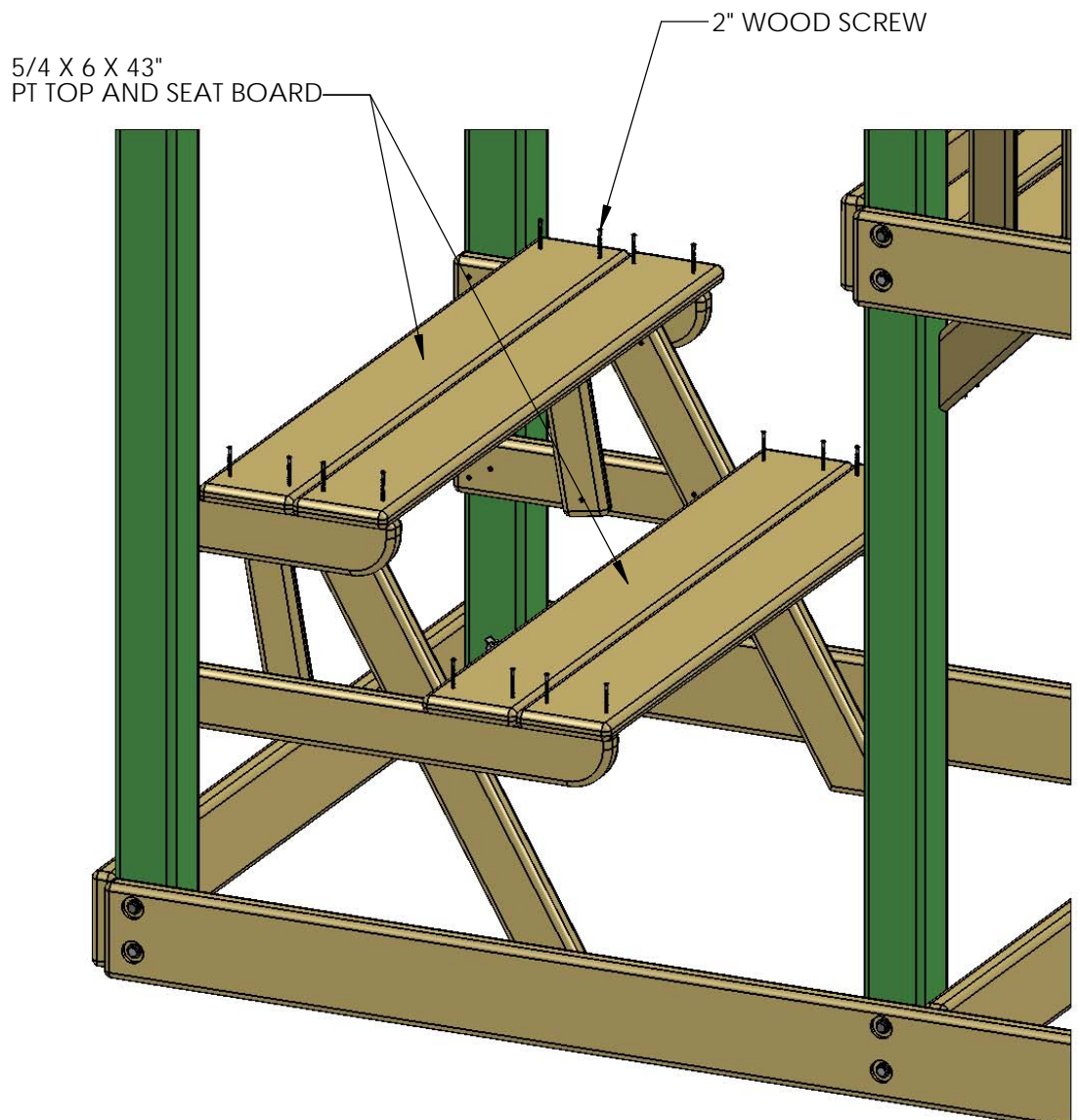



## STEP 55: PORCH SAFETY BAR

1: PLACE A 2 X 4 X 47-1/2" SAFETY BAR (TOP PANEL BOARD) IN BETWEEN THE ENTRANCE BOARD AND THE DECK, AND SPACE EVENLY. THE HOLES ARE OFFSET TO THE TOP.

2: FASTEN USING TWO 5/16 X 3-1/2" LAG SCREWS THROUGH THE SAFETY BAR HOLES INTO THE CORNER POSTS.

NOTE: THERE WILL NOT BE ANY PREDRILLED HOLES IN THE CORNER POSTS FOR LAG SCREWS.

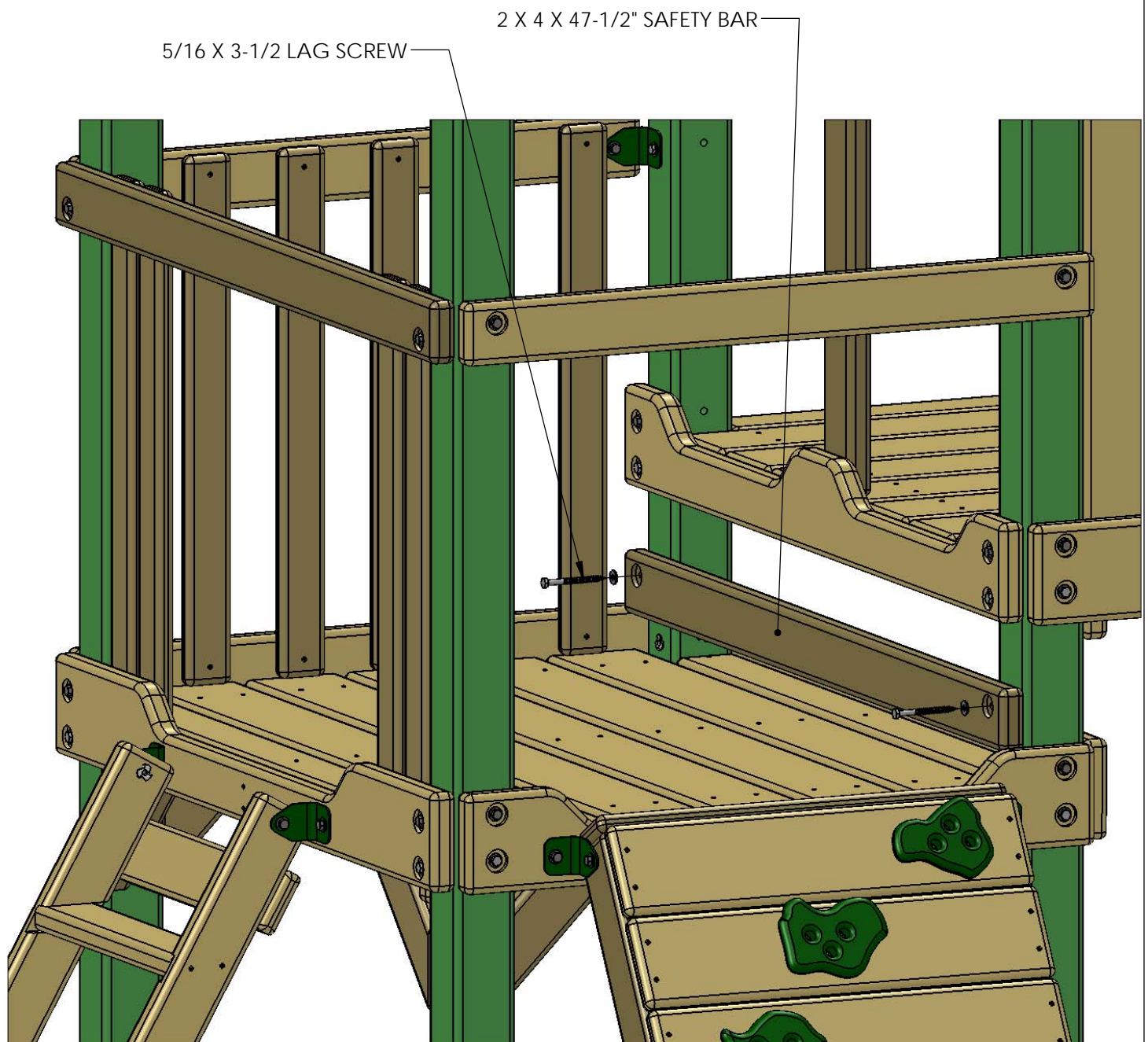

## STEP 56: FORT SAFETY BAR

1: MOUNT THE 2 X 4 X 47-1/2" SAFETY BAR (TOP PANEL BOARD) FROM THE OUTSIDE OF THE FORT ABOVE THE PICNIC TABLE, 40-1/2" FROM THE BOTTOM OF THE SAND BOX BOARD TO THE TOP OF THE SAFETY BAR. HOLES SHOULD BE OFFSET DOWN.

2: MAKE SURE BOTH ENDS OF THE SAFETY BAR ARE AT THE SAME HEIGHT, AND ATTACH USING 5/16 X 3-1/2" HEX BOLTS AND 5/16" WASHERS THROUGH THE HOLES INTO THE CORNER POSTS.

NOTE: THERE WILL NOT BE ANY PREDRILLED HOLES IN THE CORNER POSTS FOR LAG SCREWS.

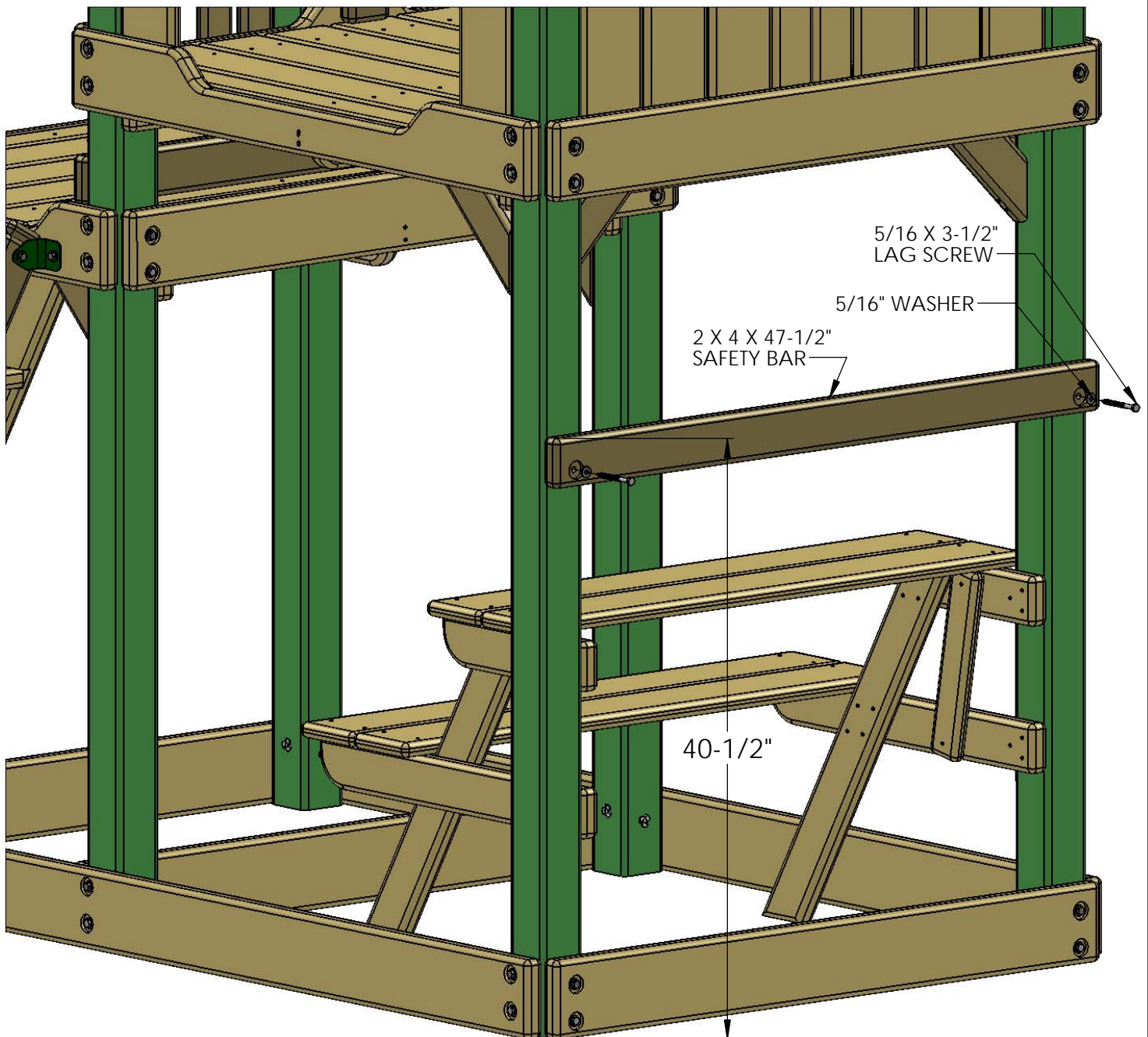

# STEP 57: TOY CHEST

FOLLOW THE TOY CHEST INSTRUCTIONS TO ASSEMBLE IT.





## STEP 58: MOUNTING THE SLIDE

1: PLACE THE SLIDE IN THE OPENING AT THE FRONT OF THE PLAY SET NEXT TO THE ROCK WALL.

2: THE FLARED END OF THE SLIDE WILL REST ON TOP OF THE SLIDE EXIT BOARD. THE FLAT AREA OF THE SLIDE WITH FOUR INDENTATIONS WILL LIE ON TOP OF THE DECK BOARDS.

3: ATTACH THE SLIDE TO THE DECK BOARDS WITH FOUR 1-1/4" PAN HEAD SCREWS.

**\*\*DO NOT OVER TIGHTEN\*\***

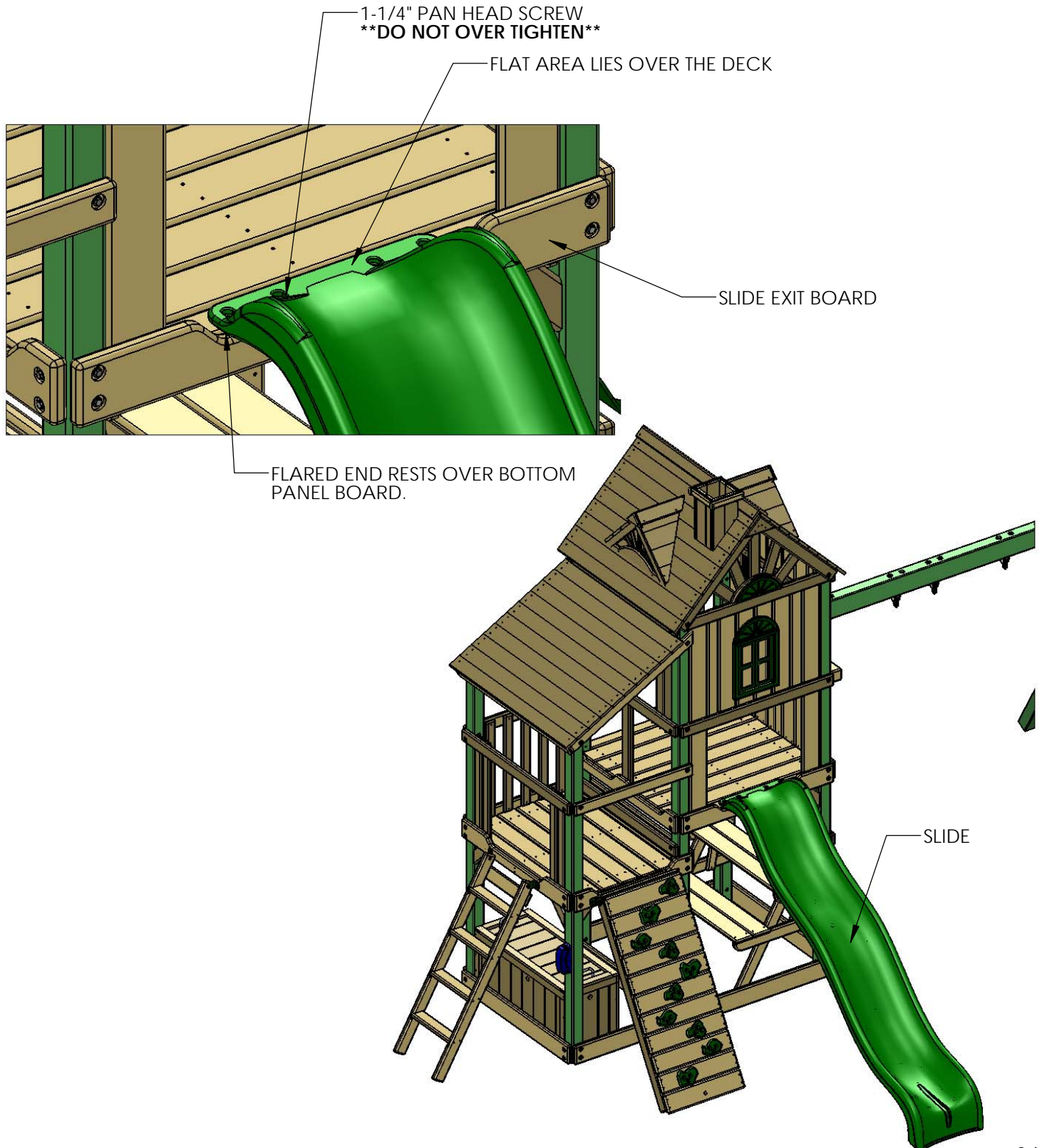

## STEP 59: ATTACHING THE EXTREME TUBE SLIDE

1: ASSEMBLE THE EXTREME TUBE SLIDE ACCORDING TO THE INSTRUCTIONS PROVIDED. SEE BELOW FOR PLACEMENT OF YOUR SLIDE.

2: ONCE IN PLACE, TIGHTEN ALL HARDWARE ON SLIDE.

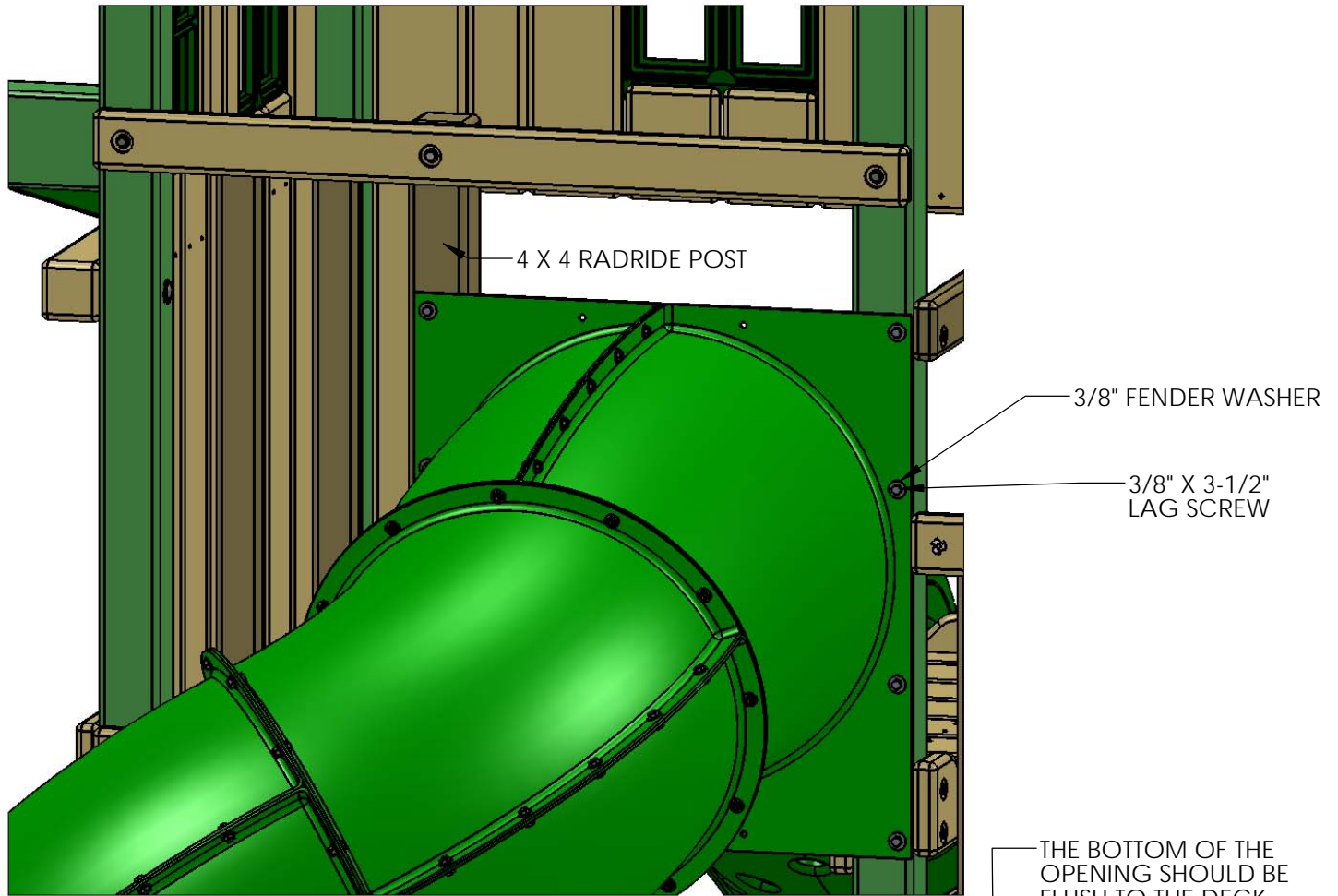

4 X 4 RADRIDE POST

3/8" FENDER WASHER

3/8" X 3-1/2" LAG SCREW

THE FLANGE OF THE SLIDE GOES IN BETWEEN THE 2 X 6 BOARD AND THE 4 X 4 POST

INSERT A 5/16" X 3-1/2" LAG SCREW AND 5/16" WASHER IN THIS HOLE.

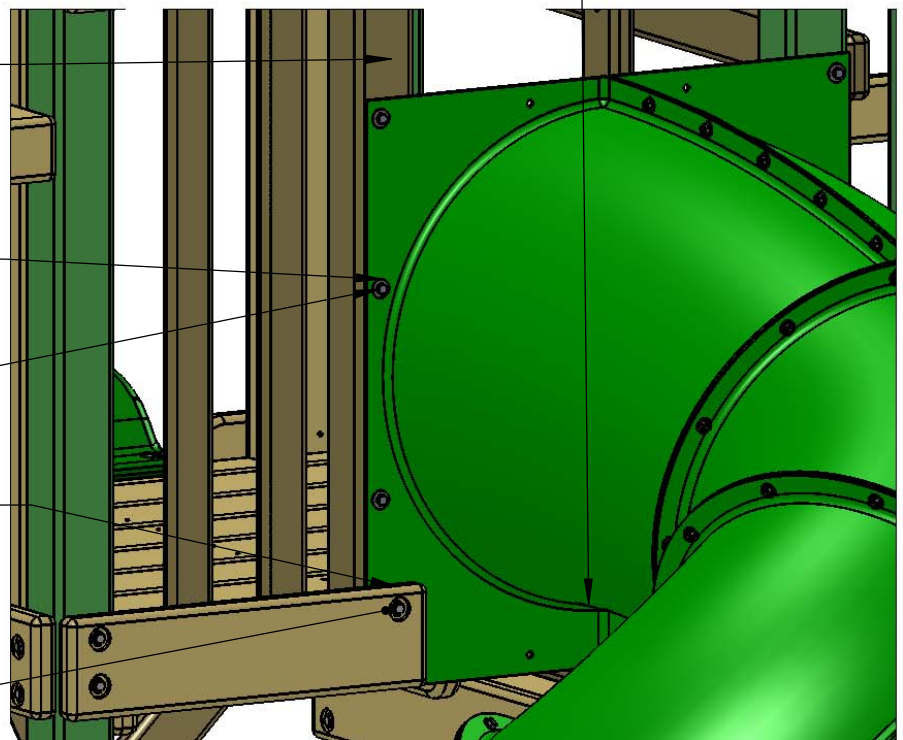

## STEP 60: SLIDE HEADER BOARD

1: MOUNT THE 2 X 4 X 29-3/4" SLIDE HEADER BOARD ABOVE THE EXTREME SLIDE IN BETWEEN THE FLANGE EDGE AND THE TOP PANEL BOARD, SPACE EVENLY. MAKE SURE THE ENDS OF THE HEADER BOARD ARE FLUSH TO THE 4 X 4 POSTS.

2: FASTEN USING TWO 5/16 X 3-1/2" LAG SCREWS AND 5/16" WASHERS.

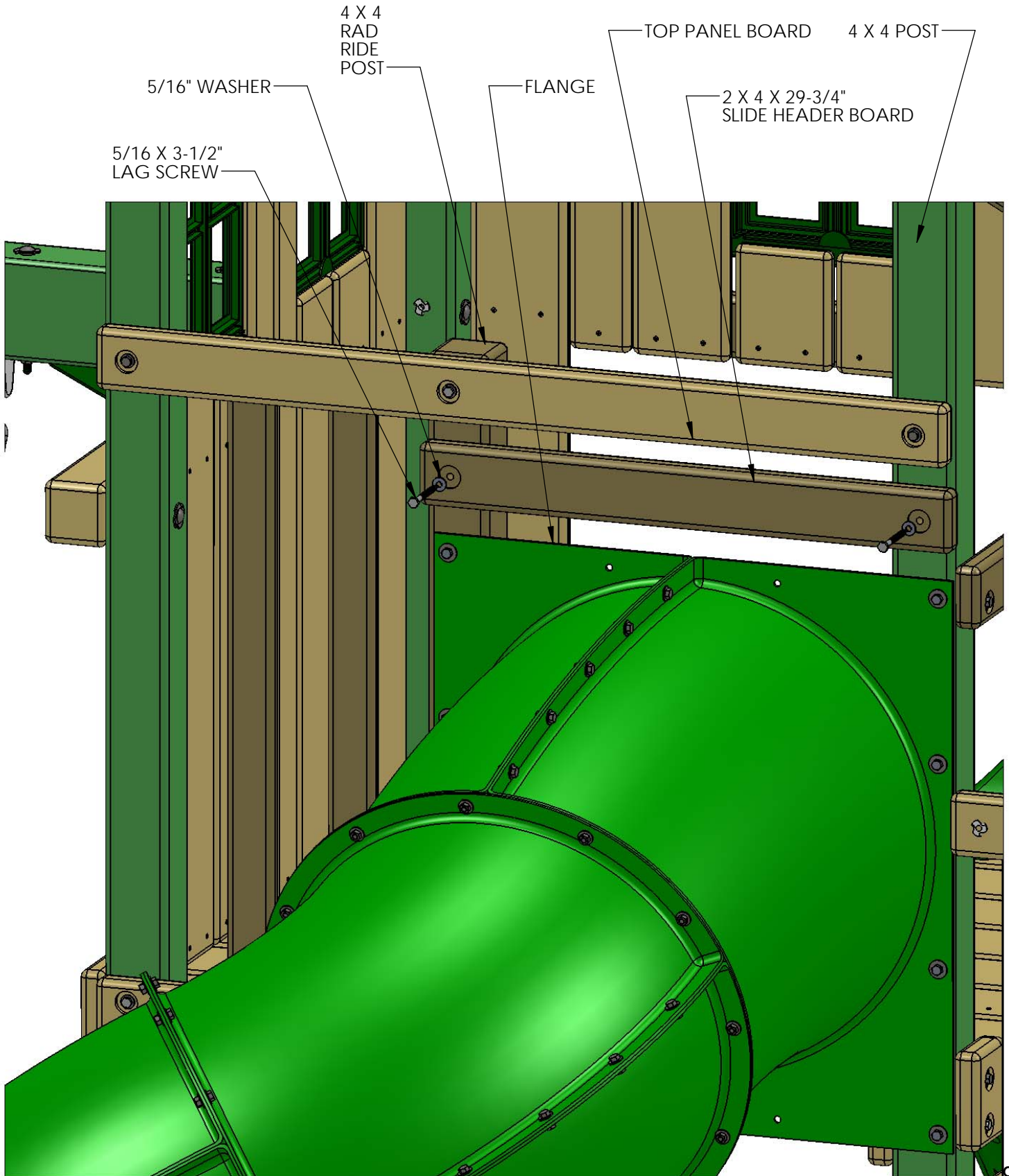



# STEP 61: TIC TAC TOE INSTALLATION

- 1: ASSEMBLE THE TIC TAC TOE PANEL ACCORDING TO THE INSTRUCTIONS IN THE BOX. **IGNORE** STEP 6 & STEP 7 IN THE INSTRUCTIONS.
- 2: ATTACH THE TWO 1-3/8 X 1-5/8 X 10-5/8"L TIC-TAC-TOE BOARDS TO THE GREEN PLASTIC BRACKETS WITH THE 1" PHILIPS HEAD SCREWS PROVIDED IN THE TIC-TAC-TOE BOX. **IMPORTANT:** MAKE SURE THE TIC-TAC-TOE BOARDS ARE MOUNTED TO THE GREEN BRACKETS AS SHOWN BELOW.
- 3: CENTER THE UNIT ON THE WINDOW PANEL BOARDS ON THE DOUBLE WINDOW WALL SIDE OF THE FORT.
- 4: MOUNT THE LOWER TIC-TAC-TOE BOARD 4" ABOVE THE DECK. ATTACH THE TIC-TAC-TOE BOARDS TO THE WALL BOARDS FROM THE OUTSIDE OF THE FORT WITH 2" WOOD SCREWS.

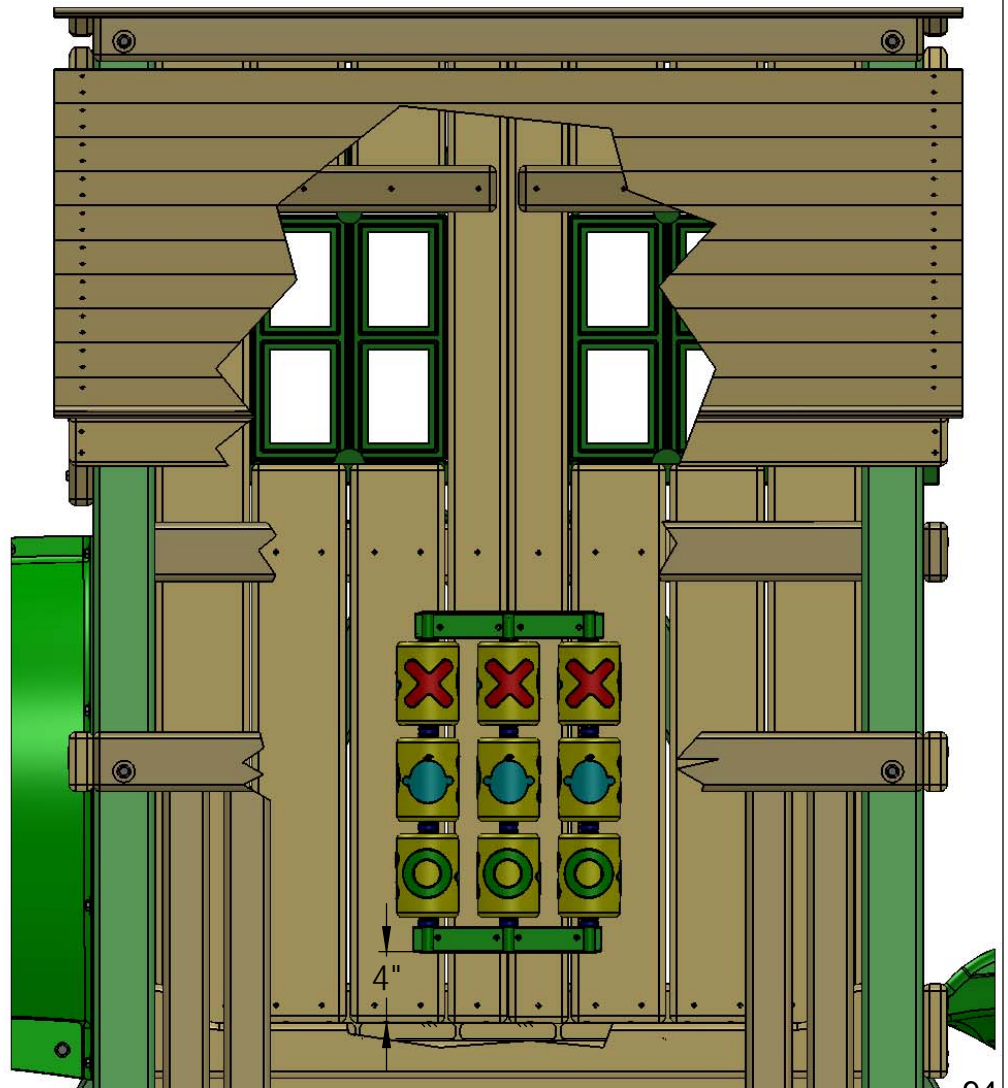
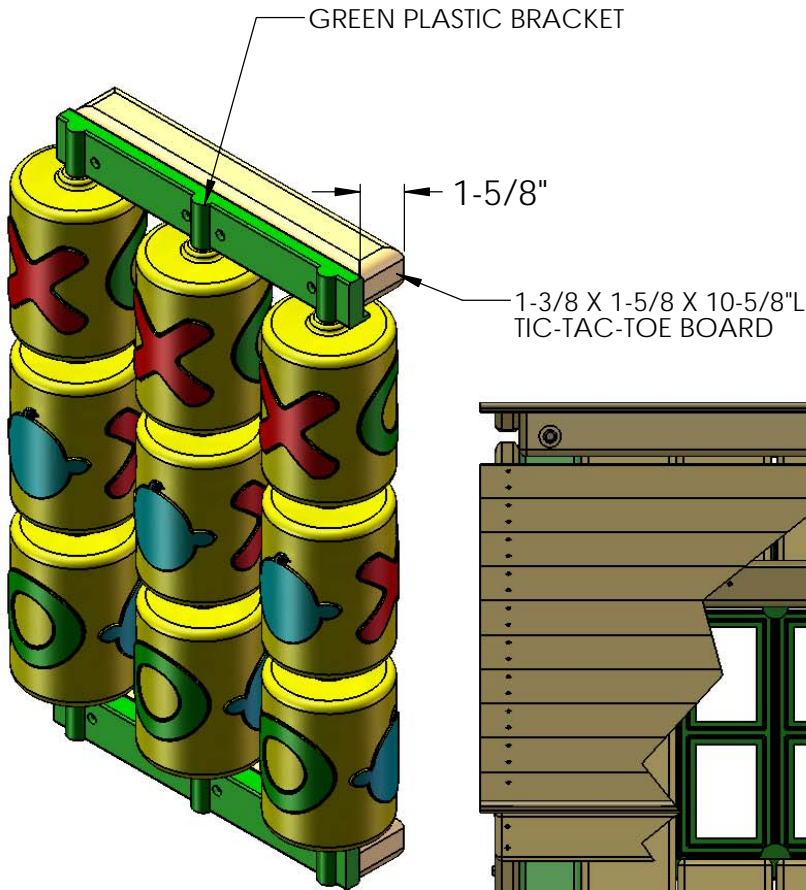

## STEP 62: BINOCULARS

1: ATTACH THE BINOCULAR BASE TO THE TOP OF THE RADRIDE POST ON YOUR PLAY SET.  
FASTEN WITH ONE 5/16" X 1-1/4" LAG SCREW AND ONE 8mm WASHER INCLUDED WITH THE BINOCULARS.

2: PLACE THE BOTTOM SIDE OF THE BINOCULARS WITH THE HOLE IN IT INSIDE THE BINOCULARS BASE.  
LINE UP THE HOLES IN THE BINOCULAR BASE WITH THE HOLE ON THE BOTTOM SIDE OF THE BINOCULARS.

3: SLIDE THE 8mm DIAMETER X 106 mm LENGTH PIVOT ROD THROUGH THE HOLES.

4: FASTEN ONE 8mm ACORN NUT AND ONE 8mm WASHER ON EACH END OF THE PIVOT ROD.

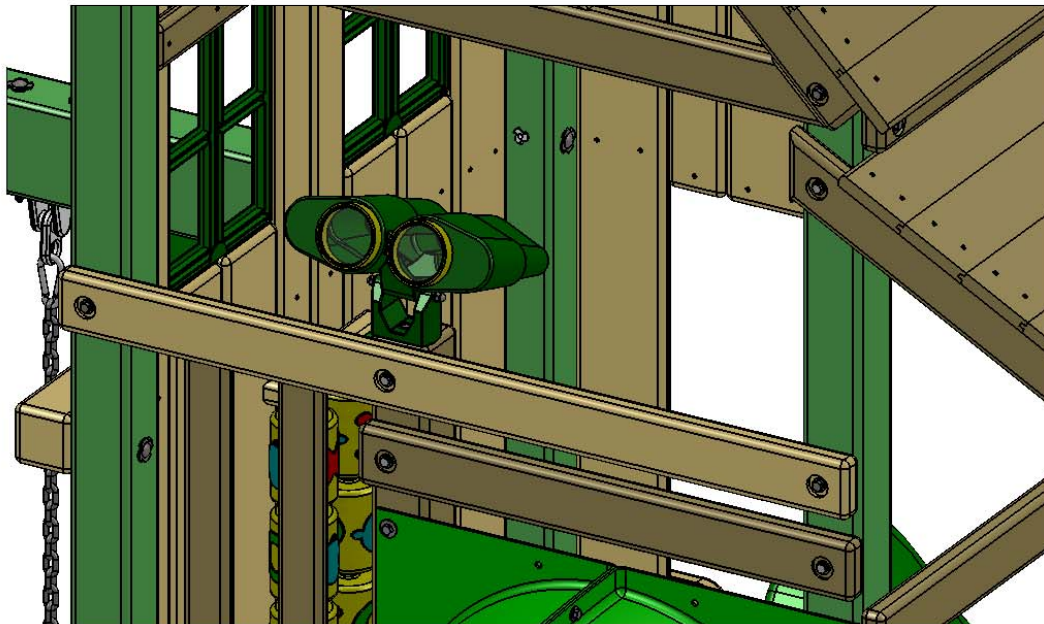
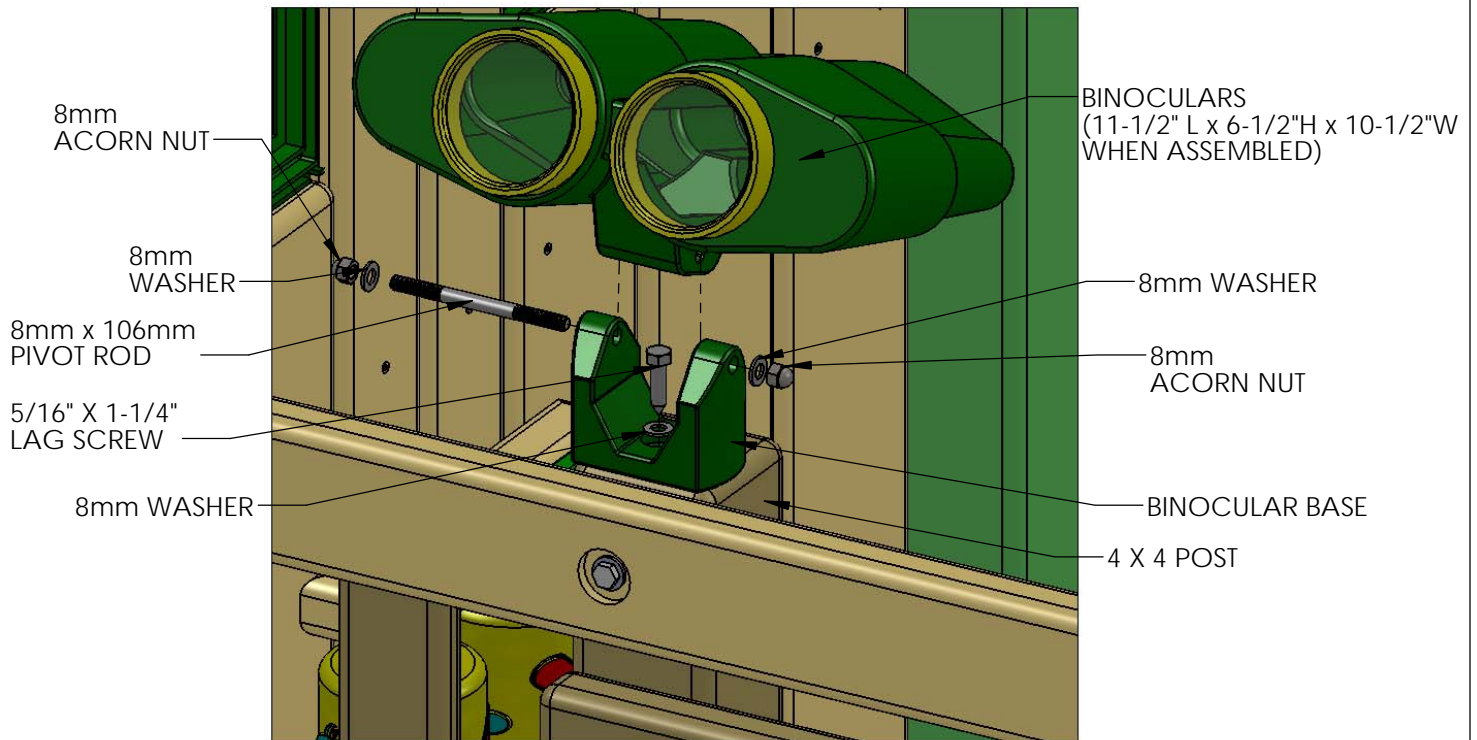

## STEP 63: TELESCOPE

1: WITH THE 1-1/4" WOOD SCREWS PROVIDED IN THE TELESCOPE BAG, FASTEN ONE OF THE SQUARE TELESCOPE BRACKETS TO THE BACK OF THE TOP PANEL BOARD.

2: PLACE THE TELESCOPE STAND AND TELESCOPE INTO THE SLOT OF THE TELESCOPE BRACKET.

3: FASTEN THE REMAINING TELESCOPE BRACKET TO THE OPPOSITE SIDE THAT THE FIRST TELESCOPE BRACKET WAS INSTALLED ON WITH 1-1/4" WOOD SCREWS.

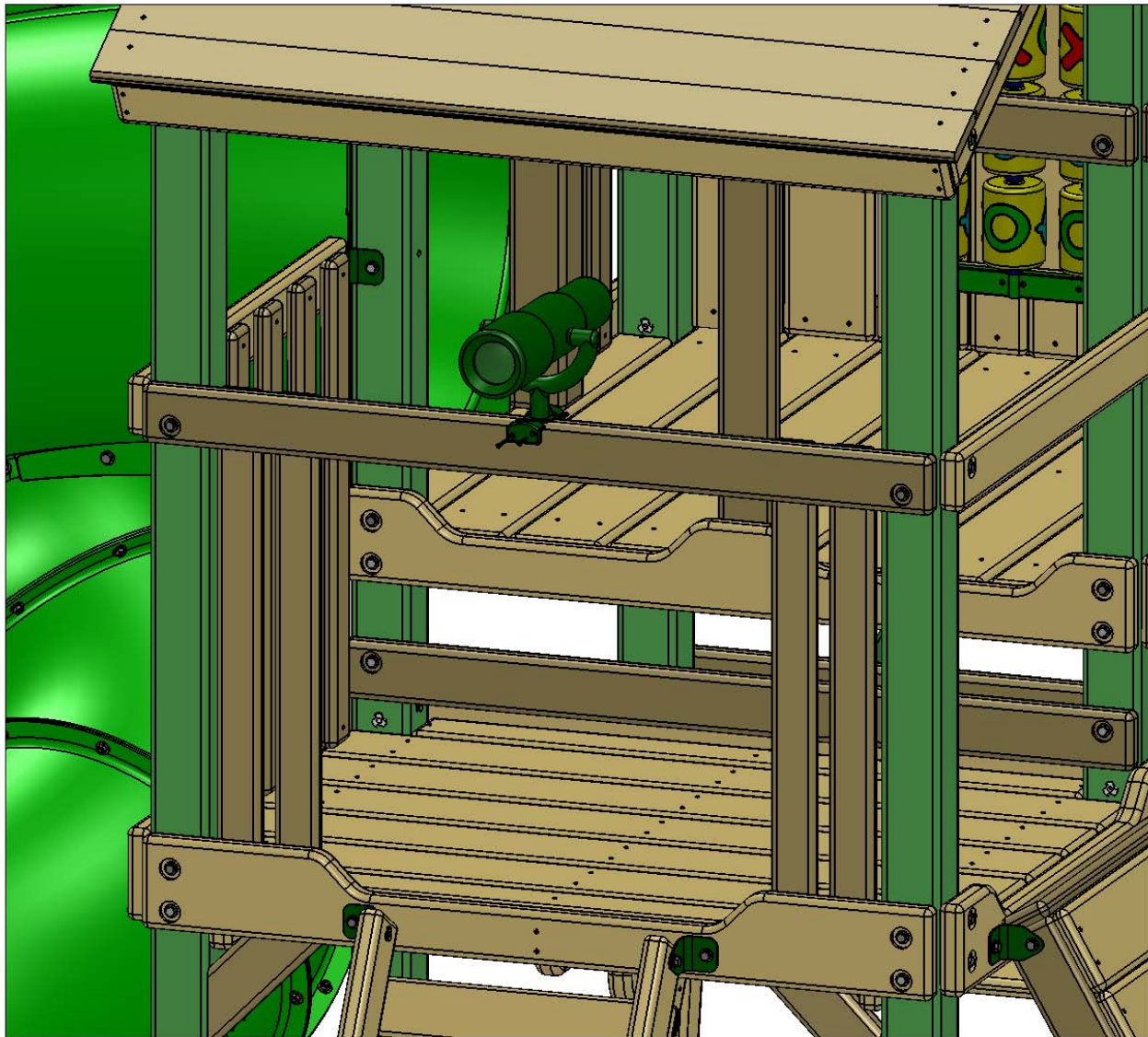
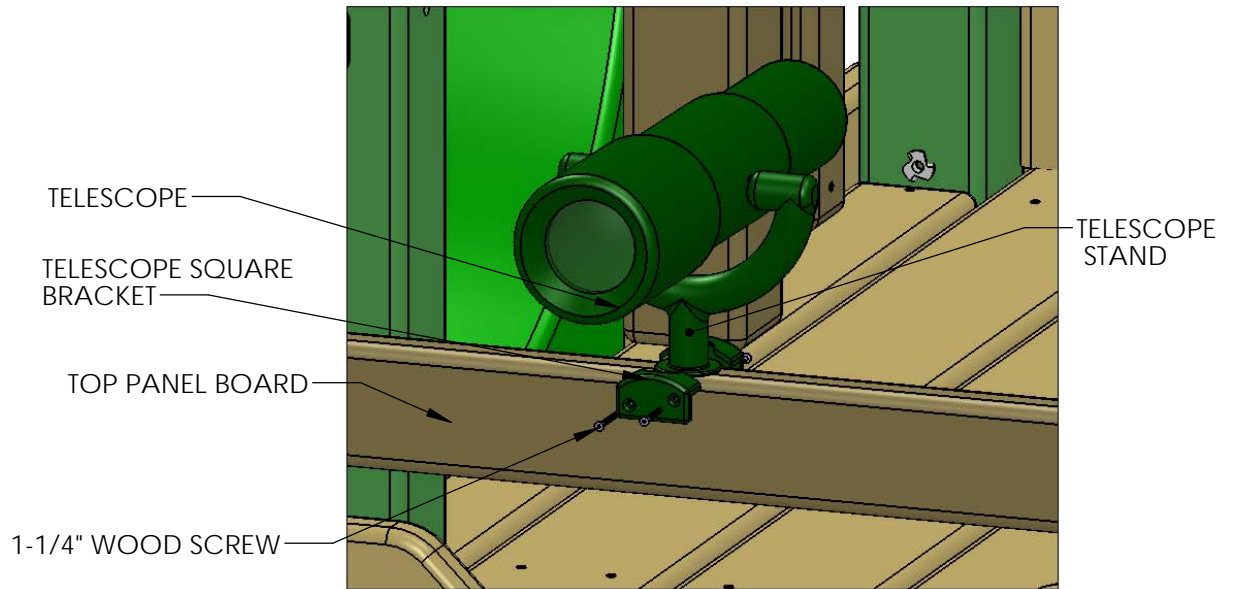



## STEP 64: FLAG KIT

1: PLACE THE PLASTIC BASE OF THE FLAG ONTO THE CORNER POSTS AS SHOWN BELOW.

2: ATTACH THE FLAG TO THE CORNER POST WITH THE PAN HEAD SCREWS PROVIDED WITH THE FLAG.

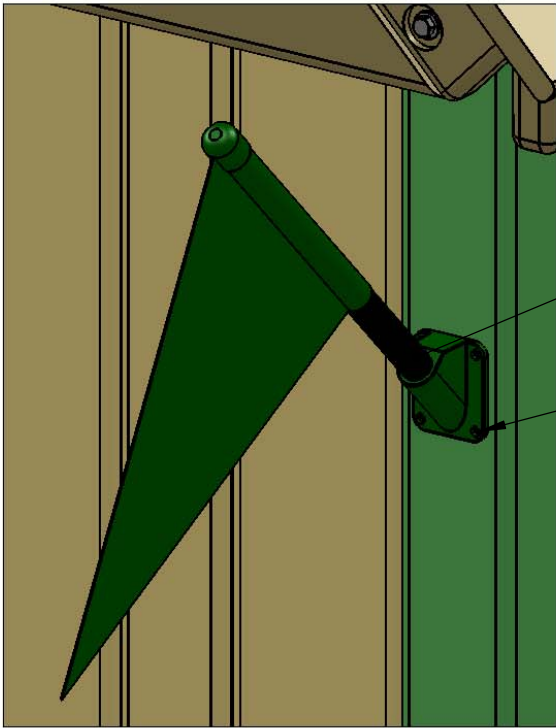

FLAG

PAN HEAD SCREWS  
PROVIDED WITH FLAG.



## STEP 65: CHALKBOARD

- 1: INSTALL THE CHALKBOARD 5" ABOVE THE DECK, MAKE SURE THE CHALKBOARD IS CENTERED ON THE PANEL SLATS.
- 2: FASTEN THE CHALKBOARD TO THE PANEL SLATS WITH 3/4" PAN HEAD SCREWS IN THE OUTER HOLES.

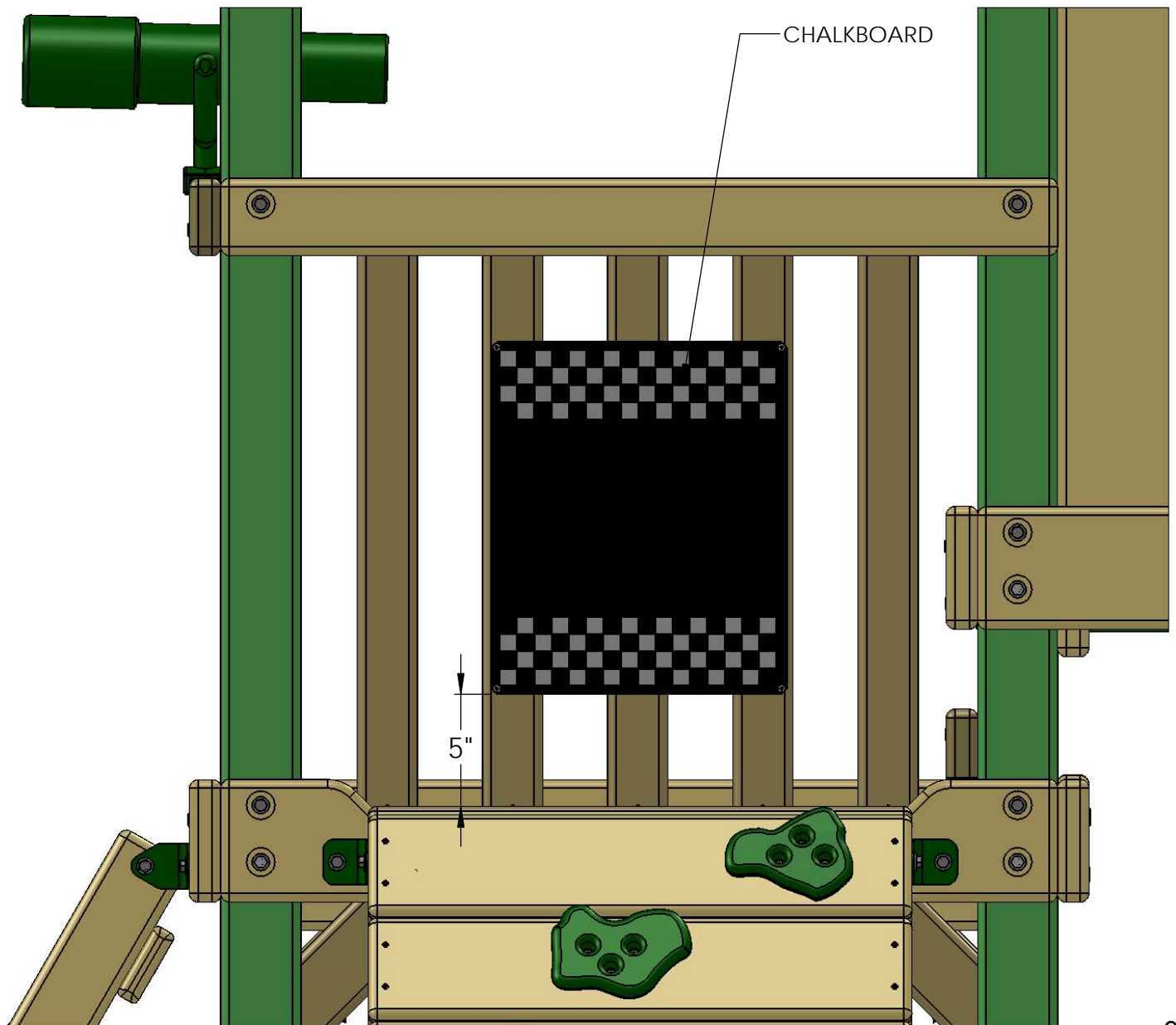



## STEP 66: SAFETY HANDLES

- 1: POSITION THE FIRST SET OF SAFETY HANDLES ON THE PORCH END PANEL SLATS.
- 2: ADJUST THE SAFETY HANDLES UP OR DOWN TO SUIT THE NEEDS OF YOUR CHILD.
- 3: FASTEN THE SAFETY HANDLES TO THE FORT WITH TWO 1-1/4" PAN HEAD SCREWS AND 1/4" WASHERS PROVIDED WITH THE HANDLES.
- 4: THE UPPER LEVEL SAFETY HANDLES SHOULD BE PLACED ON THE CORNER POSTS. ADJUST THE SAFETY HANDLES UP OR DOWN TO SUIT THE NEEDS OF YOUR CHILD. FASTEN THE HANDLES WITH TWO 1-1/4" PAN HEAD SCREWS AND TWO 1/4" WASHERS.

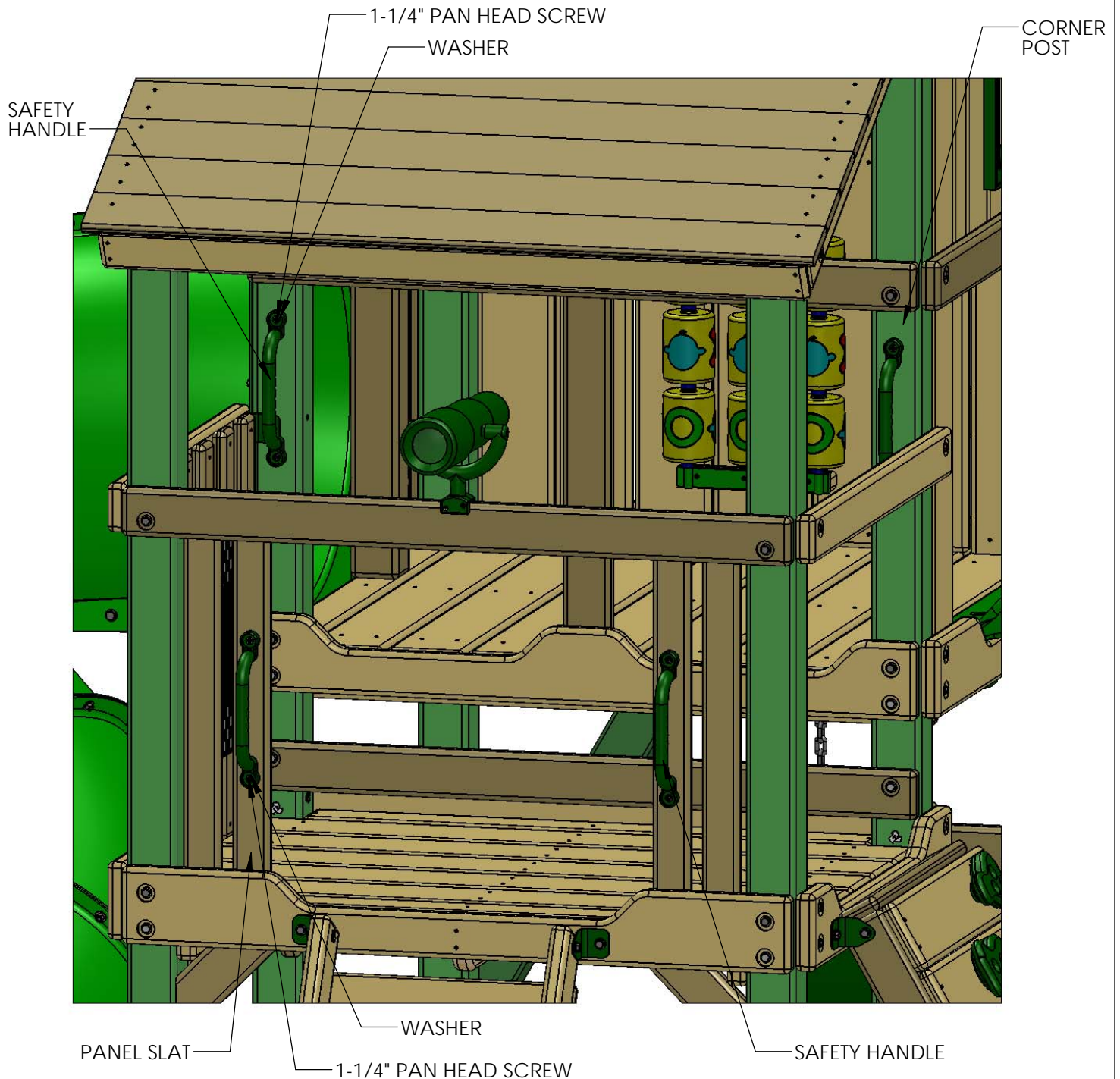

## STEP 67: ROCK WALL ROPE

- 1: A HOLE MUST BE DRILLED INTO THE TOP PANEL BOARD BEFORE THE ROPE CAN BE ATTACHED. MARK THE LOCATION ON THE TOP PANEL BOARD, CENTERED ABOVE THE ROCK WALL, AND USE A 7/8" DRILL BIT TO DRILL THROUGH THE TOP PANEL BOARD.
- 2: TIE THE KNOT ON ONE END OF THE ROPE AND THREAD IT THROUGH THE HOLE DRILLED IN THE TOP PANEL BOARD FROM THE INSIDE OF THE FORT.
- 3: DUE TO EXCESS AMOUNT OF ROPE, WE SUGGEST THAT YOU TIE AT LEAST TWO KNOTS IN THE LENGTH OF THE ROPE. THIS WILL AID YOUR CHILD IN CLIMBING AS WELL.
- 4: LIFT THE ROCK WALL ASSEMBLY, AND THREAD THE ROPE THROUGH THE FRONT OF THE BOTTOM ROCK WALL BOARD. MAKE SURE THE ROPE IS TIGHT, AND THEN TIE A KNOT IN THE ROPE BEHIND THE BOTTOM ROCK WALL BOARD. WHEN YOU LOWER THE ROCK WALL, THIS WILL ALLOW THE ROPE TO FULLY TIGHTEN.

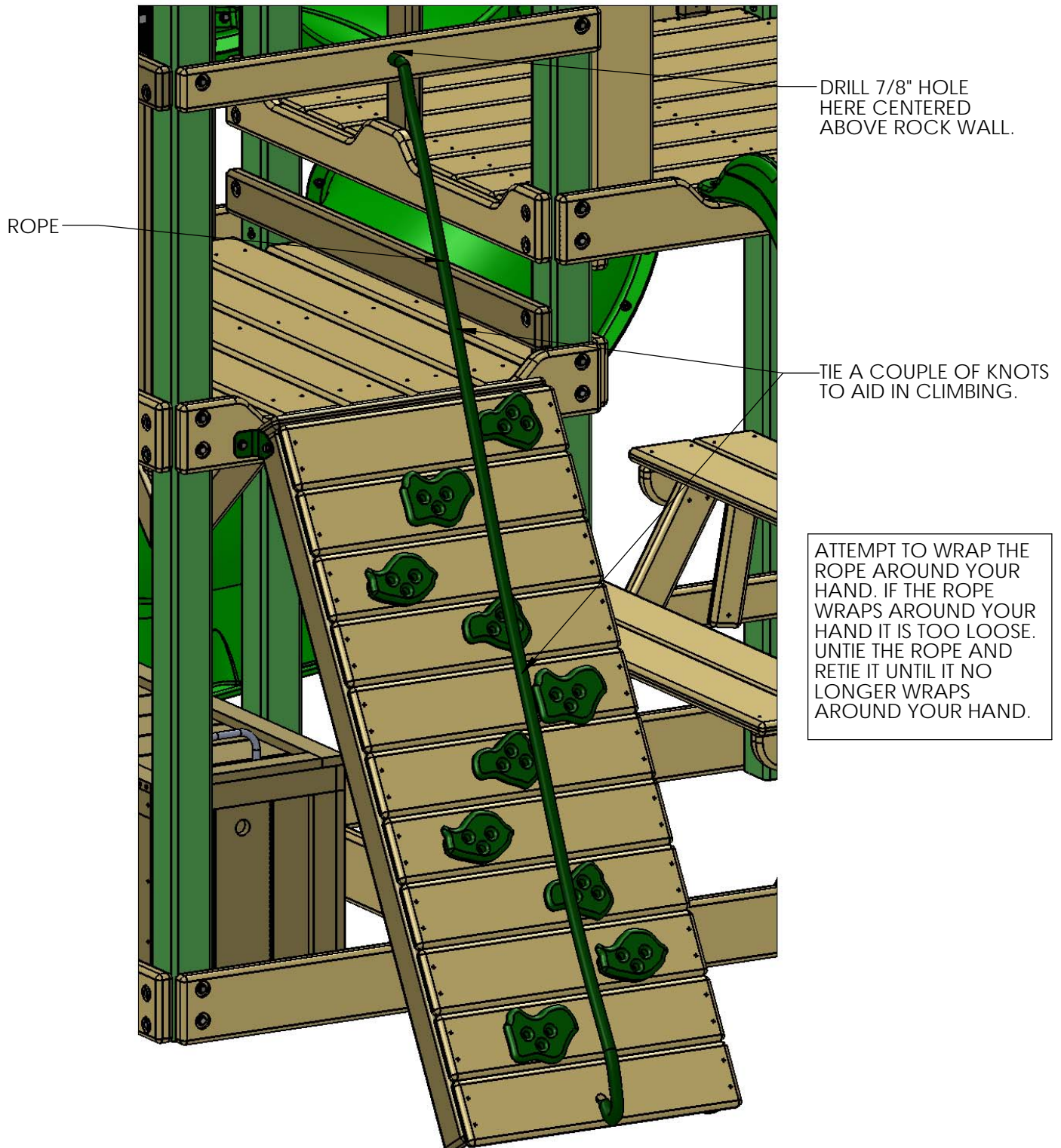

## STEP 68: HANGING THE SWINGS

1: LOCATE THE SWING BELTS, TRAPEZE BAR AND SIX SPRING CLIPS. THE SWING BELTS AND TRAPEZE BAR SHALL BE INSTALLED IN THE LOCATIONS SHOWN BELOW.

2: SNAP A SPRING CLIP ONTO EACH IRON DUCTILE SWING HANGER.

3: HANG ONE CHAIN FROM EACH ACCESSORY ONTO EACH SPRING CLIP.

4: ADJUST SWINGS UP OR DOWN BY CLIPPING ONTO HIGHER OR LOWER CHAIN LINKS.

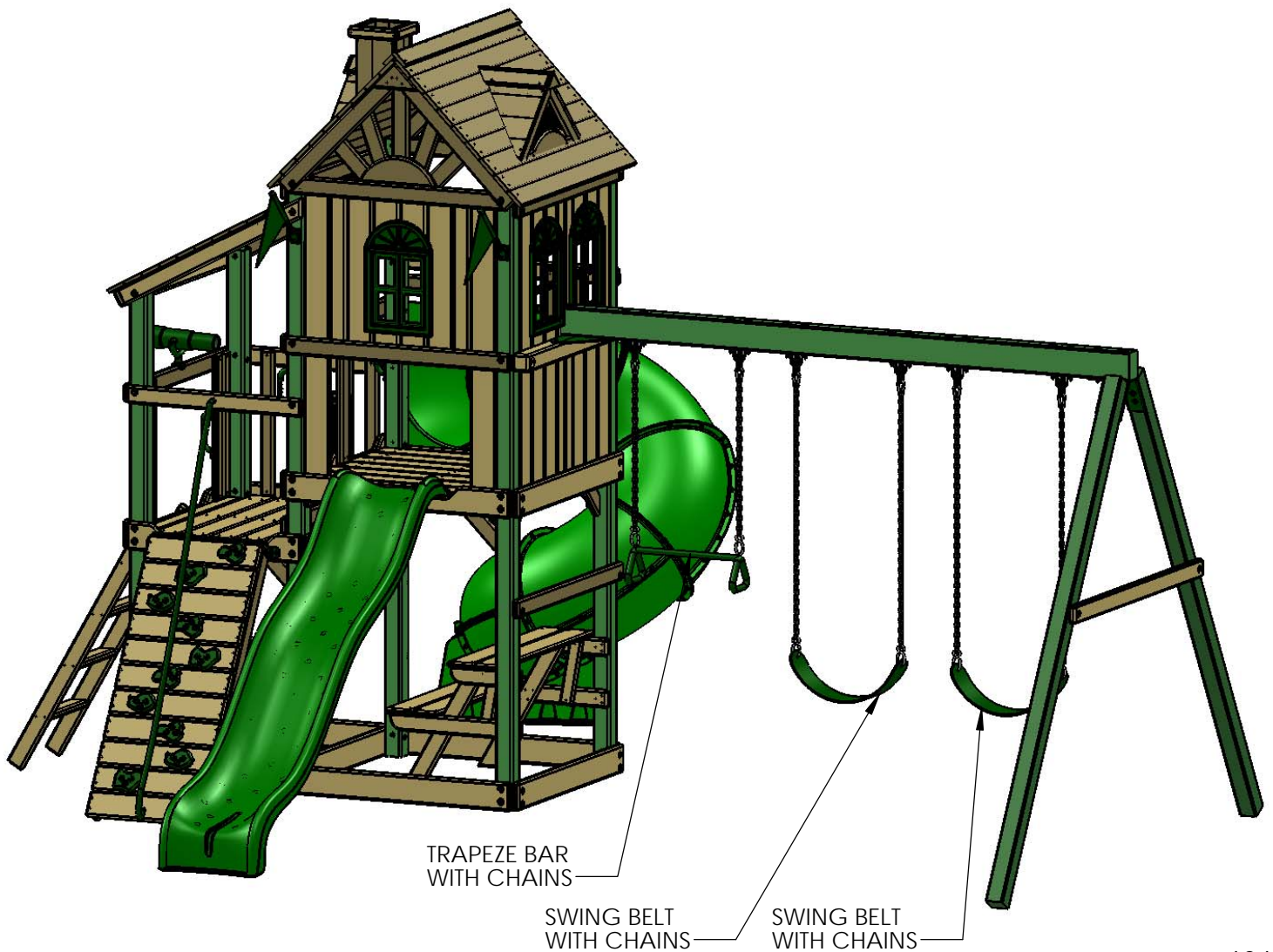
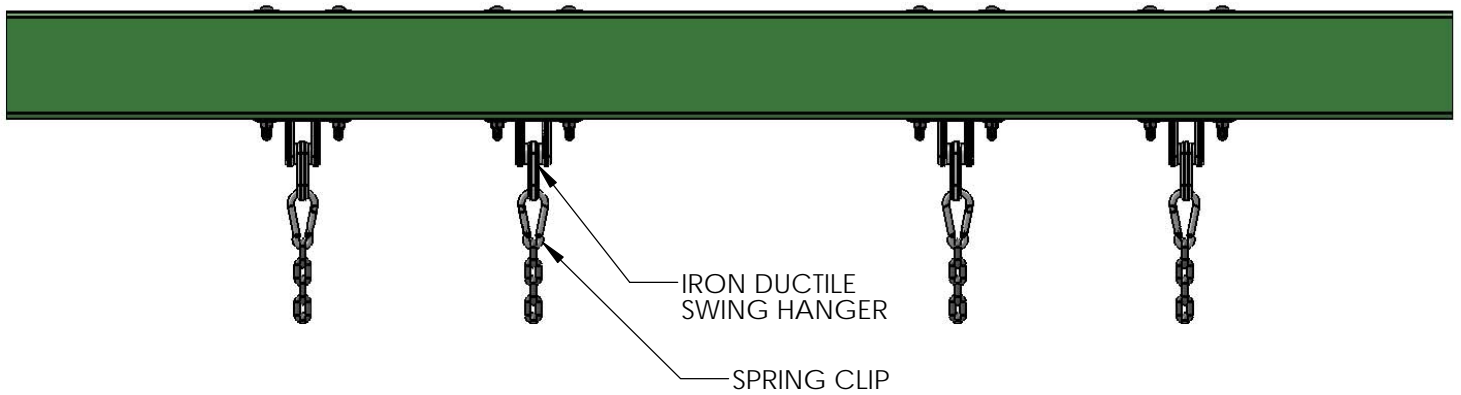



## STEP 69: NAME PLATE

1: FASTEN THE PLAY SET LOGO PLATE CENTERED ONTO THE SWING BEAM WITH TWO 1-1/4" WOOD SCREWS.



## STEP 70: SUNBURST PLASTIC CROWN

1: MOUNT THE PLASTIC CROWN OVER THE WOOD SUN AND FASTEN USING TWO #8 X 1-1/4" WOOD SCREWS.

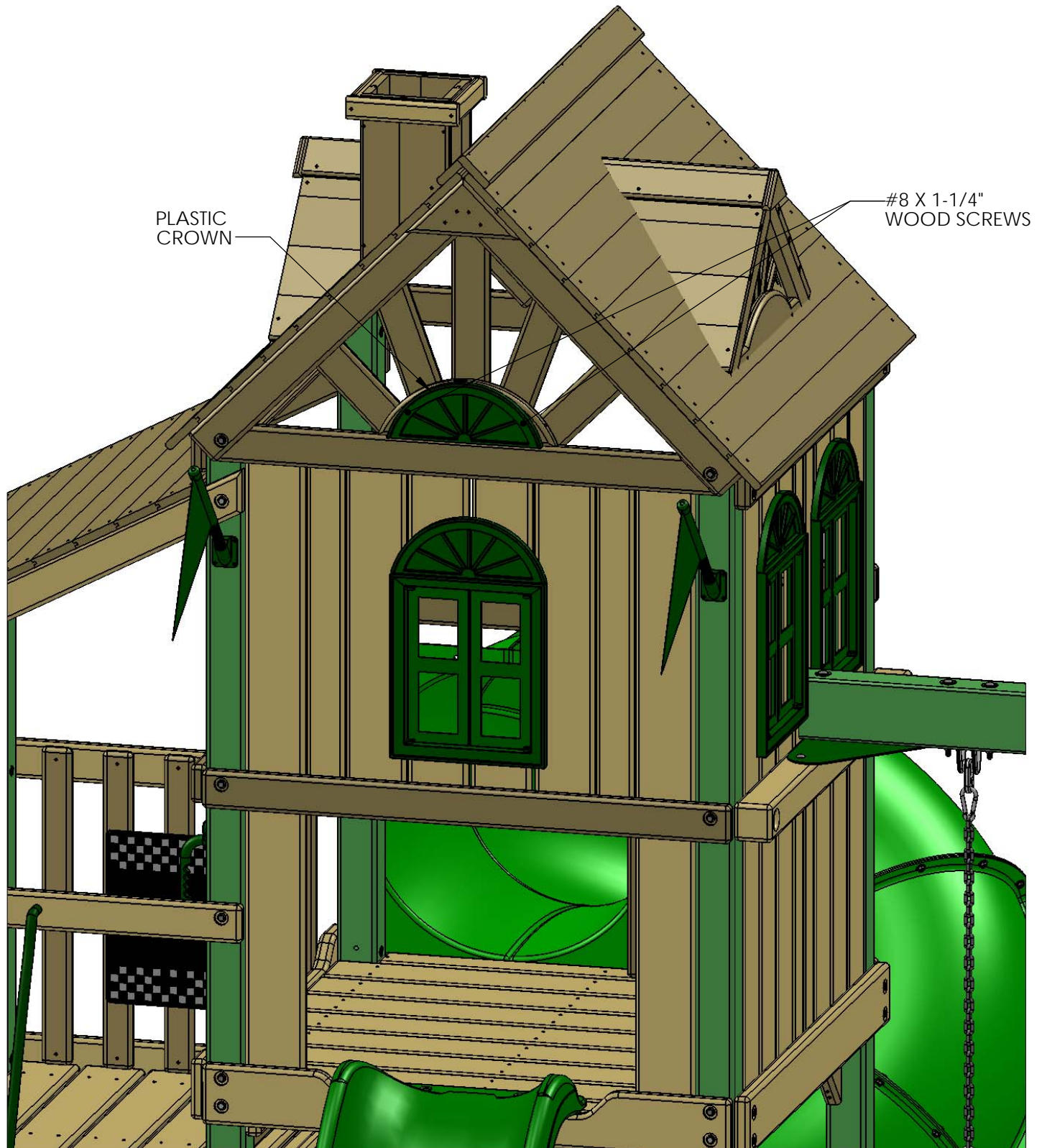



## STEP 71: TELEPHONE

1: THE TELEPHONE MAY BE MOUNTED ANYWHERE ON THE PLAYSET WHERE THERE IS A FLAT SURFACE THAT IS AS WIDE AS THE TELEPHONE.

2: BEFORE INSTALLING THE TELEPHONE CONSIDER THE HEIGHT OF YOUR CHILD SO THAT THEY MAY REACH THE TELEPHONE.

3: FOLLOW THE DIRECTIONS ON THE FOLLOWING PAGE TO INSTALL THE TELEPHONE.

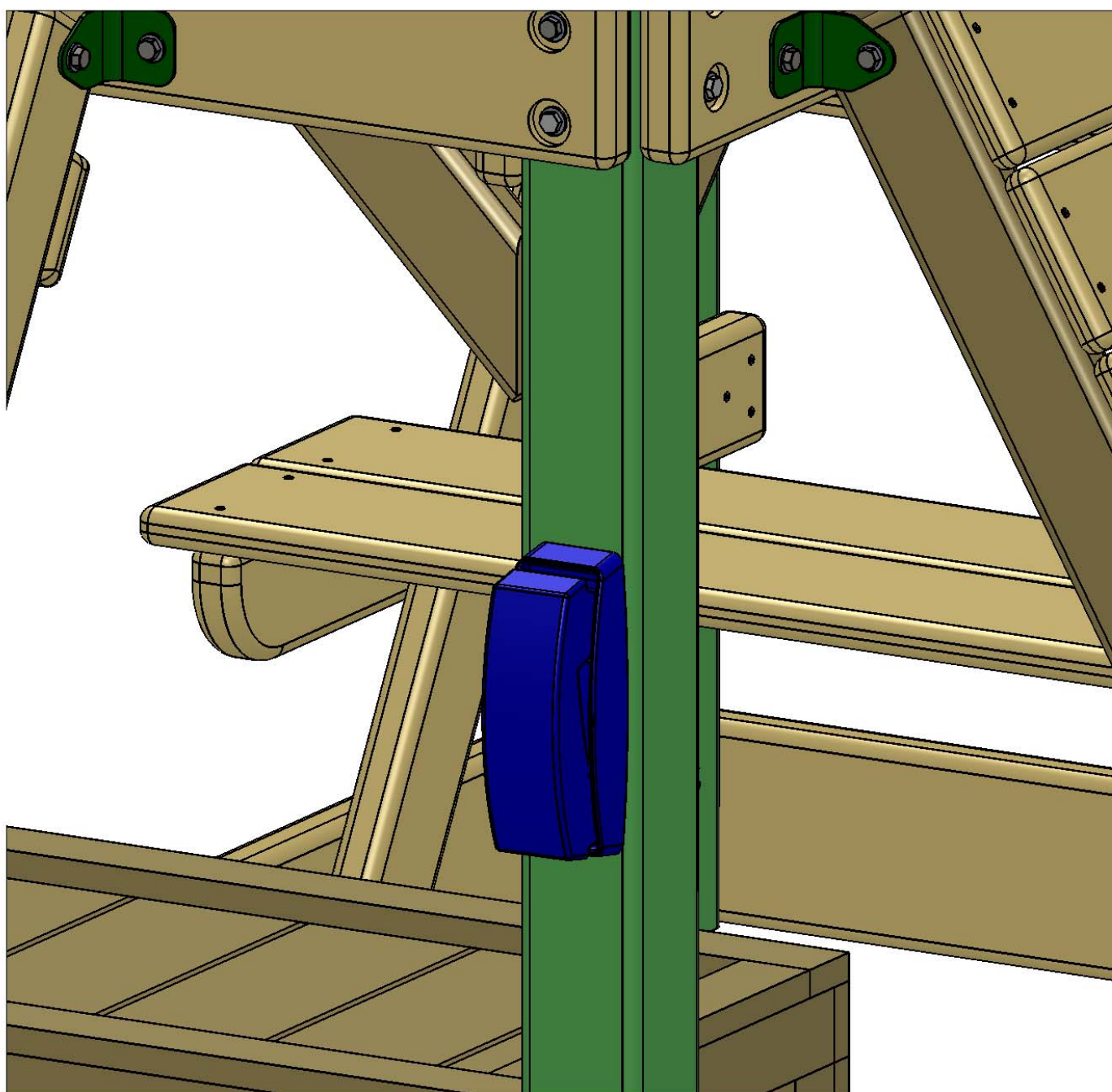

## Phone (07-0014)

1. Place the Phone Base on the top or the side of an existing board on your play set. The board should be at least 1" thick. If the board is not 1" thick then trim the tip of the screw flush to the back side of the board after it is installed.
2. Place the black rubber washer over the end of the 1" long phillips head screw. Insert the screw into the hole in the phone base and screw it into the board. **Do not over-tighten screw.** Over-tightening may cause the plastic to crack.
3. Hang up the Phone onto the Phone base.



Place screw/washer into the hole in the phone base and screw it into the board.

Place phone on board at least 1" thick.

Place black rubber washer over the end of the 1" long phillips head screw.



Hang up the Phone handset onto the Phone Base.



\*Note: Phone is non-functional and is for make-believe-play by children. The Phone has a metal ringer inside that is activated when the child presses the number buttons. No batteries are required.

\*FOR RESIDENTIAL USE ONLY\*  
\*FOR CHILDREN AGES 3-11\*

## STEP 72: GROUND STAKES

1: HAMMER IN THE GROUND STAKES AT AN ANGLE NEXT TO THE SWING LEGS.

2: FASTEN EACH GROUND STAKE TO THE SWING LEG WITH THE 2" SCREW PROVIDED WITH THE GROUND STAKE.

