



# SCHLAGE SENSE™

Smart Deadbolt

Installation Instructions



Download the  
**Schlage Sense**  
app to get started!





# Schlage Sense™ Installation Instructions

ENGLISH

## Package Contents

Camelot Style shown throughout guide.

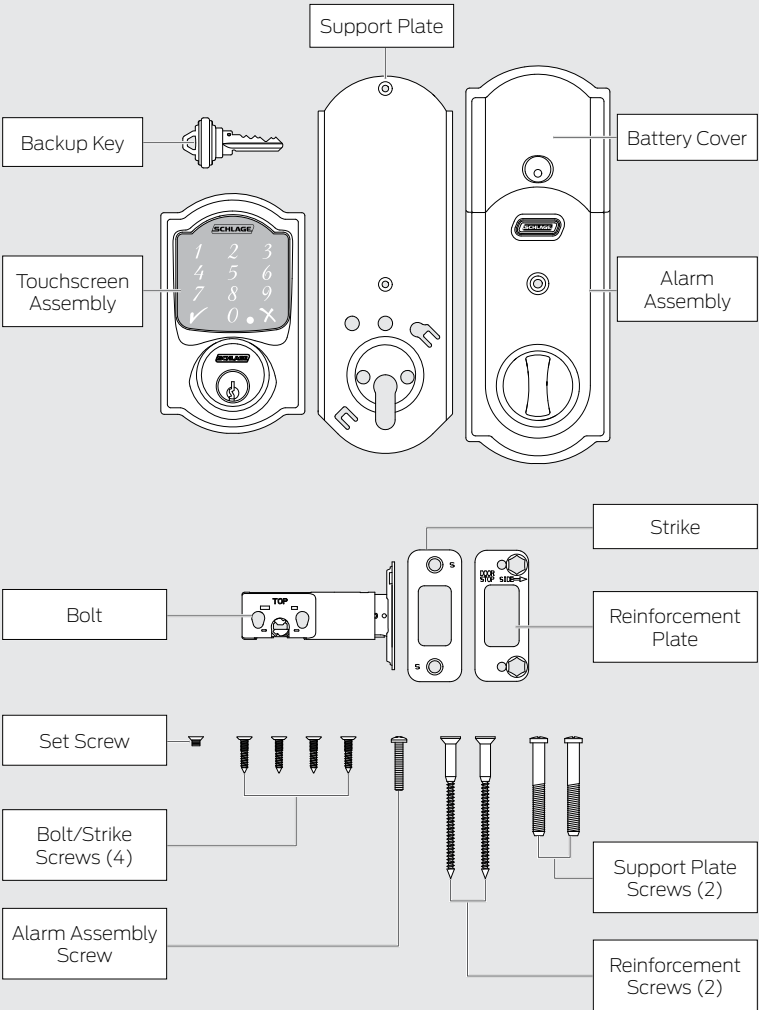

## Need Help?



For technical documents and videos, visit [schlage.com](http://schlage.com)



U.S.A.: 888-805-9837  
Canada: 800-997-4734  
Mexico: 018005067866

# Let's get started!

Once you have all your tools together, please follow each step carefully and in order. Because this is an electronic lock, the order of steps is very important. If you skip a step, you may have to perform a factory default reset and start over.

## You will definitely need this tool:

- Phillips screwdriver  
You can use a manual or electric screwdriver, but please **DO NOT** use a power drill!

## You may also need these tools:

- Tape Measure
- Flathead Screwdriver
- Pencil
- Wood Block
- Hammer

## INSTALLATION NOTES! PLEASE READ!

- **DO NOT** use a power drill for installation! This could damage the lock.
- Please read all the instructions before calling customer support.
- **DO NOT** install the batteries before installing the lock! Follow the instructions in order!
- If you have previously installed this lock on another door, you **MUST** perform a Factory Default Reset **FIRST!** See the **User's Guide** for more information.
- This lock is designed for the following operating temperatures:
  - Outside Lock Body (exterior mounted): -31°F (-35°C) to 151°F (66°C)
  - Inside Lock Body (interior mounted): 14°F (-10°C) to 120°F (49°C)

## Steps at a Glance

1	Check current door/frame alignment.....	4
2	Remove the current deadbolt from the door.....	4
3	Watch the online video.....	4
4	Check door/frame dimensions.....	5
5	Locate programming and User Codes.....	5
6	Install bolt and strike.....	6
6a	Adjust bolt length, if necessary.....	6
6b	Change the faceplate, if necessary.....	6
6c	Install the bolt into the door.....	7
6d	Install the strike into the frame.....	7
6e	Test bolt alignment.....	8
7	Install the Touchscreen Assembly.....	8
7a	Install the Touchscreen on the outside of the door.....	8
7b	Install the Support Plate on the inside of the door.....	9
8	Install the Alarm Assembly.....	9
8a	Remove the battery cover from the Alarm Assembly.....	9
8b	Connect the cable to the Alarm Assembly.....	10
8c	Install the Alarm Assembly.....	10
8d	Secure the Alarm Assembly to the Support Plate.....	11
9	Install the Batteries.....	11
9a	Install the batteries into the battery tray.....	11
9b	Install the battery cover.....	12
10	Set up the Lock.....	12
11	Test the Lock.....	12
11a	Extend the bolt (lock) using the inside thumbturn.....	12
11b	Extend the bolt (lock) using the Touchscreen.....	13
11c	Retract the bolt (unlock) using the Touchscreen.....	13
11d	If the lock failed to lock or unlock:.....	13
12	Continue to the User's Guide.....	15

# UPDATE

# 1 Download the app.

Download the Schlage Sense app from the App Store. Just search for “Schlage Sense” to find the app.



Apple HomeKit™ technology provides an easy, secure way to control your home's lights, doors, thermostats, and more from your iPhone®, iPad®, or iPod touch®.

HomeKit requires an iPhone, iPad, or iPod touch with iOS 8.1 or later.

# 2 Watch the installation video.

**You can access installation videos in the app!** The videos will give you a good overview of the installation process.

Alternatively, please visit [answers.schlage.com](http://answers.schlage.com) and then click on **Schlage Sense**. Watch the video **Installing the Schlage Sense**.

# 3 Check current door/frame alignment.

Because the bolt on this lock is extended automatically, it is important that the door and frame are aligned. Use this checklist to determine if your current alignment will work without any adjustment.

- I can lock the door without pushing, pulling or lifting the door.
- My door alignment—the ability to lock the door easily and smoothly—stays the same with changing seasons.
- When the door is closed, there is space for the deadbolt to extend 1" into the frame when locked.

If you could not check every box in the checklist, you will need to adjust your door and/or frame. Please visit [answers.schlage.com](http://answers.schlage.com) for more information.

# 4 Remove the current deadbolt from the door.

Remove the entire deadbolt, including the bolt. You may also want to remove the strike.

- » In order to maintain BHMA Grade 1, you must install the included reinforcement plate and strike (**see step 7d on page 7**).
- » A standard Schlage deadbolt is shown. Check with your specific deadbolt manufacturer if you need help.

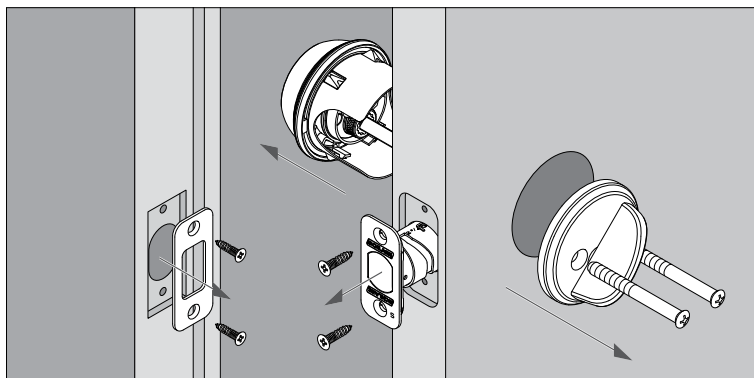

## 5 Check door/frame dimensions.

- Measure the dimensions shown. If your door dimensions do not match, you will need to change your door preparation. Go to [answers.schlage.com](http://answers.schlage.com) for drilling instructions.

» If your door is thicker than 1¾", you will need a thick door kit. Please call Customer Service:

» Mark your **crossbore** and **backset** measurements on this page. You will need these measurements for installation. Either measurement is normal.

### Toll-Free Calling From:

U.S.A.: (888) 805-9837

Canada: (800) 997-4734

Mexico: 018005067866

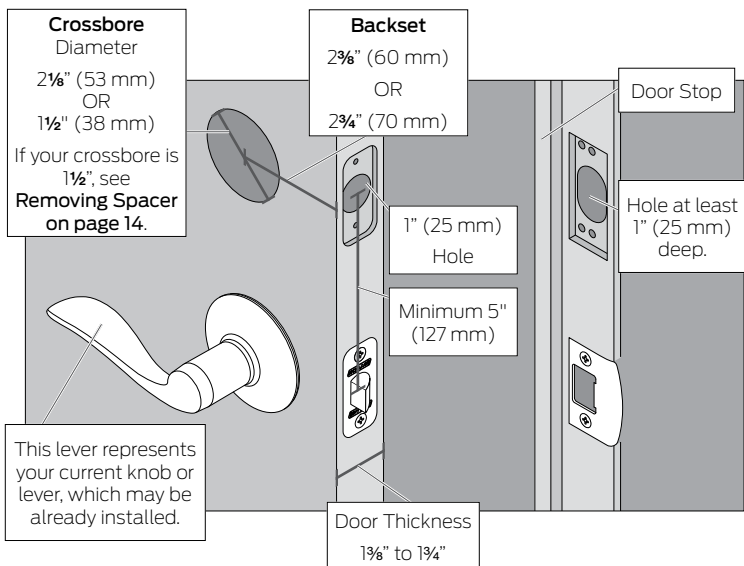

## 6 Locate programming and access codes.

Codes are located on the stickers on the **front of the User's Guide**. You will need these codes to operate the lock. They are also located on the **back of the Alarm Assembly**.

» Do **NOT** remove these stickers from the back of your lock! If you lose your codes, you can reset your lock back to these default codes.

» The HomeKit setup code is used to connect your lock to your iPhone, iPad, or iPod touch.

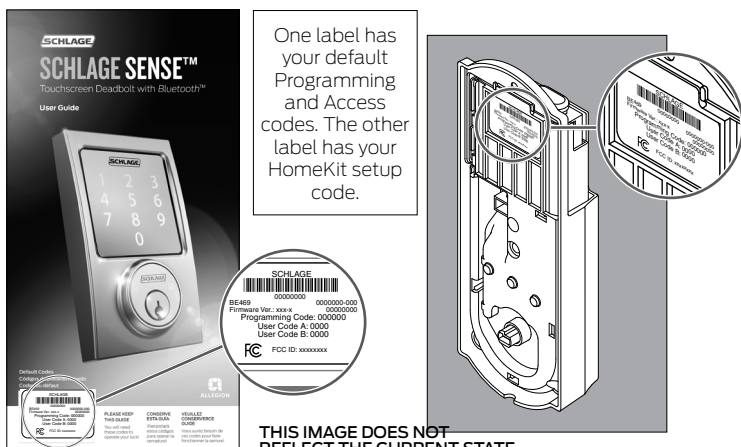

## 7 Install bolt and strike.

### 7a Adjust bolt length, if necessary.

- If the **backset** (see step 5 on page 5) of your door was  $2\frac{3}{8}$ " (60 mm), you do not need to do anything. Proceed to step 7b.
- If the **backset** (see step 5 on page 5) of your door was  $2\frac{3}{4}$ " (70 mm), you need to adjust your bolt. Twist the faceplate until the button pops into the  $2\frac{3}{4}$ " space.

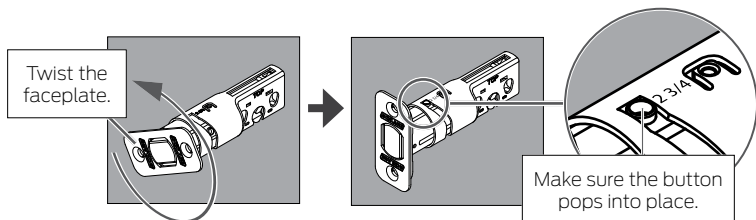

### 7b Change the faceplate, if necessary.

- » In step 7c, your installation will depend on which kind of door edge you had in this step.

**Mortise**  
If your door looks like this, you don't need to do anything. Go to step 7c.

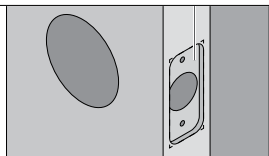

OR

**No Mortise**  
If your door looks like this, complete the steps below.

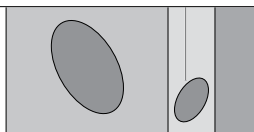

**Alternate Mortise**  
Use the square-corner faceplate if desired.

1. Use a flathead screwdriver to pry the faceplate off.

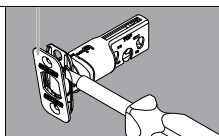

2. Press the square-corner faceplate into place. The faceplate may not stay in place until screws are installed in next step.

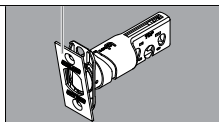

3. Go to step 7c, **Figure A**.

1. Use a flathead screwdriver to pry the faceplate off.

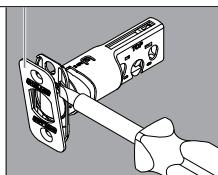

2. Remove the backplate.

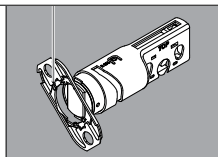

3. Slide the round faceplate into place.

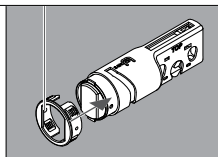

4. Go to step 7c, **Figure B**.

## 7c Install the bolt into the door.

Choose the picture below that matches your door.

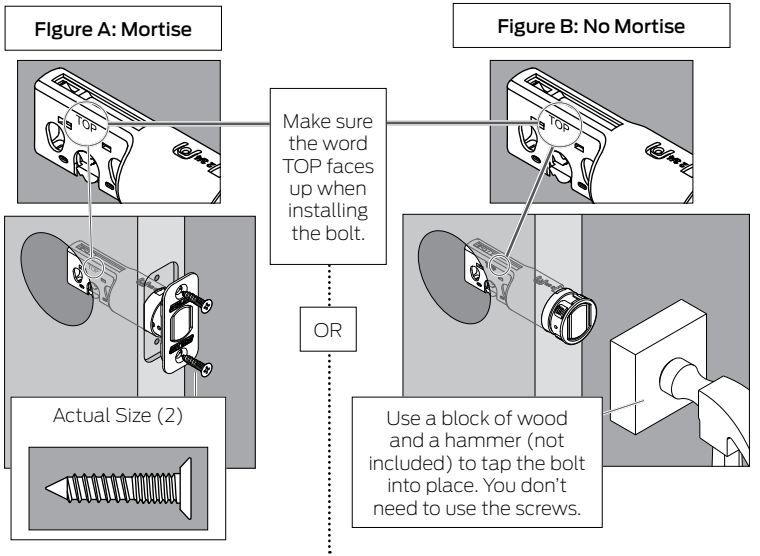

## 7d Install the strike into the frame.

Install all the parts shown for maximum security.

» In order to maintain BHMA Grade 1, you must install the included reinforcement plate and strike.

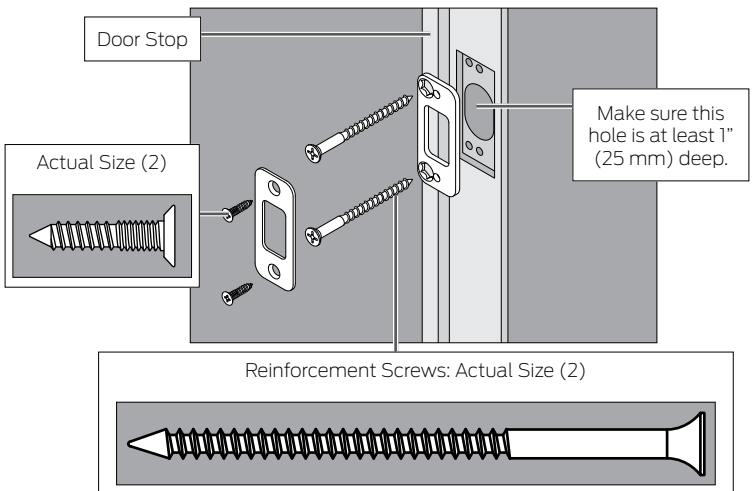

» The reinforcement screws may not fit on doors with sidelights.

## 7e Test bolt alignment.

1. Close the door.
2. Insert a flathead screwdriver into the slot in the bolt, as shown.
3. Rotate the screwdriver toward the door edge to extend the bolt into the hole in the frame. This operation should be smooth. You should be able to rotate the screwdriver 90°, fully extending the bolt.
4. If the operation was not smooth, or if the bolt did not fully extend, adjust your frame and/or door preparation. Go to [answers.schlage.com](https://answers.schlage.com) and watch the video **Proper Alignment of Door and Frame for a Smoothly Operating Lock** for further instructions.
5. Retract (unlock) the bolt before continuing to step 8.

» If the deadbolt continues to rub against the strike, contact Customer Support for an alternate strike with an additional .060" (2 mm) clearance.

### ⚠ CAUTION ⚠

Test from the inside to avoid being locked out!

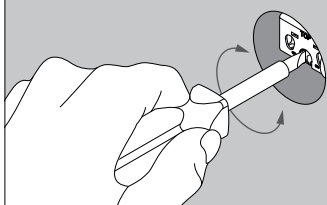

If you can rotate the screwdriver a full 90°, then the bolt is fully extended.

Retract the bolt before continuing to step 8.

## 8 Install the Touchscreen Assembly.

### 8a Install the Touchscreen on the outside of the door.

Always remove the spacer for a 1½" (38 mm) crossbore. See **Spacer Removal** on page 14 before continuing.

- » The clips snap into the **crossbore** (see step 5 on page 5) to assist in holding the keypad on the door.
- » The Touchscreen Assembly should install smoothly. If it does not, check that the bolt is set to the correct **backset** (see step 7a on page 6).
- » NOTE: If you have a **crossbore** (see step 5 on page 5) that is slightly less than 2½" (54 mm), the lock may not install smoothly. You can remove the spacer.

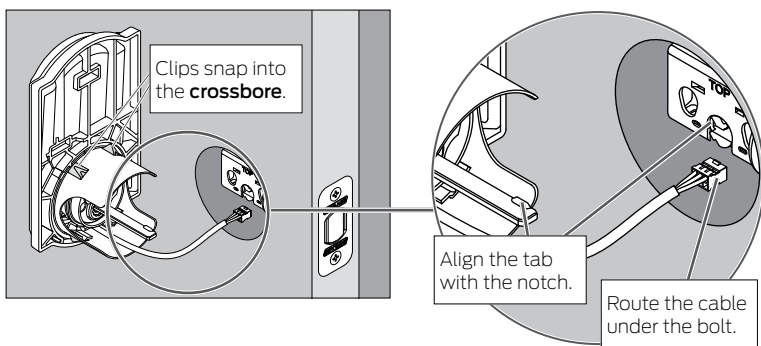



## 8b Install the Support Plate on the inside of the door.

» Make sure the Touchscreen and Support Plate are straight on the door before tightening the screws. Tighten screws fully to prevent the lock from moving over time.

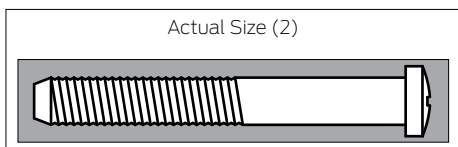
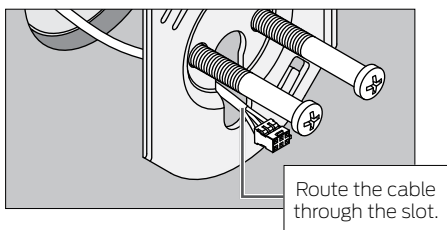
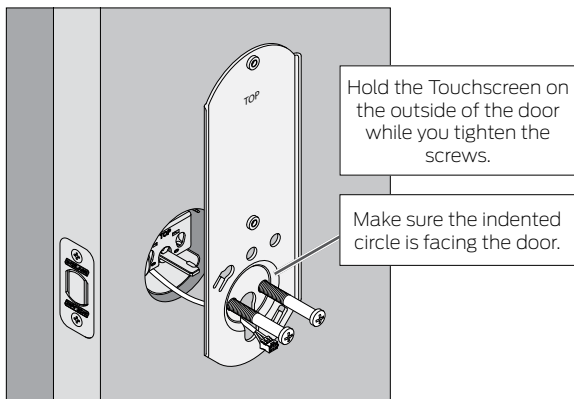

## 9 Install the Alarm Assembly.

9a Remove the battery cover from the Alarm Assembly.

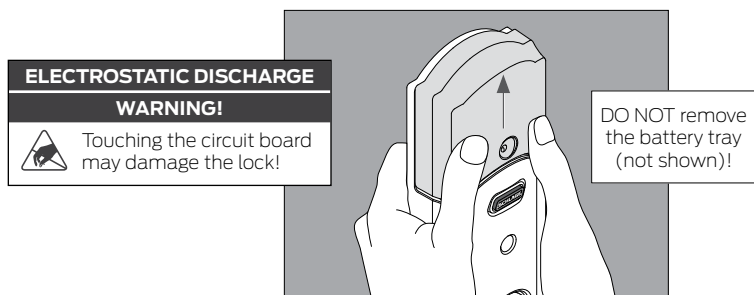

## 9b Connect the cable to the Alarm Assembly.

- »» Locate the screws in step 9d before beginning this step so they will be handy when you need them.

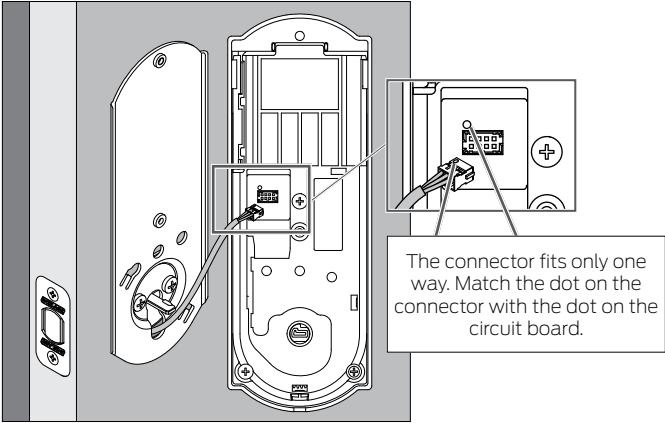

## 9c Install the Alarm Assembly.

1. Align the tab with the notch as shown.
2. Route the cable into the channel.
3. Then slide the Alarm Assembly toward the door.

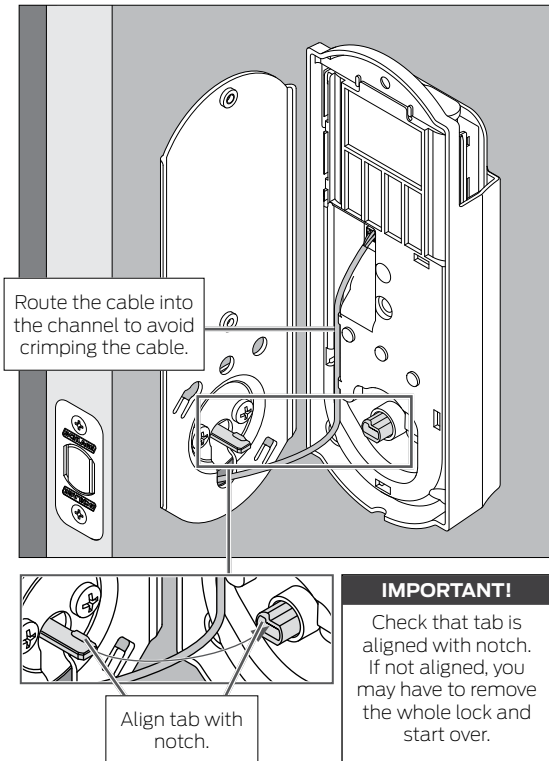

## 9d Secure the Alarm Assembly to the Support Plate.

Install the lower screw first.

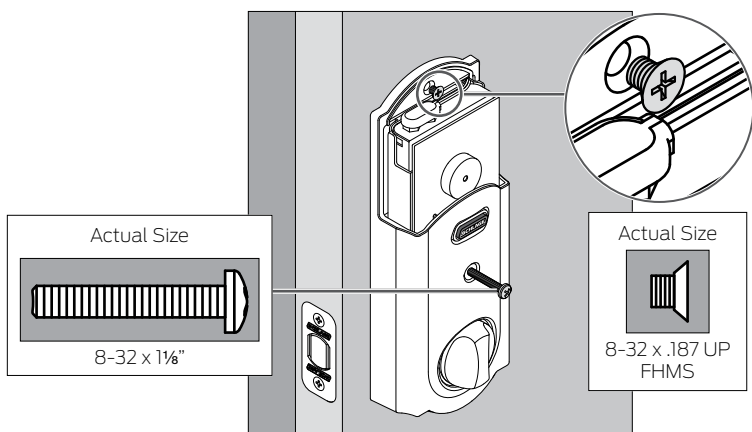

ENGLISH

### NOTE

Please do not rotate the thumbturn at this time. It may not rotate easily. Setup will be performed after installation is complete.

## 10 Install the Batteries.

### 10a Install the batteries into the battery tray.

1. Unsnap the connector.
2. Remove the battery tray.
3. Install four high-quality alkaline AA batteries.  
» Lithium batteries may cause undesirable operation.
4. **Carefully** replace the battery tray, with the batteries facing the door.
5. Snap the connector back into place.

### ELECTROSTATIC DISCHARGE

#### WARNING!



Touching the circuit board may damage the lock!

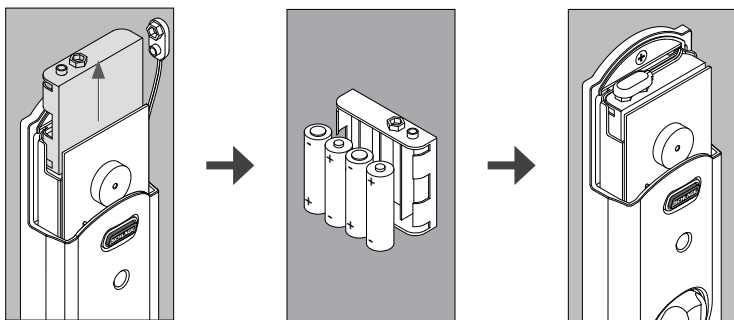

## 10b Install the battery cover.

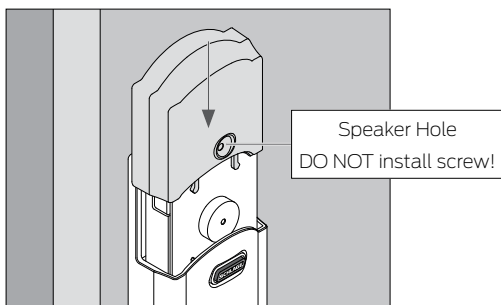

## 11 Set up the Lock.

1. Open the door if it is not already open.
2. Press the Outside Schlage Button.
3. Enter one of the Default Access codes into the lock (**see label shown in step 6 on page 5**).
4. The lock will perform a setup routine. Wait until the bolt stops moving before continuing.

» If the Touchscreen did not light up during this step, you may have a power problem. Install fresh batteries and make sure the battery wires are connected (**see step 10a on page 11**). If that does not help, make sure the cable is connected and is not crimped (**see step 9b on page 10**).

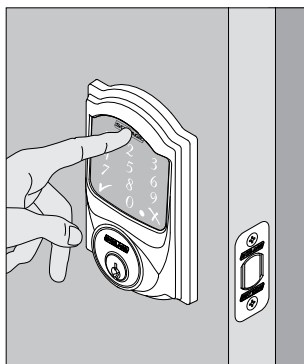

## 12 Test the Lock.

### ⚠ CAUTION ⚠

Keep the key with you during testing to avoid being locked out!

» For complete information about programming and light/beep patterns, see the **Programming the Touchscreen** and **Troubleshooting** sections in the **User's Guide**.

## 12a Extend the bolt (lock) using the inside thumbturn.

1. Close the door.
2. Rotate the thumbturn toward the door jamb to extend the bolt.

Was this operation smooth?

YES



Continue to step 12b.

NO



You may need to adjust your door/frame. Continue to step 12b for further testing, or go to [answers.schlage.com](http://answers.schlage.com) and watch the video **Proper Alignment of Door and Frame for a Smoothly Operating Lock** for adjustment instructions.



## 12b Extend the bolt (lock) using the Touchscreen.

1. Unlock the door using the thumbturn if you have not already.
2. **Take the key and the Default Access codes with you!**  
Go outside and close the door.
3. Press the Outside Schlage Button.
4. The bolt should extend.

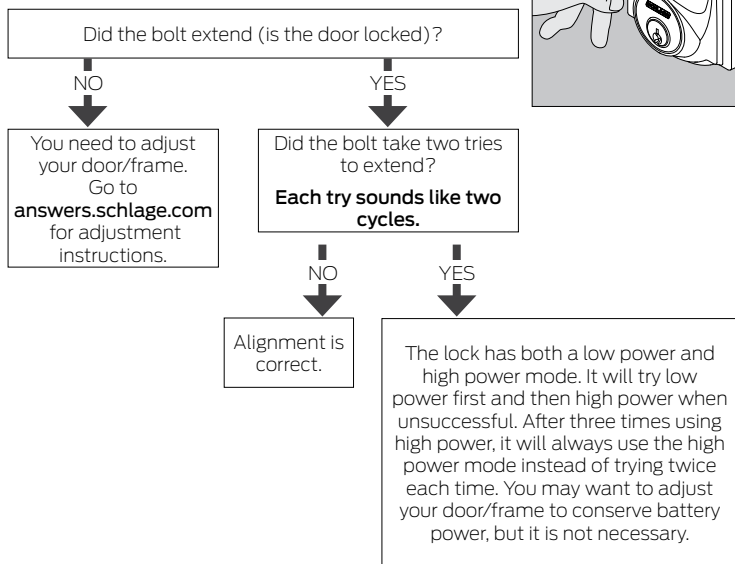
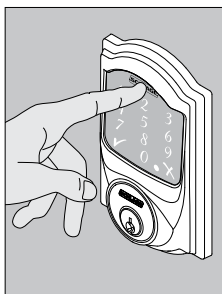

## 12c Retract the bolt (unlock) using the Touchscreen.

1. Press the Schlage button.
2. Enter one of the default Access codes into the lock.
3. The bolt should retract.

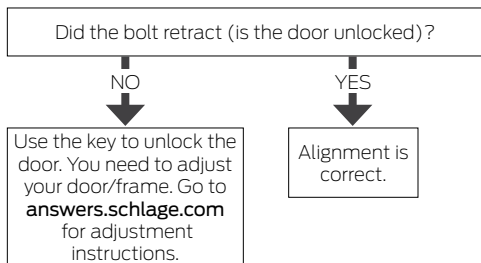
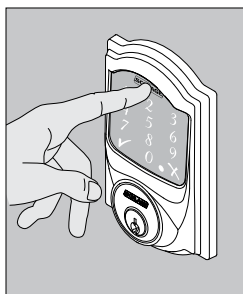

## 12d If the lock failed to lock or unlock:

1. If the Touchscreen did not light up, you may have a power problem. Install fresh batteries and make sure the battery connector is connected (**see step 10a on page 11**). If that does not help, make sure the cable is connected to the Alarm Assembly and is not crimped (**see step 9b on page 10**).
2. If the lock had power but you need to adjust your door/frame, please go online to [answers.schlage.com](https://answers.schlage.com) for complete adjustment instructions and videos.

# Spacer Removal

## (Option for small crossbores only)

ONLY if your door has less than a 2½" (54 mm) **crossbore**, remove the spacer as shown.

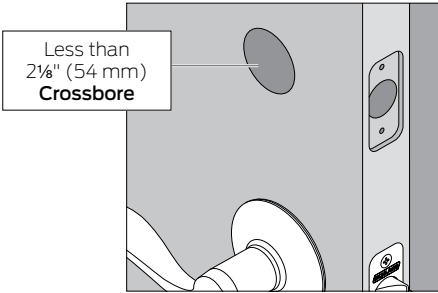

ENGLISH



1. Remove screw.

2. Rotate and remove spacer.

3. Replace screw.

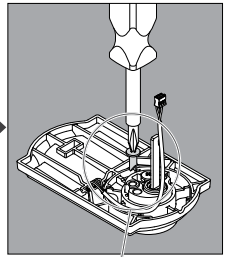
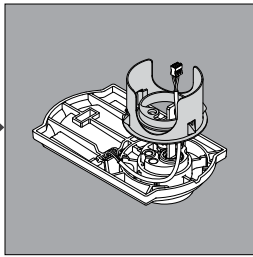
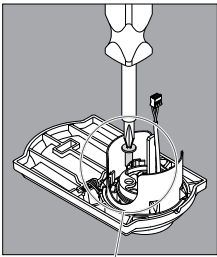

## 13 Continue to the User Guide.

Your lock is installed and functional. Continue to the **User Guide** for complete information about how to configure and operate the lock and alarm.

Questions about your new  
**Schlage Sense™** Smart Deadbolt?

**Please don't return it to the store!**

Let us help you first!

Apple, iPhone, iPad, iPad Air, and iPod touch are trademarks of Apple Inc., registered in the U.S. and other countries. HomeKit is a trademark of Apple Inc.

### Need Help?



For technical documents and videos, visit **[schlage.com](https://www.schlage.com)** or download the Schlage Sense app.



U.S.A.: 888-805-9837  
Canada: 800-997-4734  
Mexico: 018005067866

If you have questions about any part of installation or programming, don't return your Schlage Sense™ to the store. Our Schlage Customer Service representatives are ready to help.

**Toll-free:** 888-805-9837  
**answers.schlage.com**

Si tiene dudas acerca de cualquier parte de la instalación o programación, no devuelva su Schlage Sense a la tienda. Nuestros representantes del Departamento de Servicio de Asistencia al Cliente de Schlage están listos para ayudarlo.

**Toll-free:** 018005067866  
**answers.schlage.com**

Si vous avez des questions à propos de l'installation ou de la programmation, ne retournez pas votre serrure Schlage Sense au magasin. Les représentants du service à la clientèle de Schlage sont à votre service.

**Sans frais :** 800-997-4734  
**answers.schlage.com**

# A NEW KIND OF KEYLESS.



P516-990

© Allegion 2015  
Printed in U.S.A.  
P516-990 Rev. 07/15-b

