

Installation Instructions

Air Conditioner

? Questions? Call 800.GE.CARES (800.432.2737) or Visit our Website at: GEAppliances.com

BEFORE YOU BEGIN

Read these instructions completely and carefully.

- **IMPORTANT** — Save these instructions for local inspector's use.
- **IMPORTANT** — Observe all governing codes and ordinances.
- **Note to Installer** – Be sure to leave these instructions with the Consumer.
- **Note to Consumer** – Keep these instructions for future reference.
- **Skill level** – Installation of this appliance requires basic mechanical skills.
- **Completion time** – Approximately 1 hour
- We recommend that two people install this product.
- Proper installation is the responsibility of the installer.
- Product failure due to improper installation is not covered under the Warranty.
- You **MUST** use all supplied parts and use proper installation procedures as described in these instructions when installing this air conditioner.

ELECTRICAL REQUIREMENTS

 Some models require a 115/120-volt AC, 60-Hz grounded outlet protected with a 15-amp time-delay fuse or circuit breaker.

The 3-prong grounding plug minimizes the possibility of electric shock hazard. If the wall outlet you plan to use is only a 2-prong outlet, it is your responsibility to have it replaced with a properly grounded 3-prong wall outlet.

 Some models require 230/208-volt AC, protected with a time-delay fuse or circuit breaker. These models should be installed on their own single branch circuit for best performance and to prevent overloading house or apartment wiring circuits, which could cause a possible fire hazard from overheating wires.

CAUTION:

Do not, under any circumstances, cut or remove the third (ground) prong from the power cord.

Do not change the plug on the power cord of this air conditioner.

Aluminum house wiring may present special problems—consult a qualified electrician.

TOOLS YOU WILL NEED

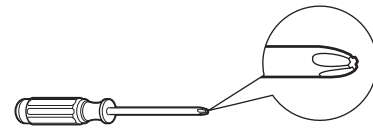

Phillips head screwdriver



Flat-blade screwdriver



Pencil

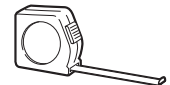

Ruler or tape measure



Level

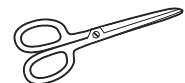

Scissors or knife

Power cord includes a current interrupter device. A test and reset button is provided on the plug case. The device should be tested on a periodic basis by first pressing the **TEST** button and then the **RESET** button while plugged into the outlet. If the **TEST** button does not trip or if the **RESET** button will not stay engaged, discontinue use of the air conditioner and contact a qualified service technician.

Installation Instructions

PARTS INCLUDED (Appearance may vary)

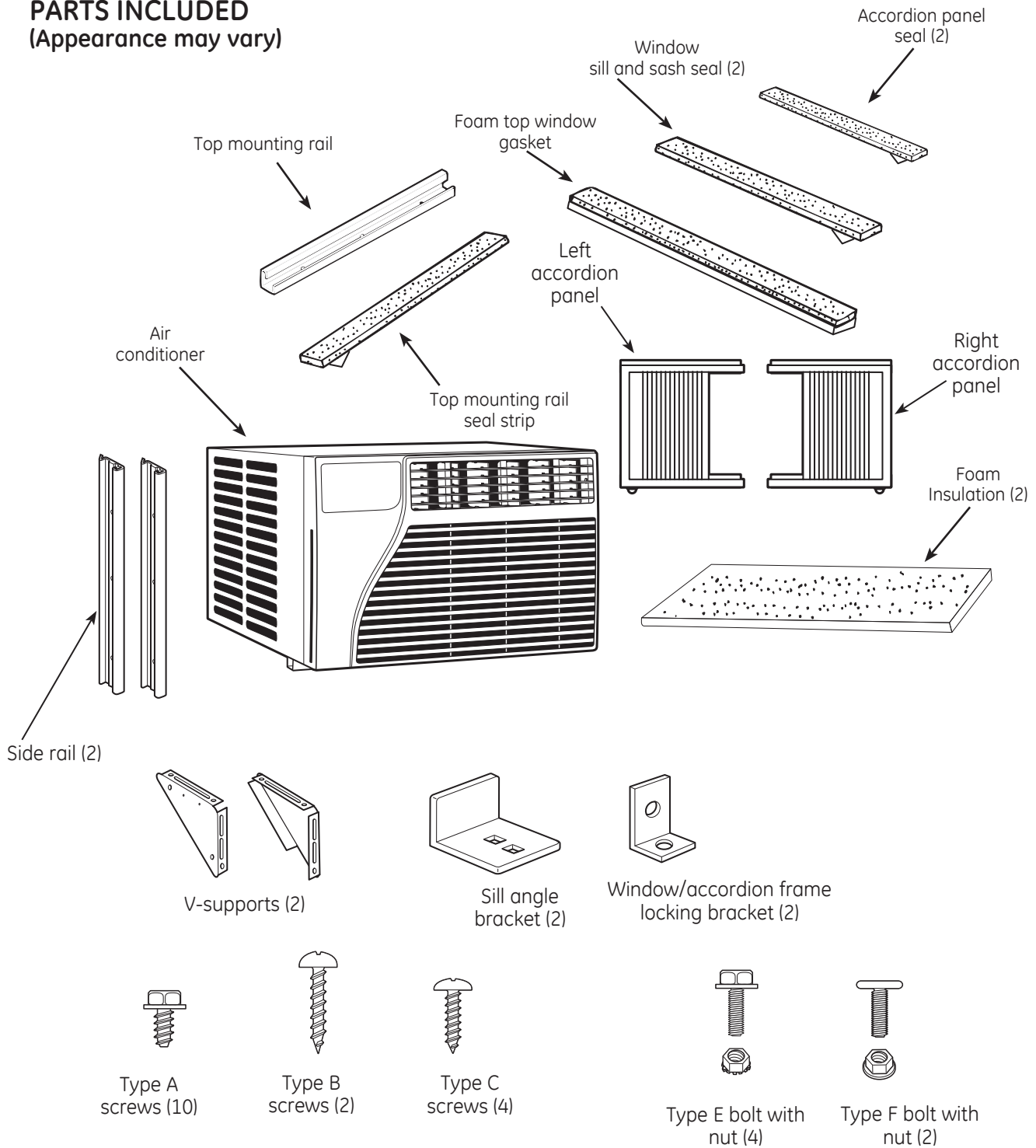

Installation Instructions

1 WINDOW REQUIREMENTS

- These instructions are for a standard double-hung window. You will need to modify them for other types of windows.
- All supporting parts must be secured to firm wood, masonry or metal.
- The electrical outlet must be within reach of the power cord.
- Follow the dimensions in the table and illustration for your model.

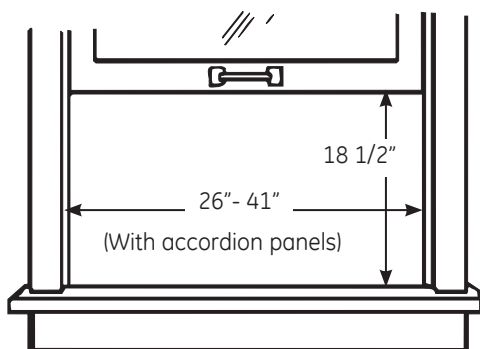

2 STORM WINDOW REQUIREMENTS

A storm window frame will not allow the air conditioner to tilt toward the outside, and will keep it from draining properly.

To adjust for this, attach a piece of wood to the sill.

WOOD PIECES

WIDTH: 2"

LENGTH: Long enough to fit inside the window frame.

THICKNESS: To determine the thickness, place a piece of wood on the sill to make it 1/2" higher than the top of the storm window frame or the vinyl frame.

Attach securely with nails or screws provided by the installer.

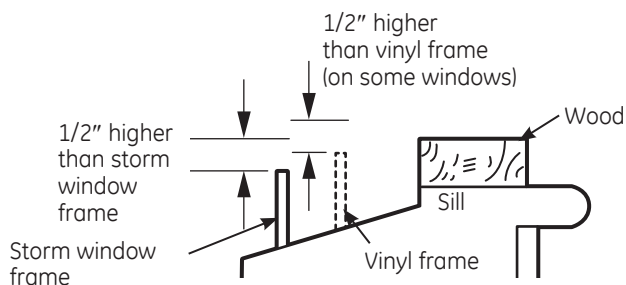

3 PREPARE THE AIR CONDITIONER

- A** Pull down the front panel and remove the filter. Remove the front panel by lifting up at an angle.

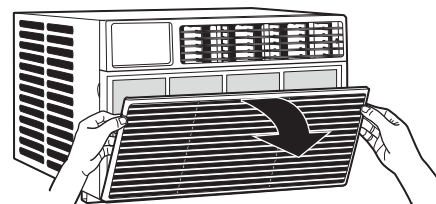

- B** Remove the four front screws. Save them for reinstalling the front housing.

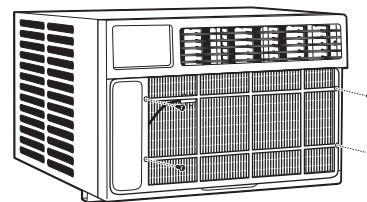

- C** Grasp the lower corners of the grille while pressing in on the case sides with your finger tips. Pull out to release and lift it up.

NOTE: Do not pull the bottom edge toward you more than 3" or you may damage the tabs of the grille.

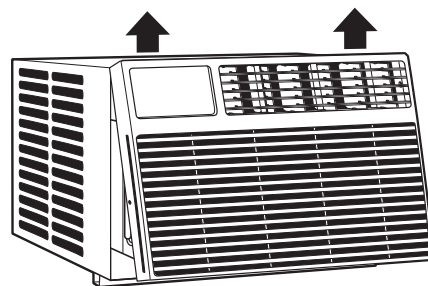

- D** When the front grille is removed the control panel will still be attached by a harness. Turn the grille around so you can see the back side of the grille. Remove the 2 screws to separate the control panel housing from the grille.

NOTE: Be sure to save these screws. You will need them later in the installation.

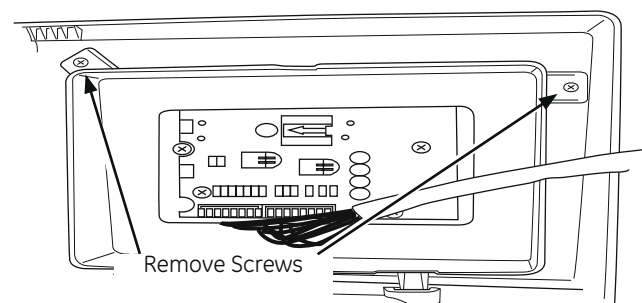

Installation Instructions

3 PREPARE THE AIR CONDITIONER (continues)

- E** Remove the ground screw from the left side of the case. Keep it in a safe location. **NOTE: Be sure to save this screw. You will need it later in the installation.**

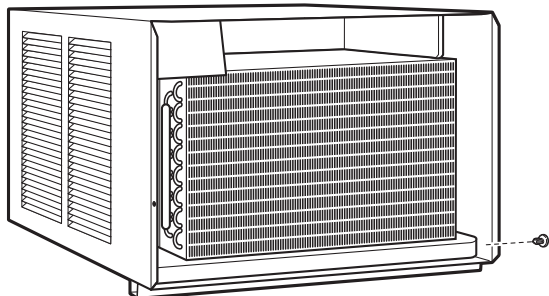

- F** Slide the air conditioner from the case by gripping the base pan handle and pulling forward while bracing the case. Do not pull or lift on the foam discharge area.

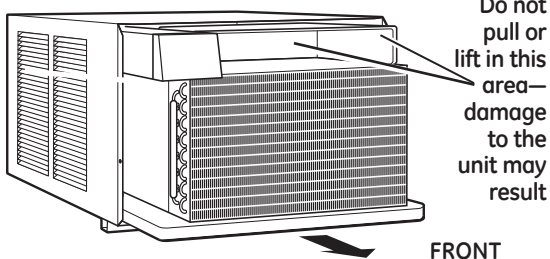

4 PREPARE THE CASE

- A** Attach the top rail gasket to the bottom of the top rail.

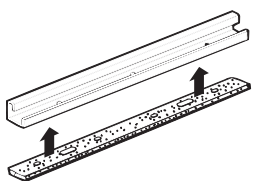

- B** Install the top mounting rail with 4 type A screws from the inside of the case. Press firmly to drive the screws into the gasket and through the top mounting rail.

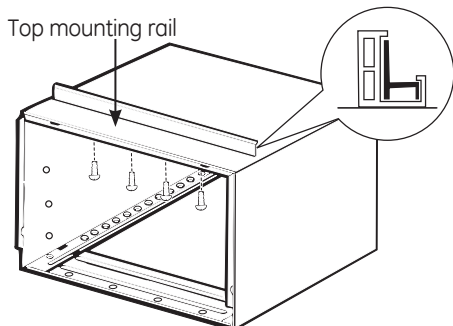

4 PREPARE THE CASE

- C** Slide each side retainer onto the edge of each accordion panel. The figure shows the orientation of each accordion panel and side retainer assembly relative to the case from a top view of the unit.

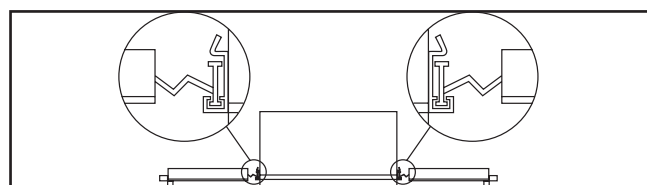
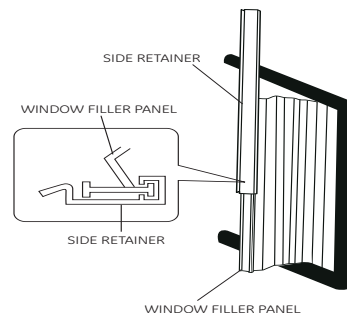

- D** Remove the backing from the accordion seal (two short strips). Stick one sealing strip respectively on the left side and right side of the accordion panels, as shown.

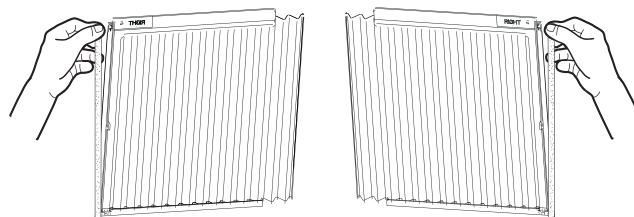

- E** Slide the left and right accordion panels into the top and bottom mounting rails.

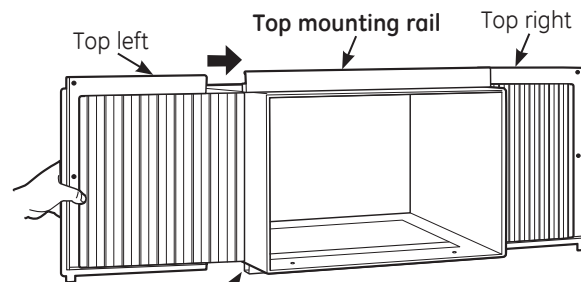

- F** Attach the side retainers to the case using 6 type A screws.

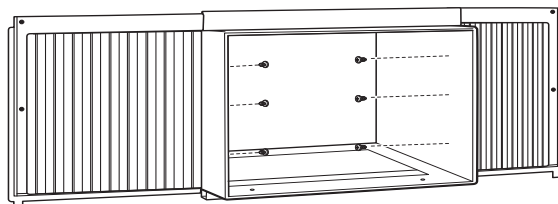

Installation Instructions

5 PREPARE THE WINDOW AND INSTALL THE CASE

- A** Cut the window seal (2 long strips) to the proper length. Peel off the backing and attach the seal to the underside of the window sash. One attached to sash and one attached to sill.

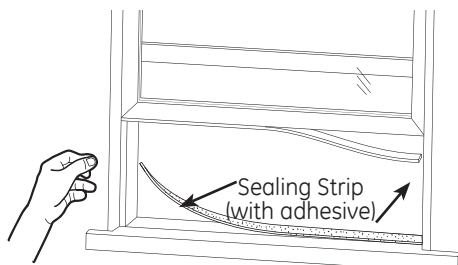

- B** Open the window and mark the center of the window sill.

- C** Carefully slide the case into the window and center the case. Lower the window behind the top mounting rail. Pull the bottom of the case forward so that the bottom mounting rail is tight against the back of the window stool. Mount the case to the window sill using 2 type B screws. Drill pilot holes, if necessary.

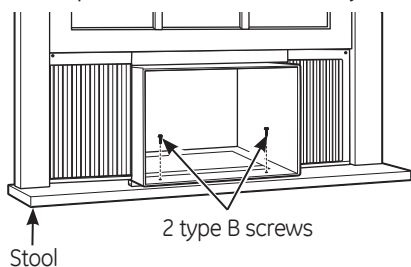

- D** Assemble the V-support and V-support bracket with Type F nut and bolt.

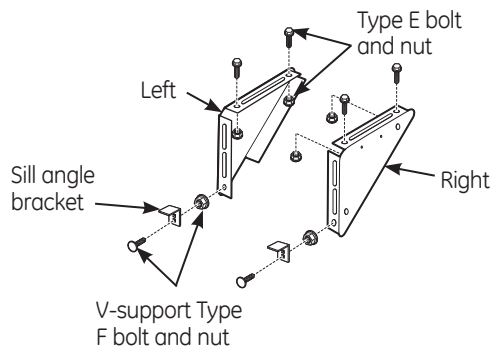

5 PREPARE THE WINDOW AND INSTALL THE CASE (continues)

- E** Position the V-supports on the case bottom so that they will be near the outside wall. Attach a V-support to each side of the bottom of the case with Type E bolts, 2 for each support.

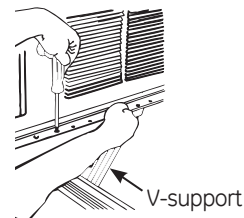

- F** Adjust sill angle brackets to rest on sill.

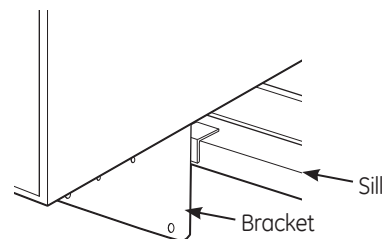

- G** Extend the left and right accordion panels to the vertical window sashes. Drill pilot holes and attach the top corners with 2 type C screws.

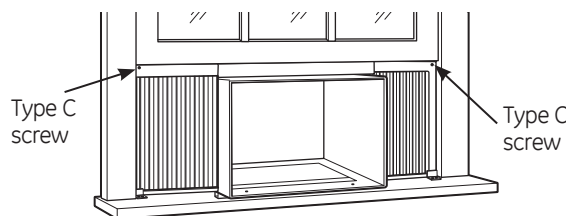

Installation Instructions

5 PREPARE THE WINDOW AND INSTALL THE CASE (continues)

H **CAUTION:**

To prevent broken glass or damage to windows, on vinyl or other similarly constructed windows, attach the window locking bracket to the window side jamb.

Attach the window locking bracket with one Type C screw.

This unit contains two window locking brackets.

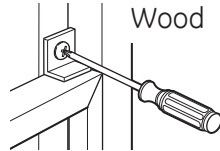
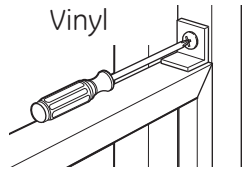

I Cut the foam top window gasket to the window width.

J Stuff the foam between the glass and the window to prevent air and insects from getting into the room.

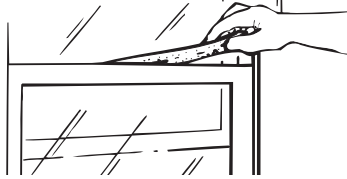

NOTE: If the gasket supplied does not fit your window, obtain appropriate material locally to provide a proper installation seal.

6 INSTALL THE AIR CONDITIONER IN THE CASE

A Slide the air conditioner into the case by the base pan. Do not push on the controls, foam air discharge housing or the finned coils. Make sure the air conditioner is firmly seated.

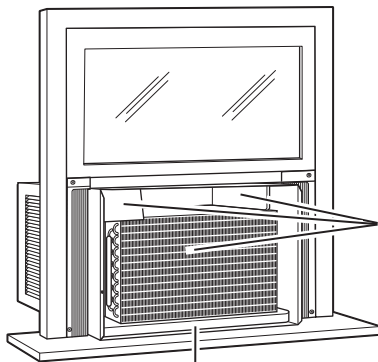

Base Pan

Do not press on these areas—damage to the unit may result

6 INSTALL THE AIR CONDITIONER IN THE CASE (continues)

B Replace the 1 screw removed earlier, in the side of the case.

IMPORTANT: THE GROUND SCREW MUST BE REINSTALLED TO ENSURE PROPER GROUND.

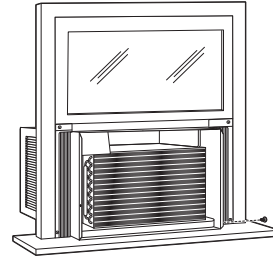

C Reinstall the control to the panel housing by replacing the 2 screws you removed earlier.

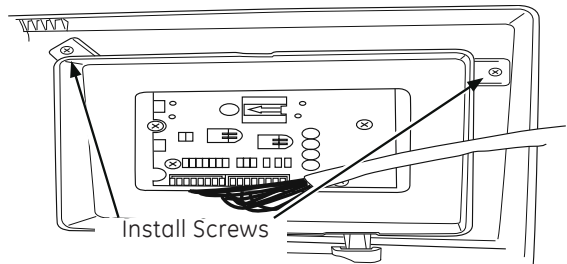

D Attach the front grille to the case by inserting the tabs on the grille into the slots on the front top of the case. Push the grille in.

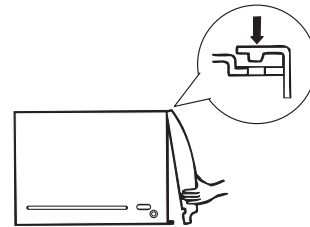

E Replace the screws.

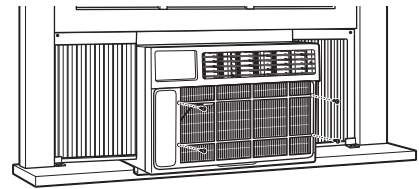

F Install the filter and the front grille.

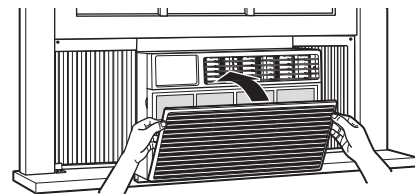

G Plug in the air conditioner.

Installation Instructions

8 INSTALL FOAM INSULATION

Additional insulation is provided with your window air conditioner to reduce heat leakage into the home, reducing overall energy usage.

- A** After the air conditioner is installed in the window measure the length of the accordion for both sides.

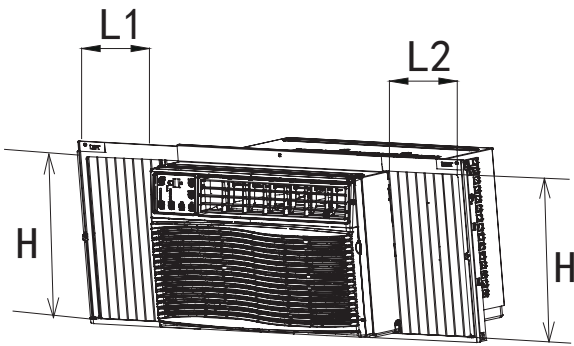

- B** Cut the foam insulation to the measured length of the left and right side accordion.
NOTE: Be sure to measure each accordion because the length could be different on each side.

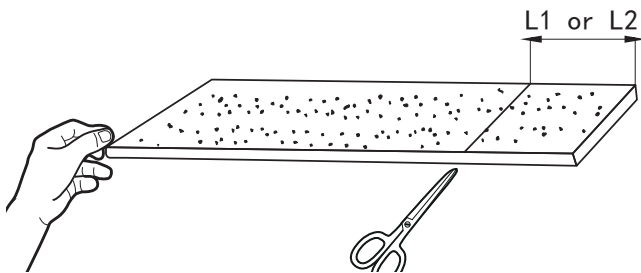

- C** Remove adhesive from back of foam insulation. Stick the foam insulation onto the left and right accordion, and inside of the frames.
NOTE: be careful to cover the entire accordion.

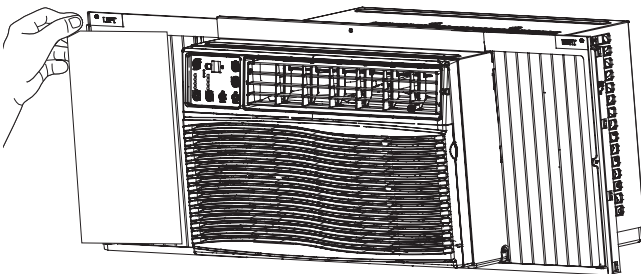

Through-the-Wall Installation Instructions—Optional

The case may be installed through-the-wall in both existing and new construction.

Read completely, then follow step-by-step.

NOTE: Obtain all materials locally for mounting the air conditioner through-the-wall.

1 IMPORTANT

Through-the-wall installation is not appropriate if any of the side or top louvers in the case will be obstructed by the wall.

All side and top louvers in the case must project on the outdoor side of the wall.

The room side of the case must project into the room far enough to maximize the balance of the unit.

The case must be installed level from side-to-side and with a slight tilt from front to rear. Use a level; no more than a 1/2 bubble will be the correct case slant to the outside.

Lintel angle is required to support bricks or blocks above opening.

Flashing is required and should extend the length of the opening to ensure no inside cavity leakage occurs.

- A** Remove the air conditioner from the case. For specific instruction, refer to the Window Installation Instructions.
- B** Make certain that a wall receptacle is available close to the hole location or make arrangements to install a receptacle.

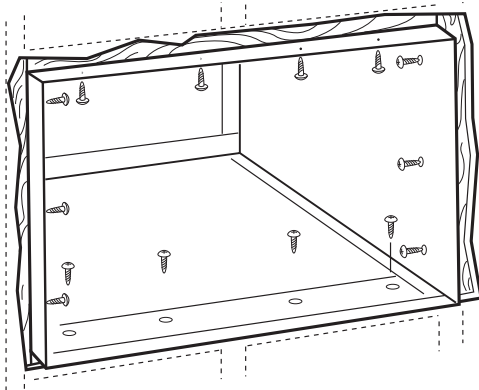

- C** Place the case in the wall opening and place wood support strips between the case bottom and the flashing on both sides of the bottom rail. They should be the same height as the bottom rail and the same length as the wall opening.

1 IMPORTANT (cont.)

- D** Secure with 14 wood screws anchored at least an inch into the wall support structure.

NOTE: Drill pilot holes, if necessary, for proper installation. If the frame is oversized, use shims to prevent case distortion.

2 FINISH THE WALL OPENING

- A** Caulk all four sides on the outdoor side of the case to prevent moisture from getting through to the interior wall. Use of flashing (drip rail) will further prevent water from dripping inside the wall and down the outside of the building.

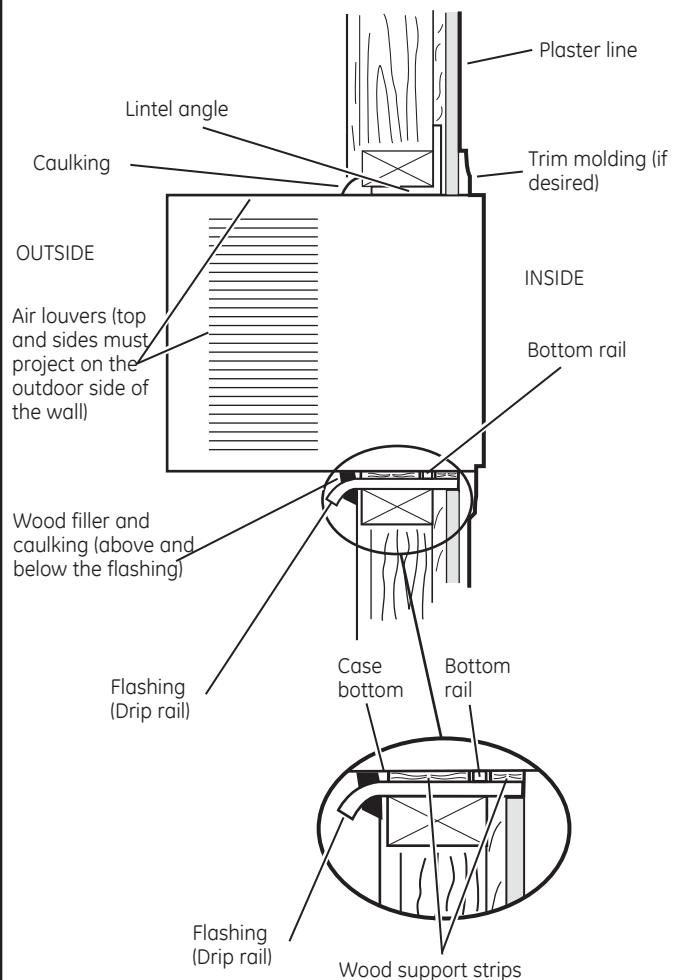

- B** Place the air conditioner into the case. For specific instruction, refer to the Window Installation Instructions.