

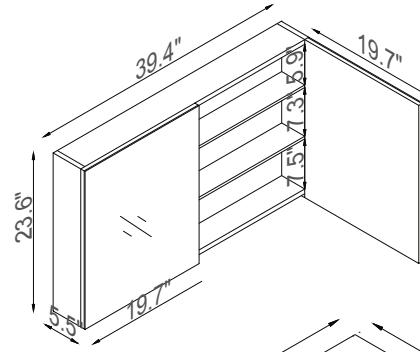

Streamline

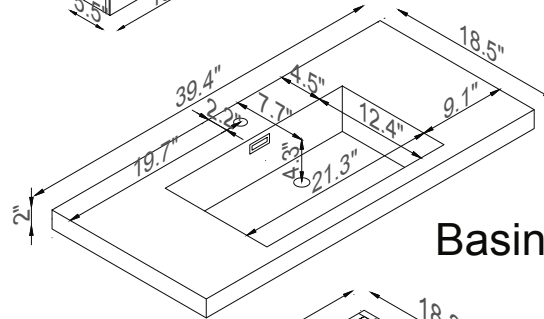

Med. Cab.



Basin

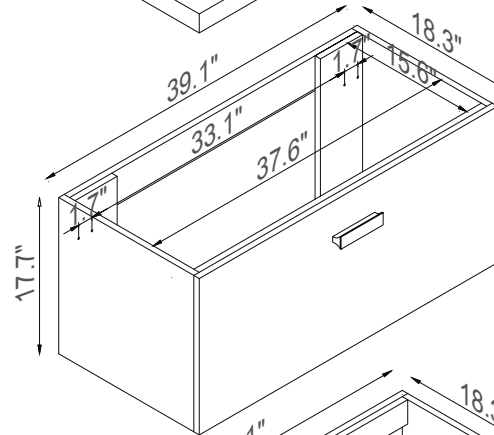

Master Cabinet

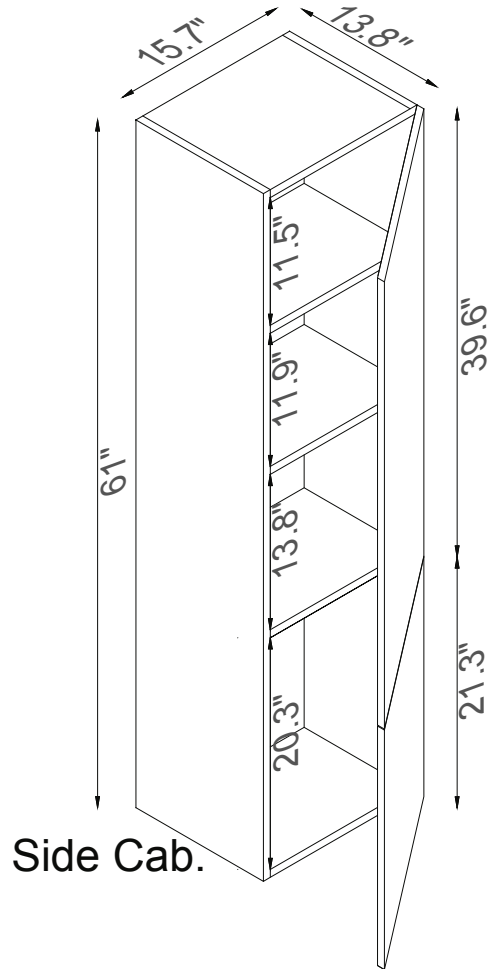
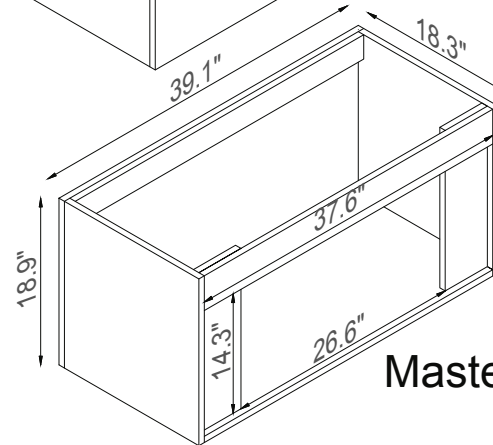

Side Cab.

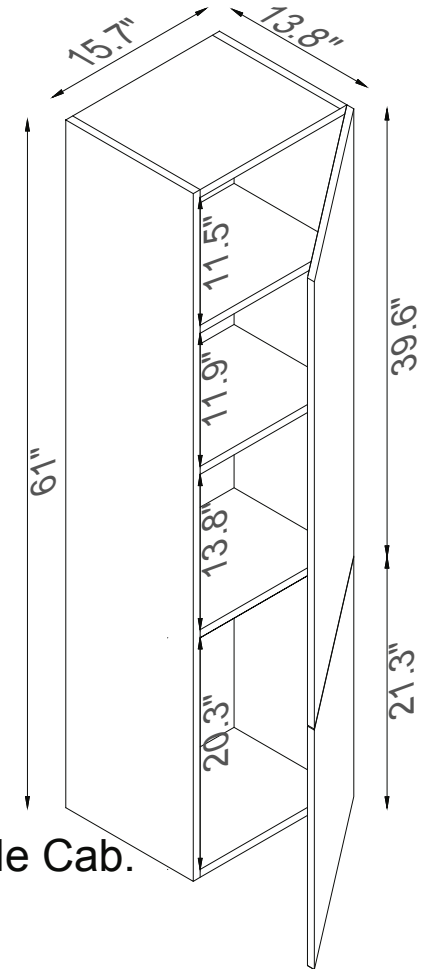

Side Cab.

K1801-140-40-51MR2S