



MILLENNIUM SERIES

OWNER'S MANUAL & INSTALLATION GUIDE

Installer: This booklet must be given to the product owner. Please add important information below.

Model # _____ Purchase Date _____

Serial # _____ Distributor _____

Note: Read all instructions before proceeding with installation.
All specifications are $\pm 3/8''$ and are subject to change without notice. Dimensions listed in inches (mm).



TABLE OF CONTENTS

PRODUCT WARRANTY REGISTRATION INFORMATION	3
IMPORTANT SAFETY INSTRUCTIONS	4 – 5
USER INFORMATION	6
FCC INFORMATION	6
AQUATIC LIMITED LIFETIME WARRANTY	7
INSTALLATION INSTRUCTIONS	
Pre-Installation Procedures	8
Structural Preparation	9
Fast-Fill Waterfall Spout	10
Plumbing	10
Electrical Installation	11 – 13
Inline Maintenance Heater Wiring and Operating Instructions	14
Final System Test & Clean-Up	15
OPERATION	
Bathside Control Systems	16 – 18
Jet Operations	19 – 20
Dual Sided Remote Control Installation	21 – 22
TUB CARE	
Maintenance	23 – 24
Repair	24
WATER QUALITY	
Chemical and Water Quality	25 – 26
TROUBLESHOOTING GUIDE	27
REPLACEMENT PARTS LIST	28 – 29
REPLACEMENT PARTS MAPS	30 – 33

AQUATIC

Product Warranty Registration Information

Thank you for choosing an Aquatic bath. You have chosen one of the finest bath products in the industry! Aquatic supports your purchase with strong commitments to quality and customer satisfaction.

IMPORTANT!

To activate Product Warranty please register with Aquatic. Your product warranty must be registered and confirmed with Aquatic through the Serial Number on your unit. To register, please contact Aquatic.

(800) 945-2726 • www.aquaticbath.com/register

Please read and follow all of the instructions contained in this Owner's Manual before installing, operating or maintaining your bath. In addition, you should continually refer to these instructions during the life of your bath. Failure to comply with these instructions may invalidate your warranty. If you have any questions concerning installation, operation, maintenance or any other aspect of your Aquatic bath, please contact:

AQUATIC CUSTOMER SERVICE CENTER: (800) 945-2726

(The Troubleshooting Guide on page 27 may be helpful in answering some of your questions.)

NOTE: The installation and service of your Bath should be performed **ONLY** by a qualified electrician and plumber.

IMPORTANT!

This product **MUST BE WATER-TESTED** and inspected prior to installation or warranty will be voided. [See **TO INSPECT** on page 8.] Neither Aquatic nor the distributor will be responsible for removal or reinstallation costs should replacement of the bath be necessary.

PLEASE CHECK ENTIRE UNIT FOR ANY DAMAGE.

If it appears damaged, contact your Aquatic Distributor immediately. Aquatic warranty does not cover damage that occurs in transit.

SERIAL NUMBER LOCATION

The tub model and serial numbers are located above the pump area on the backside of the bathtub. Your installer should have a service access panel in this location.



AQUATIC

Where Inspiration Takes Shape

8101 E. Kaiser Blvd., Suite 200 • Anaheim, CA 92808
(800) 945-2726 • Fax (866) 544-5353
www.aquaticbath.com

IMPORTANT SAFETY INSTRUCTIONS

WARNING: When using this unit, basic precautions should always be followed. Failure to follow these instructions could result in personal injury, electric shock, or fire.

READ AND FOLLOW ALL INSTRUCTIONS:

- **WARNING:** Risk of lethal electric shock. To reduce risk of electric shock, connect only to circuits protected by a Ground-Fault Circuit Interrupter (GFCI) or Residual Current Device (RCD).
- **DANGER:** To reduce the risk of injury, do not permit children to use this unit unless they are closely supervised at all times.
- Use this unit only for its intended use as described in this manual. Do not use additional attachments and/or equipment not recommended by the manufacturer.
- Never drop or insert any object into any opening.
- The unit must be connected only to a supply circuit that is protected by a Ground-Fault Circuit Interrupter (GFCI). Such a GFCI should be provided by the installer and should be tested on a routine basis. To test the GFCI, push the test button. The GFCI should interrupt power. Push the reset button. Power should be restored. If the GFCI fails to operate in this manner, there is a ground current flowing, indicating the possibility of an electric shock. Do not use this unit. Disconnect the unit and have the problem corrected by a qualified service representative before using.
- To reduce the risk of injury, enter and exit the bath slowly.
- This product is intended for indoor use only. Installing this unit outdoors could cause personal injury and will void your warranty.

SAVE THESE INSTRUCTIONS.

Your safety and the safety of others are very important.

We have provided many important safety messages in this manual and on your appliance. Always read and obey all safety messages.



This is the safety alert symbol. This symbol alerts you to potential hazards that can kill or hurt you and others.

All safety messages will follow the safety alert symbol and either the word "DANGER" or "WARNING." These words mean:

DANGER

You can be killed or seriously injured if you don't immediately follow instructions.

WARNING

All safety messages will tell you what the potential hazard is, tell you how to reduce the chance of injury, and tell you what can happen if the instructions are not followed.

IMPORTANT SAFETY INSTRUCTIONS

WARNING: WHEN USING THIS UNIT, THESE BASIC PRECAUTIONS SHOULD BE FOLLOWED.

This manual contains information and instructions for proper operation and maintenance of your bath. Failure to follow these instructions could result in personal injury, electrical shock or fire.

READ AND FOLLOW ALL INSTRUCTIONS

DANGER! TO REDUCE THE RISK OF INJURY:

1. Do not permit children to use this unit unless they are closely supervised by an adult at all times. Supervision is also required when your bath is used by an elderly or handicapped individual.
2. Use this unit only for its intended use as described in this manual. Do not use attachments not recommended by the manufacturer.
3. Do not operate this unit without guard over the suction fitting.
4. The water in a air-whirlpool should never exceed 40°C (104°F). Water temperatures between 38°C (100°F) and 40°C (104°F) are considered safe for a healthy adult. Use time should be limited to approximately 30 minutes, followed by a shower to cool down. Longer exposures may result in hyperthermia. The symptoms of this condition are nausea, dizziness and fainting, which can be fatal. Lower water temperatures are recommended for extended use (exceeding 10-15 minutes) and for young children.
5. Since excessive water temperatures have a high potential for causing fetal damage during the early months of pregnancy, pregnant or possibly pregnant women should limit air-whirlpool water temperatures to 38°C (100°F).
6. The use of drugs or alcoholic beverages before or during air-whirlpool use may lead to unconsciousness with the possibility of drowning. Never use the air-whirlpool while under the influence of alcohol, anticoagulants, stimulants, antihistamines, vasoconstrictors, vasodilators, hypnotics, narcotics or tranquilizers.
7. Persons with a medical history of heart disease, low or high blood pressure, circulatory system problems, or diabetes should consult a physician before using a air-whirlpool.
8. Persons using medication should consult a physician before using a air-whirlpool since medication may induce drowsiness while other medication may affect heart rate, blood pressure and circulation.

DANGER: To reduce the risk of injury, enter and exit the bath slowly.

WARNING: Never operate electrically connected devices in or near the bath. Never drop or insert any object into any opening within the air-whirlpool.

This unit must be connected to a supply circuit that is protected by a Ground Fault Circuit Interrupter (GFCI). Such a device should be installed by a licensed electrician and should be tested on a regular basis (at least monthly). To test the GFCI push the TEST function. The GFCI should interrupt the power. Push the RESET function and the power should be restored. If the GFCI fails to operate in this manner there is the possibility of an electric shock. **DO NOT USE.** Disconnect the unit and have the problem corrected by a qualified service technician. To avoid the possibility of personal injury and discoloration of the acrylic surface, the inlet water temperature should not exceed 60°C (140°F). The bath should be drained after each use. Each bather should start their bath with fresh water.

CAUTION: DO NOT USE HARSH ABRASIVES OR SOLVENTS FOR CLEANING THIS UNIT.

installer/owner bears all responsibility to comply with all state and local codes when installing this product.

SAVE THESE INSTRUCTIONS

USER INFORMATION PLEASE NOTE:

The whirlpool action may cause even small amounts of bubble bath or shampoo to foam excessively. Exercise moderation in experimenting with different soap products.

No servicing of this product should be done by the user. There are no user serviceable parts. All controls are located in the control recesses on the lip of the tub. These are the only controls that should be used by the consumer. Do not change or alter any of these controls under any circumstances.

Motors are self-lubricating - No lubrication required.

FCC CONSUMER INFORMATION

Electrical Installation Information Starting on Page 11.

This equipment generates and uses radio frequency energy and if not installed and used properly, that is, in strict accordance with the manufacturers instruction, may cause interference to radio and television reception. It has been type tested and found to comply with the limits for a class B computing device in accordance with the specifications in subpart J of part 15 of the FCC rules, which are designed to provide reasonable protection against such interference in a residential installation. However, there is no guarantee that interference will not occur in a particular installation. If this equipment does cause interference, which can be determined by turning the equipment on and off, the user is encouraged to try to correct the interference by one or more of the following measures:

- Reorient the receiving antenna.
- Relocate the receiver with respect to the bath tub.
- Move the receiver away from the bath.
- Plug the receiver into a different outlet so that the receiver and bath are on different branch circuits.
- If necessary, the user should consult the dealer or an experienced radio/television technician for additional suggestions.
- The user may find the following booklet prepared by the FCC helpful: "How To Identify and Resolve Radio-TV Interference Problems." It is available from the U.S. Government Printing Office, Washington, DC 20402, Stock No., 004-000-00345-4.



Aquatic Limited Lifetime Warranty

FOR MILLENNIUM SERIES BATHS

LIMITED WARRANTY FOR ORIGINAL CONSUMER FOR HOUSEHOLD USAGE

WHAT PRODUCTS ARE COVERED

Structures and surface finishes, pumps and blowers on the Millennium Series.

Warranty Periods for Specific Components

LIFETIME WARRANTY FOR WHIRLPOOL/AIR BATH/TUB SHELL, PUMP AND BLOWER

Aquatic extends to the original consumer purchaser of the acrylic, fiberglass reinforced shell, a non-transferable lifetime warranty that the shell will retain its structural integrity and configuration and be free of water loss due to a defect in the tub shell. The warranty covers the tub shell and the factory installed pump and blower against defects in material or workmanship. This warranty does not apply to all other components (attachments to the acrylic, fiberglass reinforced shell, such as plumbing, fittings and other apparatus) because these pieces are covered below under a 2 Year Warranty.

LIFETIME SURFACE WARRANTY FOR FACE OF WHIRLPOOL/AIR BATH/TUB

The interior surface is warranted against fading, blistering, cracking and delamination due to defects in the surface materials for life. This surface warranty extends to defects due to surface material mixing or molding. This surface warranty does not apply to fading, cracking, delamination or blistering due to *excessive wear, sun fading or scouring due to cleaning.*

2 YEAR EQUIPMENT WARRANTY FOR SUPPORT EQUIPMENT, COMPONENTS, CONTROLS & PLUMBING EQUIPMENT

All support equipment; components, controls and plumbing equipment are warranted for 2 years from date of purchase, but not more than 3 years from date of manufacture, against defects in workmanship and materials. Light bulbs, fuses and pillows are not included in this two-year period. However, these accessories are warranted to be free from defects in materials and workmanship at the time of delivery to the original purchaser. Limited labor is covered for 2 years from purchase, but never more than 3 years from date of manufacture, for limited labor on the support equipment, controls, and plumbing.

EXCLUSIVE REMEDY

Aquatic will, **at its option**, repair or replace (without removal or installation) the affected components of any defective Unit or System; repair or replace (without removal or installation) the entire defective Unit or System; or refund the then-current list price of the Whirlpool, Air Bath, or Tub. In all cases, a reasonable time period must be allowed for warranty repairs to be completed.

WHAT YOU MUST DO

In order to make a claim under these warranties:

1. You must be the original consumer purchaser of the Whirlpool, Air Bath, or Tub.
2. You must promptly notify us within the warranty period of any defect and provide us with any substantiation that we may reasonably request.
Write to: **Aquatic 1521 N. Cooper, Ste. 500 Arlington, TX 76011.**
3. The Whirlpools, Air Baths, and Tubs must have been installed and maintained in accordance with good industry practice and the specific Aquatic directions contained in the Owner's Manual and Installation Guide.

EXCLUSIONS

These warranties do **not** extend to or do **not** cover defects caused by:

1. Shipping damage by carriers or installation errors.
2. Accident, acts of God, abuse or misuse.
3. Unreasonable use (including any use for non-bathing purposes or failure to provide reasonable and necessary maintenance as specified in Aquatic Owner's Manual and Installation Guide supplied with the Whirlpool, Air Bath or Tub).
4. Any alteration, customization, or modification of the Whirlpool/Air Bath/Tub or its components.

LIMITATIONS

1. **Aquatic whirlpools and tubs sold for industrial, commercial and hotel use** are warranted for two years, but not more than 3 years from date of manufacture, with a 2 year limited warranty that the shell will retain its structural integrity and configuration and be free of water loss due to a defect in the tub. The interior surface/face of the whirlpool/air bath/tub is warranted against fading, blistering, cracking and delamination due to defects in the surface materials for 2 years as well. All support equipment, components, controls and plumbing equipment and limited labor on the support equipment, controls, or plumbing are warranted for 1 year from date of purchase, but not more than 2 years from date of manufacture. Pump seals, "O" rings, light bulbs, fuses and pillows are not included in this two-year period. However, these accessories are warranted to be free from defects in materials and workmanship at the time of delivery to the original purchaser.
2. **In all cases, Aquatic reserves the right to fully satisfy its obligations under the Limited Warranties by refunding the then-current list price of the defective Whirlpool, Air Bath, or Tub (or, if the Whirlpool, Air Bath, or Tub has been discontinued, of the most nearly comparable current product).**
3. **THESE WARRANTIES ARE NON-TRANSFERABLE TO ANY OTHER PURCHASER OR PARTY OTHER THAN THE ORIGINAL CONSUMER. NO OTHER AGENT OR PARTY CAN GIVE ANY OTHER WARRANTY OR PROMISE. THIS IS THE SOLE WARRANTY FOR YOUR Aquatic PRODUCT.**
4. Aquatic will not cover any installation or reinstallation costs related to this warranty, except under the limited labor allowance under the 2 Year Equipment Warranty above.

GENERAL

This warranty gives you specific legal rights; you may also have other rights, which vary from state to state. THE DURATION OF ANY IMPLIED WARRANTIES, INCLUDING THE IMPLIED WARRANTIES OF MERCHANTABILITY AND FITNESS FOR A PARTICULAR PURPOSE, ARE LIMITED TO THE DURATION OF THE EXPRESS WARRANTIES HEREIN. Aquatic EXPRESSLY EXCLUDES INCIDENTAL AND CONSEQUENTIAL DAMAGES, TO INCLUDE LOSS OF TIME, INCONVENIENCE, OR LOSS OF USE OF RESIDENCE, FOR ANY BREACH OF THE EXPRESS OR IMPLIED WARRANTY, INCLUDING THE IMPLIED WARRANTIES OF MERCHANTABILITY OR FITNESS FOR A PARTICULAR PURPOSE.

SOME STATES DO NOT ALLOW ANY LIMITATION ON HOW LONG AN IMPLIED WARRANTY LASTS, OR THE EXCLUSION OR LIMITATION OF INCIDENTAL OR CONSEQUENTIAL DAMAGES; SO THE ABOVE EXCLUSION MAY NOT APPLY TO YOU.

INSTALLATION INSTRUCTIONS

READ ALL INSTRUCTIONS CAREFULLY BEFORE INSTALLATION

PRE-INSTALLATION PROCEDURES

PLEASE NOTE: THE MANUFACTURER ACCEPTS A $\pm 3/8"$ VARIANCE. THERE ARE VARIATIONS ON EACH TUB AND SPECIFICATIONS ARE SUBJECT TO CHANGE AS WE IMPROVE UPON OUR PRODUCT AS REQUIRED.

THE DIMENSIONS NEEDED FOR SITE PREPARATION AND STRUCTURE BUILDINGS SHOULD BE MEASURED FROM THE TUB; AQUATIC, ASSUMES NO RESPONSIBILITY FOR PREPARATORY WORK.

Note: A good knowledge of construction techniques, plumbing and electrical installation according to codes are required for proper installation. We recommend that a qualified licensed contractor perform the installation of all Aquatic products. Our warranty does not cover improper installation related problems.

1. Immediately upon receiving your Aquatic air-whirlpool bath, inspect it thoroughly for freight damage. If necessary, contact your dealer/distributor immediately (your dealer/distributor must contact Aquatic, within 24 hours of receiving unit to file a claim.) Should inspection indicate any damage, do not install the bath.
2. All baths are filled with water and operated in our manufacturing facility prior to shipment. Inspectors ensure watertight operation, however, rough handling may cause leaks which may be detected prior to installation.

DAMAGE OR DEFECT TO THE FINISH CLAIMED AFTER THE BATH IS INSTALLED IS NOT COVERED UNDER THE WARRANTY.

To inspect:

1. Place the tub in an area where it may be drained after testing.
2. Fill the tub with water to the overflow and allow to stand for a few minutes. Carefully inspect all fittings and connections for leaks. Should inspection indicate any damage, do not install the bath.
3. After connecting the (2) 240vac, 4 four wire circuits to junction boxes, run both pumps for 10 minutes and both blowers for 10 minutes. With the pump running, turn on the blower. Check all functions. Inspect the tub completely. Any defect must be reported to Aquatic prior to installation in order to have it covered by warranty. Should inspection indicate any damage, contact Aquatic immediately.
4. Check to ensure that your installation will conform to all applicable codes and secure necessary permits. All electrical and plumbing connections should be made by qualified electricians and plumbers.

DAMAGE OR LEAKS CLAIMED AFTER THE BATH IS INSTALLED ARE NOT COVERED UNDER THE WARRANTY.

WARNING: FAILURE TO FOLLOW THESE INSTRUCTIONS DURING INSTALLATION WILL RESULT IN TERMINATION OF THE WARRANTY:

Do not lift the tub by any portion of the plumbing or pump.
Do not stand in the tub during construction.

DO NOT MAKE ANY ALTERATIONS, ADDITIONS, OR DELETIONS TO THE WHIRLPOOL SYSTEM, PUMP, BLOWER OR BATH.

WARNING: Whirlpool blower, pump and piping are factory assembled. Relocation of blower, pump or other modifications could adversely affect the performance and safe operation of this air-whirlpool. Aquatic, shall not be liable under its warranty or otherwise for personal injury or damage caused by any such unauthorized modification.

QUIETNESS OF OPERATION: Aquatic has engineered their air-whirlpool baths from base to lip to ensure quality, value, functional design, and maximum bathing comfort. However, installation is accountable for as much as 50% of a tub's operating quietness. Please ensure the following:

- The floor structure is adequate to support the installation.
- For quieter operation and heat retention conservation, the walls surrounding the air-whirlpool may be insulated.
- Insulate the tub surround. Do not allow any insulation to come within 3 feet of the blower and pump. The area around the blower and pump must be clean and free of any foreign matter.
- Leave 1/8" to 3/16" gap between tub lip and surround.

INSTALLATION INSTRUCTIONS

STRUCTURAL PREPARATION

Note: The bath should remain in its shipping carton until time of installation.

- Literature dimensions are for reference only. **INSTALLATION DIMENSIONS SHOULD BE TAKEN DIRECTLY FROM THE TUB.**

2X access panels of at least 16" x 16"

- Millennium 7 (See Figure A)
- Millennium 8 (See Figure B)
- Millennium 9 (See Figure C)
- Millennium 10* (See Figure D)
- *Needs two access panels

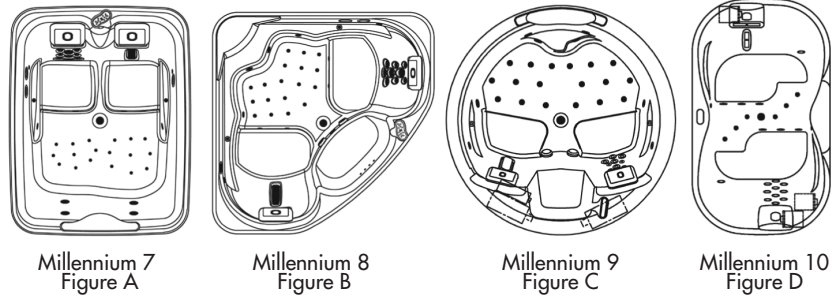

IT IS THE INSTALLER'S RESPONSIBILITY TO PROVIDE SUFFICIENT SERVICE ACCESS AND TO ENSURE THAT ACCESS PANELS AND/OR SERVICE OPENINGS ARE PROPERLY PLACED AND ACCESSIBLE.

- Install the drain fitting to the bath. **THE DRAIN FITTING MAY PROTRUDE BELOW THE BASE OF THE TUB.** Clearance must be provided for the drain by cutting away the subfloor (where possible) or by blocking below the tub as may be required. **WARNING:** All blocking must be solid and provide uniform support to the tub base.
- Tub must rest entirely on all leveling feet. **DO NOT SUPPORT THE WEIGHT OF THE TUB BY THE RIM.** Lift unit and place into framework. If necessary, adjust feet until unit is completely touching on the leveled sub floor. Secure the unit by fastening the bottom feet to the sub floor with any construction adhesive caulk or screw the feet to the floor. For quieter operation and heat conservation, the walls surrounding the air-whirlpool may be insulated.
- Frame out under the tub rim as shown in one of the illustrations below. **NOTE:** Due to the variety of installations possible, framing procedures other than those described may be required. Plumb in selected location using a level. Level front to back and across both sides. A ledge under the rim, or an apron without a ledge, may be constructed as required (see Figures 1A, 1B and 1C). Where installation will be against a wall, stud wall framing should allow for wall sheathing material to run full length to the floor (see Figure 1D). Install tub firmly against sheathing as indicated, with blocking below rim to prevent deflection or movement of tub. To prevent a rocking movement of tub after installation, it is important to have rim in contact, but not supported by blocking material.
- When placing the tub on a platform or cut out (see Figures 1A, 1B and 1E), the opening should be 1" smaller than the specified rim dimensions. Extreme care must be taken in this type of installation to ensure the tub will come to rest entirely on the leveling feet.

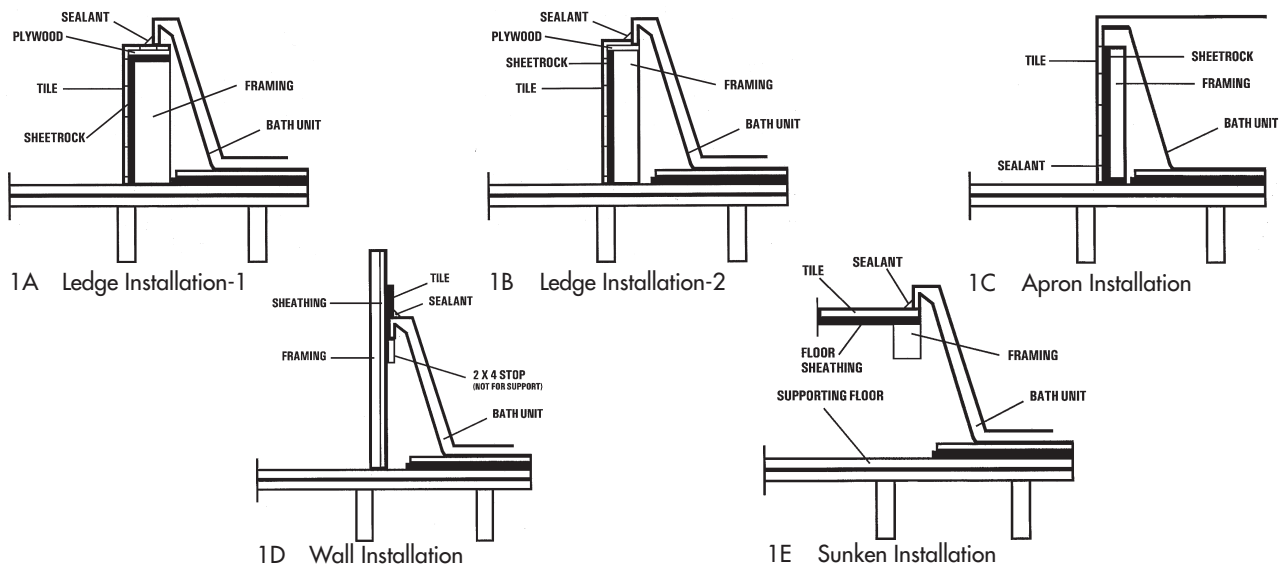

WARNING: ALL ELECTRICAL CONNECTIONS SHOULD BE MADE BY A LOCALLY LICENSED ELECTRICIAN/TECHNICIAN.

INSTALLATION INSTRUCTIONS

FAST-FILL WATERFALL SPOUT

The Fast-Fill Waterfall Spout will be stubbed as in Figure 2B.

WARNING: DO NOT OVER TIGHTEN! DO NOT USE TEFLON TAPE.

Damage to fitting is not covered under warranty.

2A



FROM VALVES

Fast-Fill Waterfall Spout is stubbed out with a 3/4" female threaded brass fitting.

2B

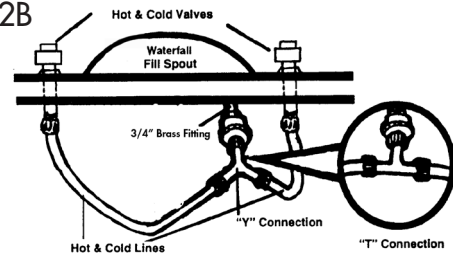

PLUMBING

1. After securing bath in place, normal waste and overflow and valves are installed per normal plumbing procedures, in accordance with all state and local standards.
2. Install standard 1-1/2" trap to drain and overflow. Before proceeding make final operational check by filling tub with water to overflow and operate pumps for 5 minutes. Check for leaks carefully both while pump is running and has been turned off. Allow water to stand in tub for at least 30 minutes before draining. **AQUATIC WILL NOT BE RESPONSIBLE FOR WATER DAMAGE OF ANY KIND IN CONNECTION WITH ONE OF OUR AIR-WHIRLPOOL BATHS.** Aquatic recommends the use of 3/4" valves.
3. All Millennium Series models are equipped with an integral Fast-Fill Waterfall Spout (unless ordered without this feature). Purchasing a spout is unnecessary, however, hot and cold water valves are needed. Valves can be mounted where you choose, however, if installation is to be on tub deck, check the back side of the tub for adequate space for connection to water lines before drilling or cutting tub.

NOTE: For Rough-in measurements please refer to unit's technical data sheet.

INSTALLATION INSTRUCTIONS

NOTE: BEFORE BATH IS USED, THE AIR-WHIRLPOOL SYSTEM SHOULD BE CLEANED IN ACCORDANCE WITH THE PROCEDURES ON PAGE 23 OF THIS MANUAL.

ELECTRICAL INSTALLATION

WARNING: ALL ELECTRICAL CONNECTIONS MUST BE MADE BY A LICENSED, LOCALLY CERTIFIED ELECTRICIAN, IN ACCORDANCE WITH THE REQUIREMENTS OF THE NATIONAL ELECTRICAL CODES AND PROCEDURES.

WARNING: WHEN USING ELECTRICAL PRODUCTS, BASIC PRECAUTIONS SHOULD ALWAYS BE FOLLOWED, INCLUDING THE FOLLOWING.

DANGER: RISK OF ELECTRIC SHOCK! Connect only to circuits protected by a Ground Fault Circuit Interrupter (GFCI). A GFCI is not supplied, however, we do specify its use. All known code authorities require a GFCI.

Rough-in wiring to junction boxes: Two 240V, 4 wire, 50 AMP GFCI protected circuit.

See electrical schematics for junction boxes on pages 12 and 13 .

Bonding wire: Connect a #8 bare copper bonding wire from the pump motor or motors and heater to the cold water plumbing or other suitable ground. Grounding is required. The unit should be installed by a qualified electrician and grounded as specified above.

For built-in and custom units, install to permit access for servicing.

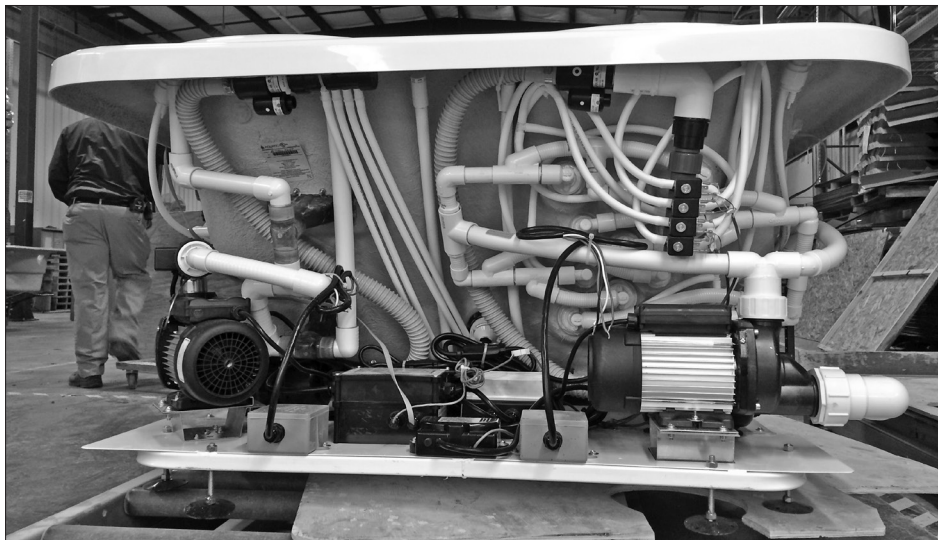

INSTALLATION INSTRUCTIONS

ELECTRICAL INSTALLATION (CONT.)

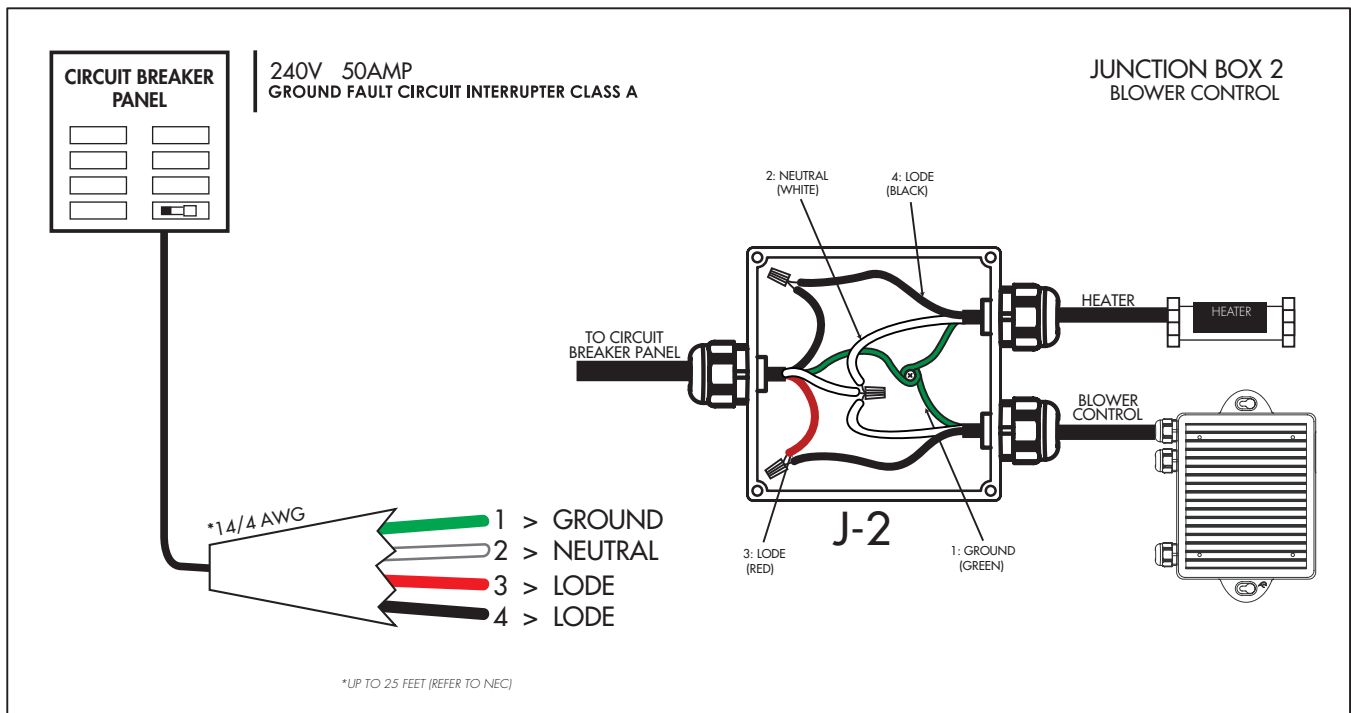
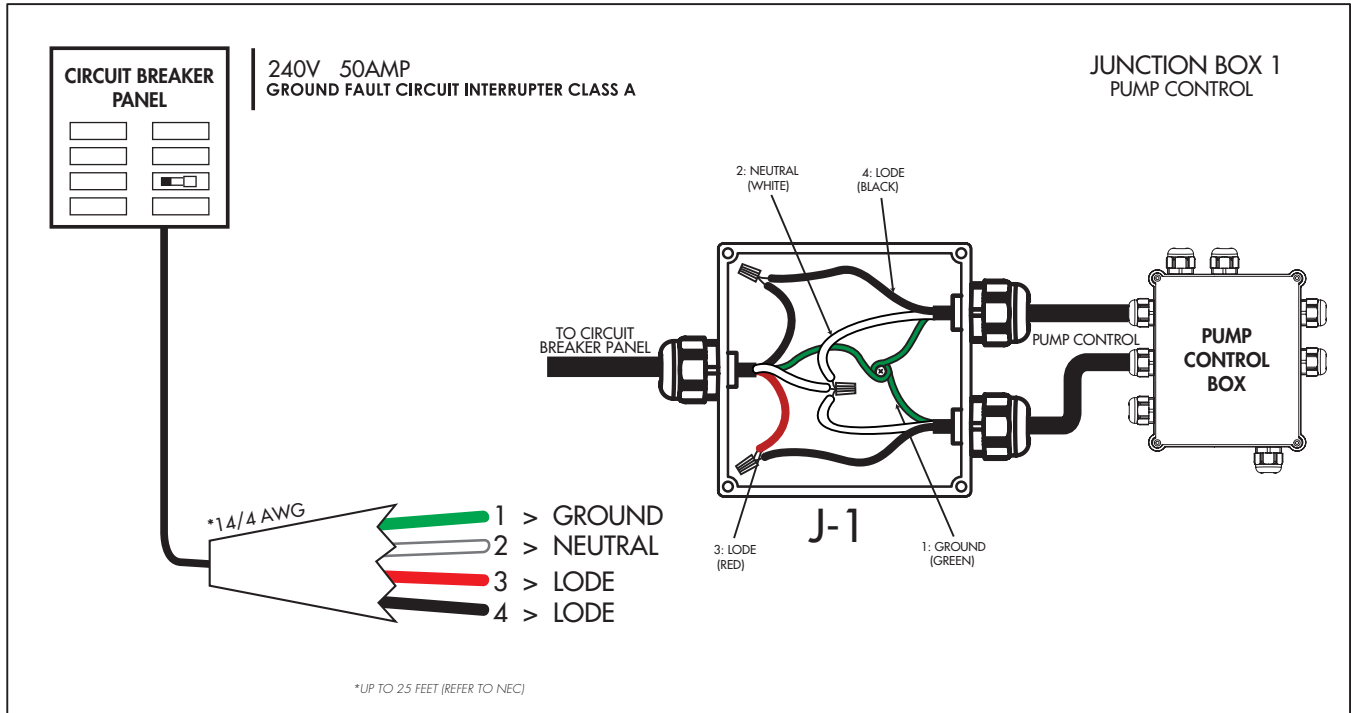

INSTALLATION INSTRUCTIONS

ELECTRICAL INSTALLATION (CONT.)

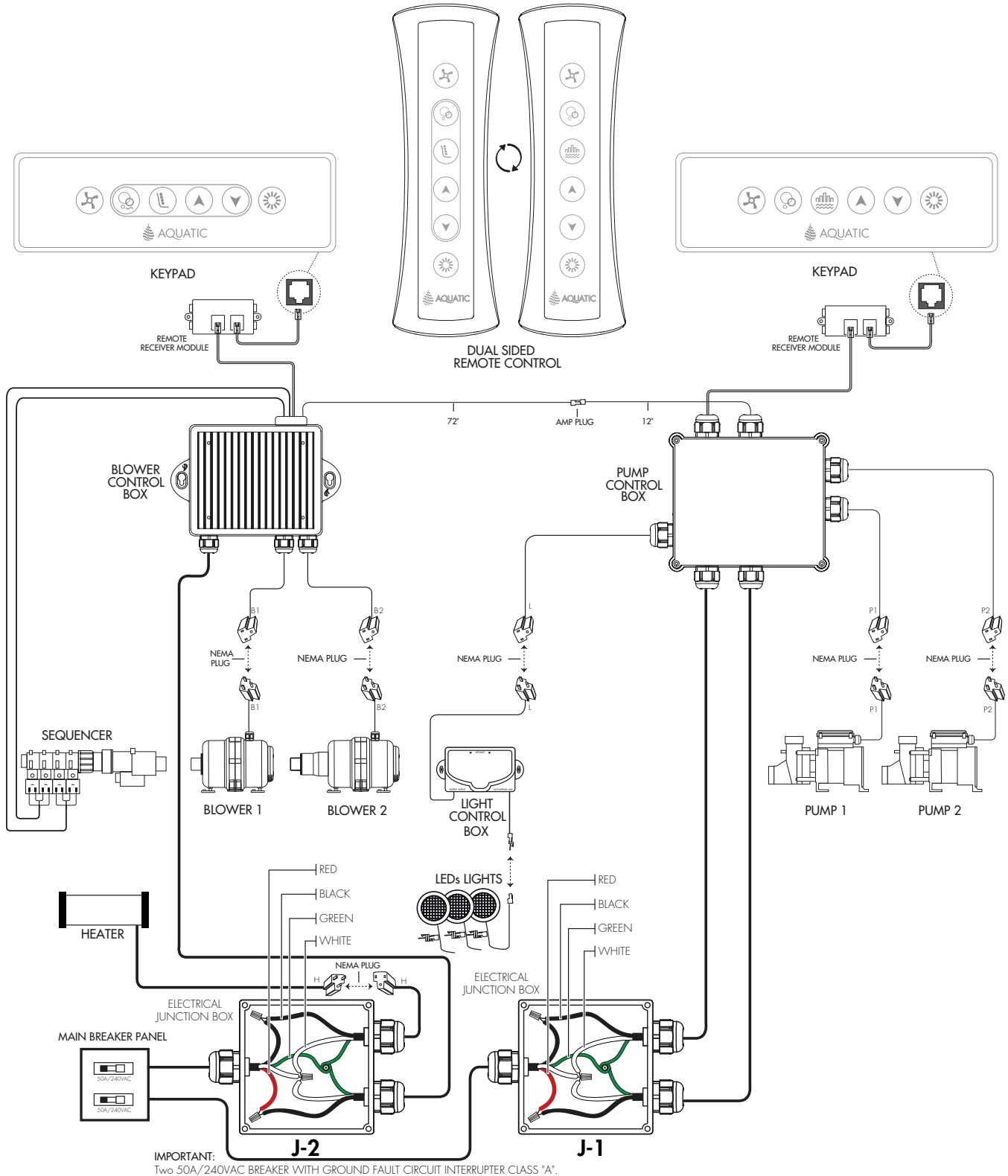

INSTALLATION INSTRUCTIONS

INLINE MAINTENANCE HEATER WIRING AND OPERATING INSTRUCTIONS

The air-whirlpool Inline Maintenance Heater is totally self-contained to ensure trouble free operation. The heater will maintain the temperature of the water in the bathtub. As with all electrical devices, certain safety precautions should be taken during wiring and use. Please read and follow all these instructions carefully.

FEATURES OF THE INLINE MAINTENANCE HEATER

HI-LIMIT: The heater includes an exclusive "Smart Hi-Limit." This Hi-Limit will not "false trip" from hot tap water. It will only turn heater off if the thermostat fails.

POWER INDICATOR: This illuminating light plug turns on when heater is plugged into a power outlet.

SAFETY FEATURES: In addition to the thermostat and Hi-Limit, the heater is equipped with a built-in pressure switch. This switch will not allow the heater to turn on if the pump is not running.

WARNING: RISK OF ELECTROCUTION! All electrical connections must be performed by a licensed electrician in compliance with local and national electrical codes. In addition, a GFCI **MUST** protect all branch circuits to the whirlpool.

1. Two 240V, 4 wire, 50 AMP GFCI protected circuit.
2. Use copper conductors only.
3. Insure the heater and pumps are properly **GROUND**ED and pump is **BONDED** as required.

CAUTION: Before use of the blowers, pumps and heater, test the GFCI for proper operation. The blowers, pumps and heater should turn off when the GFCI "Test" function is pushed.

WARNING: Prolonged Immersions in Hotter Water May Induce Hyperthermia.

Hyperthermia occurs when the internal temperature of the body reaches a level several degrees above the normal body temperature of 98.6°F. The symptoms of hyperthermia include an increase in the internal temperature of the body, dizziness, lethargy, drowsiness, and fainting. The effects of hyperthermia include (1) failure to perceive heat, (2) failure to recognize the need to exit the whirlpool, (3) unawareness of impending hazard, (4) fetal damage in pregnant women, (5) physical inability to exit the whirlpool, (6) unconsciousness resulting in the danger of drowning.

WARNING: The use of alcohol, drugs, or medication can greatly increase the risk of fatal hyperthermia.

INSTALLATION INSTRUCTIONS

FINAL SYSTEM TEST & CLEAN-UP

System Test

To test system, follow these steps in order listed:

1. Fill clean tub with water to a point no less than 2" (50) above the highest jet.
2. To test the Ground-Fault Circuit-Interrupter (GFCI), push the test button. The GFCI should interrupt power. Push the reset button. Power should be resorted. If the GFCI fails to operate in this manner, there is a ground current flowing, indicating the possibility of an electric shock. Do not use this unit. Disconnect the unit and have the problem corrected by a licensed electrician before using.
3. Push on/off button on the whirlpool.
4. Allow system to run a full 10 minutes.
5. Through access door or removable skirt, check for leaks in air-whirlpool plumbing system. Make sure half-unions at both ends of pump are hand-tight. If leakage is occurring at any other points, notify distributor.
6. If any electrical malfunctions occur, immediately unplug the unit and consult a licensed electrician. Malfunctions of the pump/blower/motor, whirlpool controls or the circulating system should be reported to the distributor who supplied the air-whirlpool tub.

Clean-up

1. Remove all construction residue and foreign materials. Wipe unit clean with a damp rag, otherwise staining may occur.
2. Plaster may be removed by scraping with the edge of a piece of wood or rigid plastic. DO NOT use metal scraper. For spots left by plaster or grout: rub lightly with a liquid detergent (Spic-N-Span® or similar) on a damp cloth or sponge.
3. DO NOT use abrasive cleaners, scouring powders, steel wool, wire brushes or anything else that may harm or dull the surface.
4. Paint, tar or stubborn stains may be removed with paint thinner, turpentine or rubbing alcohol. To avoid discoloration, cleaners containing petroleum distillate must not remain on surfaces. NEVER use lacquer thinner or chlorinated solvents.
5. Dulled areas can be restored to a high gloss with white or cream-colored automotive rubbing compound, followed by application of carnauba wax or white or cream automotive paste wax and buffing.
6. Major gouges require professional repair. Contact Aquatic to arrange factory-authorized repair services.

OPERATION

NOTE: DO NOT START PUMP UNTIL ALL JETS ARE SUBMERGED. WATER LEVEL SHOULD BE 2" ABOVE HIGHEST JET.

BATHSIDE CONTROL SYSTEMS

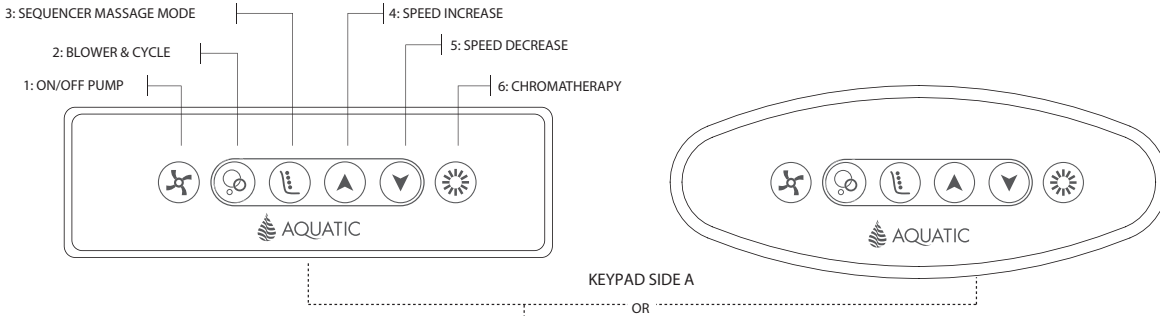

KeyPad A Functions	LED
1: ON/OFF PUMP	
1st Press: The pump starts	ON
2nd Press: The pump stops	OFF
2: BLOWER & CYCLE	
1st Press: Blower starts at high speed.	ON
2nd Press: Wave Cycle - Speed goes gradually from maximum to minimum.	BLINKS
3rd Press: Blower stops	OFF
3: SEQUENCER MESSAGE MODE	
1st Press: Massage Mode A Starts.	ON
2nd Press: Massage Mode B Starts.	BLINKS TWICE follows the speed of the valve
3rd Press: Massage Mode C Starts.	BLINKS 3 TIMES follows the speed of the valve
4th Press: Massage Mode D Starts.	BLINKS 4 TIMES follows the speed of the valve
5th Press: Massage Mode Stops.	OFF
4: SPEED INCREASE	
When the blower is on without the sequencer, press and hold to increase the blower speed. Release pressure at the desired speed. When the sequencer is on, press to increase the speed at which the sequencer operates. Release pressure at the desired speed.	ON When Pressed
5: SPEED DECREASE	
When the blower is on without the sequencer, press and hold to decrease the blower speed. Release pressure at the desired speed. When the sequencer is on, press to decrease the speed at which the sequencer operates. Release pressure at the desired speed.	ON When Pressed
6: CHROMATHERAPY	
1st Press: Turn on the light in white	ON
2nd Press: Rainbow cycle - Low speed	ON
3rd Press: Rainbow cycle - High speed	ON
4th Press: Turquoise	ON
5th Press: Blue	ON
6th Press: Magenta	ON
7th Press: Red	ON
8th Press: Orange	ON
9th Press: Yellow	ON
10th Press: Green	ON
11th Press: Turn off the light Press and hold 2 sec. at anytime to turn off the chromatherapy	OFF
Advanced Programming	
INTEGRATED 20 MINUTE AUTOMATIC TIMER Integrated 20 minute automatic timer on the complete system. Count down starts with the last system turned on. Blower LED will blink until the purge occurs except during the first minute.	
DRYING CYCLE A 1 minute automatic drying cycle will start 20 minutes after the blower is turned off. The blower LED button blinks while waiting for the purge cycle.	

SIDE A of Remote Control has same functionality as KeyPad A

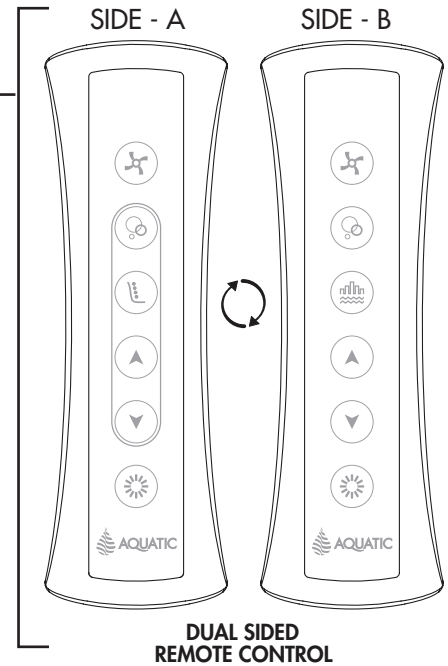

DUAL SIDED REMOTE CONTROL

OPERATION

BATHSIDE CONTROL SYSTEMS (CONT.)

KeyPad A Functions	
SEQUENCER MODE A	The Backjet row shown will be at ON during the cycle: Backjet row 1, 2, 3, 4, 3, 2 and repeats the sequence.
SEQUENCER MODE B	The Backjet row shown will be at ON during the cycle: Backjet row 1-2-1-2 All Off, 1-2-1-2 All Off.
SEQUENCER MODE C	The Backjet row shown will be at ON during the cycle: Backjet row 3-4-3-4 Off, 3-4-3-4 All Off.
SEQUENCER MODE D	The Backjet row shown will be at ON during the cycle: Backjet row All On, All Off.
Advanced Programming	
PRESETS	This mode allows the user to start the tub with his preferred settings with the pres of a button. Up to 4 different presets can be configured.
To Configure the Settings:	<ul style="list-style-type: none"> - Start all desired systems - Adjust the blower/sequencer speed and the light color - Press button 1 for more than 1 second. - LED's 2, 3, 4 and 5 will blink. You have 10 seconds to choose which of the 4 buttons you want your settings saved to. - Press the selected button - LED's of the selected button will blink 3 times to confirm. All systems will stop.
To Select a Preset:	<ul style="list-style-type: none"> - When all accessories are turned off, press the selected button more than 1 second. - The preselected settings will activate.

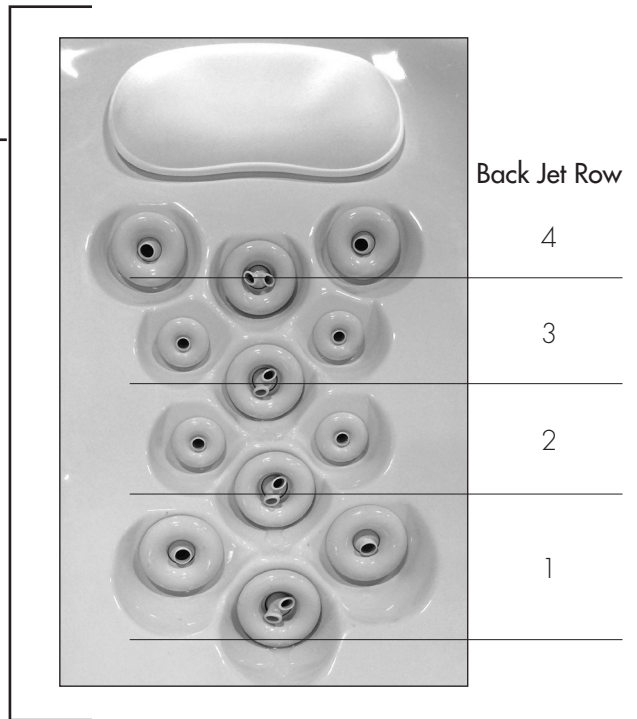

OPERATION

NOTE: DO NOT START PUMP UNTIL ALL JETS ARE SUBMERGED. WATER LEVEL SHOULD BE 2" ABOVE HIGHEST JET.

BATHSIDE CONTROL SYSTEMS (CONT.)

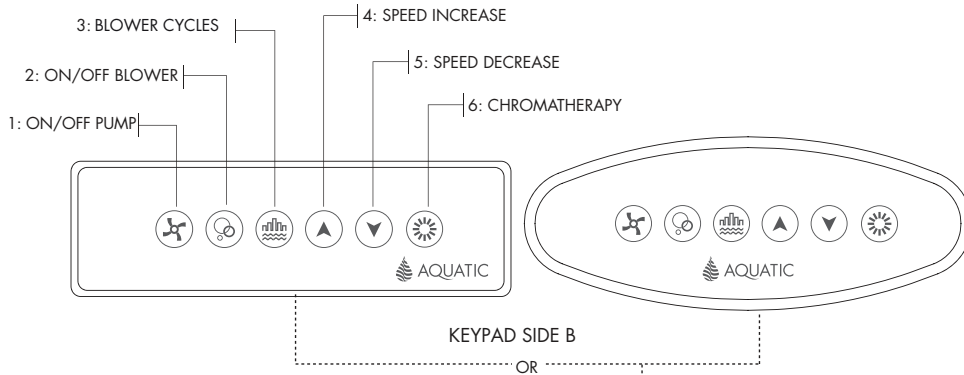

KeyPad B Functions	LED
1: ON/OFF PUMP	
1st Press: The pump starts	ON
2nd Press: The pump stops	OFF
2: ON/OFF BLOWER	
1st Press: The blower starts	ON
2nd Press: The blower stops	OFF
3: BLOWER CYCLES	
1st Press: Wave Cycle - Speed goes gradually from maximum to minimum.	ON
2nd Press: Pulse Cycle - Speed goes from minimum then straight back to maximum.	BLINK
3rd Press: Returns to maximum speed	OFF
4: SPEED INCREASE	
1st Press: Press and hold to increase the blower speed, release pressure at the desired speed. When in cycles mode, increases the speed at which the cycle operates.	ON (WHEN PRESSED)
5: SPEED DECREASE	
1st Press: Press and hold to decrease the blower speed, release pressure at the desired speed. When in cycles mode, decreases the speed at which the cycle operates.	ON (WHEN PRESSED)
6: CHROMATHERAPY	
1st Press: Turn on the light in white	
2nd Press: Rainbow cycle - Low speed	
3rd Press: Rainbow cycle - High speed	
4th Press: Turquoise	
5th Press: Blue	
6th Press: Magenta	
7th Press: Red	
8th Press: Orange	
9th Press: Yellow	
10th Press: Green	
11th Press Turn off the light (Press and hold 2 seconds at any time to turn off the light.)	
Advanced Programming	
DRYING CYCLE WITH WATER DETECTORS	
The drying cycle will activate 20 minutes after the bathtub is emptied even if the system was not used. The blower touch LED blinks while waiting for the purge cycle.	

SIDE B of Remote Control has same functionality as KeyPad B

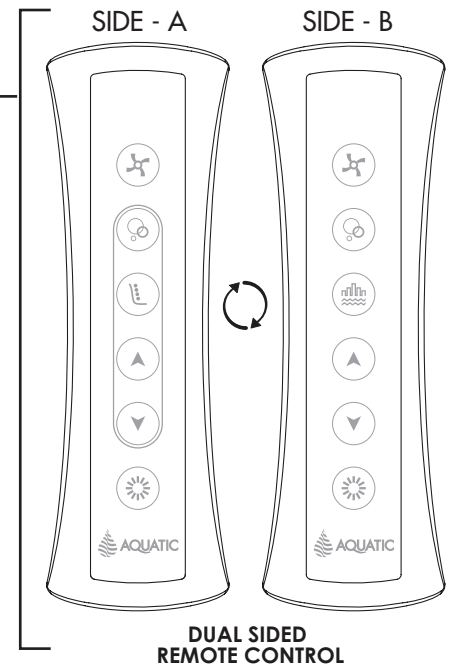

DUAL SIDED REMOTE CONTROL

Figure 9

OPERATION

JET OPERATIONS

All Millennium Series jets are removable and can simply be put into the dishwasher for cleaning.

Note: Use dishwasher top rack and remove before the drying cycle starts.

The Millennium Series features Aquatic's exclusive Shiatsu Back Jetting System, Pressure Plus Jets and Pressure-Flo Hydrotherapy Jets.

Shiatsu Back Jetting System

To adjust pressure (see Figure 3A):

1. Grasp the outer ring of the jet.
2. Turn the jet clockwise to increase flow, counter-clockwise to shut off.

To remove jet (see Figure 3B):

1. Grasp the outer ring of the jet.
2. Turn the jet counter-clockwise, until the jet clicks, then pull.

To replace or change jet (see Figure 3B):

1. Insert the jet into jet housing.
2. Turn the jet clockwise, past point of resistance, until the jet clicks.

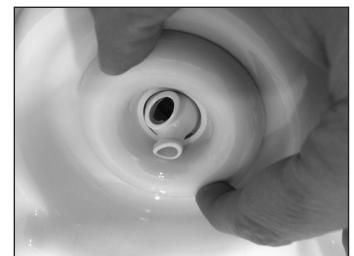

3A



3B

OPERATION

JET OPERATIONS (CONT.)

Pressure Plus Jets

To adjust pressure (see Figure 4A):

1. Grasp the outer ring of the jet.
2. Turn the jet clockwise to increase flow, counter-clockwise to shut off.

To remove jet (see Figure 4B):

1. Grasp the outer ring of the jet.
2. Turn the jet counter-clockwise, until the jet clicks, then pull.

To replace or change jet (see Figure 4B):

1. Insert the jet into jet housing.
2. Turn the jet clockwise, past point of resistance, until the jet clicks.

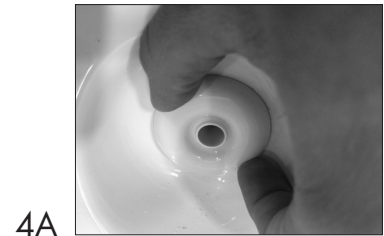

Pressure-Flo Hydrotherapy Jets

For customized hydrotherapy, simply adjust volume of the Pressure-Flo Jet by turning counter clockwise for a gentle flow of air and water or clockwise for stronger massage action. Recessed for greater comfort, the Pressure-Flo Jet targets the hip and leg areas.

To adjust pressure (see Figure 5A):

1. Grasp the outer ring of the jet.
2. Turn the jet clockwise to increase flow, counter-clockwise to shut off.



To adjust direction (see Figure 5B):

1. Using fingertip, move jet eye to desired location.



To remove jet (see Figure 5C):

1. Grasp the outer ring of the jet.
2. Turn the jet counter-clockwise, until the jet clicks, then pull.



To replace or change jet (see Figure 5C):

1. Insert the jet into jet housing.
2. Turn the jet clockwise, past point of resistance, until the jet clicks.

Fan Jet

The Aquatic Fan Jet (see Figure 6) is deeply recessed for greater comfort during bathing. It covers an 8" x 12" area of the body with oscillating streams of air and water, like tiny hands, to massage tired and aching muscles. Operation of this jet is automatic. The Fan Jet is a permanent jet fixture and should not be removed from the tub, but cleaned with a bottle brush and warm, soapy water.



INSTALLATION INSTRUCTIONS

DUAL SIDED REMOTE CONTROL INSTALLATION

Receiver Module Installation

the Receiver Module and remote may be used in conjunction with the supplied keypad or without. The two receiver modules must be installed under the bathtub rim.

IMPORTANT: In order to obtain the best reception possible, we recommend not to install the receiver module next to the faucets or metal piping. Location of the receiver module must be easily accessible from the outside of the bathtub for maintenance.

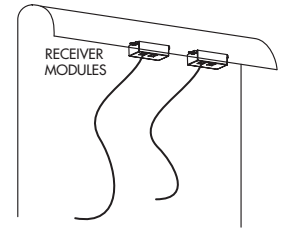

Remote control and keypad used to activate the systems

1. Plug in the cables as shown on the drawing.
2. Once everything is connected, the remote control is ready for synchronization.

Remote control only, to activate the systems

1. Plug in the cables as shown on the drawing.
2. Once everything is connected, the remote control is ready for synchronization.

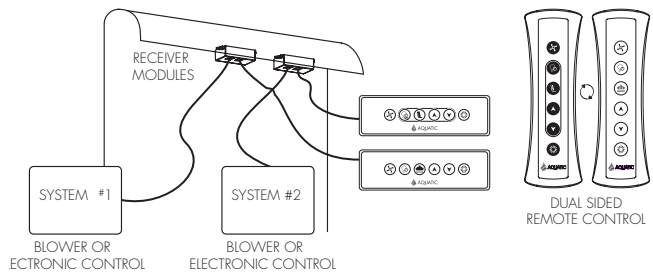

Figure 7A

Synchronization

1. Once the system has been connected, each side of the remote control must be synchronized with its own receiver module.
2. Switch off the main breaker or unplug the two systems and switch it on again one at a time.
3. From this moment, you have 15 seconds to proceed with the synchronization.
4. Press simultaneously on the button 2 and button 3 of the remote for 4 seconds on the side you would like to program.
5. Keeping the first system plugged in, plug in the second system and follow steps 2 – 4.
6. The remote control is now synchronized on both sides and ready to use. Now you should be able to control the two systems independently.
7. If the synchronization is not successful the first time, you should resynchronize, starting from step 2.

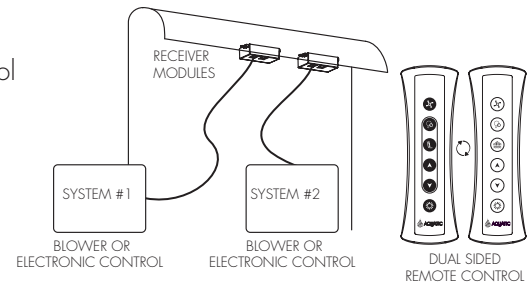
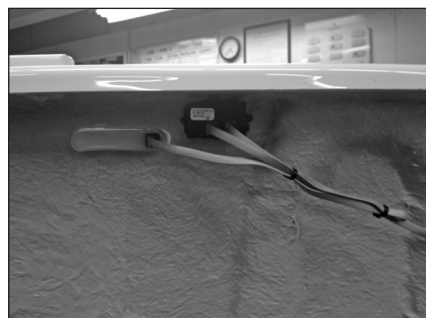

Figure 7B



Modules and keypads are factory installed



Figure 8

INSTALLATION INSTRUCTIONS

DUAL SIDED REMOTE CONTROL INSTALLATION (CONT.)

Remote Control Installation

The following components are necessary

- 1 remote control
- 2 magnets
- 1 receiver module
- 1 cable

1. Determine the appropriate location for the remote control in the bathtub.
2. Determine backside location of magnets
 - A. Hold the remote control in the chosen location.
 - B. From the exterior of the bathtub position the supplied magnets, the attraction force will guide you to the proper area and they will hold in place.
 - C. Mark the position of the magnets with a marker or pencil.

CAUTION: Magnets always have a positive and negative side and will only be attracted to one side. Consider this to avoid applying the silicone to the wrong side.

3. Install magnets on back side
 - A. Apply a dab of silicone to the magnets, place and maintain in the premarked position.
 - B. Let dry in this position.

WARNING: The magnets are extremely powerful despite their small size. Use caution while installing and handling to avoid injuries caused by a sudden movement of the magnets clinging together and possibly pinching fingers, skin or other. Persons with physical conditions that could be affected by magnetic fields should avoid using it and/or consult with their physician.

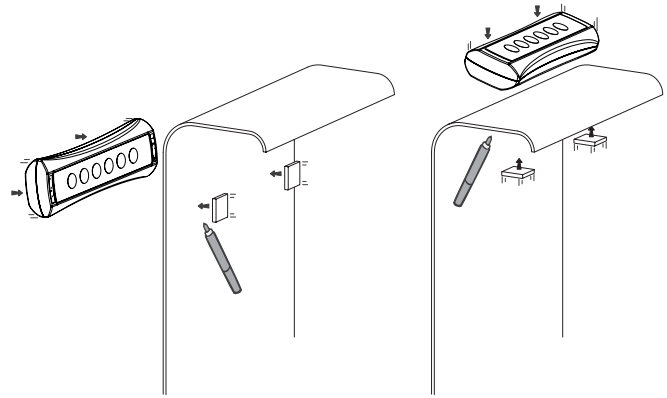

Figure 9A

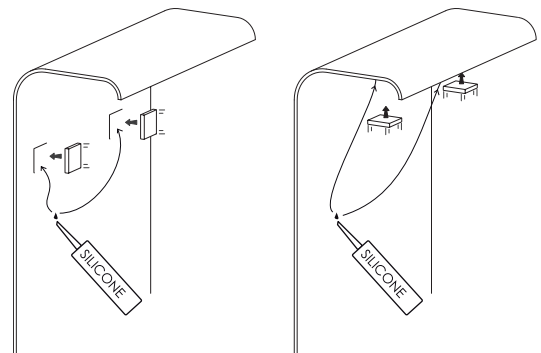

Figure 9B

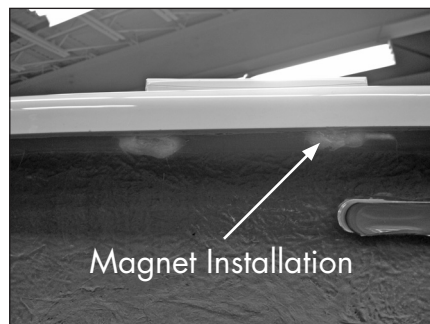

Figure 10



Figure 11

TUB CARE

MAINTENANCE

Before tub is used, the air-whirlpool system should be cleaned and disinfected. Remove all debris and clean tub before putting whirlpool into service. **DO NOT USE ABRASIVE CLEANERS ON THE ACRYLIC FINISH.** Use a non-abrasive detergent and rinse well after cleaning.

- Fill the tub with HOT water to a level 2" above the highest jet.
- Add 4 – 6 tablespoons of low-sudsing automatic dishwashing detergent and no more than 24 – 48 ounces of household bleach to the water.
- Operate whirlpool for 10 minutes. Drain. Note: To effectively clean both the whirlpool and air bath system, you must operate them both.
- Refill with cold water and operate whirlpool for 5 minutes. Drain.

Whirlpool System Cleaning

To remove accumulations of bath residue from the whirlpool system, we recommend that you purge it at least twice a month, or more depending on usage. To do this, follow this simple procedure: Fill the bath with hot water (not exceeding 140° F). Add to the hot water, 6 tablespoons of low foaming detergent such as liquid Cascade or Calgonite and 48 oz. of liquid household bleach, such as Clorox. Run the bath for 5 to 10 minutes. Drain the bath completely and refill with cold water only. Run the whirlpool for 5 to 10 minutes, then drain the bath completely. Depending on the usage and/or the content of the local water supply, more frequent purging may be necessary.

NOTE: DO NOT USE OIL OR OIL BASED BATH ADDITIVES.

If you want to use any kind of bath additive, use only a small amount of low-foaming powder or crystal substance; the whirlpool action intensifies the foaming properties of soaps.

The use of certain bubble baths and bath additives may increase the level of accumulations of bath residue in the whirlpool system. If excess accumulations persist, you should discontinue use of these products.

If you have followed the monthly purging instructions and still have an excess accumulation of bath residue and desire an alternative cleaning mechanism, we recommend **SUPER SYSTEMS CLEAN PLUS** (Aquatic part #ST1010) manufactured by Stearns Packaging Corporation to rectify this condition. This may be obtained by calling Aquatic, at (800) 555-5324. It is recommended that you follow the instructions provided by the manufacturer with the product. Repeated use may be necessary. **SUPER SYSTEMS CLEAN PLUS** does not replace the necessity to purge your whirlpool system at least twice a month with a low foaming detergent and bleach.

Surface Cleaning

Use common household, non-abrasive cleaners for most cleaning jobs. Rinse well and dry with a clean cloth. Never use abrasive cleaners. Do not allow your Lucite® acrylic surface to come into contact with products such as acetone (nail polish remover), nail polish, dry cleaning solution, lacquer thinners, gasoline, pine oil, etc. Remove dust with a soft, dry cloth. Clean grease, oil, paint, and ink stains with isopropyl (rubbing) alcohol.

Jet Cleaning

Most Millennium jets (excluding the 2 Fan Jets) are removable, and can simply be put into the dishwasher for easy cleaning. See **Jet Operation** instructions for removal, starting on page 19. (**NOTE:** Use top rack of dishwasher and remove before the drying cycle starts.) The Fan Jets can be cleaned with a bottle brush and warm, soapy water.

TUB CARE

Surface Scratch Removal

Minor scratches may be removed by polishing your tub with a non-abrasive car polish, followed by buffing. Deeper scratches can be removed by:

- Sanding with wet 400 grit sandpaper.
- Sanding with wet 600 grit sandpaper.
- Sanding with wet micro-grit sandpaper.
- Buff out using car polish.

REPAIR

The service of your air-whirlpool bath should be performed only by a qualified service technician. Remember when contacting your dealer always have your serial number, proof of purchase and model number available. This will ensure a quick response on warranty items.

The model and serial numbers are located above the pump on the backside of the air-whirlpool.

note: all warranty repairs must be authorized by aquatic before work is started. for service, always contact your dealer.

CAUTION: Care should be taken to prevent inappropriate chemicals coming in contact with the Lucite® acrylic surface. Please read and observe all instructions and/or warnings on containers containing substances you contemplate applying to your air-whirlpool. Any failure to comply may void your warranty.

WATER QUALITY

CHEMICAL & WATER QUALITY

Owners of fill and drain air bathtubs need to know basic information concerning water quality, how it affects the performance and enjoyment of the operation of their tubs, and steps that can be taken by the owner to correct related problems. Important issues are the microbiological and chemical quality of the water.

1. Microbiological Quality

Microbes are present in water supplied by individual wells or water systems and even in the air around us. These microbes are usually in amounts below what is noticeable. Microbes from the water or air or from a bather's body may settle on wet surfaces such as a bathtub surface or piping system where they can grow in numbers. With regards to air tubs, brown/black fungi/mold or pigmented (colored) bacteria can be noted.

Fungi/Mold - Fungi and mold are always present. Usually the levels are such that we don't notice them. When moisture and temperature are sufficient, the organisms will grow to levels that we may smell and/or see. The best examples of such growth is the very common black growth on the bottom of shower curtains. The best solution to keep these surfaces free from the growth is frequent cleaning.

Pigmented Bacteria - A pinkish substance may appear on bathroom fixtures that is very persistent, appearing in the shower, sink and along the water line of toilet bowls. The residue is less likely a problem associated with water quality than with naturally occurring airborne bacteria. The bacteria may produce a pinkish film, and sometimes a dark gray film, on surfaces that are regularly moist, including toilet bowls, shower heads, sink drains, and tiles. The problem is more common in humid areas of the country. In any particular case, the determination of the exact species of bacteria causing the problem would require lengthy and costly laboratory testing; however, most experts believe the bacteria responsible is *Serratia marcescens*. These bacteria thrive on moisture, dust and phosphates, and are widely distributed in soil, food and also in animals. The best solution to keep these surfaces free from the bacterial film is continual cleaning. A chlorine containing compound is the best cleaner. Avoid abrasives to limit scratching fixtures, which will make them even more susceptible to bacteria.

2. Chemical Quality

The water supplied by individual wells or water systems always contains chemicals, usually in amounts below those which the consumer would notice. Examples of such chemicals, which are of potential concern for the owners of fill and drain air bathtubs, are calcium and magnesium salts, copper, iron, manganese and sulfates. When these chemicals are present in sufficient amounts, they may cause problems in air bathtubs. You should contact your water supply or treatment company and follow their suggestions for treatment.

Calcium and Magnesium Salts - Collectively, the various compounds of calcium and/or magnesium are referred to as salts. Calcium and magnesium salts are often found in ground water supplies and cause "hardness" in water. Hard and soft water are relative terms. Hard water retards the cleaning action of soaps and detergents, causing expense in the form of extra work and cleaning agents. When hard water is heated, it will deposit a hard scale. With regard to air bathtubs, high calcium and/or magnesium levels may result in the formation of white stains and scale formation on the inside of the tubs, especially noticeable with colored tubs. If this occurs, you need to contact the water supplier to determine the calcium and/or magnesium content and/or corrosion potential of the water and follow their suggestions for treatment. If you are on an individual well, you need to contact a water treatment company to test your water and suggest solutions if a problem is present.

Iron - Iron is found in many natural waters especially from wells. Iron in water can also result from the corrosion of piping in the water supply system, such as cast iron mains or galvanized steel service lines, or galvanized piping in the home water system. High iron levels may result in the formation of brown stains in the vicinity of the faucet outlets of various fixtures in the home. With air bathtubs, the staining may be particularly pronounced because the aeration action can oxidize iron to a form that settles out on the inside of the tubs, especially noticeable with white tubs. If high iron in the water is present, you can also notice rust colored deposits inside your toilet tank or dishwasher. If this

WATER QUALITY

occurs, you need to contact the water supplier to determine the iron content and/or corrosion potential of the water and follow their suggestions for treatment. If you are on an individual well you need to contact the water treatment company to test your water and suggest solutions if a problem is present.

Manganese - Manganese is found in many natural waters especially from wells. High manganese levels may result in the formation of small black particles that can stain laundry, especially noticeable with whites such as sheets or towels. With air bathtubs, the formation of small black particles may be particularly pronounced because the aeration action in the tub can oxidize manganese to an insoluble form that is especially noticeable with white tubs. If high manganese in the water is present, you may also notice black stains on white laundry. If this occurs, you need to contact the water supplier to determine the manganese content of the water and follow their suggestions for treatment. If you are on an individual well, you need to contact a water treatment company to test your water and suggest solutions if a problem is present.

3. Treatment

If you have contacted your water supplier and followed their instructions and you are still having problems, you need to increase the frequency of applications of low-foaming detergent/bleach starting from monthly purging down to using it every other day as required to eliminate your particular problem. The use of certain bath oils, bubble bath soaps and bath additives may increase the level of accumulations of bath residue in the air system. More frequent cleaning may be necessary if these products are used in the air tub. If excess accumulations persist, you should discontinue the use of these products. If you have followed the monthly purging instructions and still have an excess accumulation of bath residue and desire an alternative cleaning mechanism, we recommend SUPER SYSTEMS CLEAN PLUS (Aquatic part # ST1010) manufactured by Stearns Packaging Corporation to rectify this condition. This may be obtained by contacting Aquatic at (800) 945-2726. It is recommended that you follow the instructions provided by the manufacturer with the product. Repeated use may be necessary. SUPER SYSTEMS CLEAN PLUS does not replace the necessity to purge your air system at least once a month with a low foaming detergent and bleach.

TROUBLESHOOTING GUIDE

WARNING: Always turn off power at the main electrical service panel when servicing your whirlpool.

SYMPTOMS	POSSIBLE PROBLEMS	SUGGESTED SOLUTIONS
Motor does not start	<ol style="list-style-type: none"> 1) GFCI or circuit breaker in OFF position. 2) Fuses blown or thermal overload open. 3) Locked motor shaft. 4) Motor windings burned out. 5) Defective starting switch inside single-phase motor. 6) Disconnected or defective wiring. 7) Low voltage. 	<ol style="list-style-type: none"> 1) Reset GFCI. 2) Contact your electrician. 3) Contact Aquatic 4) Contact Aquatic 5) Contact Aquatic 6) Check and reconnect if needed. 7) Contact your electrician.
Motor does not reach full speed	<ol style="list-style-type: none"> 1) Low voltage. 2) Motor windings connected for wrong voltage. 3) Wiring too small. 	<ol style="list-style-type: none"> 1) Contact your electrician. 2) Contact Aquatic. 3) Contact your electrician.
Low pump pressure	<ol style="list-style-type: none"> 1) Pump running at reduced speed. 	<ol style="list-style-type: none"> 1) See above.
Motor overheats (protector trips)	<ol style="list-style-type: none"> 1) Low voltage. 2) Motor windings connected for wrong voltage. 3) Inadequate ventilation. 4) Wiring too small. 	<ol style="list-style-type: none"> 1) Contact your electrician. 2) Contact Aquatic. 3) Refer to installer/dealer. 4) Contact your electrician.
Chromatherapy doesn't function	<ol style="list-style-type: none"> 1) Not plugged in. 2) Bulb burned out. 3) Disconnected or defective wiring. 	<ol style="list-style-type: none"> 1) Plug in. 2) Replace bulb. 3) Check and reconnect if needed.
Pump delivers no water	<ol style="list-style-type: none"> 1) Jets are closed. 2) Leakage of air into suction system. 3) Impeller clogged. 	<ol style="list-style-type: none"> 1) Open jets. 2) Check suction screen for clogs. 3) Clean and unplug.
Low pump capacity	<ol style="list-style-type: none"> 1) Suction or discharge line partly plugged. 2) Pump running at reduced speed. 3) Impeller clogged. 	<ol style="list-style-type: none"> 1) Clean and unplug. 2) See "Motor does not reach full speed." 3) Clean and unplug.
Noisy pump and motor	<ol style="list-style-type: none"> 1) Worn motor bearings. 2) Pumps touching a stationary object. 3) Suction line partly plugged. 4) Pump not supported properly. 	<ol style="list-style-type: none"> 1) Contact Aquatic 2) Refer to installer/dealer. 3) Clean and unplug. 4) Contact Aquatic
Leakage of water at shaft	<ol style="list-style-type: none"> 1) Replace pump. 	<ol style="list-style-type: none"> 1) Contact Aquatic
Leaking unions	<ol style="list-style-type: none"> 1) O-ring missing or damaged. 2) Plumbing in a bind. 3) Loose unions. 	<ol style="list-style-type: none"> 1) Contact Aquatic 2) Contact Aquatic 3) Tighten unions.
Vibration noise	<ol style="list-style-type: none"> 1) Tub or tub plumbing is touching tile/wall. 2) Pump is touching framing. 	<ol style="list-style-type: none"> 1) Refer to installer/dealer. 2) Refer to installer/dealer.
Air Bath system does not operate	<ol style="list-style-type: none"> 1) No power to air blower. 2) Blower Control Box is not plugged in. 3) Control Panel connector to controller box is disconnected. 4) Blower Motor is disconnected from control box. 	<ol style="list-style-type: none"> 1) Reset circuit breakers and GFCI if tripped. 2) Make sure plug is fully inserted into the outlet. 3) Check and reconnect if needed. 4) Plug Blower into control box.
Blower turns off by itself or before time elapses	<ol style="list-style-type: none"> 1) Blower motor overheated and thermal protection device deactivated motor (possibly low voltage). 2) GFCI tripped. 	<ol style="list-style-type: none"> 1) Check that blower has sufficient ventilation, and that the intake to the blower is not blocked, clear and allow motor to cool down. (Check service & wire size.) 2) Refer to installer/dealer.
Circuit breaker trips repeatedly	<ol style="list-style-type: none"> 1) Defective breaker. 2) Short circuit between bath and breaker box. 3) Other items are connected to the same circuit. 	<ol style="list-style-type: none"> 1) Change out breaker. 2) Refer to installer/dealer. 3) Refer to installer/dealer.
Blower does not manually shut off	<ol style="list-style-type: none"> 1) Defective control panel. 2) Defective control box. 	<ol style="list-style-type: none"> 1) Refer to installer/dealer. Replace control panel. 2) Refer to installer/dealer. Replace control box.
Air blower does not function properly while in the pulse or wave modes	<ol style="list-style-type: none"> 1) Speed of air setting is set too low. 	<ol style="list-style-type: none"> 1) Change the air speed setting to a mid-range setting before switching to wave or pulse modes.

REPLACEMENT PARTS LIST

ILLUSTRATION #	PART NUMBER	DESCRIPTION
1A.	8451CONTROL	CONTROL BOX;CHROMATHERAPY;MILL
1B.	8020LIGHTS	CHROMATHERAPY;20LEDS BULB;RND CLR
1C.	(PACKAGED WITH 1B)	LENS REMOVAL TOOL
1D.		20LEDS CHROMATHERAPY BULB
2A.	8186ASSYxx	FULL SIZE DIRECTIONAL JET
2B.	8186VJTB	VJET BODY
	8186BDY	90 DEGREE JET BODY
	8186WFTG	WALL FITTING
3A.	1120xx	1.50GPM SUCTION COVER
3B.	1122NUT	1.50GPM SUCTION NUT
3C.	1124RING	1.50GPM SUCTION COMP RING
3D.	1121ELBOW	1.50GPM SUCTION ELBOW
	1119SLIP	SUCTION SAFETY VALVE
4A.	8180ROTxx	ROTATIONAL SWIRL JET
4B.	8180JTB	JET BODY
4C.	8180NUT	JET NUT
5A.	8180DIRxx	DIRECTIONAL JET
5B.	8180JTB	JET BODY
5C.	8180NUT	JET NUT
6A.	8182DIRxx	
6B.	8182JTB	
6C.	8182NUT	
7A.	8460300WH	FAN JET ASSY-WHITE
	8460300BI	FAN JET ASSY-BI
	8460300BK	FAN JET ASSY-BLACK
	8460300BO	FAN JET ASSY-BO
	8460300ST	FAN JET ASSY-SILVER
	8102ESCBN	FAN JET ASSY-BRUSHED NICKEL
	8102ESCBR	FAN JET ASSY-POLISHED BRASS
	8102ESCCR	FAN JET ASSY-CHROME
7B.	-	OSCILLATING FIN
7C.	-	FAN JET BODY
7D.	-	FAN JET TEE
8A.	9250MAGNET	MAGNET PILLOW MAGNET;ROUND;3/4"X1/8"
8B.	9250PILLWH	MAGNETIC PILLOW; WHITE
8C.	9250PILLBK	MAGNETIC PILLOW;BLACK
9A.	8166KEYPAD	KEYPAD;BDL;LUXEAIR/LIGHT;RECTANGLE
	8168KEYPAD	KEYPAD;BDL;LUXEAIR/LIGHT;OVAL
10A.	8169KEYPAD	KEYPAD;BDL;INFINITY;RECTANGLE
	8170KEYPAD	KEYPAD;BDL;INFINITY;OVAL

REPLACEMENT PARTS LIST

ILLUSTRATION #	PART NUMBER	DESCRIPTION
11A.	8511FTG	3/4" TEE
11B.	8514FTG	3.4" ST 90 EL
12A.	8504FTG	3/4" WYE 22.5 DEG
13A.	1092	3/8" PVC AIR TUBING
13B.	8038TEE	3/8" BARB TEE; AIR
14A.	8012CVALVE	14MM ILLUSION CHECK VALVE
14B.	- 14MM	ILLUSION JET STOPPER
14C.	- 14MM	ILLUSION JET BODY
14D.	- 14MM	ILLUSION WASHER
14E.	8012TEE	ILLUSION TEE
14F.	8012ELBOW	ILLUSION ELBOW
15A.	1093	3FT INTAKE HOSE W/ CLAMPS
15B.	1091	AIR MANIFOLD;4-PORT W/CHK VALVE
15C.	1104BLOWER	BLOWER;750W;HEATER;120V;W/NEMA
16A.	8095HEATER	1.5 KW MAINTENENCE HEATER
16B.	-	2PC. HEATER SPLIT NUT
16C.	8515FTG	2" X 1.5" ADAPTER/ PUMP UNION
16D.	8108MOTOR	1.75HP /120V PUMP
16E.	-	GASKET / O-RING
16F.	-	1.5" X 1" TAILPIECE
17A.	8454CONTROL	CONDO SPA CONTROL BOX
18A.	8452CONTROL	MILLENNIUM EVO2 CONTROL BOX
18B.	-	AIR SEQUENCER COMMUNICATION CABLE
19A.	8108MOTOR	1.75HP /120V PUMP
19B.	8515FTG	2" X 1.5" ADAPTER/ PUMP UNION
19C.	8150UNION	1.5" PUMP UNION
20A.	1093	3FT INTAKE HOSE W/ CLAMPS
20B.	8450BLW	450W BLOWER
20C.	8504SEQ	4 PORT AIR SEQUENCER MODULE KIT
21A.	8453 REMOTE	REMOTE MILLENNIUM REMOTE CONTROL
21B.		REMOTE RECIEVER MODULE CABLE
21C.	(PACKAGED WITH 21A)	REMOTE RECIEVER MODULE
21D.		REMOTE CONTROL MAGNETS

REPLACEMENT PARTS MAP

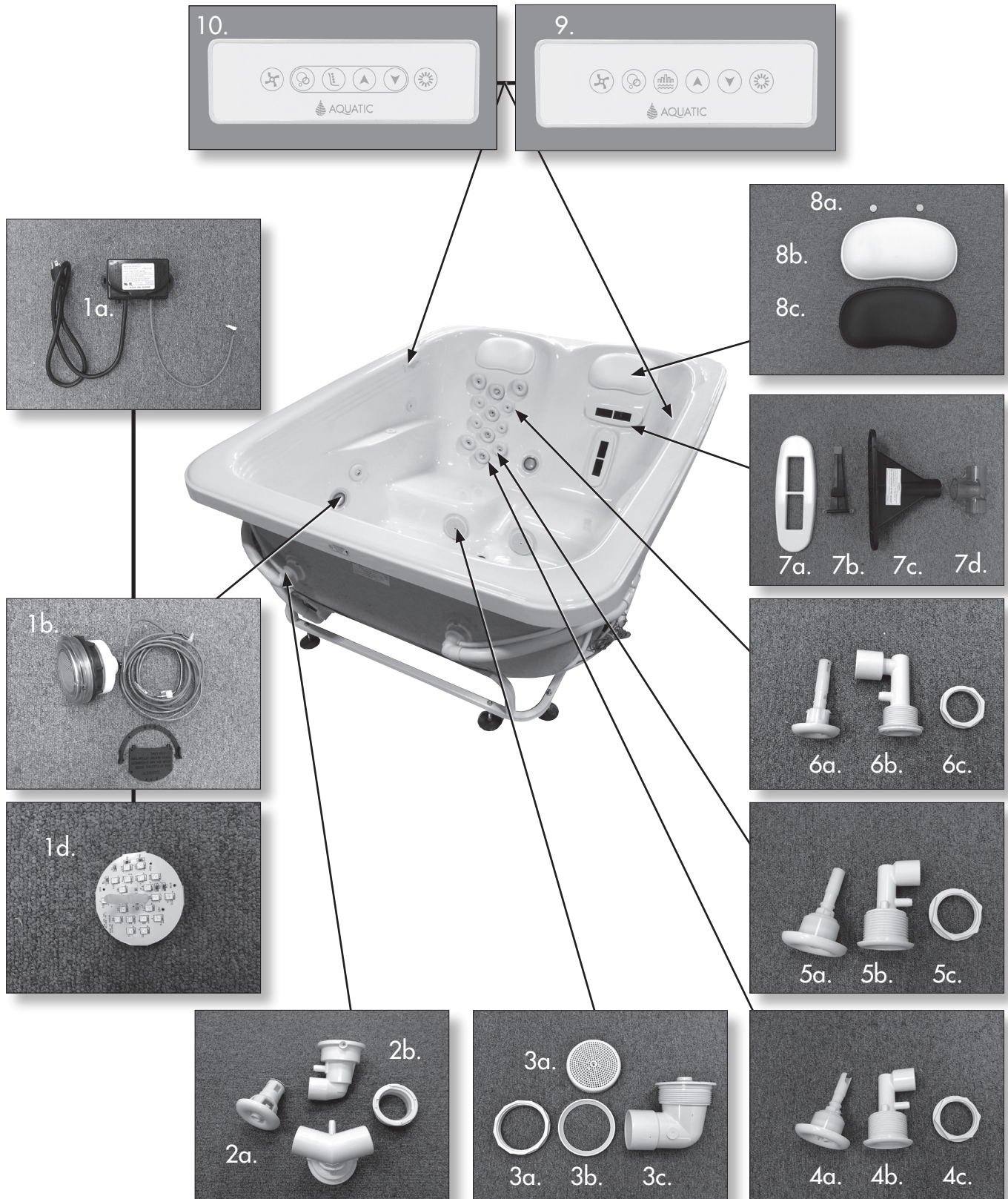

REPLACEMENT PARTS MAP

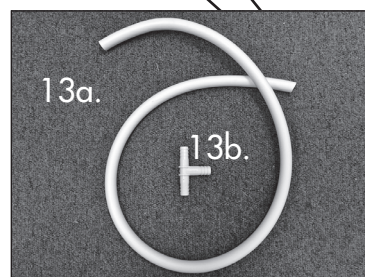
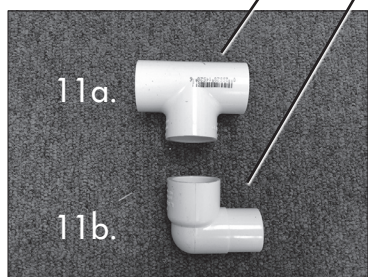
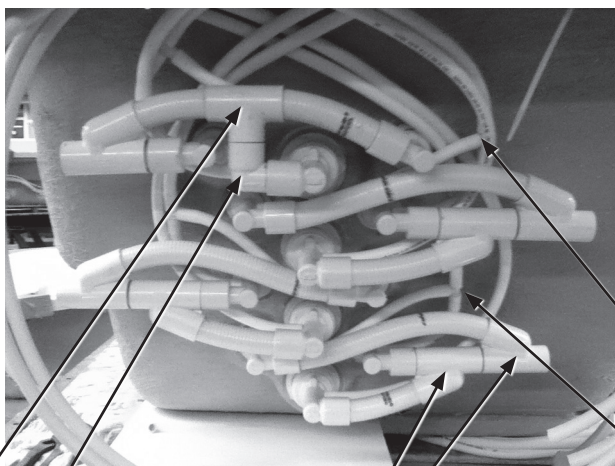

REPLACEMENT PARTS MAP

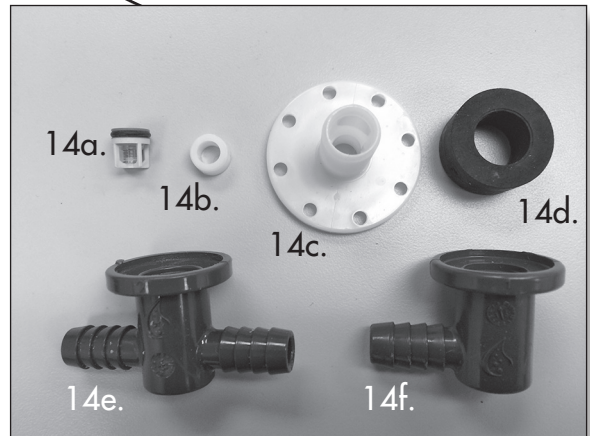
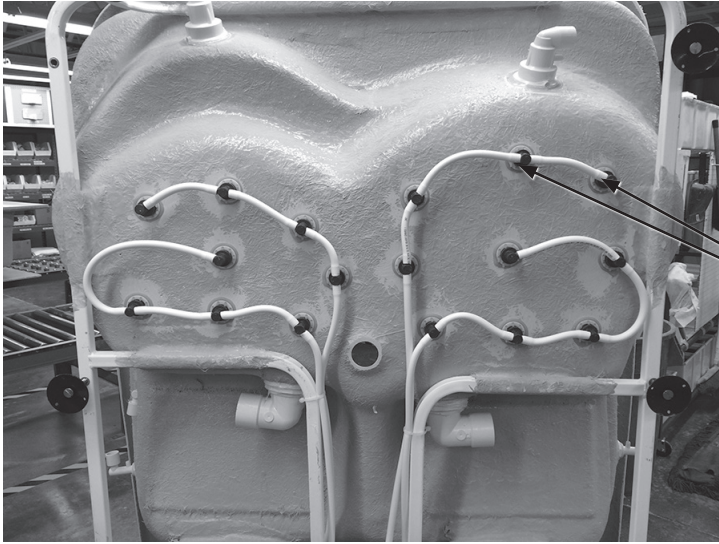

REPLACEMENT PARTS MAP

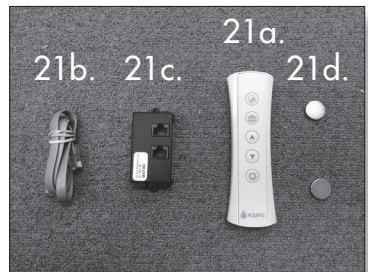
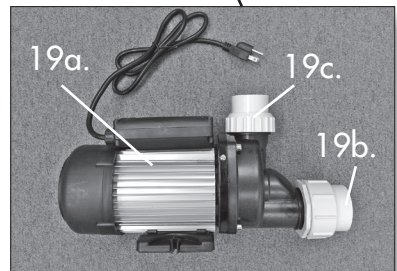
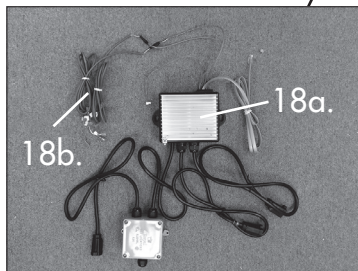
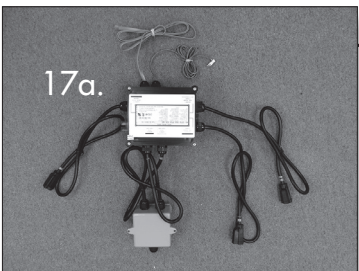
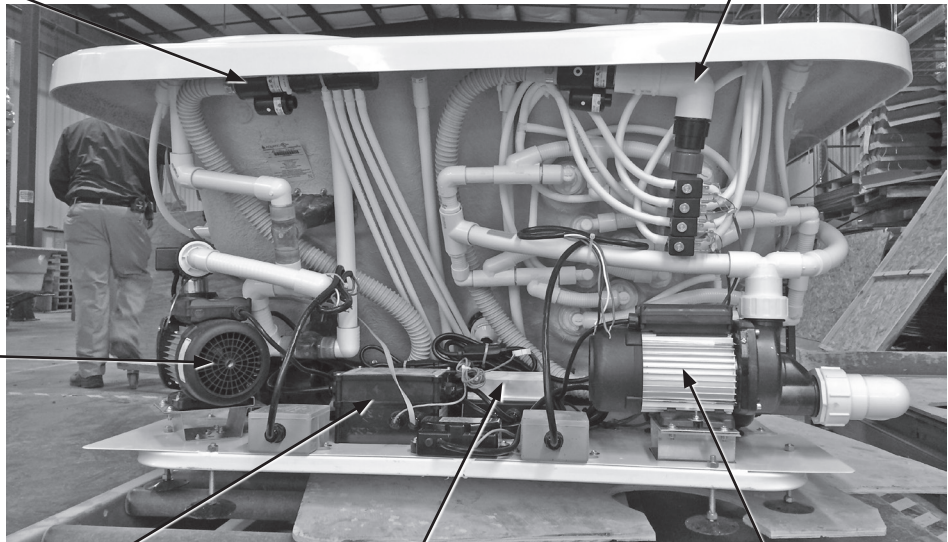
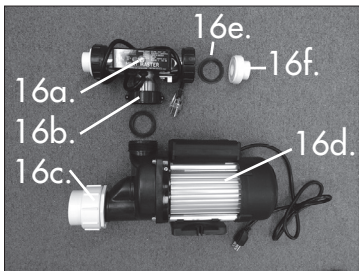
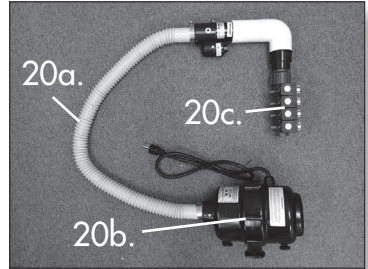
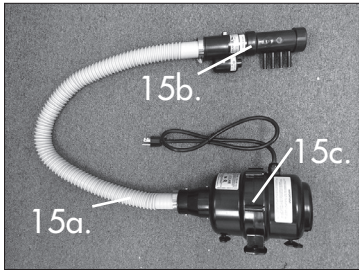



AQUATIC

Where Inspiration Takes Shape

AQUATIC

Fax-On-Demand System: Toll Free (877) 618-7024
8101 E. Kaiser Blvd., Suite 200 • Anaheim, CA 92808
(800) 945-2726 • Fax (866) 544-5353 • www.aquaticbath.com

8MANMIL | F.O.D. #9000 | Rev. 3/14