

Stationary Air Compressors

Compresseur d'Air Stationnaire

Compresores de Aire Estacionarios

Replacement Parts List
 Liste de Pièces de Rechange
 Lista de Repuestos

Model HS418000AJ, HS516000AJ, HS518000AJ & HS518100AJ
 Modèle HS418000AJ, HS516000AJ, HS518000AJ et HS518100AJ
 Modelo HS418000AJ, HS516000AJ, HS518000AJ y HS518100AJ

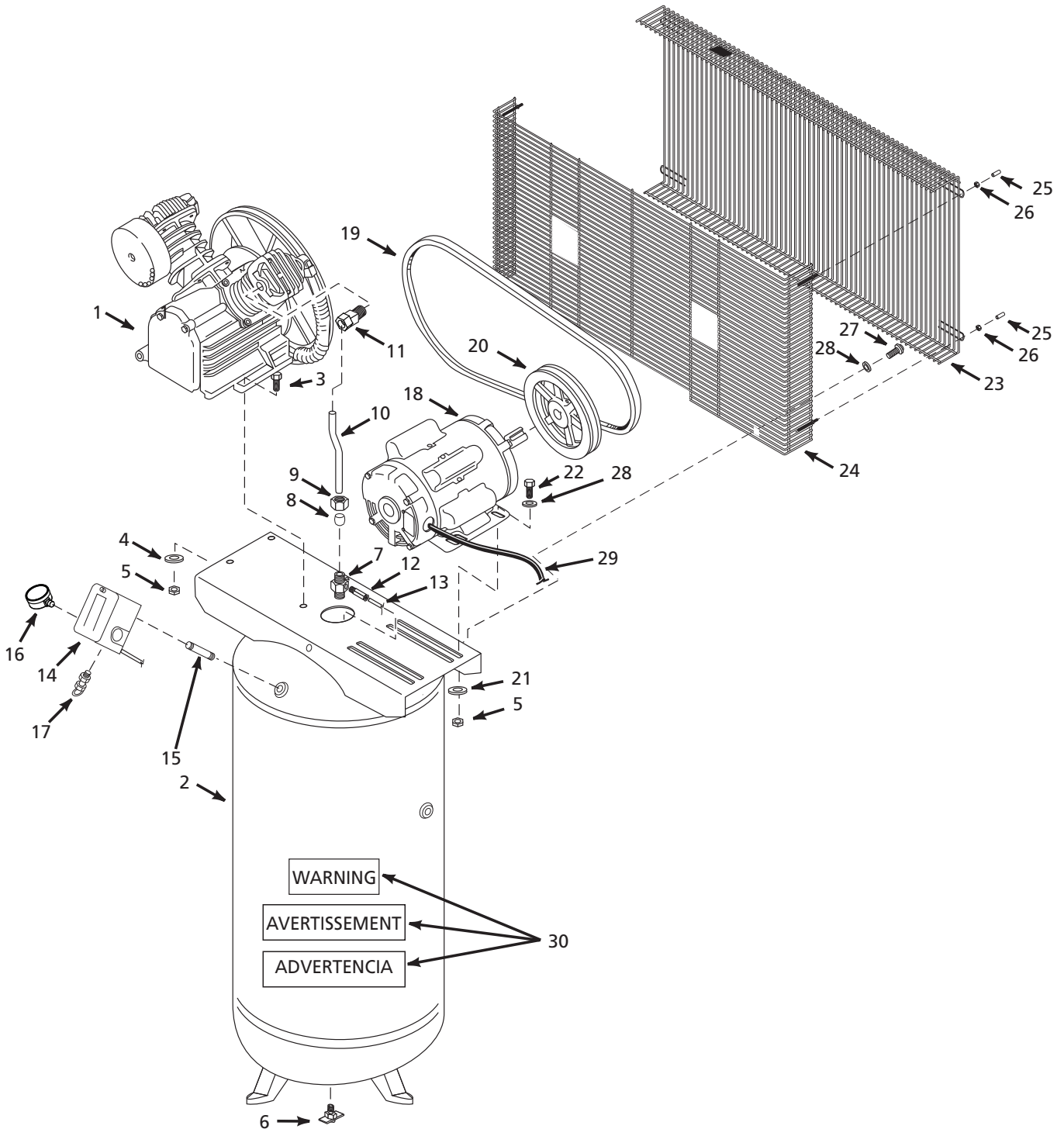

For Replacement Parts or Technical Assistance, Call 1-800-543-6400

Please provide following information:

- Model number
- Serial number (if any)
- Part description and number as shown in parts list

Address any correspondence to:

Campbell Hausfeld
Attn: Customer Service
100 Production Drive
Harrison, OH 45030 U.S.A.



WARNING A beltguard must be used. Use a check valve and an ASME type safety valve with a setting no higher than 200 psi.

Replacement Parts List

Ref. No	Description	HS418000AJ	HS516000AJ	HS518000AJ HS518100AJ	Qty.
1	Air compressor pump	HS050000AV	HS050000AV	HS050000AV	1
2	Air tank	AR210500CG	AR210400CG	AR210500CG	1
3	7/16 inch - 18 x 1-1/2 inch Hex head screw	ST016000AV	ST016000AV	ST016000AV	8
4	Washer	ST070916AV	ST070916AV	ST070916AV	4
5	7/16 inch Hex stop nut	--	--	--	8
6	Drain cock	ST127700AV	D-1403	ST127700AV	1
7	1/2 inch Check valve	CV221502AV	CV221502AV	CV221502AV	1
8	1/2 inch Ferrule	ST032900AV	ST032900AV	ST032900AV	1
9	1/2 inch Compression nut	ST033001AV	ST033001AV	ST033001AV	1
10	Exhaust tube	HS015200AP	HS015200AP	HS015200AP	1
11	1/2 inch T x 1/2 inch P Compression Fitting	ST072019AV	ST072019AV	ST072019AV	1
12	Push Fitting	ST081301AV	ST081301AV	ST081301AV	1
13	Unloader tube	ST117802AV	ST117802AV	ST117802AV	1
14	Pressure switch	CW218000AV	CW218000AV	CW218000AV	1
15	1/4 inch - 18 x 2-3/4 inch Pipe nipple	ST070387AV	ST070387AV	ST070387AV	1
16	1/4 inch NPT, 300 psi Pressure gauge	GA031900AV	GA031900AV	GA031900AV	1
17	Safety valve	V-215200AV	V-215200AV	V-215200AV	1
18	Motor	MC018600SJ	MC019300AV	MC019300AV	1
19	Belt	BT009700AV	BT009700AV	BT009700AV	1
20	Pulley	PU009788AV	PU202612AV	PU202612AV	1
21	M - 10 Washer	ST077303AV	ST077303AV	ST077303AV	4
22	5/16 inch - 18 x 3/4 inch Hex head screw	ST016000AV	ST016000AV	ST016000AV	4
23	Belt guard front	BG021600AV	BG021600AV	BG021600AV	1
24	Belt guard back	BG021700AV	BG021700AV	BG021700AV	1
25	Cap	ST075400AV	ST075400AV	ST075400AV	5
26	10 - 24 Hex flange nut	ST116201AV	ST116201AV	ST116201AV	5
27	5/16 inch Self threading bolt	ST016500AV	ST016500AV	ST016500AV	2
28	5/16 inch Washer	ST011200AV	ST011200AV	ST011200AV	10
29	26 inch Motor cord, 12 AWG	--	EC014800AV	EC014800AV	1
30	Tank warning decals	DK747600AV	DK747600AV	DK747600AV	1

**Pour pièces de rechange ou assistance technique,
appeler 1-800-543-6400**

S'il vous plaît fournir l'information suivante:

- Numéro de Modèle
- Numéro de série (si présent)
- Description et numéro de la pièce

Correspondance:

Campbell Hausfeld
Attn: Customer Service
100 Production Drive
Harrison, OH 45030 U.S.A.



AVERTISSEMENT Un carter de courroie doit être utilisé.

Utilisez un clapet et une soupape de sûreté type ASME avec un réglage qui ne dépasse pas 1379 kPa.

Liste de pièces de rechange

N° de réf.	Description	HS418000AJ	HS516000AJ	HS518000AJ HS518100AJ	Qté.
1	Pompe de compresseur d'air	HS050000AV	HS050000AV	HS050000AV	1
2	Réservoir à air	AR210500CG	AR210400CG	AR210500CG	1
3	Vis à tête hexagonale 7/16 po -18 x 1-1/2 po	ST016000AV	ST016000AV	ST016000AV	8
4	Rondelle	ST070916AV	ST070916AV	ST070916AV	4
5	Écrou d'arrêt hexagonal 7/16 po	--	--	--	8
6	Robinet de vidange	ST127700AV	D-1403	ST127700AV	1
7	Clapet 1/2 po	CV221502AV	CV221502AV	CV221502AV	1
8	Virole 1/2 po	ST032900AV	ST032900AV	ST032900AV	1
9	Écrou de compression 1/2 po	ST033001AV	ST033001AV	ST033001AV	1
10	Tube d'échappement	HS015200AP	HS015200AP	HS015200AP	1
11	Raccord de compression 1/2 po T x 1/2 po P	ST072019AV	ST072019AV	ST072019AV	1
12	Raccords enfichables	ST081301AV	ST081301AV	ST081301AV	1
13	Tuyau de déchargement	ST117802AV	ST117802AV	ST117802AV	1
14	Manostat	CW218000AV	CW218000AV	CW218000AV	1
15	Mamelon de tuyau 1/4 po - 18 x 2-3/4 po	ST070387AV	ST070387AV	ST070387AV	1
16	Manomètre 1/4 po NPT, 2069 kPa	GA031900AV	GA031900AV	GA031900AV	1
17	Soupape de sûreté	V-215200AV	V-215200AV	V-215200AV	1
18	Moteur	MC018600SJ	MC019300AV	MC019300AV	1
19	Courroie	BT009700AV	BT009700AV	BT009700AV	1
20	Poulie	PU009788AV	PU202612AV	PU202612AV	1
21	Rondelle M - 10	ST077303AV	ST077303AV	ST077303AV	4
22	Vis à tête hexagonale 5/16 po -18 x 3/4 po	ST016000AV	ST016000AV	ST016000AV	4
23	Carter de courroie, avant	BG021600AV	BG021600AV	BG021600AV	1
24	Carter de courroie, arrière	BG021700AV	BG021700AV	BG021700AV	1
25	Capuchon	ST075400AV	ST075400AV	ST075400AV	5
26	Écrou à collerette hexagonal 10 - 24	ST116201AV	ST116201AV	ST116201AV	5
27	Boulon auto-filetage 5/16 po	ST016500AV	ST016500AV	ST016500AV	2
28	Rondelle 5/16 po	ST011200AV	ST011200AV	ST011200AV	10
29	Cordon de moteur 12 AWG de 66 cm	--	EC014800AV	EC014800AV	1
30	Décalcomanies d'avertissement pour réservoir	DK747600AV	DK747600AV	DK747600AV	1

Para Ordenar Repuestos o Asistencia Técnica, Sírvase Llamar al Distribuidor Más Cercano a Su Domicilio

Sírvase suministrarlos la siguiente información:

- Número del modelo
- Número de Serie (de haberlo)
- Descripción y número del repuesto según la lista de repuestos

Correspondance:

Campbell Hausfeld
Attn: Customer Service
100 Production Drive
Harrison, OH 45030 U.S.A.



ADVERTENCIA Debe emplearse un protector de faja. Utilice una válvula de retención y una válvula de seguridad tipo ASME con una calibración no mayor de 13,79 bar.

Lista de Partes de Reparación

No. de Ref.	Descripción	HS418000AJ	HS516000AJ	HS518000AJ HS518100AJ	Ctd.
1	Bomba del compresor de aire	HS050000AV	HS050000AV	HS050000AV	1
2	Tanque de aire	AR210500CG	AR210400CG	AR210500CG	1
3	Tornillo de cabeza hex de 11,1 mm (7/16 inch) - 18 x 38,1 mm (1-1/2 inch)	ST016000AV	ST016000AV	ST016000AV	8
4	Arandela	ST070916AV	ST070916AV	ST070916AV	4
5	Tuerca de tope hexagonal de 11,1 mm (7/16 inch)	--	--	--	8
6	Llave de drenaje	ST127700AV	D-1403	ST127700AV	1
7	Válvula de retención 12,7 mm (1/2 inch)	CV221502AV	CV221502AV	CV221502AV	1
8	Férula de 12,7 mm (1/2 inch)	ST032900AV	ST032900AV	ST032900AV	1
9	Tuerca de compresión 12,7 mm (1/2 inch)	ST033001AV	ST033001AV	ST033001AV	1
10	Tubo de escape	HS015200AP	HS015200AP	HS015200AP	1
11	Conexión de compresión 12,7 mm (1/2 inch) en T x 12,7 mm (1/2 inch) en P	ST072019AV	ST072019AV	ST072019AV	1
12	Accesorios de presión	ST081301AV	ST081301AV	ST081301AV	1
13	Tubo de descarga	ST117802AV	ST117802AV	ST117802AV	1
14	Disyuntor neumático	CW218000AV	CW218000AV	CW218000AV	1
15	Niple de tubo 6,4 mm (1/4 inch) -18 x 6,9 cm (2-3/4 inch)	ST070387AV	ST070387AV	ST070387AV	1
16	Indicador de presión 20,7 bar, 6,4 mm (1/4 inch) NPT	GA031900AV	GA031900AV	GA031900AV	1
17	Válvula de seguridad	V-215200AV	V-215200AV	V-215200AV	1
18	Motor	MC018600SJ	MC019300AV	MC019300AV	1
19	Faja	BT009700AV	BT009700AV	BT009700AV	1
20	Polea	PU009788AV	PU202612AV	PU202612AV	1
21	Arandela M - 10	ST077303AV	ST077303AV	ST077303AV	4
22	Tornillo de cabeza hexagonal 7,9 mm (5/16 inch) - 18 x 19,2 mm (3/4 inch)	ST016000AV	ST016000AV	ST016000AV	4
23	Protector frontal de faja	BG021600AV	BG021600AV	BG021600AV	1
24	Protector posterior de faja	BG021700AV	BG021700AV	BG021700AV	1
25	Casquete	ST075400AV	ST075400AV	ST075400AV	5
26	Tuerca de reborde hexagonal 10 - 24	ST116201AV	ST116201AV	ST116201AV	5
27	Perno autorroscante 7,9 mm (5/16 inch)	ST016500AV	ST016500AV	ST016500AV	2
28	Arandela de 7,9 mm (5/16 inch)	ST011200AV	ST011200AV	ST011200AV	10
29	Cordón del motor 66 cm, 12 AWG	--	EC014800AV	EC014800AV	1
30	Etiquetas de advertencia del tanque	DK747600AV	DK747600AV	DK747600AV	1

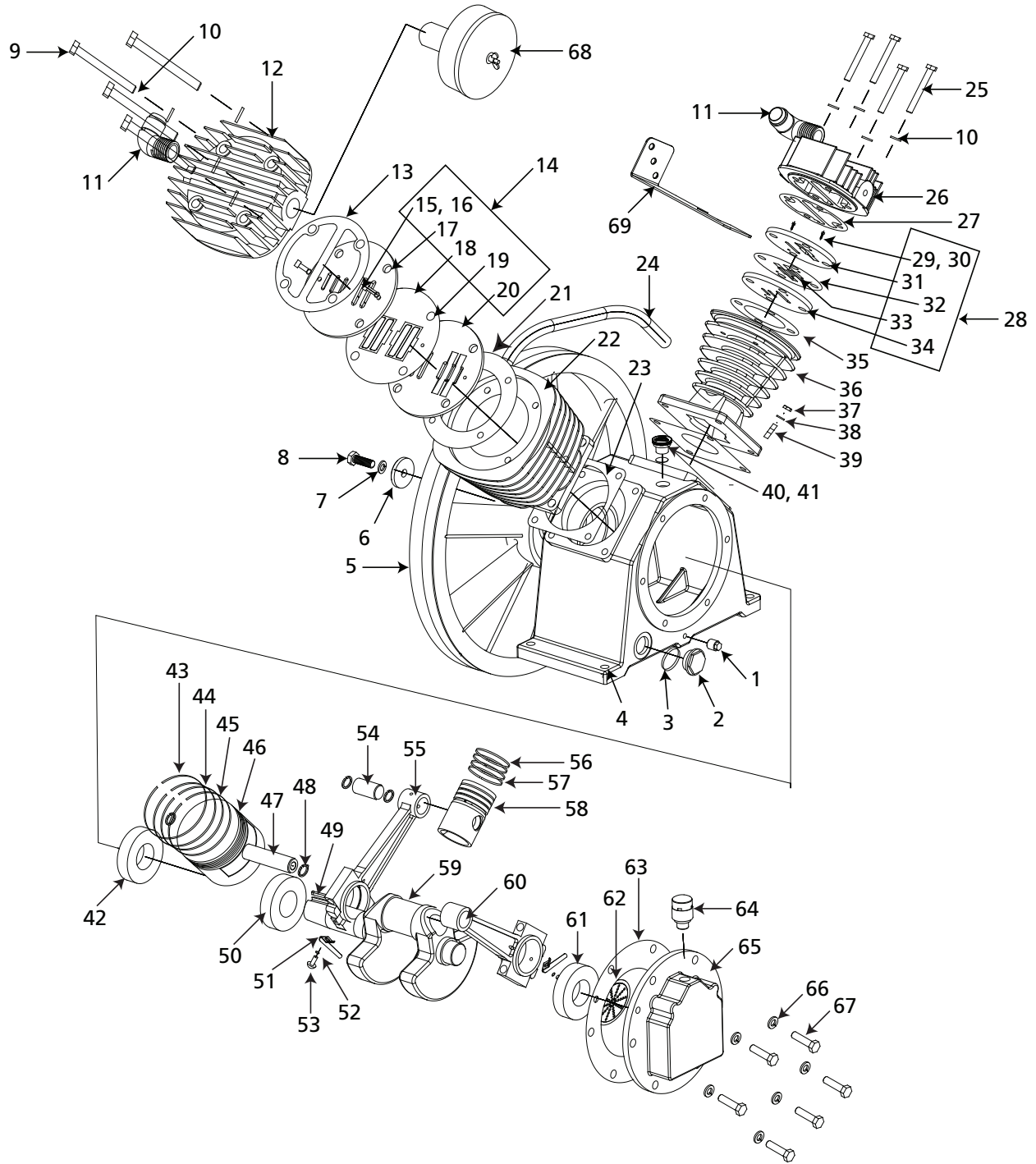

Torque Specifications

Cylinder head bolt	28-36 ft-lbs.
Cylinder to crankcase bolt	28-36 ft-lbs.
Bearing cap bolt	28-36 ft-lbs.
Flywheel bolt	50-57 ft-lbs.

Spécifications de couple

Boulon de culasse	3,9 Nm - 5,0 Nm
Boulon de cylindre à carter	3,9 Nm - 5,0 Nm
Boulon de chapeau de palier	3,9 Nm - 5,0 Nm
Boulon de volant	6,9 Nm - 7,9 Nm

Especificaciones del par de torsión

Perno de culata	3,9 Nm - 5,0 Nm
Perno del cilindro al cárter	3,9 Nm - 5,0 Nm
Perno del retenedor del rodamiento	3,9 Nm - 5,0 Nm
Perno del volante	6,9 Nm - 7,9 Nm

For Replacement Parts or Technical Assistance, Call 1-800-543-6400

Please provide following information:

- Model number
- Serial number (if any)
- Part description and number as shown in parts list

Address any correspondence to:

Campbell Hausfeld
 Attn: Customer Service
 100 Production Drive
 Harrison, OH 45030 U.S.A.



WARNING A beltguard must be used. Use a check valve and an ASME type safety valve with a setting no higher than 200 psi.

Replacement Parts List

Ref. No.	Description	Part No.	Qty.	Ref. No.	Description	Part No.	Qty.
1	1/4 inch NPT Drain plug	◆	1	53	Dipper retaining screw, M4x10	▽†	1
2	Oil level gauge	◆▼	1	54	Wrist pin	○	1
3	Oil level gauge o-ring	◆▼D	1	55	Connecting rod	†	1
4	Crankcase	◆	1	56	Compression ring	∞	3
5	Flywheel	■	1	57	Oil ring	∞	1
6	Flat washer	▲❖	1	58	Piston	○	1
7	Lock washer	▲❖	1	59	Crankshaft	●	1
8	Bolt, M12	▲❖	1	60	Connecting rod (HP)	▽	1
9	Hex Capscrew, M10x80	❖	4	61	Ball bearing	●	1
10	Spring washer, M10	❖	8	62	Rear bearing plate	††	1
11	Intercooler fitting without tapped hole	HS050053AV	2	63	Bearing cap gasket	▷	1
12	Cylinder head (low pressure)	HS050054AV	1	64	Breather assembly	HS050070AV	1
13	Head gasket (LP)	≠▷	1	65	Bearing cap	††	1
14	Valve plate assembly	≠	1	66	Copper washer	❖	1
21	Valve plate - cylinder gasket (LP)	≠▷	1	67	Bolt	❖	1
22	Cylinder (LP)	HS050065AV	1	68	Air filter assembly	DP500056AV	1
23	Cylinder-crankcase packing	▷	2	69	Beltguard bracket	HS050059AV	1
24	Intercooler assembly with flare nuts	HS050066AV	1	NOT SHOWN			
25	Hex bolt, M10x65	❖	4	Air filter element HS050071AV 1			
26	Cylinder head (high pressure)	HS050076AV	1	REPAIR KITS AND ACCESSORIES			
27	Head gasket (HP)	▷✕	1	▲	Flywheel bolt kit	DP500040AV	1
28	Valve plate assembly (HP)	✕	1	■	Flywheel with key	HS050041AV	1
35	Valve plate - cylinder gasket (HP)	▷✕	1	●	Crankshaft assembly with bearings	HS050043AV	1
36	Cylinder (HP)	HS050077AV	1	◆	Crankcase assembly with oil seal, oil level gauge, drain plug, and fill plug	HS050044AV	1
37	Nut	❖	8	▼	Oil level gauge with o-ring	DP400045AV	1
38	Spring washer	❖	8	□	Oil cap with o-ring	DP500046AV	1
39	Stud bolt	❖	8	▽	High pressure connecting rod assembly with dipper	HS050047AV	1
40	Fill plug	◆□	1	†	Low pressure connecting rod assembly with dipper	HS050048AV	1
41	Fill plug o-ring	◆□	1	††	Bearing cap with baffle	HS050050AV	1
42	Oil seal	HS050042AV	1	‡	Piston ring kit (LP)	HS050060AV	1
43	Compression ring	‡	1	‡‡	Piston set (LP)	HS050061AV	1
44	Compression ring	‡	1	○	Piston set (HP)	HS050062AV	1
45	Oil ring	‡	2	∞	Piston ring kit (HP)	HS050063AV	1
46	Piston	‡ ‡	1	≠	Valve plate kit (LP)	HS050064AV	1
47	Wrist pin	‡ ‡	1	▷	Gasket, oil seal and o-ring kit (except valve plate to plate gasket)	HS050068AV	1
48	Retainer clip	‡ ‡ ○	2	❖	Assembly fastener set	HS050069AV	1
49	Key	■	1	✕	Valve plate kit (HP)	HS050075AV	1
50	Ball bearing	●	1				
51	Dipper	▽†	1				
52	Lock washer	▽†	1				

IMPORTANT: Install the air compressor at least 18 inch from the nearest wall or obstruction. Free air flow around the compressor pump is essential for correct operation.

Pour pièces de rechange ou assistance technique, appeler 1-800-543-6400

S'il vous plaît fournir l'information suivante:

- Numéro de Modèle
- Numéro de série (si présent)
- Description et numéro de la pièce

Correspondance:

Campbell Hausfeld
Attn: Customer Service
100 Production Drive
Harrison, OH 45030 U.S.A.



AVERTISSEMENT Un carter de courroie doit être utilisé.

Utilisez un clapet et une soupape de sûreté type ASME avec un réglage qui ne dépasse pas 1379 kPa.

Liste de pièces de rechange

N° de réf.	Description	N° de pièce	Qté.	N° de réf.	Description	N° de pièce	Qté.
1	Robinet de purge - 6,4 mm (1/4 po) NPT	◆	1	53	Vis de retenue de plongeur, M4x10	▽†	1
2	Indicateur de niveau d'huile	◆▼	1	54	Tourillon de crosse	○	1
3	Joint torique d'indicateur de niveau d'huile	◆▼▷	1	55	Bielle de connexion	†	1
4	Carter	◆	1	56	Bague de compression	∞	3
5	Volant	■	1	57	Bague de graissage	∞	1
6	Rondelle plate	▲❖	1	58	Piston	○	1
7	Rondelle-frein	▲❖	1	59	Vilebrequin	●	1
8	Boulon, M12	▲❖	1	60	Bielle de connexion (HP)	▽	1
9	Vis à chapeau hexagonal, M10x80	❖	4	61	Roulement à billes	●	1
10	Rondelle à ressort, M10	❖	8	62	Plaque d'appui arrière	††	1
11	Raccord de refroidisseur interne sans trou taraudé	HS050053AV	2	63	Joint de chapeau de palier	▷	1
12	Tête du cylindre (basse pression)	HS050054AV	1	64	Assemblage de reniflard	HS050070AV	1
13	Joint d'étanchéité de tête (BP)	≠▷	1	65	Chapeau de palier	††	1
14	Montage de plaque de soupape	≠	1	66	Rondelle de cuivre	❖	1
21	Plaque de soupape - joint d'étanchéité de cylindre (BP)	≠▷	1	67	Boulon	❖	1
22	Cylindre (BP)	HS050065AV	1	68	Montage de filtre à air	DP500056AV	1
23	Garnissage carter-cylindre	▷	2	69	Fixation de protecteur de courroie	HS050059AV	1
24	Assemblage de refroidisseur avec écrous évasés	HS050066AV	1	PAS INDIQUÉ			
25	Boulon hexagonal, M10x65	❖	4		Cartouche filtrante	HS050071AV	1
26	Tête du cylindre (haute pression)	HS050076AV	1	NÉCESSAIRES DE PIÈCES DE RECHANGE			
27	Joint d'étanchéité de tête (HP)	▷✕	1	▲	Trousse de boulon de volant	DP500040AV	1
28	Montage de plaque de soupape (HP)	✕	1	■	Volant moteur avec clé	HS050041AV	1
35	Plaque de soupape - joint d'étanchéité de cylindre (HP)	▷✕	1	●	Assemblage de carter avec roulements	HS050043AV	1
36	Cylindre (HP)	HS050077AV	1	◆	Montage de carter avec joint d'étanchéité d'huile, jauge de niveau d'huile, robinet de purge et bouchon de remplissage	HS050044AV	1
37	Écrou	❖	8	▼	Indicateur de niveau d'huile	DP400045AV	1
38	Rondelle à ressort	❖	8	□	Bouchon d'huile avec joint torique	DP500046AV	1
39	Goujon	❖	8	▽	Assemblage de bielle haute pression avec plongeur	HS050047AV	1
40	Bouchon de remplissage	◆□	1	†	Assemblage de bielle basse pression avec plongeur	HS050048AV	1
41	Joint torique de bouchon de remplissage	◆□	1	††	Chapeau de palier avec déflecteur	HS050050AV	1
42	Bague d'étanchéité d'huile	HS050042AV	1	‡	Trousse de bagues de piston (BP)	HS050060AV	1
43	Bague de compression	‡	1	‡‡	Jeu de pistons (BP)	HS050061AV	1
44	Bague de compression	‡	1	○	Jeu de pistons (HP)	HS050062AV	1
45	Bague de graissage	‡	2	∞	Trousse de bagues de piston	HS050063AV	1
46	Piston	‡‡	1	≠	Trousse de plaque porte-soupape (LP)	HS050064AV	1
47	Tourillon de crosse	‡‡	1	▷	Ensemble de joint d'étanchéité, joint d'étanchéité d'huile et joint torique (sauf la plaque de soupape au joint d'étanchéité de plaque)	HS050068AV	1
48	Pince de retenue	‡‡○	2	❖	Ensemble d'attaches d'assemblage	HS050069AV	1
49	Clavette	■	1	✕	Trousse de plaque porte-soupape (HP)	HS050075AV	1
50	Roulement à billes	●	1				
51	Plongeur	▽†	1				
52	Rondelle-frein	▽†	1				

IMPORTANT: Installer le compresseur d'air au moins 45,7 cm d'un mur ou d'une obstruction. La circulation de débit d'air autour de la pompe de compresseur est nécessaire pour le bon fonctionnement.

Para Ordenar Repuestos o Asistencia Técnica, Sírvase Llamar al Distribuidor Más Cercano a Su Domicilio

Sírvase suministrarlos la siguiente información:
 - Número del modelo
 - Número de Serie (de haberlo)
 - Descripción y número del repuesto según la lista de repuestos

Correspondance:
 Campbell Hausfeld
 Attn: Customer Service
 100 Production Drive
 Harrison, OH 45030 U.S.A.



ADVERTENCIA Debe emplearse un protector de faja.
 Utilice una válvula de retención y una válvula de seguridad tipo ASME con una calibración no mayor de 13,79 bar.

Lista de Partes de Reparación

No. de Ref.	Descripción	No. de Parte	Ctd.	No. de Ref.	Descripción	No. de Parte	Ctd.
1	Válvula de drenaje - NPT de 6,4 mm (1/4 inch)	◆	1	53	Tornillo de retención del cucharón, M4x10	▽†	1
2	Indicador del nivel de aceite	◆▼	1	54	Pasador	○	1
3	Anillo en o del indicador del nivel de aceite	◆▼▷	1	55	Varilla de conexión	†	1
4	Caja del cigüeñal	◆	1	56	Anillo de compresión	∞	3
5	Volante	■	1	57	Anillo de aceite	∞	1
6	Arandela plana	▲✱	1	58	Pistón	○	1
7	Arandela de seguridad	▲✱	1	59	Cigüeñal	●	1
8	Perno, M12	▲✱	1	60	Varilla de conexión (AP)	▽	1
9	Tornillo de sombrerete hexagonal, M10x80	✱	4	61	Cojinete	●	1
10	Arandela elástica, M10	✱	8	62	Placa del soporte trasero	††	1
11	Adaptador de refrigerador interno sin orificio roscado	HS050053AV	2	63	Empaque para la tapa edl cojinete	▷	1
12	Cabeça do cilindro (Baja presión)	HS050054AV	1	64	Ensamblaje del respiradero	HS050070AV	1
13	Junta del cabezal (Baja presión)	≠▷	1	65	Tapa de los cojinetes	††	1
14	Ensamblaje de la placa de la válvula	≠	1	66	Arandela de cobre	✱	1
21	Placa de la válvula - junta del cilindro (BP)	≠▷	1	67	Perno	✱	1
22	Cilindro (BP)	HS050065AV	1	68	Ensamblaje del filtro de aire	DP500056AV	1
23	Empaque de cilindro-caja del cigüeñal	▷	2	69	Ménsula del guardafaja	HS050059AV	1
24	Ensamble de interrefrigerador con tuercas acampanadas	HS050066AV	1	NO SE MUESTRA			
25	Perno hexagonal, M10x65	✱	4	Elemento del filtro			HS050071AV
26	Cabeça do cilindro (Alta presión)	HS050076AV	1	JUEGOS DE REPUESTOS Y ACCESORIOS			
27	Junta del cabezal (AP)	▷✱	1	▲	Juego de perno del volante	DP500040AV	1
28	Ensamblaje de la placa de la válvula (AP)	✱	1	■	Volante con llave	HS050041AV	1
35	Placa de la válvula - junta del cilindro (AP)	▷✱	1	●	Ensamblaje de la caja del cigüeñal con cojinetess	HS050043AV	1
36	Cilindro (AP)	HS050077AV	1	◆	Ensamblaje de la caja del cigüeñal con sello de aceite, indicador del nivel de aceite, tapón de drenaje y tapón de llenado	HS050044AV	1
37	Tuerca	✱	8	▼	Indicador del nivel de aceite	DP400045AV	1
38	Arandela de resorte	✱	8	□	Tapón de aceite con anillo en o	DP500046AV	1
39	Perno prisionero	✱	8	▽	Ensamble de la barra conectora de alta presión con cucharón	HS050047AV	1
40	Tapón de llenado	◆□	1	†	Ensamble de la barra conectora de baja presión con cucharón	HS050048AV	1
41	Anillo en O del tapón de llenado	◆□	1	††	Tapa del cojinete con deflector	HS050050AV	1
42	Sello del sistema de lubricación	HS050042AV	1	‡	Juego de anillos del pistón de BP	HS050060AV	1
43	Anillo de compresión	‡	1	‡‡	Juego de pistón (BP)	HS050061AV	1
44	Anillo de compresión	‡	1	○	Juego de pistón (AP)	HS050062AV	1
45	Anillo de aceite	‡	2	∞	Juego de anillos del pistón de AP	HS050063AV	1
46	Pistón	‡‡	1	≠	Juego del plato de la válvula (BP)	HS050064AV	1
47	Pasador	‡‡	1	▷	Juego de junta, sello de aceite y anillo en O (excepto placa de la válvula a junta de la placa)	HS050068AV	1
48	Broche del retén	‡‡○	2	✱	Juego de sujetador de ensamble	HS050069AV	1
49	Chaveta	■	1	✱	Juego del plato de la válvula (AP)	HS050075AV	1
50	Cojinete	●	1				
51	Cucharón	▽†	1				
52	Arandela de seguridad	▽†	1				

IMPORTANTE: Instale el compresor de aire por lo menos a 45,7 cm de la pared u obstrucción más cercana. El libre flujo del aire alrededor de la bomba del compresor es esencial para el funcionamiento correcto.