

WALL CUBE/RECTANGLE

way basics^o

Included



Dowels x 16



Vertical zBoards x 2



Horizontal zBoards x 2

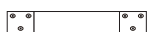

Hook bracket guide (28.5 x 28.5 cm)

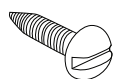

Screws x 6

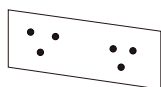

Drilling Template



Glue



Hook bracket guide (50 x 28.5 cm)

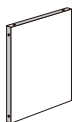

Backboard x 1 (with metal fitting)

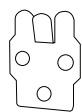

Wall Attachments x 2



WARNING:
CHOKING HAZARD
Small parts NOT for
children under 3 years

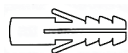

Plastic Anchors x 6

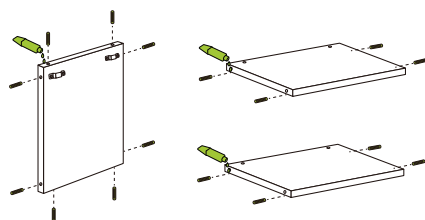

1 Apply glue into the pre-drilled holes and insert dowels into horizontal zBoards and backboard.

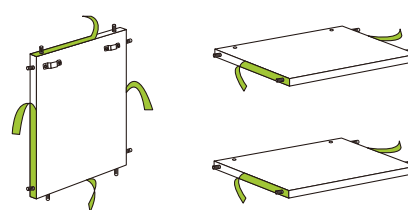

2 Remove protective strips on horizontal zBoards and backboard.

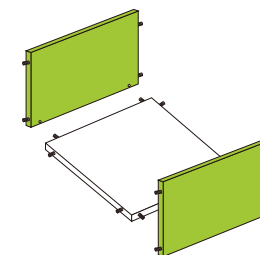

3 Assemble the horizontal zBoards and backboard. Notice that the metal fitting needs to be on the back.

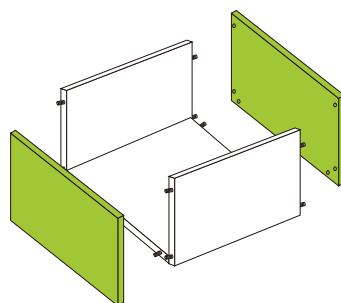

4 Assemble the vertical zBoards.

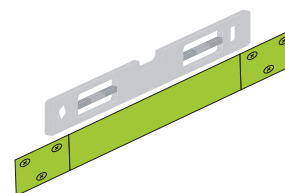

5 Level the guide sticker and stick it on the wall.

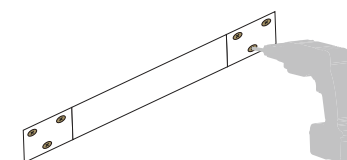

6 Drill 6 holes at center of the ovals.

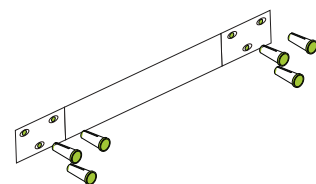

7 Insert anchors into holes.

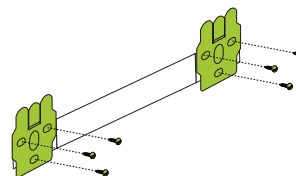

8 Fasten hook brackets to wall anchors with screws.

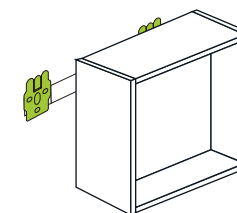

9 Hang the assembled wall cube on the hook brackets.



Watch and Assemble www.waybasics.com/help-wall-cube



Help and Comments www.waybasics.com/contact



Share and Win www.waybasics.com/share