

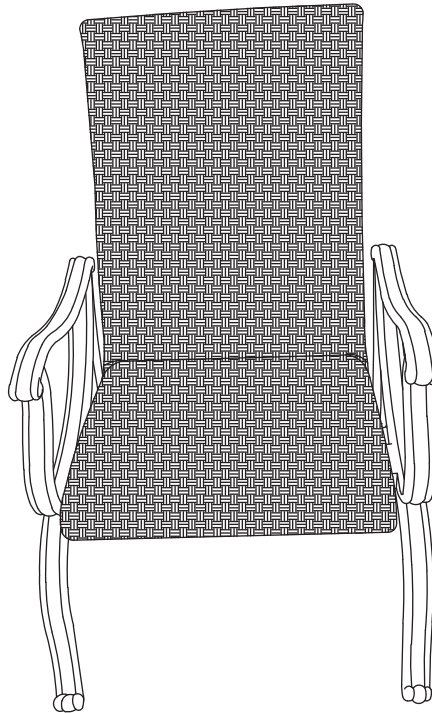

Item #639359
Model #HD14204

USE AND CARE GUIDE

2-PIECE PEMBREY STATIONARY ROCKING CHAIRS



Questions, problems, missing parts? Before returning to the store,
call Hampton Bay Customer Service
8:00 a.m. - 6:00 p.m., EST, Monday-Friday

1-855-HD-HAMPTON

HAMPTONBAY.COM

THANK YOU

We appreciate the trust and confidence you have placed in Hampton Bay through the purchase of these chairs. We strive to continually create quality products designed to enhance your home. Visit us online to see our full line of products available for your home improvement needs. Thank you for choosing Hampton Bay!

Table of Contents

Table of Contents.....	2	Pre-Assembly.....	3
Safety Information.....	2	Planning Assembly.....	3
Warranty.....	2	Hardware Included.....	3
3 Year Frame Limited Warranty, 2 Year Fabric		Package Contents.....	4
and Weave Limited Warranty.....	2	Assembly.....	5
What Is Covered.....	2		
What Is Not Covered.....	2		
Care Instructions.....	2		

Safety Information



DANGER: Please keep children out of the assembly area before assembly.



IMPORTANT: Please check the tightness of the bolts at least every 90 days.



WARNING: Do not put heavy objects on the chair.

Warranty

3 YEAR FRAME / 2 YEAR FABRIC AND WEAVE LIMITED WARRANTY

WHAT IS COVERED

We warrant the frame to be free of manufacturing defects to the original purchaser for three years and the fabric and weave for two years.

WHAT IS NOT COVERED

It remains the customer's responsibility for freight and packaging charges to and from our service center. This warranty does not cover commercial use, hardware, acts of nature, fire, freezing and abusive use. In addition, purchased parts are not covered under this warranty. We reserve the right to make substitutions with similar merchandise, if the model in question is no longer in production.

Care Instructions

Before using, wipe with a clean, dry cloth. Do not use bleach or solvents. Treat the frame with liquid wax for maximum protection against UV light and salty, damp air. When not in use, store furniture in a cool, dry place. If your set includes cushions or mesh fabric, they may be cleaned by hand with a mild solution of soap and water. Rinse cushions thoroughly and allow to drip dry. Do not machine wash or tumble dry, as cushions may shrink. Do not use bleach or solvents on fabrics. When cleaning the tabletop make sure to use a soft, clean cloth that does not bleed color.

You may contact our customer service department with any questions by phone at 1-855-HD-HAMPTON or visit www.hamptonbay.com.

Pre-Assembly

PLANNING ASSEMBLY

It will take one person about 25 minutes to complete the assembly process.

Assemble this product on a blanket or towel or other soft, non-abrasive surface to avoid scratching the finish.

HARDWARE INCLUDED



NOTE: Hardware not shown to actual size.

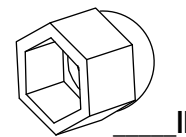
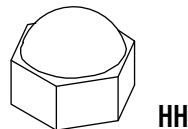
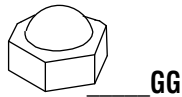
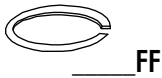
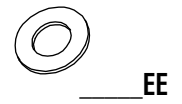
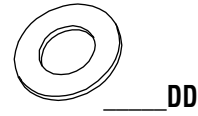
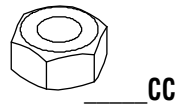
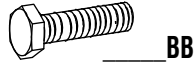
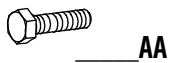

Part	Description	Quantity
AA	Bolt (M6 x 15 mm)	16
BB	Bolt (M8 x 35 mm)	8
CC	Nut (M8)	8
DD	Metal Washer (M8)	8
EE	Metal Washer (M6)	16
FF	Lock Washer	8
GG	Plastic Bolt Cap (M6)	16
HH	Plastic Bolt Cap (M8)	8
II	Plastic Nut Cap (M8)	8
JJ	Steel Plate	8
KK	Hex Wrench (M6)	1
LL	Hex Wrench (M8)	2

Pre-Assembly (continued)

PACKAGE CONTENTS

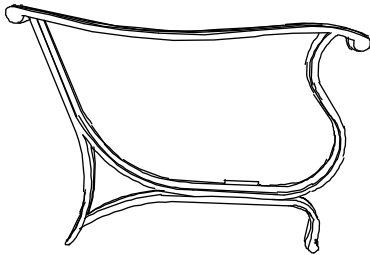

_____ **A**

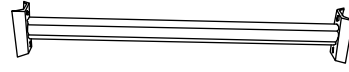

_____ **D**

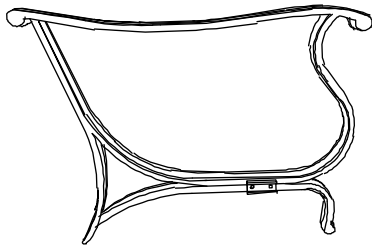

_____ **B**

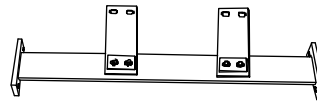

_____ **E**

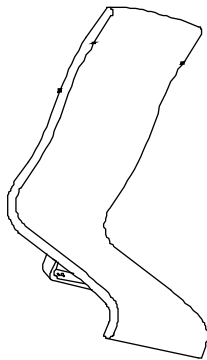

_____ **C**

Part	Description	Quantity
A	Right Arm (When Sitting)	2
B	Left Arm (When Sitting)	2
C	Seat and Back Combination	2
D	Back Cross Bar	2
E	T-Rock	2

Assembly

1 Attaching the T-Rock and back cross bar to the left arm

- Attach the T-Rock (E) to the inside front of the left arm (B) by inserting bolts (AA) with metal washers (EE) through the two pre-drilled holes. Position the T-Rock (E) with steel plate as shown.
- Attach the back cross bar (D) to the inside back of the left arm (B) by inserting bolts (AA) with metal washers (EE) through the two pre-drilled holes.

! **IMPORTANT:** Do not tighten completely until assembly is completed.

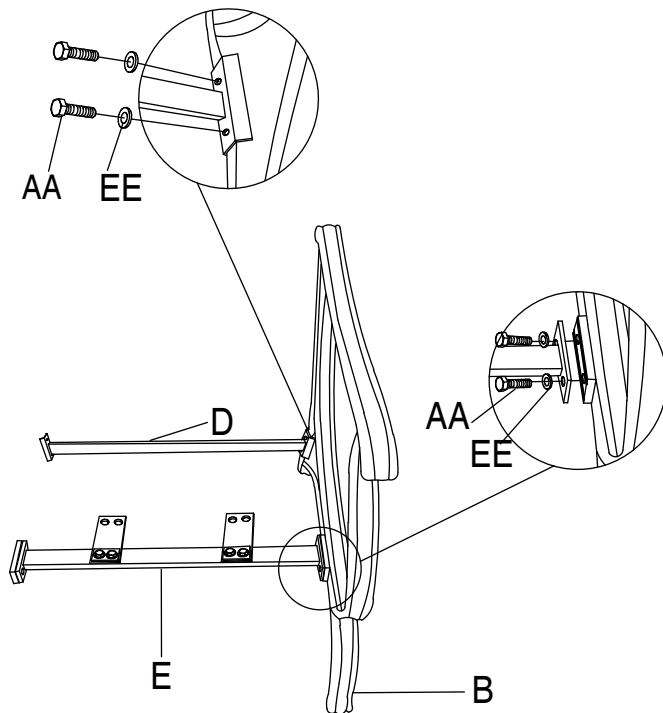

2 Attaching the T-Rock and back cross bar to the right arm

- Repeat step 1 for the right arm (A). Please do NOT tighten completely.

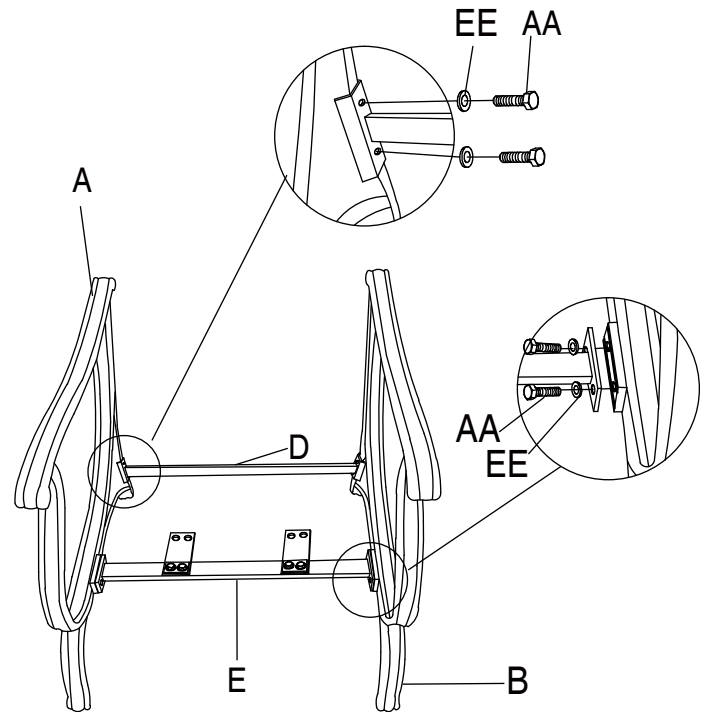

Assembly (continued)

3 Attaching the seat and back combination to the chair base

- With the help of another person, turn over the newly completed chair base (A, B, D, and E) and carefully align with the seat and back combination (C). Attach in order, using bolts (BB), metal washer (DD), small rectangular steel plate (JJ), seat and back combination (C), T-Rock (E), small rectangular steel plate (JJ), lock washer (FF), and nuts (CC).



IMPORTANT: Bolts are inserted from underneath the seat (closest to woven wicker seat) through crossbar into T-rock. Two rectangular steel plates are used for each side in sequence as noted above.

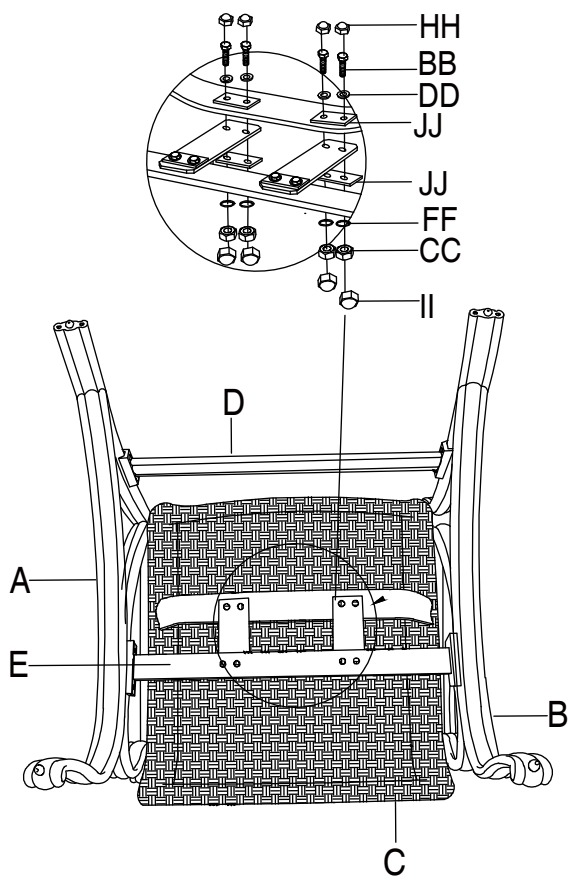

4 Completing the assembly



NOTE: If the chair frame does not align between the arms, unscrew all bolts and re-adjust the chair frame accordingly. Do not tighten completely until assembly is completed.

- Tighten all the bolts and nuts with hex wrenches, and then cover with plastic caps (GG, HH and II).
- Carefully turn over the completed chair frame. Your chair is now ready for use, so relax & enjoy!

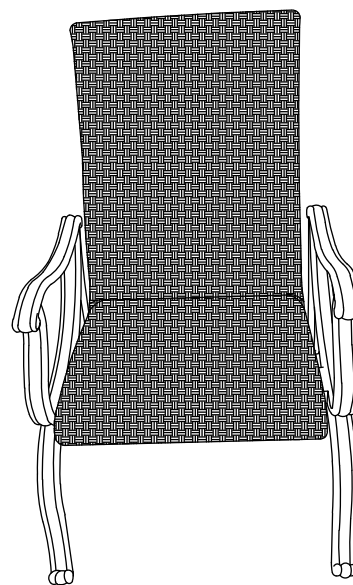



**Questions, problems, missing parts? Before returning to the store,
call Hampton Bay Customer Service
8:00 a.m. - 6:00 p.m., EST, Monday-Friday**

1-855-HD-HAMPTON

HAMPTONBAY.COM

Retain this manual for future use.