





Cable Modem Label

The cable modem label is located on the bottom of your SB6183.

To receive high-speed Internet service, your service provider may request the Media Access Control (MAC) address (see **HFC MAC ID**) and Serial number (see **S/N**) listed on the cable modem label.

LED Status

 POWER	ON - Green: Power is properly connected
 RECEIVE	ON - Green: Downstream channel is connected ON - Blue: High-speed Internet connection with bonded downstream channels
 SEND	ON - Green: Upstream channel is connected ON - Blue: High-speed Internet connection with bonded upstream channels
 ONLINE	ON - Green: Cable modem is connected to the Internet

© 2015 ARRIS Enterprises, Inc. All rights reserved.

No part of this publication may be reproduced or transmitted in any form or by any means without written permission from ARRIS Enterprises, Inc.

ARRIS, SURFboard, and the ARRIS logo are all trademarks or registered trademarks of ARRIS Enterprises, Inc. Other trademarks and trade names may be used in this document to refer to either the entities claiming the marks and the names of their products. ARRIS disclaims proprietary interest in the marks and names of others.

All other product or service names are the property of their respective owners. No part of the contents of this document may be reproduced or transmitted in any form or by any means without the written permission of the publisher.

ARSVD01667-a 10/2015



SURFboard™ SB6183

DOCSIS® 3.0 Cable Modem

Quick Start Guide

In the Box

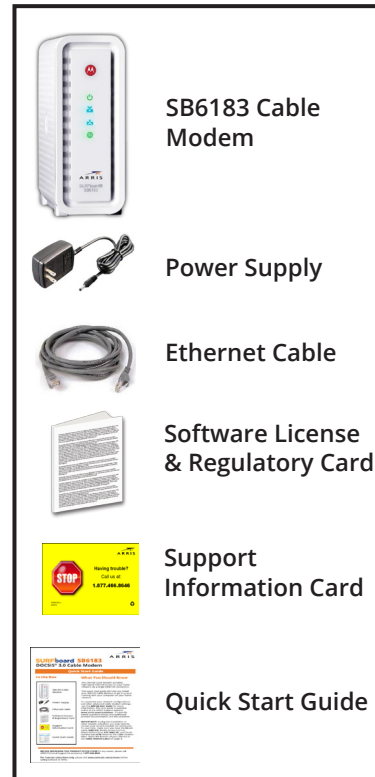

What You Should Know

The SB6183 Cable Modem provides high-speed Internet access on your home network via a single Ethernet connection.

This quick start guide will help you install your SB6183 Cable Modem to get it up and running with your computer on your home network.

To customize your network configurations and other advanced cable modem settings, see the **SB6183 User Guide** for more information. The user guide is available online at the ARRIS Support website: www.arris.com/consumer. Frequently Asked Questions (FAQs) and additional product documentation are also available.

IMPORTANT! During the installation or cable modem activation, you may need to contact your service provider for assistance. To save time, make sure you have the Model name (**SB6183**), Media Access Control (MAC) address (see **HFC MAC ID**), and Serial number (see **S/N**) listed on the cable modem label. Check the bottom of your SB6183 or see **Cable Modem Label** on page 4.

BEFORE RETURNING THIS PRODUCT TO THE STORE for any reason, please call ARRIS Technical Support for assistance: **1-877-466-8646**

For Comcast subscribers only, please visit www.comcast.com/activate before calling Comcast or ARRIS.

Install the Cable Modem

1. Connect the coaxial cable to a cable wall outlet (if not connected) and the **Cable** connector on the rear of your SB6183. Hand-tighten each connector.
2. Connect the Ethernet cable to the **Ethernet** port on your computer and to the **Ethernet** port on the rear of your SB6183.
3. Connect the power cord to the **Power** port on the rear of your SB6183 and then plug it into an electrical wall outlet that is not controlled by a wall switch.

This automatically powers ON your SB6183. Check the front panel LEDs on your SB6183. During the initial startup, the **Power, Receive, Send,** and **Online** LEDs will FLASH. Afterwards, check that all four LEDs are lit SOLID green or blue.

To view and monitor the configuration settings and operational status of your SB6183, please see the ***SURFboard SB6183 User Guide*** for more information at www.arris.com/consumer.

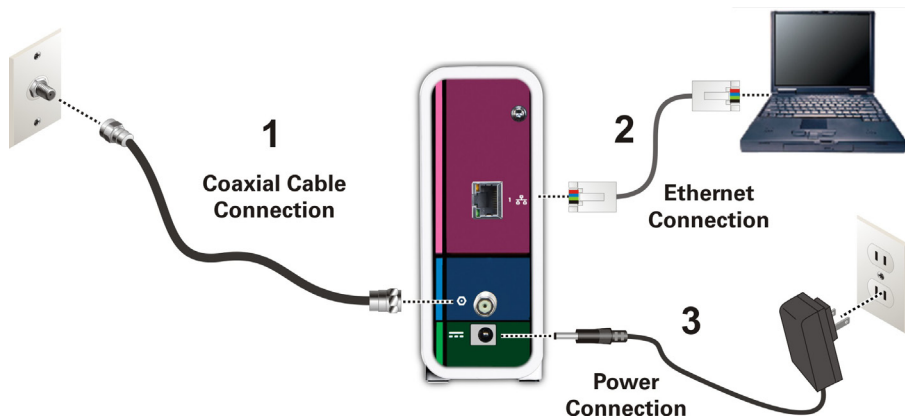

Front Panel LEDs

During normal operation, the **Power, Receive, Send,** and **Online** LEDs on the SB6183 front panel should always be lit SOLID green or blue.

Note: During startup, all four LEDs will FLASH and then light up SOLID in sequence. If the **Power** LED does not light up SOLID, please first check the power connection on your SB6183 before contacting ARRIS Technical Support. If the other LEDs do not light up SOLID green or blue, please call ARRIS Technical Support at **1-877-466-8646** for assistance.

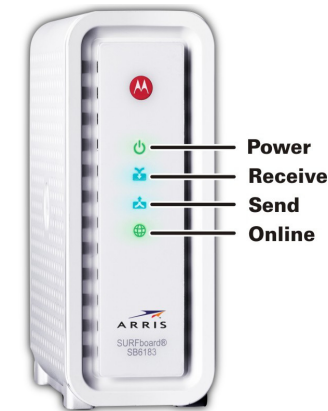

Test the Cable Modem Connection

1. Power ON your computer and log in.

Note: Your service provider may allow for automatic activation which will automatically launch a special website when you open a web browser.

2. Contact your service provider to activate your SB6183, if automatic activation is not available.
3. Open a web browser on your computer, such as Internet Explorer, Google Chrome, Firefox, or Safari.
4. Type a valid URL (such as **www.surfboard.com**) in the address bar and press **Enter** to test your network connection. The ARRIS website should open.

- If the web page opens, your SB6183 was set up properly.
- If the web page fails to open, first check each cable connection on your devices to ensure that they are securely connected. Then, retype the URL.

If still unsuccessful, you may have to contact your current service provider to either set up your Internet service or activate your SB6183.