



# PURE GARDEN











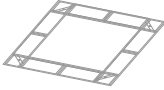
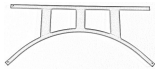

PATIO AND GARDEN ESSENTIALS

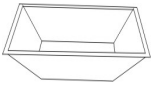
Assembly Instruction – ITEM#50-107

33" SQUARE TILE FIRE PIT WITH COVER

Please check all packing material carefully before discarding, as some parts may be encased in the packing material.

## Part List:

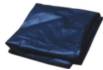
Part List	Description	Qty.	Drawings
A	Top Frame	1	
B	Ladder Frame	4	
C	Corner Post	4	
D	Rectangular Ceramic Tile	8	
E	Square Ceramic Tile	4	
F	Square Bowl	1	
G	Log Grate	1	
H	Mesh Lid	1	
I	Lid Ring	1	
J1	Bolt(M6X16)	16	
J2	Bolt (M6x8)	4	
K	Poker	1	
L	Allen Wrench	1	
M	PVC Cover	1	

Tool required: Allen Wrench (provided)

## Special Warnings

- Check local bylaws before using the fire pit.
- This fire pit is intended for Outdoor Use Only! DO NOT use on wooden decks.
- This fire pit is intended to burn Wood Logs Only! DO NOT burn coal, leaves or other combustible materials in the fire pit.
- NOT for use by children. Keep children and pets away from the fire pit.
- Fire pit is hot, use with caution. NEVER touch hot fire pit with bare hands.
- NEVER leave burning fire pit unattended and always extinguish fire completely before leaving the fire pit.
- Maintain a minimum of 5 FT from any structure.
- DO NOT use near flammable or combustible objects or materials.
- Only CHROMED PLATED COOKING GRID is intended for cooking. LOG GRATE is NOT intended for cooking and SHOULD NOT be used for this purpose.

## Operation Instructions

- Place wood logs on grate and light with match. DO NOT overload logs.
- Please use Poker (provided) when handling.
- We do not recommend pouring water over the fire unless necessary. The fire should be allowed to expire on its own.
- Tile is fragile so handle with care.

## Care and Maintenance

This fire pit is a quality-built product and is made to last for many years. The frame structure of this unit is made of powder-coated steel extrusion and should resist rusting under normal use. Should rusting occur, we suggest using a steel brush on the affected area followed by a spray coating of high temperature anti-rust paint. For additional rust proofing of the bowl, grate and mesh lid we recommend that a coat of high temperature primer (such as rustoleum or similar brand) is applied **before** use. You may cover the fire pit with a Protective Cover (provided) when the fire pit is not in use. Ensure the fire pit has completely cooled down before using the Protective Cover.



### WARNING!

- The use of alcohol, prescription or non-prescription drugs may impair the ability to properly assemble or safely operate this fire pit.
- When using this fire pit, exercise the same precautions you would with any open fire.
- Do not use this fire pit for indoor heating. Toxic carbon monoxide fumes can accumulate and cause asphyxiation or death.

**DO NOT over tighten hardware**

**Step 1)** Attach the Top Frame (A) to the 4pcs of Corner Post (C) by using Bolt (J1). Tighten by hand and do not fully tighten all bolts.

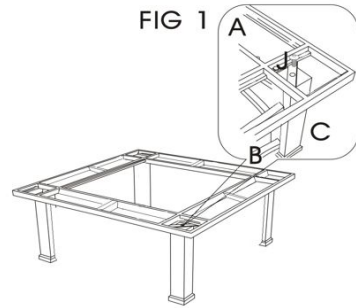

**Step 2)** Attach the Ladder Frame (B) to the Corner Post (C) by using Bolt (J2).



**Step 3)** Tighten all the bolts accordingly with the provided Allen Wrench (L) until all pieces fit together securely after Step 2. Place Long Ceramic Tile (D) and Square Ceramic Tile (E) to the assembled Top Frame (A).



**Step 4)** For Fire Pit use: place Square Bowl (F) on the base, and put Log Grate (G) on the Square Bowl (F).

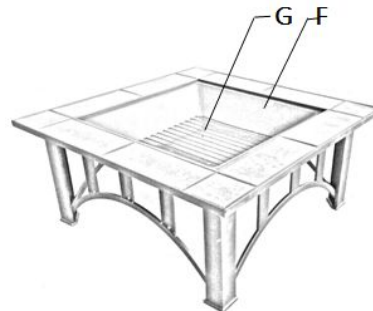

**Step 5)** Screw Lid Ring (I) to the Mesh Lid (H) by screwing the Lid Ring into the upper hole of the Mesh Lid. Then place the Mesh Lid on the Square Bowl (F).

