



OUTDOOR STORAGE

MODEL N° 6417

OWNER'S MANUAL

Copy

Keep this Identification Number in case you need to contact our Customer Service Department.

IMPORTANT! PLEASE READ BEFORE BEGINNING ASSEMBLY

Dear Valued Customer,

We would like to congratulate you on your purchase of a Lifetime© Outdoor Storage Shed! We are confident that you have made the perfect choice and you will be very pleased with your new storage solution.

Lifetime© Outdoor Storage is part of the family of products created and manufactured by Lifetime® Products, Inc. Like all of our products, you can be assured that the quality of your Lifetime Outdoor Storage Shed is the best in the world! And, we back that quality up by offering the best warranty in the business – A 10-year warranty that fully covers the Shed!

All of our Sheds are built with the highest-quality steel and high-density polyethylene (HDPE) parts. The design and construction of our steel-reinforced double-Wall Panels is second to none. All of our exposed steel parts and gables are powder coated and we use high-density polyethylene plastic. What makes polyethylene so special? It has superior strength and durability, and, it won't crack or degrade outdoors.

So now that you know the quality you are getting in a Lifetime Outdoor Storage Shed, please take the time to READ THIS INSTRUCTION MANUAL!

We have taken great care in providing the best possible form of instructions to help you put your new Outdoor Storage Shed together. Before you get started, PLEASE read the following preparation tips to help you get started!

We can assure you, your construction experience will be a lot more enjoyable if you do!

PREPARATION TIPS:

- The first step is simple... RELAX! You have made a great purchase, but Rome was not built in a day. Plan to spend a good part of your weekend putting together your fine Outdoor Storage Shed. Our philosophy is, if it comes together quickly and easily, it surely will come apart quickly and easily! Your Lifetime© Outdoor Storage Shed will surely last a long, long time, if you are patient, and take all the time necessary to put it together as we have instructed.
- Grab a friend to join in on the fun! This is not a one-person endeavor. We have found that not only will things go smoother if you have two or more people participating in the construction of the Shed, but it will go quicker as well. So, the more the merrier!
- Make sure you have all the tools necessary for constructing your new Shed. There is a "Tools Required For This Assembly" list on page five of this Owner's Manual.
- The plastic pieces of your Shed may become damaged by over tightening the screws. To avoid this damage, we strongly recommend the use of a low-powered power screwdriver or a drill that has an adjustable clutch that is set on a low-torque setting. If neither is available, use a hand screwdriver. If a hand screwdriver is all you have, take several breaks... your wrist will need it!
- You will also need two small ladders (when it comes time to do the roof!).

IMPORTANT! PLEASE READ BEFORE BEGINNING ASSEMBLY

- Before beginning assembly, remove the Parts List from the center of this Owner's Manual and take an inventory of the parts included with your Outdoor Storage Shed. Also, read through the entire instruction manual. It's always a great practice to get a feel for the flow of the process and to familiarize yourself with the parts involved. But, try not to get ahead of yourself and start the process out of order.
- FOLLOW THE INSTRUCTIONS IN ORDER! Everything goes together in a certain order, and we have learned what that correct order should be. In our state-of-the-art research and testing facility, we have painstakingly created these instructions. The order of construction is there for a reason, and some parts simply will not fit if built out of order. Just follow along with the order in the instructions and everything will fit together and things will go very smooth.
- YOUR SHED MUST BE BUILT ON A LEVEL SURFACE! If the spot you have chosen to place your wonderful new Outdoor Storage Shed is not level, the Shed will not assemble correctly! We recommend a concrete patio, a wood platform or creating a pad with pea gravel. Your Shed is meant to last a lifetime, so provide the proper foundation for it before you start to build.
- Before you build it, make sure you are allowed to build it! Consult all building codes, as well as city and county ordinances, to ensure that you do not require a building permit to construct your Outdoor Storage Shed. Proper building permit documentation may be required in your neighborhood, and it would be quite unfortunate to learn this after your Outdoor Storage Shed is already built!

Now that you're ready to begin the construction of your wonderful new Outdoor Storage Shed, step back, take a deep breath, get yourself a large cold beverage and enjoy yourself. We guarantee that after spending the right amount of time in building your Shed, you will be able to enjoy it for years to come.

Thanks for choosing Lifetime©, and have fun!

ABOUT LIFETIME PRODUCTS, INC.

Lifetime Products, Inc., has applied innovation and cutting-edge technology in plastics and metals to create a family of affordable lifestyle products that feature superior strength and durability. The world's leading manufacturer of folding tables and chairs, Lifetime was founded in 1986 as the maker of portable basketball systems that revolutionized the industry with patented technology. With diverse offerings such as outdoor storage sheds and steel utility trailers, Lifetime continues to develop innovative products that outfit the way you live.

Lifetime makes the things you need for the lifestyle you want. By innovating products in and around the home, Lifetime simplifies your everyday life and enables you to get the most out of your free time.



REGISTER YOUR LIFETIME PRODUCT TODAY!

There are benefits to registering your Lifetime product. With our new online product registration form, it's fast and easy! Register with us at www.lifetime.com and enjoy these great benefits:

- Receive exclusive money-saving offers from BuyLifetime.com, our online store, as well as NEW product notifications and special closeout promotions!
- In the unlikely event of a product recall or safety modification, we will notify you.
- Registering your product guarantees you warranty service. If you do not register your product, your warranty rights will not be diminished. But you will need to provide a sales receipt to verify your product purchase date before warranty service will be provided.

LIFETIME'S PROMISE TO YOU:

Maintaining your privacy is our long-standing policy at Lifetime. And you can rest assured that Lifetime will not sell or provide your personal data to other third parties, or allow them to use your personal data for their own purposes.

We invite you to read our privacy policy at www.lifetime.com

REGISTER today!

****U.S. and Canada customers ONLY****

IF ASSISTANCE IS NEEDED,

DO NOT CONTACT THE STORE!

CALL OUR CUSTOMER SERVICE DEPARTMENT at 1 (800) 225-3865

HOURS: 7:00 a.m. to 5:00 p.m. Monday through Friday (Mountain Standard Time)

Call, or visit our Web site for Saturday hours

For customers outside the U.S. or Canada, please contact the store for assistance.



SAFETY INSTRUCTIONS



FAILURE TO FOLLOW THESE WARNINGS MAY RESULT IN SERIOUS INJURY OR PROPERTY DAMAGE AND WILL VOID WARRANTY.

To ensure safety, do not attempt to assemble this product without following the instructions carefully. Check entire box and inside all packing material for parts and/or additional instruction material. Before beginning assembly, read the instructions and identify parts using the hardware identifier and parts list in this document. Proper and complete assembly, use and supervision are essential to reduce the risk of accident or injury.

- Do not use or store hot objects such as grills, blowtorches, welding equipment, etc. near the product.
- If using a ladder during assembly, use extreme caution.
- Two capable adults are required for assembly. (It is also recommended that a third adult function as an instruction reader.)

Most injuries are caused by misuse and/or not following instructions. Use caution when using this product.

BEFORE BEGINNING ASSEMBLY



Keep the hardware bags and their contents separate. If any parts are missing, call our Customer Service Department.



Read the “Congratulations” letter on page 2-3. Identify and inventory all parts and hardware using the parts and hardware lists and identifiers in this document.

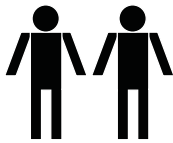













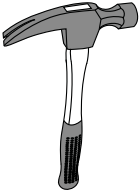



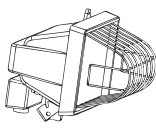

****Two adults required to complete assembly****

Only adults should set up the product. Do not allow children in the set-up area until assembly is complete.

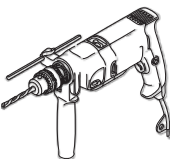

TOOLS REQUIRED FOR THIS ASSEMBLY

7/16"	3/8"	Adjustable Wrench	Rubber Mallet	Hammer	Box Knife	Phillips Screwdriver	Plain Screwdriver	3/8" Masonry Drill Bit	2" x 4" x 11' Leveling Board
									
(2)	(1)	(1)	(1)	(1)	(1)	(1)	(1)	(1)	
Ladder	Electric Drill	Work Light	Pliers	Flashlight	Hammer Drill	Safety Glasses			
									
(2)	(1)	(1)	(1)	(1)	(1)	(1 pair for each person)		(1)	(1)

*Read the “Screwdriver Notice” on page 7.

ASSEMBLY GUIDES

Refer to the following areas throughout the instructions to assist in the assembly process:

This area is located at the top, left-hand corner of the page and indicates which tools and hardware are needed to complete the assembly steps on a page.



TOOLS AND HARDWARE REQUIRED FOR THIS PAGE

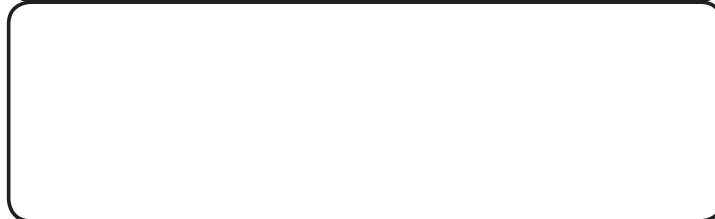

This area is located at the top, right-hand corner of the page and shows an image of the product with shaded parts indicating which section is being assembled.



This area is usually located in the bottom, left-hand corner of a step and indicates that special attention is needed to perform a particular part of a step.



Note:

These areas are usually located in the bottom, right-hand corner of a step and indicate that damage to the product or serious injury may occur if the caution or warning is not heeded.



CAUTION



WARNING

Throughout the Parts & Hardware List, Part & Hardware Identifiers, and instructions are three-letter IDs. These IDs are below the images of the parts and hardware to help you locate and identify the parts and hardware during assembly. These IDs are not necessarily on the parts themselves.

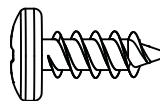

ADZ (x10)
1/4" x 5/8" Pan-Head Screw

IMPORTANT NOTICES

Level Surface Notice:

Surface must be leveled before installation. We recommend building a level work space with a concrete or patio style surface. If the surface is not properly leveled, the Outdoor Shed will not assemble correctly. Proper surface leveling will save you time in the long run, so please do not ignore this step.

Building Code Notice:

Consult all local building codes, as well as city and county ordinances, to ensure that the construction of the Outdoor Shed does not require a building permit. Proper building permit documentation may be required in your neighborhood, and it would be unfortunate to learn this after constructing the Shed.

Screwdriver Notice:

You may use a #2 Phillips head screwdriver bit and a power screwdriver or drill, instead of a hand screwdriver. However, be aware that the plastic pieces of your Shed can be damaged by overtightening of screws. To avoid damage we strongly recommend the use of a low-powered power screwdriver or a drill that has an adjustable clutch that is set on a low torque setting. If neither is available, use a hand screwdriver. In any case use caution to avoid overtightening the screws.

Floor Puncture Notice:

Sharp objects may damage your floor. If resting sharp, heavy objects on your Shed floor, place a block of wood between the sharp object and floor.



CAUTION:

If more than six (6) inches of snow accumulate on the roof of the shed, carefully remove the snow to avoid possible roof collapse. While standing on the ground, remove the snow from the roof with a broom or snow shovel. Do not stand on the roof to remove snow.

Snow Load Kit available from Customer Service for high snow areas.

PARTS & HARDWARE LIST

BOX 1

ID	Description	Qty
AGI	Right Gable	2
AGH	Left Gable	2
AGU	Outer Roof Panel A	2
AGV	Outer Roof Panel B	2
AGS	Outer Floor Panel A	2
AGT	Outer Floor Panel B	2
AGE	End Roof Cap	2
AFT	14" x 30" Shelf	2
AFB	Door Brace	8
BLG	Extended Door Brace	1
BLI	Corner Frame Bracket	2
AFF	Gable Truss Brace	2

BNM METAL PARTS KIT 1

BLK	Left Hinge Assembly	1
BMG	Right Hinge Assembly	1
BKZ	Center Hinge Assembly	1

BNN METAL PARTS KIT 2

AFQ	Wall Support Channel	6
AFJ	Long Vertical Extension Channel	2
AFN	Short Vertical Extension Channel	2
AFH	Truss Gutter Channel	2
AFR	Corner Channel	2
AFG	Truss Brace Channel	1
BLH	Extended Door End Channel	2
AFP	Truss Support Strip	2
BLL	Long Glider Track	1
BLM	Short Glider Track	1
BLN	Glider Track Extension	1

BOX 2

AFY	Center Roof Cap	2
AGQ	Center Roof Panel	3
AHB	Roof Panel for Skylight	1
AHD	Wall Panel	3
AGB	Domed Skylight	1
AHH	Window Wall Panel	1
AHG	Window Frame	2
AGJ	Inner Floor Panel	4
AHF	Window	2
AFL	Roof Support Strip	14

BNL METAL PARTS KIT 1

AFP	Truss Support Strip	4
AFH	Truss Gutter Channel	4
AFG	Roof Truss Brace	2

BNK METAL PARTS KIT 2

AFQ	Wall Support Channel	4
-----	----------------------	---

BNJ HARDWARE BOX

BNI TRUSS FRAME & WALL SUPPORT INSTALLATION HARDWARE

ADZ	1/4" x 5/8" Pan-Head Screw	110
ADJ	1/4" Cap Nut	20
AAK	1/4" x 1 1/2" Hex Bolt	20
AHT	Floor Bracket	8
ACD	#10 x 3/8" Flat-Head Screw	4
ADK	#10 Cap Nut	4

BGV TRUSS FRAME ASSEMBLY HARDWARE (x4)

AIP	Truss Connector	1
AAK	1/4" x 1.5" Hex Bolt	10
ADJ	1/4" Cap Nut	10
AHT	Floor Bracket	2

ID	Description	Qty
BNH GABLE BRACE & ROOF INSTALLATION HARDWARE		
ADZ	1/4" x 5/8" Pan-Head Screw	185
AED	#10 x 1" Fender Washer	16
ACJ	#10 x 5/8" Pan-Head Screw	16
AJA	Foam Cube	20
ADX	#10 x 1/2" Pan-Head Screw	4
ACF	#10 x 5/16" Pan-Head Screw	1
ADK	#10 Cap Nut	1

BOX 3

AFY	Center Roof Cap	1
AGQ	Center Roof Panel	1
AHB	Roof Panel for Skylight	1
AGB	Domed Skylight	1
AHH	Window Wall Panel	1
AHD	Wall Panel	1
AHG	Window Frame	2
AGJ	Inner Floor Panel	2
AHF	Window	2
AFL	Roof Support Strip	6

BNG METAL PARTS KIT 1

AFG	Roof Truss Brace	1
AFH	Truss Gutter Channel	2

BNF METAL PARTS KIT 2

AFP	Truss Support Strip	2
AFQ	Wall Support Channel	2

BNB HARDWARE BOX

BGU WINDOW ASSEMBLY & INSTALLATION HARDWARE (x2)

ADZ	1/4" x 5/8" Pan-Head Screw	4
ADW	#10 x 3/4" Pan-Head Screw	4
ADX	#10 x 1/2" Pan-Head Screw	22
AEE	#10 x 1/2" Flat Washer	2
ACF	#10 x 5/16" Pan-Head Screw	2
ACB	#10 x 1 1/4" Pan-Head Screw	4
ADK	#10 Cap Nut	2
ACD	#10 x 3/8" Flat Head Screw	2
AIV	Window Stay Bracket	2
AIE	Mounted Window Stay	2
AIN	Sliding Window Stay	2
AIR	Window Hinge	4
AIT	Window Latch	4
AIU	Window Latch Bearing	4

BEC DOMED SKYLIGHT ASSEMBLY HARDWARE (x2)

ACR	#10 x 5/8" Carriage Bolt	12
AEE	#10 x 1/2" Flat Washer	12
ADK	#10 Cap Nut	12
AHI	Butyl Tape	1

BOX 4

AHD	Wall Panel	6
BLJ	Corner Door Frame	2
AQX	Corner Trim	4

BNO Parts & Hardware Box

AHA	Roof Cap Cover	2
AFU	Pegboard Strip	2
AIZ	14" Shelf Bracket	4

BHC PEGBOARD STRIP INSTALLATION HARDWARE

ADW	#10 x 3/4" Pan-Head Screw	10
-----	---------------------------	----

BHD Tool Clip Assortment

AIH	Pegboard J-Hook	3
AII	Pegboard L-Hook	3
AIJ	Pegboard Toolholder	2
AIF	Pegboard 2" Double Arm Hook	1
AIG	Pegboard 4" Double Arm Hook	1

PARTS & HARDWARE LIST (CONT.)

ID	Description	Qty	ID	Description	Qty
BNA GABLE ASSEMBLY HARDWARE (x2)			BNE DOOR FRAME & DOOR INSTALLATION HARDWARE		
AGP	Louvered Vent	1	ADX	#10 x 1/2" Pan-Head Screw	4
AIQ	Vent Screen	1	ACA	1/4" x 1/2" Carriage Bolt	8
ADW	#10 x 3/4" Pan-Head Screw	5	ADJ	1/4" Cap Nut	16
AEE	#10 x 1/2" Flat Washer	5	ADZ	1/4" x 5/8" Pan-Head Screw	13
ADZ	1/4" x 5/8" Pan-Head Screw	4	AEB	1/4" Flat Washer	8
BMZ GABLE INSTALLATION HARDWARE			BBE	Glider Wheel	2
ADZ	1/4" x 5/8" Pan-Head Screw	30	BBF	1/4" x 5x16" x 1/2" Shoulder Screw	2
BMX WALL INSTALLATION HARDWARE			ABU	1/4" x 1 1/2" Carriage Bolt	6
ADZ	1/4" x 5/8" Pan-Head Screw	116	BBG	5/16" x 2 1/2" Hex Bolt	1
ADC	#2 Phillips Bit	1	AAV	5/16" Jam Nut	2
BMY 14" SHELF INSTALLATION HARDWARE (x2)			BBJ	4" Floor Strike Plate	1
ADX	#10 x 1/2" Pan-Head Screw	4	BBK	Carriage Bracket	1
AEE	#10 x 1/2" Flat Washer	4	BBL	1/4" x 3/4" Hex Bolt	6
BMW LEFT DOOR HARDWARE			BBM	1/4" x 1/2" Thread-Cutting Screw	4
ADZ	1/4" x 5/8" Pan-Head Screw	9	BBN	Carriage Latch	1
ABU	1/4" x 1 1/2" Carriage Bolt	2	AHL	Dead Bolt Strike Plate	2
ADJ	1/4" Cap Nut	2	CJR	Door Frame Support Bracket	2
AHM	Deadbolt Latch	2	AID	L-Key with Phillips Head	1
AEB	1/4" Flat Washer	2	BNC DOOR WINDOW INSTALLATION HARDWARE		
BMV CENTER DOOR HARDWARE			ADZ	1/4" x 5/8" Pan-Head Screw	39
ADW	#10 x 3/4" Pan-Head Screw	3	BOX 5		
ADX	#10 x 1/2" Pan-Head Screw	2	AGZ	Right & Center Door	2
AEE	#10 x 1/2" Flat Washer	1	AGO	Left Door	1
BLA	Inside Handle	1	BLO	Door Window	3
AHZ	Center Handle	1			
BQP	1/4" x 1 1/4" Carriage Bolt	2			
ADJ	1/4" Cap Nut	2			
AIA	Center Door Lock Bracket	1			
AIB	Center Door Extended Strike Plate	1			
ADZ	1/4" x 5/8" Pan-Head Screw	9			
AHM	Deadbolt Latch	1			
BBH	End Plug	2			
BMU RIGHT DOOR HARDWARE					
ADZ	1/4" x 5/8" Pan-Head Screw	9			
AEE	#10 x 1/2" Flat Washer	3			
ADW	#10 x 3/4" Pan-Head Screw	4			
BQQ	1/4" x 2 1/4" Carriage Bolt	2			
AHY	Latch Spring	1			
AHW	Thumb Lever Extension	1			
AEB	1/4" Flat Washer	2			
ADJ	1/4" Cap Nut	2			
ADB	3/8" x .64" Steel Spacer	2			
AIL	Right Door Lock Bracket	1			
AHV	Extended Door Latch	1			
AHX	Latch Cover Plate	1			
AIO	Thumb Lever	1			
AIK	Right Handle	1			
BND TRIM INSTALLATION HARDWARE					
ACK	#8 x 1" Pan-Head Screw	4			
ADX	#10 x 1/2" Pan-Head Screw	34			
AGA	Black, Plastic Corner Trim Bracket	12			
BMH	Metal Corner Trim Bracket	10			

! *Note: Throughout the Parts & Hardware List, Part & Hardware Identifiers, and instructions are three-letter IDs. These IDs are below the images of the parts and hardware to help you locate and identify the parts and hardware during assembly. These IDs are not necessarily on the parts themselves.*

PARTS & HARDWARE IDENTIFIER

BOX 1

Parts shown at 8% of actual size

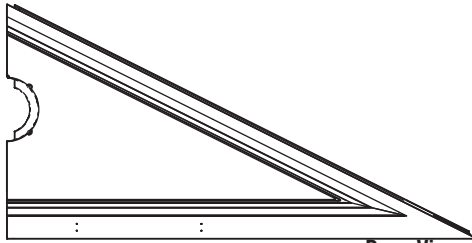

AGH (x2)
Left Gable

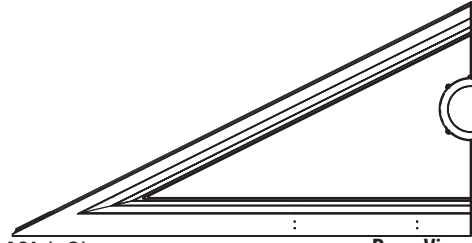

AGI (x2)
Right Gable

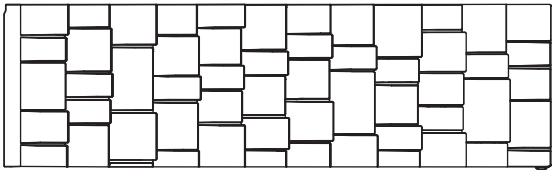

AGU (x2)
Outer Roof Panel A

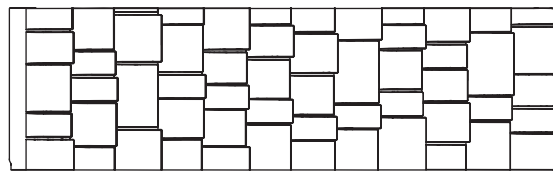

AGV (x2)
Outer Roof Panel B

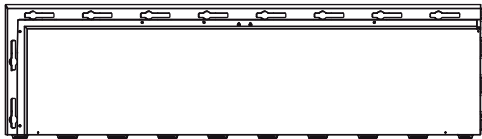

AGS (x2)
Outer Floor Panel A

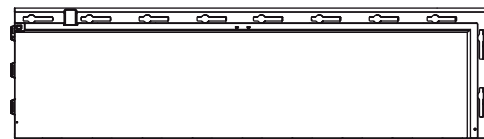

AGT (x2)
Outer Floor Panel B



AFB (x8)
Door Brace

26 1/4"



BLG (x1)
Extended Door Brace

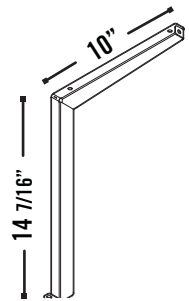

AFF (x2)
Gable Truss Brace

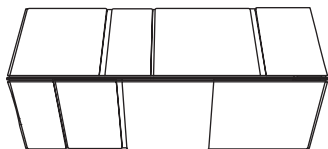

AGE (x2)
End Roof Cap

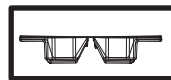

Part shown at 15% of actual size

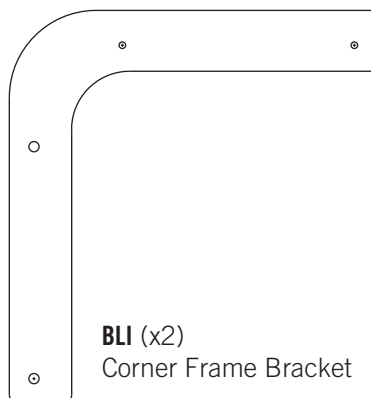

BLI (x2)
Corner Frame Bracket

Part shown at 4% of actual size



AFT (x2)
14" x 30" Shelf

PARTS & HARDWARE IDENTIFIER

BOX 1 (CONT.)

METAL PARTS KIT 1 [BNM]

Parts shown at 8% of actual size

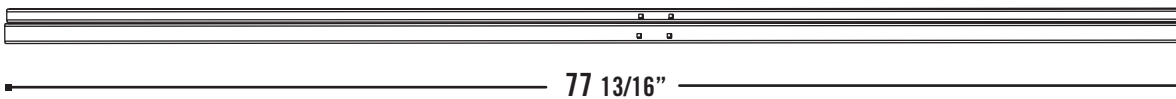

BKZ (x1)
Center Hinge Assembly

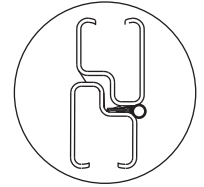

BMG (x1)
Right Hinge Assembly

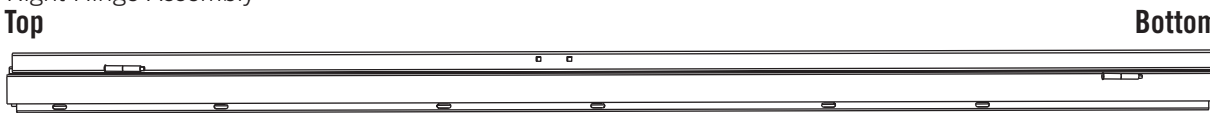
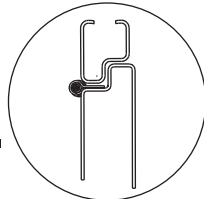

BLK (x1)
Left Hinge Assembly

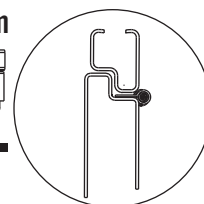

METAL PARTS KIT 2 [BNN]

Parts shown at 8% of actual size

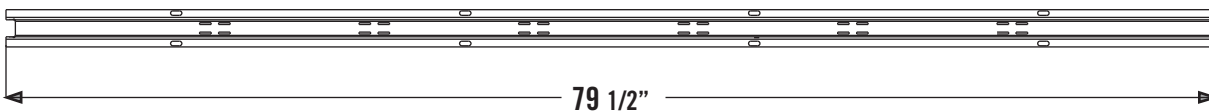

AFQ (x6)
Wall Support Channel

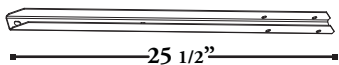
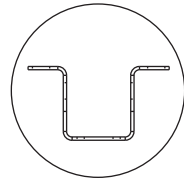

AFJ (x2)
Long Vertical Extension Channel

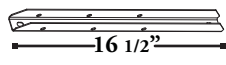

AFN (x2)
Short Vertical Extension Channel

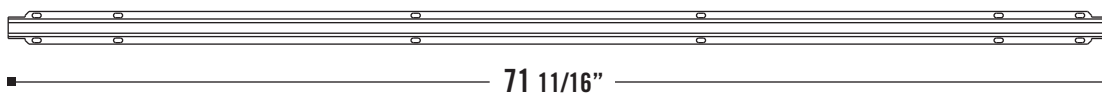

AFH (x2)
Truss Gutter Channel

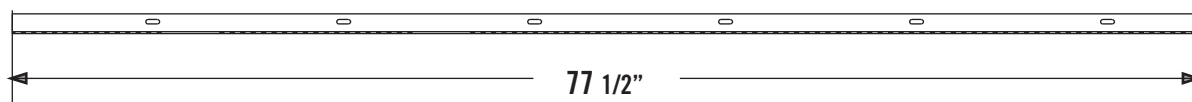
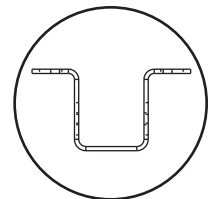

AFR (x2)
Corner Channel

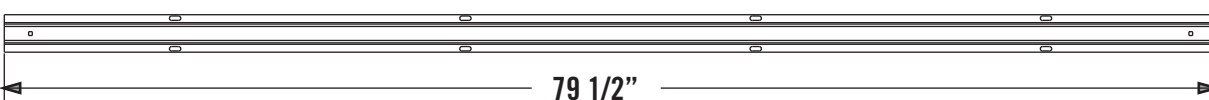
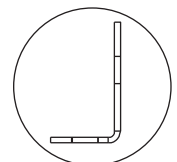

AFG (x1)
Truss Brace Channel

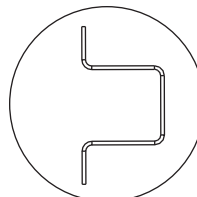

PARTS & HARDWARE IDENTIFIER

BOX 1 (CONT.)

Parts shown at 8% of actual size

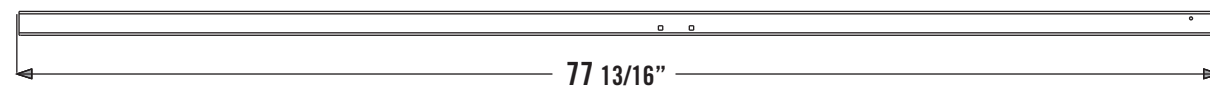

BLH (x2)
Extended Door End Channel

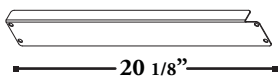

AFP (x2)
Truss Support Strip

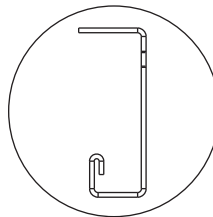
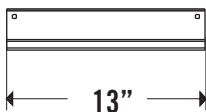

BLM (x1)
Short Glider Track



BLL (x1)
Long Glider Track

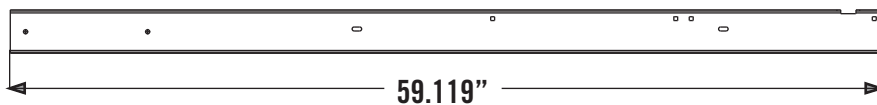
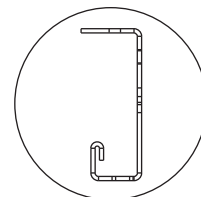

BLN (x1)
Glider Track Channel

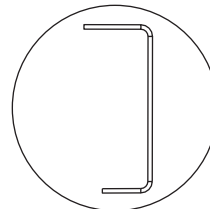

BOX 2

Parts shown at 4% of actual size

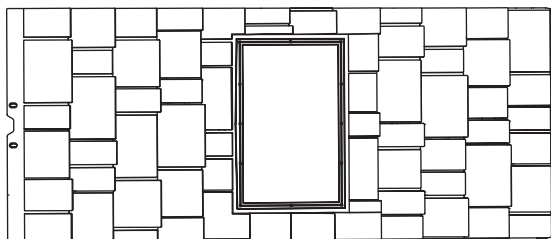

AHB (x1)
Roof Panel for Skylight

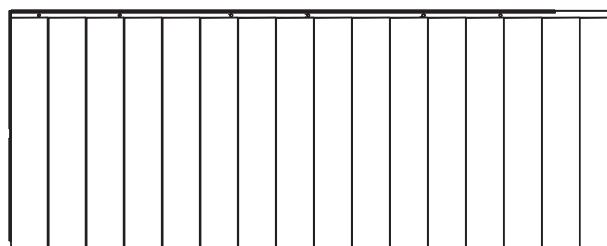

AHD (x3)
Wall Panel

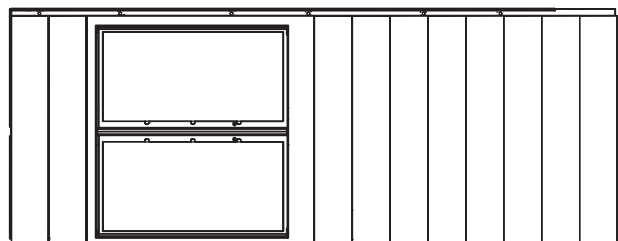

AHH (x1)
Window Wall Panel



AGJ (x4)
Inner Floor Panel

PARTS & HARDWARE IDENTIFIER

BOX 2

Parts shown at 4% of actual size

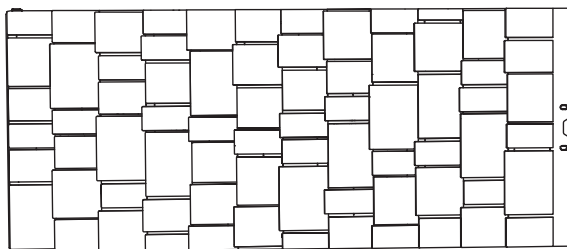

AGQ (x3)
Center Roof Panel

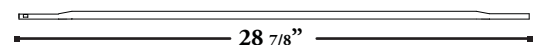

AFL (x14)
Roof Support Strip

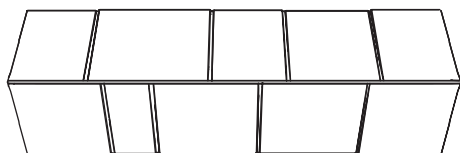

AFY (x2)
Center Roof Cap

Parts shown at 8% of actual size

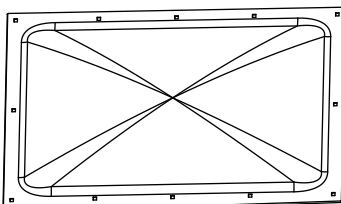

AGB (x1)
Domed Skylight

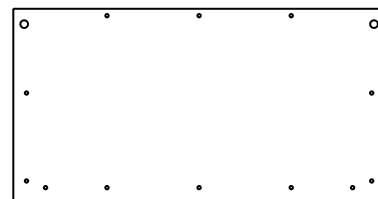

AHF (x2)
Window

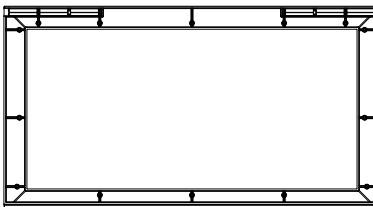

AHG (x2)
Window Frame

METAL PARTS KIT 1 [BNL]

Parts shown at 8% of actual size

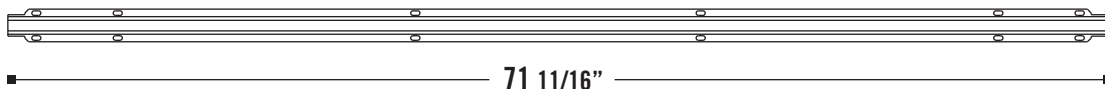

AFH (x4)
Truss Gutter Channel

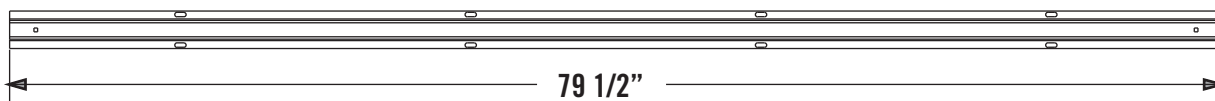
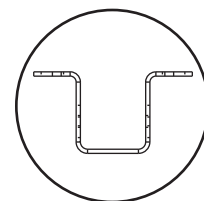

AFG (x2)
Roof Truss Brace

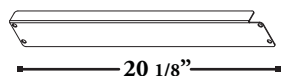
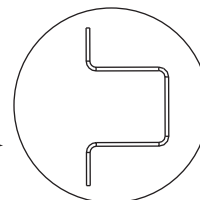

AFP (x4)
Truss Support Strip

METAL PARTS KIT 2 [BNK]

Part shown at 8% of actual size

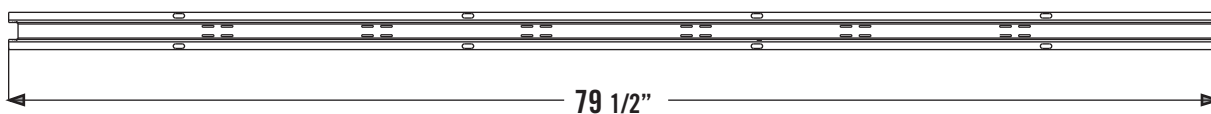

AFQ (x4)
Wall Support Channel

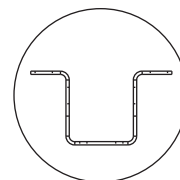

PARTS & HARDWARE IDENTIFIER

BOX 2 (CONT.)

HARDWARE BOX [BNJ]

TRUSS FRAME & WALL SUPPORT INSTALLATION HARDWARE [BNI]

Hardware shown at actual size (*Unless otherwise noted)

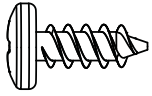

ADZ (x110)
1/4" x 5/8" Pan-Head Screw



ADJ (x20)
1/4" Cap Nut

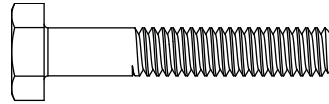

AAK (x20)
1/4" x 1 1/2" Hex Bolt



AHT (x8)*
Floor Bracket

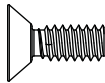

ACD (x4)
#10 x 3/8" Flat-Head Screw



ADK (x4)
#10 Cap Nut

TRUSS FRAME ASSEMBLY HARDWARE [BGV] (x4)

Hardware shown at actual size (*Unless otherwise noted)

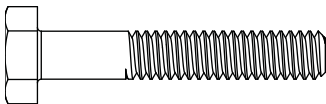

AAK (x10)
1/4" x 1 1/2" Hex Bolt



ADJ (x10)
1/4" Cap Nut



AHT (x2)*
Floor Bracket

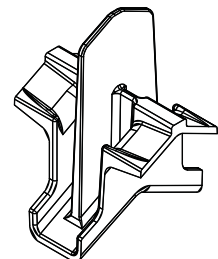

AIP (x1)*
Truss Connector

GABLE BRACE & ROOF INSTALLATION HARDWARE [BNH]

Hardware shown at actual size (*Unless otherwise noted)

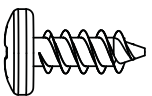

ADZ (x185)
1/4" x 5/8" Pan-Head Screw
(Not all are used)

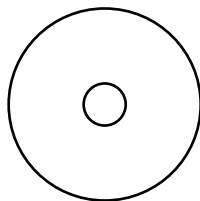

AED (x16)
#10 x 1" Fender Washer

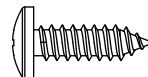

ACJ (x16)
#10 x 5/8" Pan-Head Screw

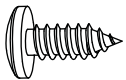

ADX (x4)
#10 x 1/2" Pan-Head Screw



ACF (x1)
#10 x 5/16" Pan-Head Screw



ADK (x1)
#10 Cap Nut

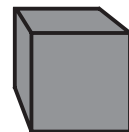

AJA (x20)*
Foam Cube

PARTS & HARDWARE IDENTIFIER

BOX 3

Parts shown at 4% of actual size

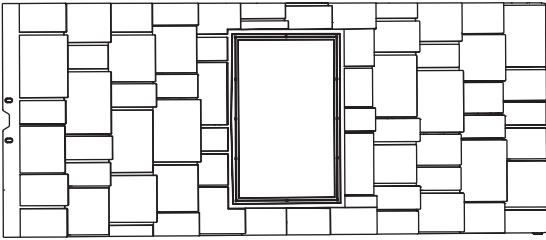

AHB (x1)
Roof Panel for Skylight

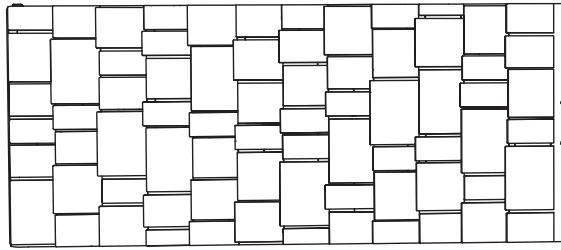

AGQ (x1)
Center Roof Panel

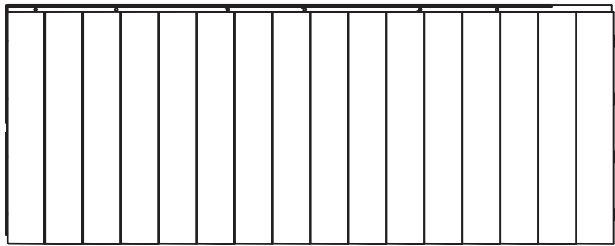

AHD (x1)
Wall Panel

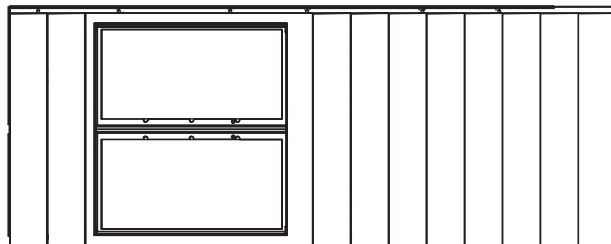

AHH (x1)
Window Wall Panel



AGJ (x2)
Inner Floor Panel

Parts shown at 8% of actual size

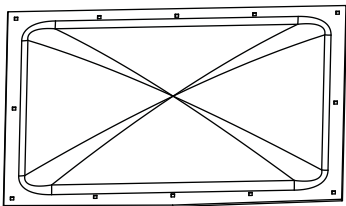

AGB (x1)
Domed Skylight

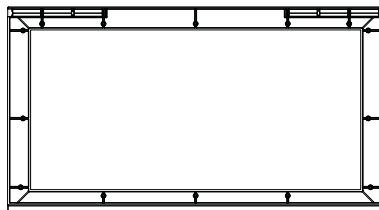

AHG (x2)
Window Frame

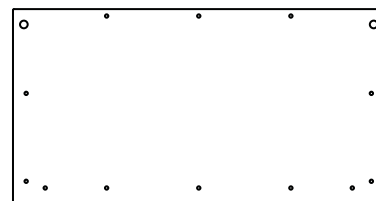

AHF (x2)
Window

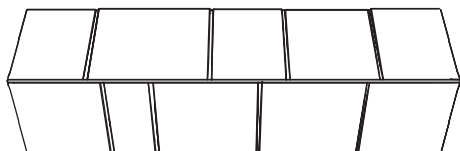

AFY (x1)
Center Roof Cap

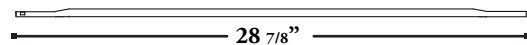

AFL (x6)
Roof Support Strip

PARTS & HARDWARE IDENTIFIER

BOX 3 (CONT.)

METAL PARTS KIT 1 [BNG]

Parts shown at 8% of actual size

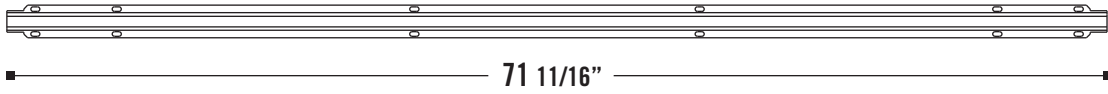

AFH (x2)
Truss Gutter Channel

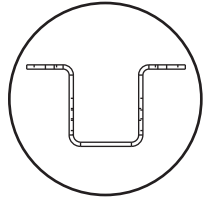

AFG (x1)
Roof Truss Brace

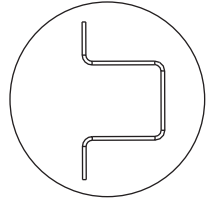

METAL PARTS KIT 2 [BNF]

Part shown at 8% of actual size

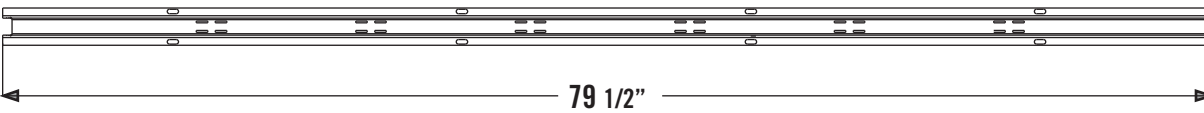

AFQ (x2)
Wall Support Channel

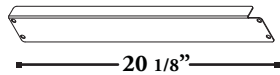
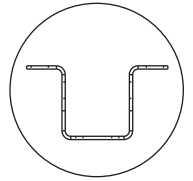

AFP (x2)
Truss Support Strip

HARDWARE BOX [BNB]

WINDOW ASSEMBLY & INSTALLATION HARDWARE [BGU] (x2)

Hardware shown at actual size

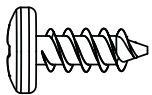

ADZ (x4)
1/4" x 5/8" Pan-Head Screw

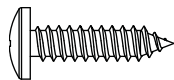

ADW (x4)
#10 x 3/4" Pan-Head Screw

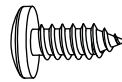

ADX (x22)
#10 x 1/2" Pan-Head Screw

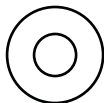

AAE (x2)
#10 x 1/2" Flat Washer



ACF (x2)
#10 x 5/16" Pan-Head Screw

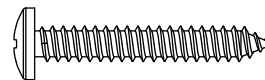

ACB (x4)
#10 x 1 1/4" Pan-Head Screw

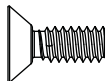

ACD (x2)
#10 x 3/8" Flat-Head Screw
(Not used in this model)



ADK (x2)
#10 Cap Nut
(Not used in this model)

PARTS & HARDWARE IDENTIFIER

BOX 3 (CONT.)

WINDOW ASSEMBLY & INSTALLATION HARDWARE [BGU] (x2) (CONT.)

Parts shown at 25% of actual size

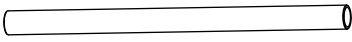

AIR (x4)
Window Hinge

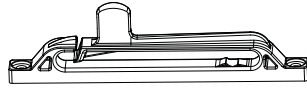

AIE (x2)
Mounted Window Stay



AIN (x2)
Sliding Window Stay

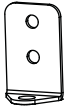

AIV (x2)
Window Stay
Bracket

Parts shown at 50% of actual size

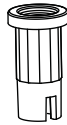

AIU (x4)
Window Latch Bearing

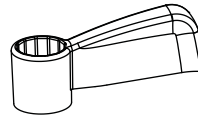

AIT (x4)
Window Latch

DOMED SKYLIGHT ASSEMBLY HARDWARE BAG [BEC] (x2)

Hardware shown at actual size (*unless otherwise noted)

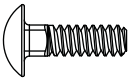

ACR (x12)
#10 x 5/8" Carriage Bolt



ADK (x12)
#10 Cap Nut

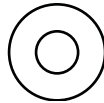

AEE (x12)
#10 x 1/2" Flat Washer



AHI (x1)
Butyl Tape

BOX 4

Part shown at 4% of actual size

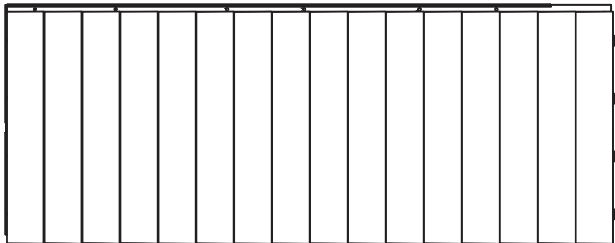

AHD (x6)
Wall Panel

Part shown at 4% of actual size

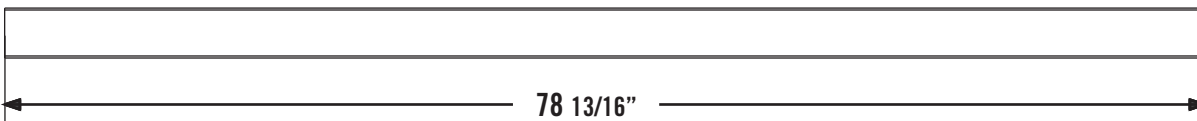

AQX (x4)
Corner Trim

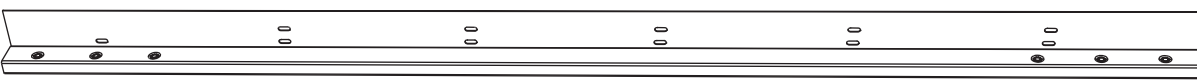
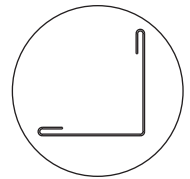

BLJ (x2)
Corner Door Frame

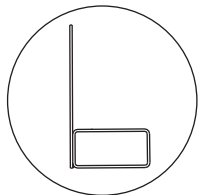

PARTS & HARDWARE IDENTIFIER

BOX 4 (CONT.)

PARTS & HARDWARE BOX [BNO]

Parts shown at 15% of actual size

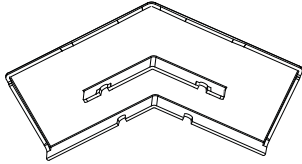

AHA (x2)
Roof Cap Cover

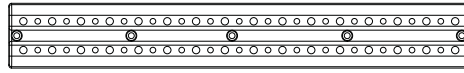

AFU (x2)
Pegboard Strip



AIZ (x4)
14" Shelf Bracket

PEGBOARD STRIP INSTALLATION HARDWARE [BHC]

Hardware shown at actual size

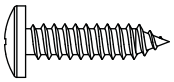

ADW (x10)
#10 x 3/4" Pan-Head Screw

TOOL CLIP ASSORTMENT [BHD]

Parts shown at 50% of actual size

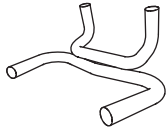

AIJ (x2)
Toolholder

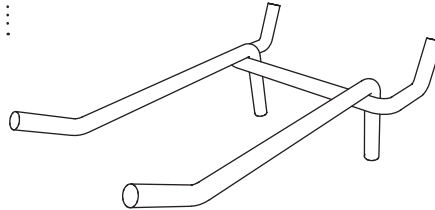

AIF (x1)
2" Double-Arm Hook

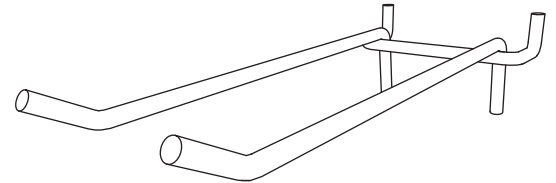

AIG (x1)
4" Double-Arm Hook

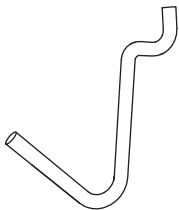

AIH (x3)
J-Hook

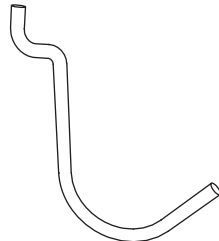

AII (x3)
L-Hook

GABLE ASSEMBLY HARDWARE [BNA] (x2)

Hardware shown at actual size

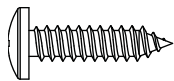

ADW (x5)
#10 x 3/4" Pan-Head Screw

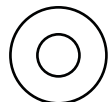

AEE (x5)
#10 x 1/2" Flat Washer

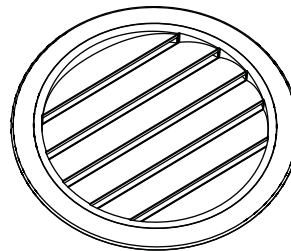

AGP (x1)
Louvered Vent

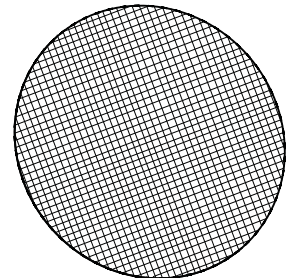

AIQ (x1)
Vent Screen

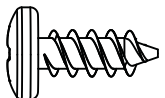

ADZ (x4)
1/4" x 5/8" Pan-Head Screw

PARTS & HARDWARE IDENTIFIER

BOX 4 (CONT.)

GABLE INSTALLATION HARDWARE [BMZ]

Hardware shown at actual size

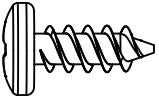

ADZ (x30)
1/4" x 5/8" Pan-Head Screw

WALL INSTALLATION HARDWARE [BMX]

Hardware shown at actual size

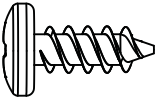

ADZ (x116)
1/4" x 5/8" Pan-Head Screw



ADC (x1)
#2 Phillips Bit

14" SHELF INSTALLATION HARDWARE [BMY] (x2)

Hardware shown at actual size

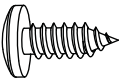

ADX (x4)
#10 x 1/2" Pan-Head Screw

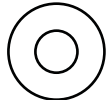

AEE (x4)
#10 x 1/2" Flat Washer

LEFT DOOR HARDWARE [BMW]

Hardware shown at actual size (*Unless otherwise noted)

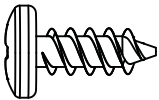

ADZ (x9)
1/4" x 5/8" Pan-Head Screw

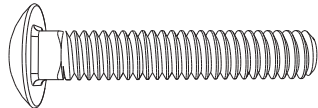

ABU (x2)
1/4" x 1 1/2" Carriage Bolt



ADJ (x2)
1/4" Cap Nut

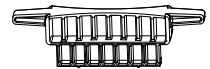

AHM (x2)
Dead Bolt Latch

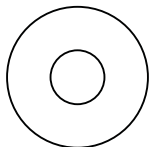

AEB (x2)
1/4" Flat Washer

PARTS & HARDWARE IDENTIFIER

BOX 4 (CONT.)

CENTER DOOR HARDWARE [BMV]

Hardware shown at actual size

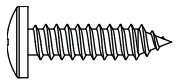

ADW (x3)
#10 x 3/4" Pan-Head Screw

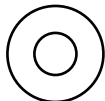

AEE (x1)
#10 x 1/2" Flat Washer

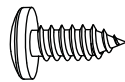

ADX (x2)
#10 x 1/2" Pan-Head Screw



ADJ (x2)
1/4" Cap Nut

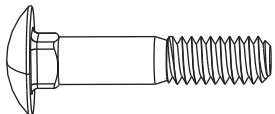

BQP (x2)
1/4" x 1 1/4" Carriage Bolt

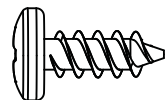

ADZ (x9)
1/4" x 5/8" Pan-Head Screw

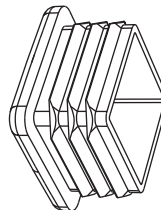

BBH (x2)
End Plug

Hardware shown at 50% of actual size

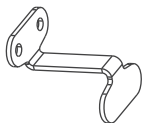

BBI (x1)
Inside Handle

Hardware shown at 15% of actual size



AHZ (x1)
Center Handle

Hardware shown at 25% of actual size



AIA (x1)
Center Door Lock Bracket

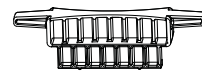

AHM (x1)
Dead Bolt Latch

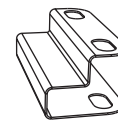

AIB (x1)
Center Door Extended Strike Plate

RIGHT DOOR HARDWARE [BMU]

Hardware shown at actual size

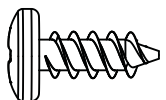

ADZ (x9)
1/4" x 5/8" Pan-Head Screw

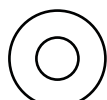

AEE (x3)
#10 x 1/2" Flat Washer

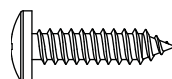

ADW (x4)
#10 x 3/4" Pan-Head Screw

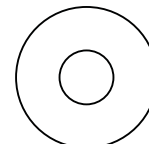

AEB (x2)
1/4" Flat Washer

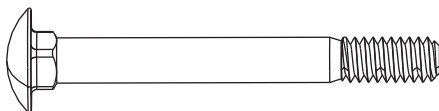

BQQ (x2)
1/4" x 2 1/4" Carriage Bolt



ADB (x2)
3/8" x .64 Steel Spacer

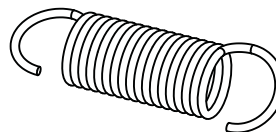

AHY (x1)
Latch Spring



ADJ (x2)
1/4" Cap Nut

Parts shown at 25% of actual size

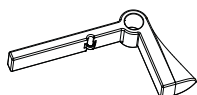

AHV (x1)
Extended Door Latch

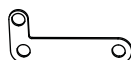

AHX (x1)
Latch Cover Plate

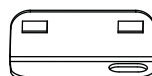

AIL (x1)
Right Door Lock Bracket

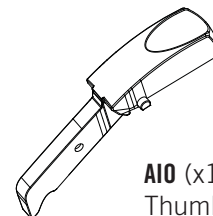

AIO (x1)
Thumb Lever

PARTS & HARDWARE IDENTIFIER

BOX 4 (CONT.)

RIGHT DOOR HARDWARE [BMU] (CONT.)

Hardware shown at 15% of actual size

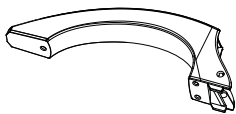

AIK (x1)
Right Door Handle

Hardware shown at 50% of actual size

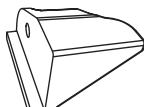

AHW (x1)
Thumb Lever Extension

TRIM INSTALLATION HARDWARE [BND]

Hardware shown at actual size

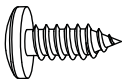

ADX (x34)
#10 x 1/2" Pan-Head Screw



ACK (x4)
#8 x 1" Pan-Head Screw

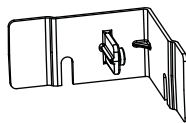

AGA (x12)
Black, Plastic Corner Trim Bracket

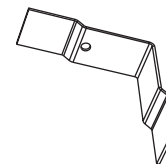

BMH (x10)
Metal Corner Trim Bracket

DOOR FRAME & DOOR INSTALLATION HARDWARE [BNE]

Hardware shown at actual size

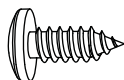

ADX (x4)
#10 x 1/2" Pan-Head Screw

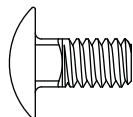

ACA (x8)
1/4" X 1/2" Carriage Bolt



ADJ (x16)
1/4" Cap Nut

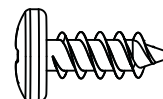

ADZ (x13)
1/4" x 5/8" Pan-Head Screw

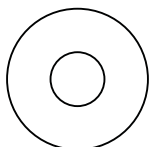

AEB (x8)
1/4" Flat Washer

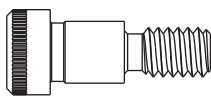

BBF (x2)
1/4" x 5/16" x 1/2" Shoulder Screw

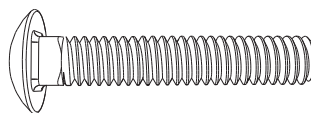

ABU (x6)
1/4" x 1 1/2" Carriage Bolt

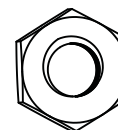

AAV (x2)
5/16" Jam Nut

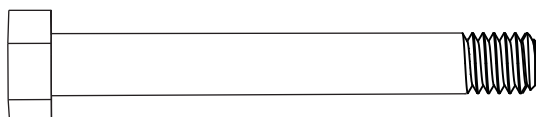

BBG (x1)
5/16" x 2 1/2" Hex Bolt

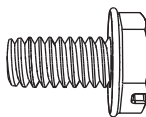

BBM (x4)
1/4" x 1/2" Thread Cutting Screw

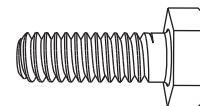

BBL (x6)
1/4" x 3/4" Hex Bolt

AID (x1)
L-Key with Phillips Head

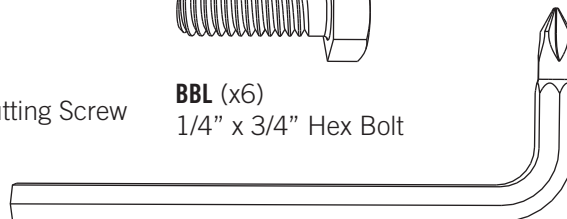

Hardware shown at 50% of actual size



BBJ (x1)
4" Floor Strike Plate

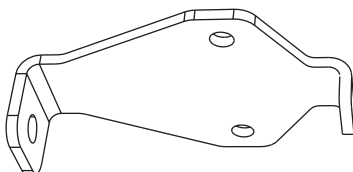

BBK (x1)
Carriage Bracket

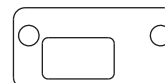

AHL (x2)
Dead Bolt Strike Plate

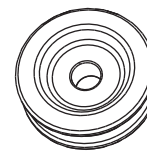

BBE (x2)
Glider Wheel

PARTS & HARDWARE IDENTIFIER

BOX 4 (CONT.)

DOOR FRAME & DOOR INSTALLATION HARDWARE [BNE] (CONT.)

Hardware shown at 50% of actual size

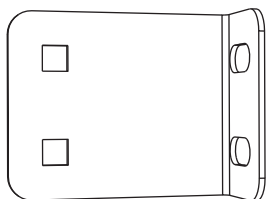

CJR (x2)
Door Frame Support Bracket

Hardware shown at 25% of actual size

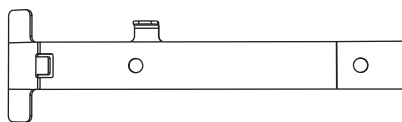

BBN (x1)
Carriage Latch

DOOR WINDOW INSTALLATION HARDWARE [BNC]

Hardware shown at actual size

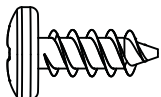

ADZ (x39)
1/4" x 5/8" Pan-Head Screw

BOX 5

Parts shown at 4% of actual size

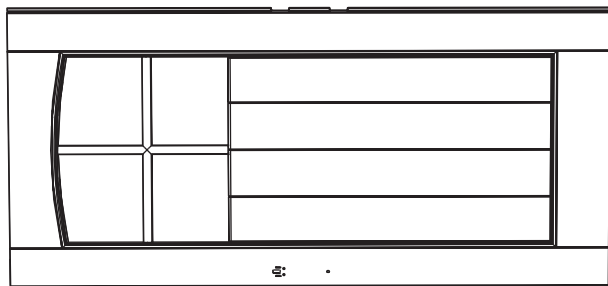

AGZ (x2)
Right & Center Doors

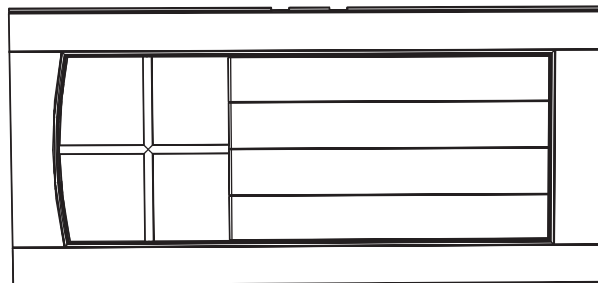

AGO (x1)
Left Door

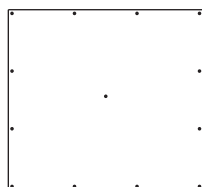

BLO (x3)
Door Window



TOOLS AND HARDWARE REQUIRED FOR THIS PAGE

SEC 1



Concrete (1 cu. yd.)



SEC

1.1

SITE PREPARATION - CONCRETE PLATFORM PREPARATION

The actual dimensions of your shed (at its widest and longest points) are 11' x 11'. Be sure to select a site that will accommodate these measurements. The base of the shed is slightly smaller than this, so you will need to create a level surface that is 123 1/2" x 123 1/2". The floor of the shed will have a slight overhang to help prevent water from pooling under the floor. We recommend using a level concrete or patio style surface. This will provide the best long-term performance for your shed.



Note: Shed Extension Kits are available for this shed. Please consider possible shed expansion when planning the site for your shed. See inside the back cover of this manual for information on ordering Extension Kits.

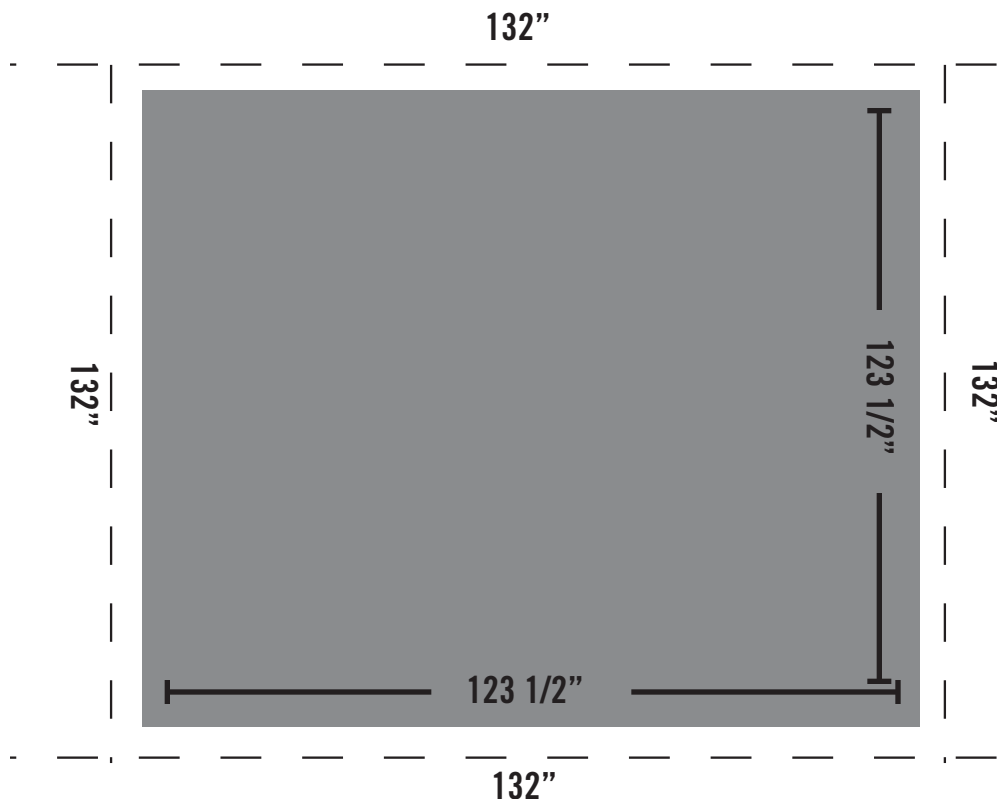

Note: Surface must be leveled before installation. If the surface is not properly leveled, the Outdoor Shed will not assemble or function correctly. Proper surface leveling will save you time in the long run, so please do not ignore this step.



TOOLS AND HARDWARE REQUIRED FOR THIS PAGE

SEC 1



2" x 4" x 123 1/2" (x2)

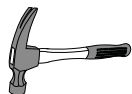

2" x 4" x 120 1/2" (x9)

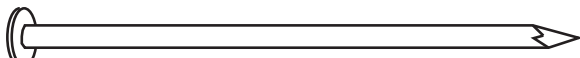

16d 3" Common Nail (x36)

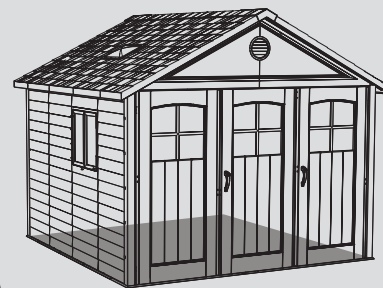

SEC

ALTERNATIVE SITE PREPARATION: OPTION 1 - WOOD PLATFORM ASSEMBLY

1.2

Ensure you use lumber that is treated and approved for **outdoor** use. Build outside frame to 123 1/2" by 123 1/2" outside dimensions.



Note: All lumber must be rated for outdoor use.

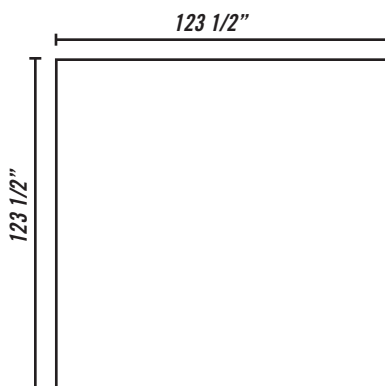

To ensure studs are in the correct location for nailing to plywood in the next step, start measuring here, and then measure from center to center.

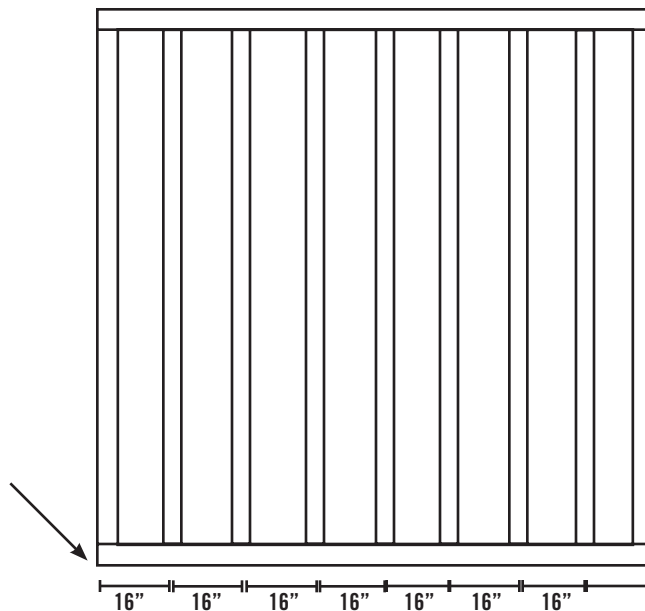

Note: Surface must be leveled before installation. If the surface is not properly leveled, the Outdoor Shed will not assemble or function correctly. Proper surface leveling will save you time in the long run, so please do not ignore this step.



TOOLS AND HARDWARE REQUIRED FOR THIS PAGE

SEC 1



48" x 96" x 3/4" Treated Plywood (x2)



27 1/2" x 96" x 3/4" Treated Plywood (x2)



27 1/2" x 27 1/2" x 3/4" Treated Plywood (x1)

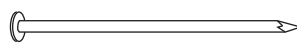

8d 1 1/2" Common Nail (x63)



SEC

1.3

ALTERNATIVE SITE PREPARATION: OPTION 1 - WOOD PLATFORM ASSEMBLY (CONT)

Square up the frame by measuring from corner to corner. Measurement A should equal Measurement B.



Note: All lumber must be rated for outdoor use.

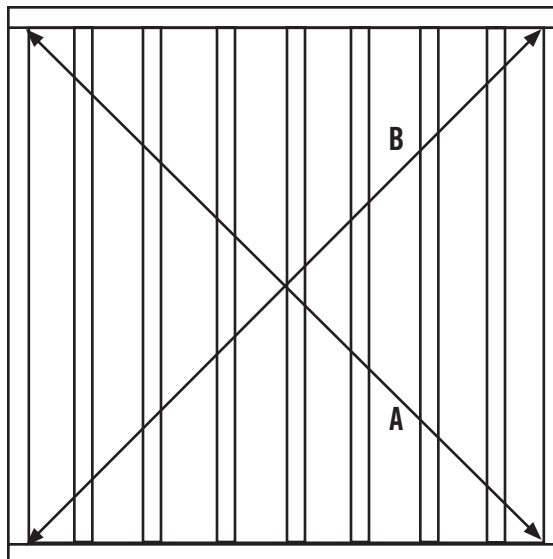

SEC

1.4

Cut Plywood into sizes called for on previous page. Arrange the Plywood according to the diagram and nail into place with 8d x 1 1/2" nails. Place platform in the desired location. If platform does not rest level on the ground, build up low points with loose dirt until platform is stable.

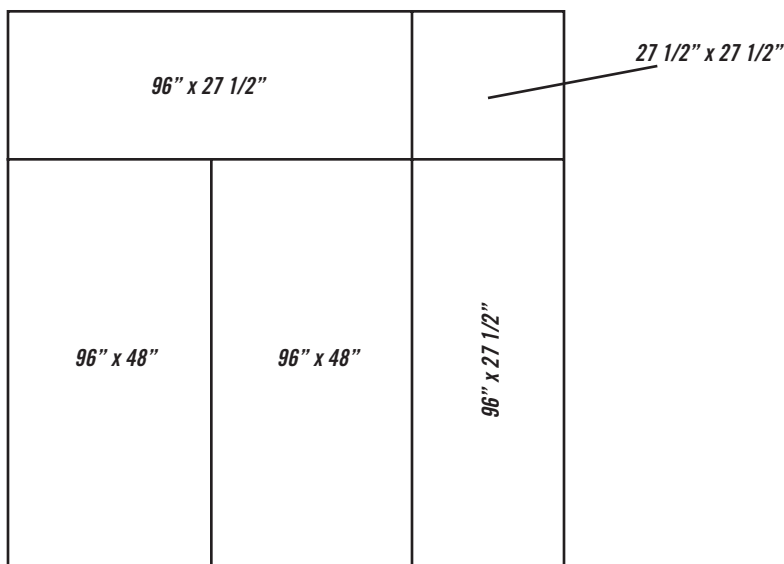



TOOLS AND HARDWARE REQUIRED FOR THIS PAGE

SEC 1

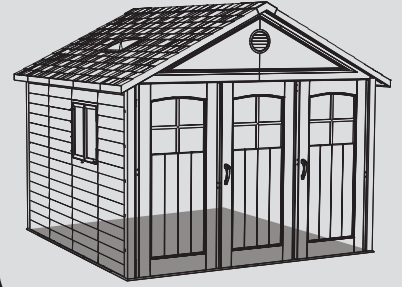
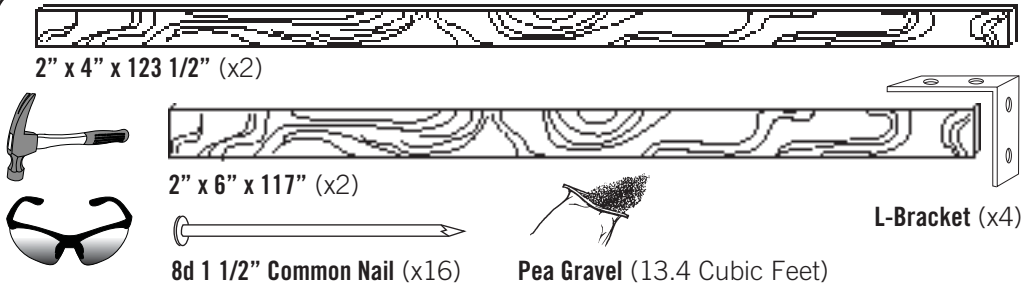

SEC 1.5

ALTERNATIVE SITE PREPARATION: OPTION 2 - FILLED WOOD FRAME ASSEMBLY

Cut outside frame to 123 1/2" by 123 1/2" outside dimensions. Lay boards flat so widest part faces up. Ensure frame is level. Square up the frame by measuring from corner to corner. Measurement A should equal Measurement B. Nail an L-Bracket on each corner of the frame with 8d nails. Place platform in the desired location. If platform does not rest level on the ground, build up low points with loose dirt or "Pea" gravel, until platform is stable.

! Note: Whenever possible you should use the surfaces described on Page 7.

! Note: All lumber must be rated for outdoor use.

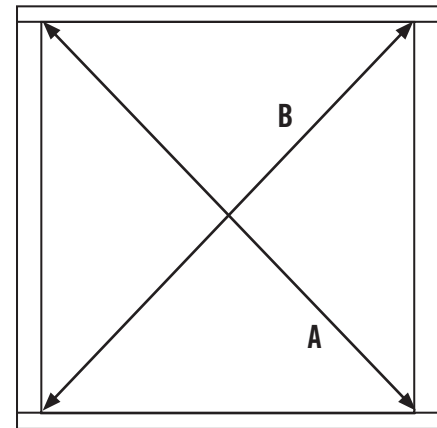
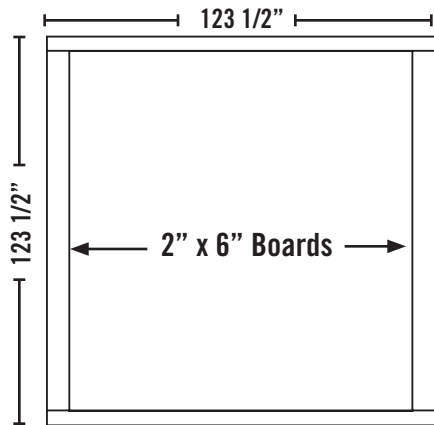

SEC 1.6

Once all boards are level and do not wobble, pack "Pea" gravel around the outside of the frame, and slope away from frame.

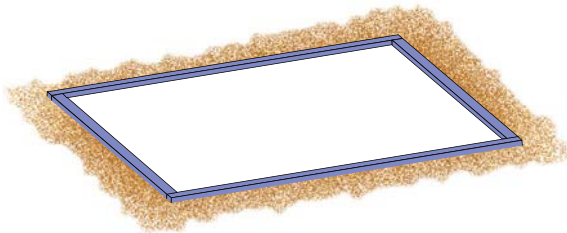

SEC 1.7

Now fill the inside of the frame with "Pea" gravel. Use a leveling board to scrape off extra fill material and to level the surface.

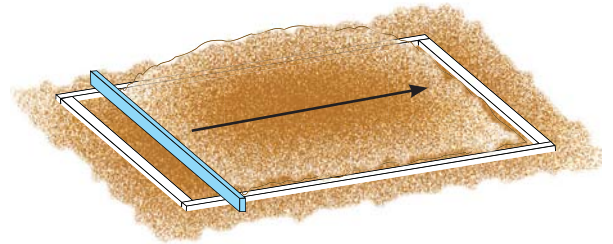

SEC 2 FLOOR ASSEMBLY

PLASTIC PARTS REQUIRED

LOCATED IN BOXES: 1, 2, 3

Parts shown at 4% of actual size

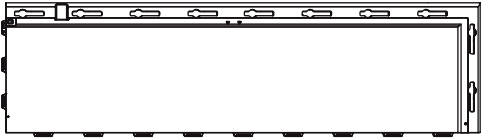

AGS (x2)
Outer Floor Panel A



AGJ (x6)
Inner Floor Panel

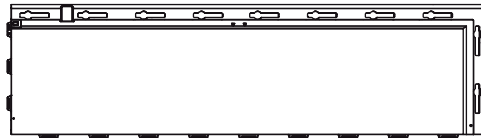

AGT (x2)
Outer Floor Panel B

TOOLS REQUIRED



Safety Glasses



TOOLS AND HARDWARE REQUIRED FOR THIS PAGE



NO HARDWARE REQUIRED FOR THIS PAGE

SEC 2



SEC

2.1

FLOOR PANEL ASSEMBLY

Hold one (1) **Outer Floor Panel "B" (AGT)** at an angle against one (1) **Outer Floor Panel "A" (AGS)** so the tabs on Panel "B" fit underneath Panel "A", and the tabs on Panel A fit underneath Panel "B". Then, lay Panel "B" flat.

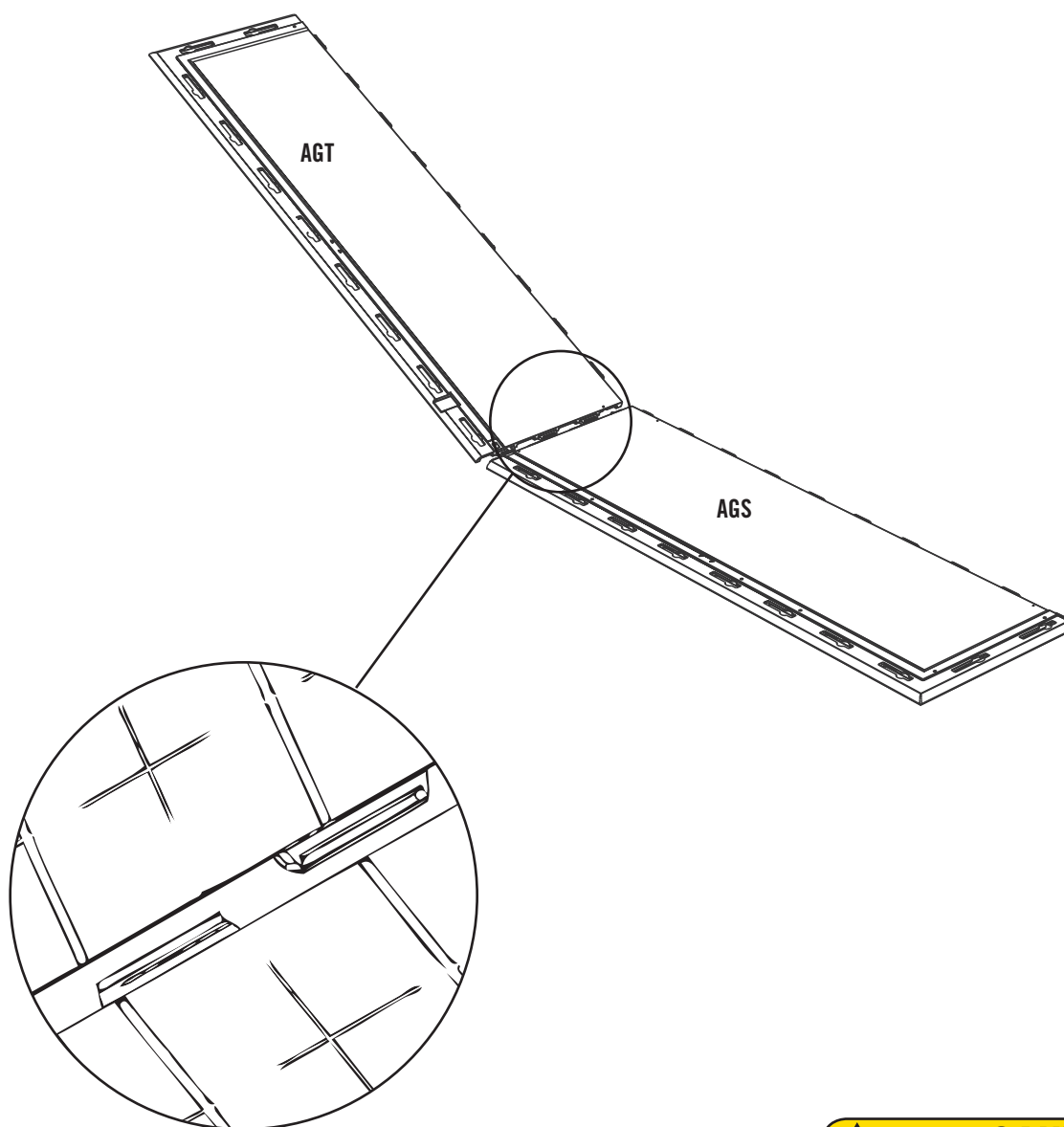

CAUTION

Sharp objects may damage your floor. If resting sharp, heavy objects on your shed floor, place a block of wood between the sharp object and floor.



TOOLS AND HARDWARE REQUIRED FOR THIS PAGE



NO HARDWARE REQUIRED FOR THIS PAGE

SEC 2



SEC

2.2

Hold an **Inner Floor Panel (AGJ)** at an angle against another Inner Floor Panel so the tabs on each Panel fit underneath the other Panel. Then, lay the Panel flat. Connect the Inner Floor Panels to the Outer Floor Panels using the same procedure.

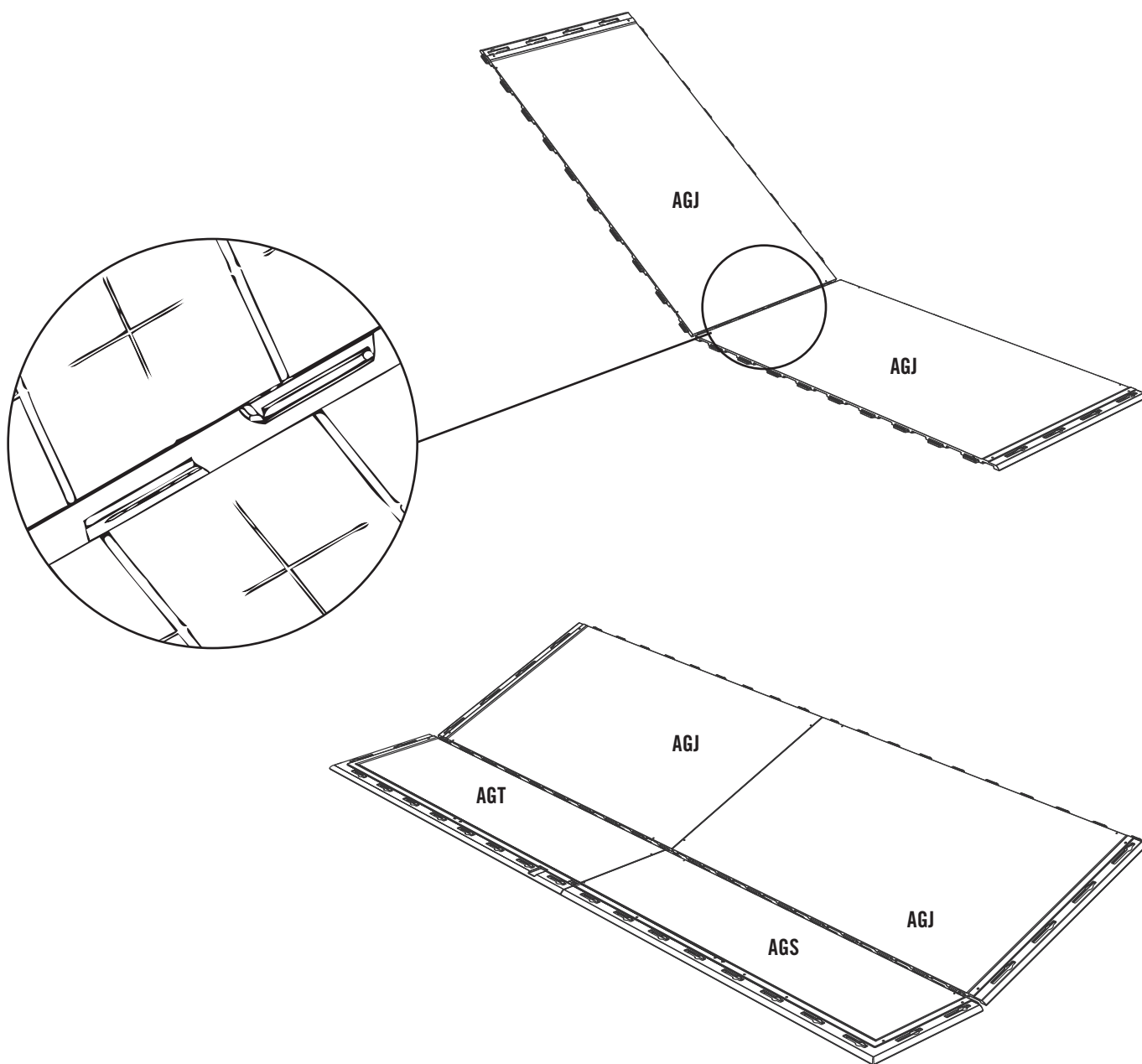



TOOLS AND HARDWARE REQUIRED FOR THIS PAGE



NO HARDWARE REQUIRED FOR THIS PAGE

SEC 2

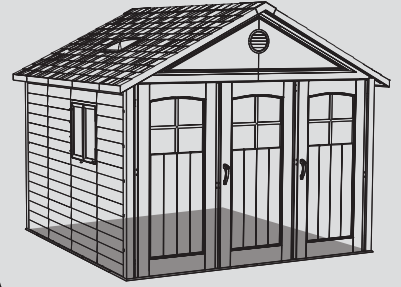

SEC

2.3

Repeat the previous step to connect all the **Inner Floor Panels (AGJ)** to each other. Finally, connect the last two **Outer Floor Panels (AGS & AGT)** to the Inner Floor Panels.

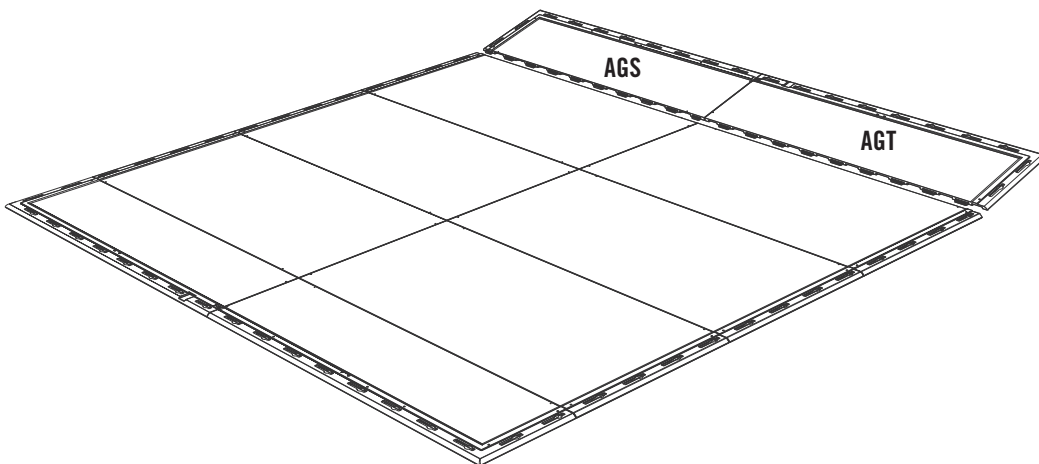
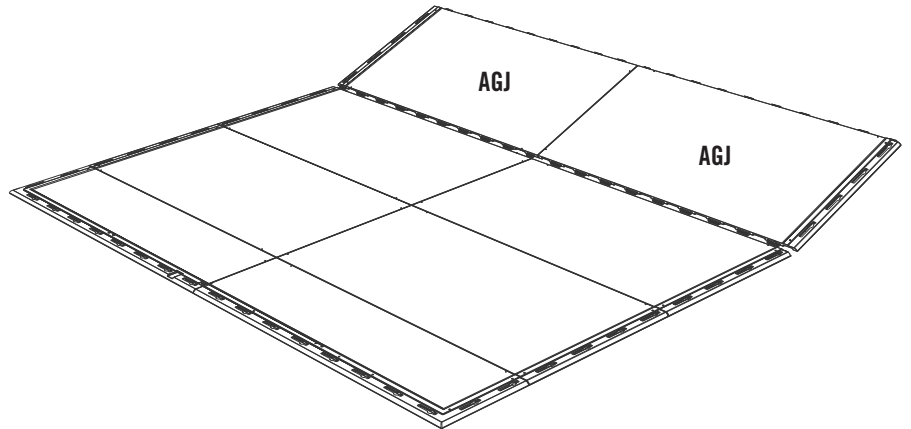
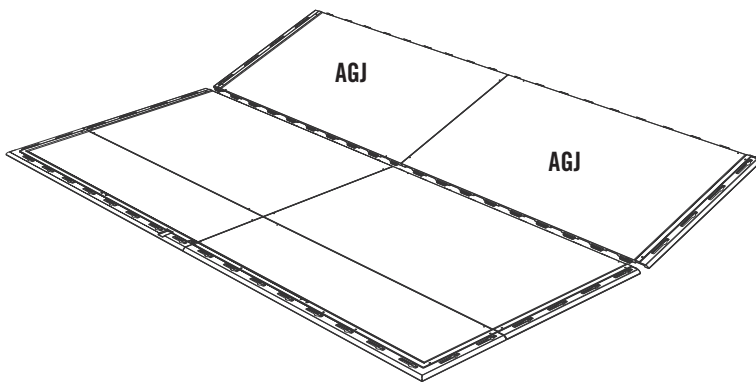

SEC 3 TRUSS & WALL CHANNEL ASSEMBLY

HARDWARE REQUIRED

Hardware shown at actual size

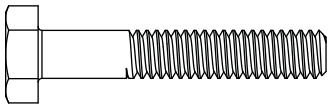

AAK (x40)
1/4" x 1 1/2" Hex Bolt



ADJ (x40)
1/4" Cap Nut

HARDWARE BOX REQUIRED: BGV (x4)

Hardware shown at 50% of actual size

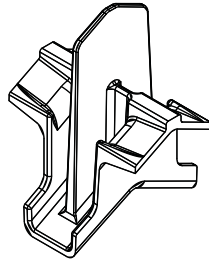

AIP (x4)
Truss Gutter Connector



AHT (x8)
Floor Bracket

METAL PARTS REQUIRED

Parts shown at 8% of actual size



AFH (x8)
Truss Gutter Channel

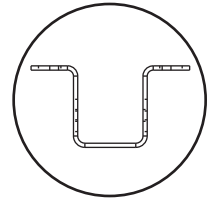

AFG (x4)
Truss Brace Channel

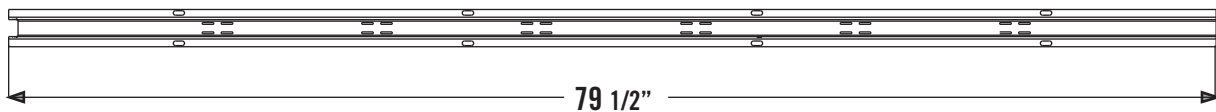
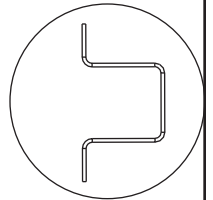

AFQ (x8)
Wall Support Channel

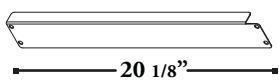
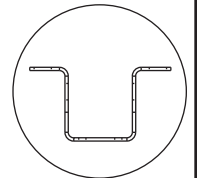

AFP (x8)
Truss Support Strip

TOOLS REQUIRED



7/16" Wrench (x2)



Safety Glasses



TOOLS AND HARDWARE REQUIRED FOR THIS PAGE

SEC 3



7/16" (x2)

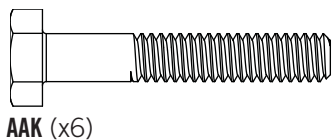

AAK (x6)



ADJ (x6)

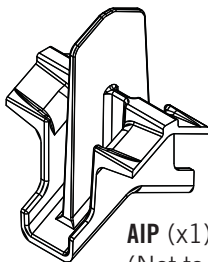

AIP (x1)
(Not to scale)

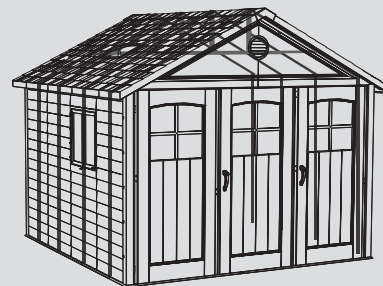

SEC

3.1

TRUSS ASSEMBLY

Fit two **Truss Support Strips (AFP)** together. Bolt Truss Support Strips, **Truss Gutter Connector (AIP)**, and two **Truss Gutter Channels (AFH)** as shown using the required hardware.

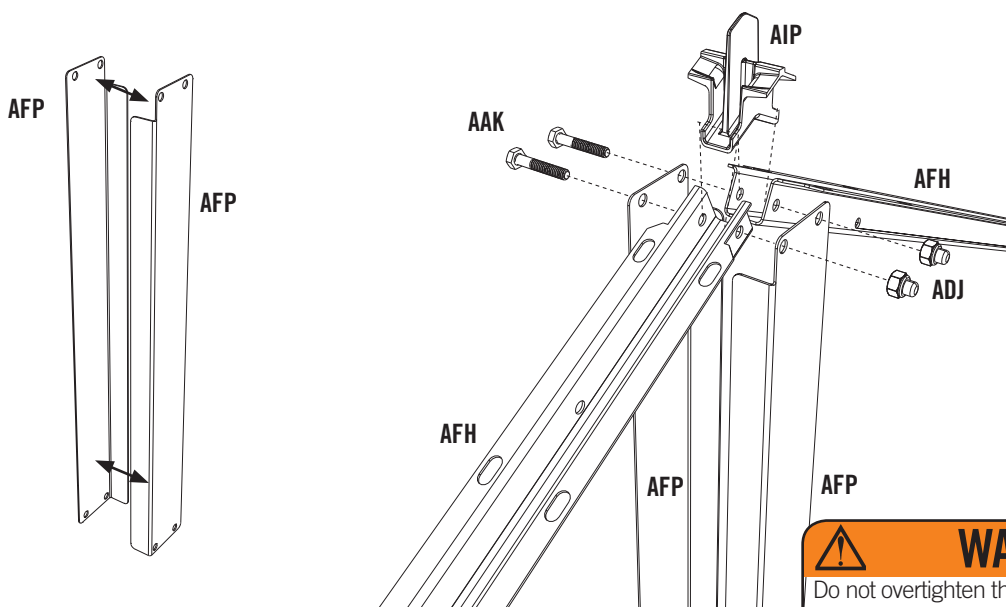

Note: Only finger tighten hardware.



WARNING

Do not overtighten the Cap Nut. If the end of the Bolt breaks through the plastic cap, call our Customer Service Department. Exposed threads on the end of the Bolt may cause serious injuries.

SEC

3.2

Attach **Truss Support Strips (AFP)** to the center of a **Truss Brace Channel (AFG)** (Truss Support Strips fit inside the Truss Brace Channel). Attach each end of the Truss Brace Channel to the **Truss Gutter Channels (AFH)** using the required hardware. Tighten all hardware.

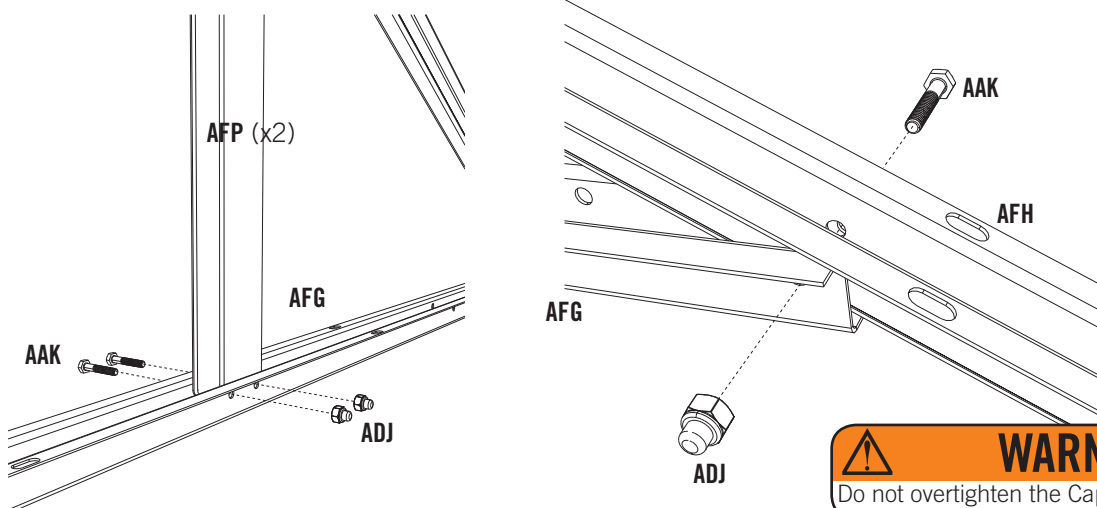

WARNING

Do not overtighten the Cap Nut.



TOOLS AND HARDWARE REQUIRED FOR THIS PAGE

SEC 3



7/16" (x2)

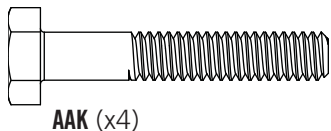

AAK (x4)



AHT (x2)
(Not to scale)



ADJ (x4)

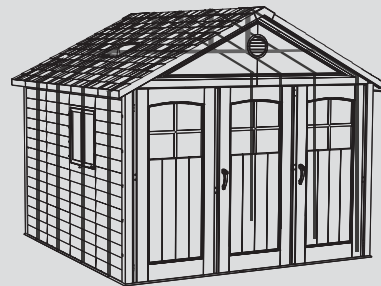

SEC

3.3

Attach Truss Assembly to two **Wall Support Channels (AFQ)** using **1/4" x 1 1/2" Hex Bolts (AAK)** and **1/4" Cap Nuts (ADJ)**. Do not completely tighten the Cap Nut until after Truss is secured to the Wall.

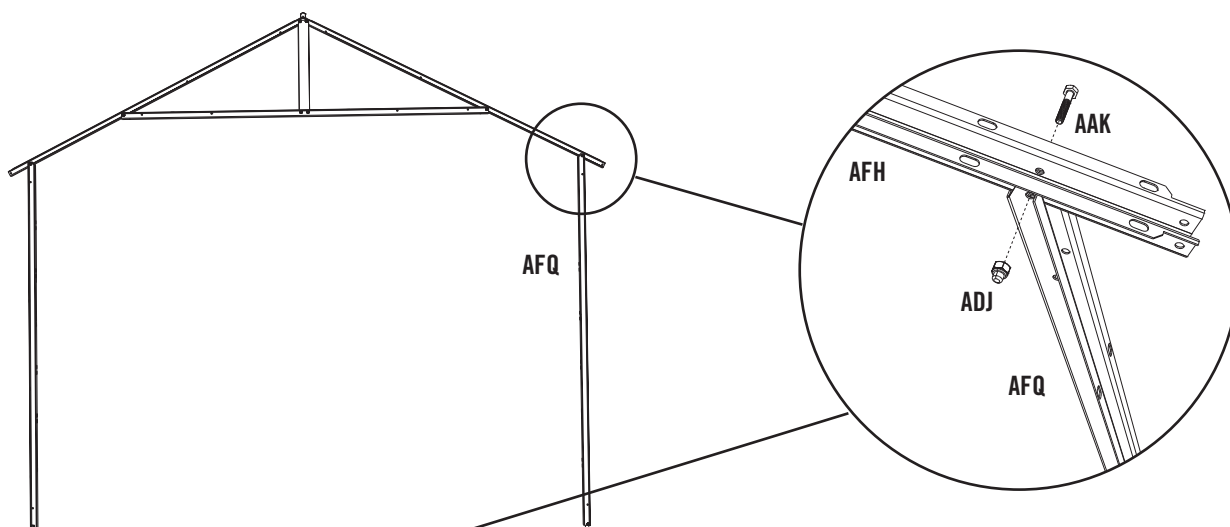

WARNING

Do not overtighten the Cap Nut.



Note: Only finger tighten hardware.

SEC

3.4

Attach one **Floor Bracket (AHT)** to the bottom of each Wall Support Channel and to the Floor. Tighten all hardware. You need only do this step if you plan to anchor your Shed. See the "Anchoring the Shed" step at the end of your Owner's Manual.

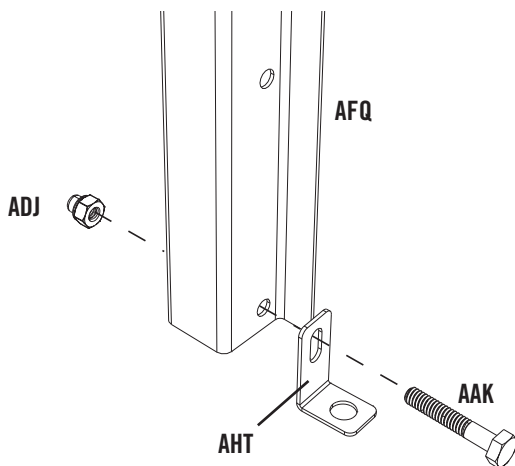

WARNING

Do not overtighten the Cap Nut.

REPEAT THIS SECTION FOR REMAINING TRUSSES

SEC 4 WALL PANEL INSTALLATION

HARDWARE REQUIRED

HARDWARE BAG REQUIRED: BMX

Hardware shown at actual size

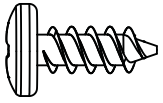

ADZ (x78)
1/4" x 5/8" Pan-Head Screw



ADC (x1)
#2 Phillips Bit

METAL PARTS REQUIRED

METAL PARTS KIT REQUIRED: BNN

Part shown at 8% of actual size

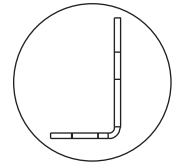
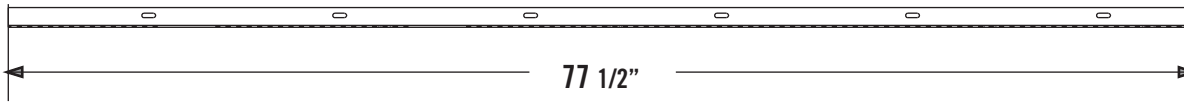

AFR (x2)
Corner Channel

PLASTIC PARTS REQUIRED

LOCATED IN BOXES: 2, 3, 4

Part shown at 4% of actual size

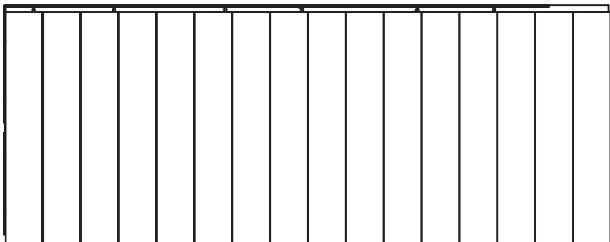

AHD (x10)
Wall Panel

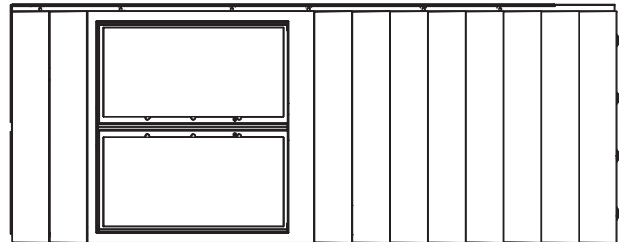

AHH (x2)
Window Wall Panel

TOOLS REQUIRED

HARDWARE BAG REQUIRED: BMX



Phillips Screwdriver



ADC (x1)
#2 Phillips Bit (Included)



Safety Glasses



TOOLS AND HARDWARE REQUIRED FOR THIS PAGE

SEC 4

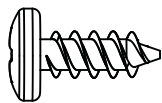

ADZ (x18)



SEC

WALL ASSEMBLY

4.1

Lock a **Wall Panel (AHD)** into the right front corner position by inserting the tabs at the bottom of the Wall Panel into the slots on the Shed Floor. After inserting the tabs, slide the Wall Panel to the right to lock it in place. Install a **Window Wall Panel (AHH)** and secure with six (6) **1/4" x 5/8" Phillips Pan-Head Screws (ADZ)**.

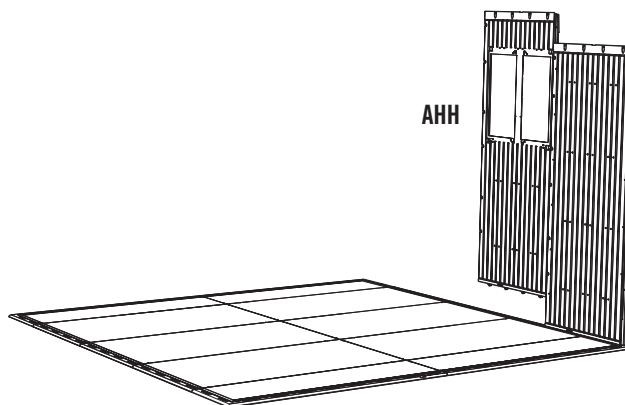
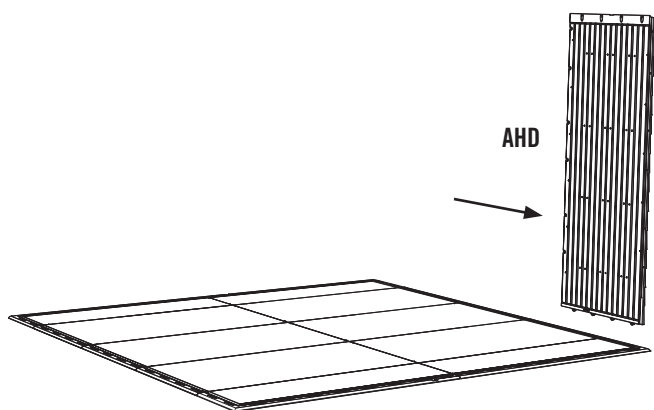

SEC

4.2

Install two more **Wall Panels (AHD)** and secure with twelve (12) **1/4" x 5/8" Phillips Pan-Head Screws (ADZ)**.

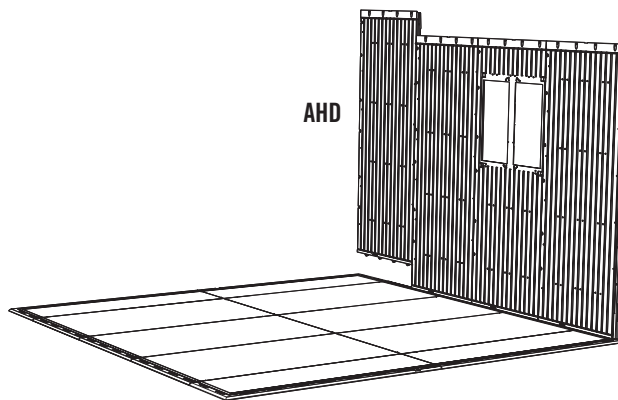
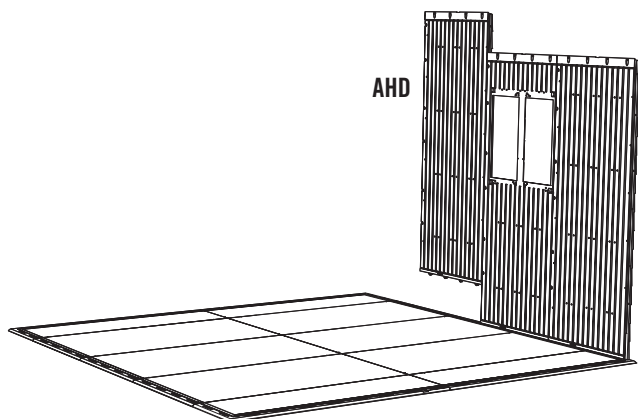

Note: A second adult should apply pressure to the opposite side of the wall for easy insertion of screws.



TOOLS AND HARDWARE REQUIRED FOR THIS PAGE

SEC 4

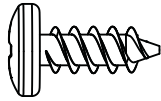

ADZ (x12)

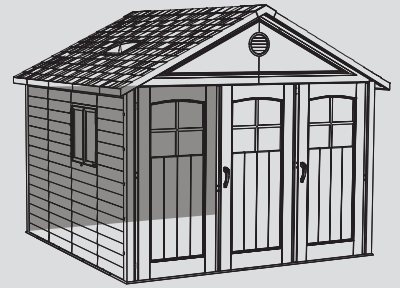

SEC

4.3

Install next **Wall Panel (AHD)** at the right, rear corner of the Shed.

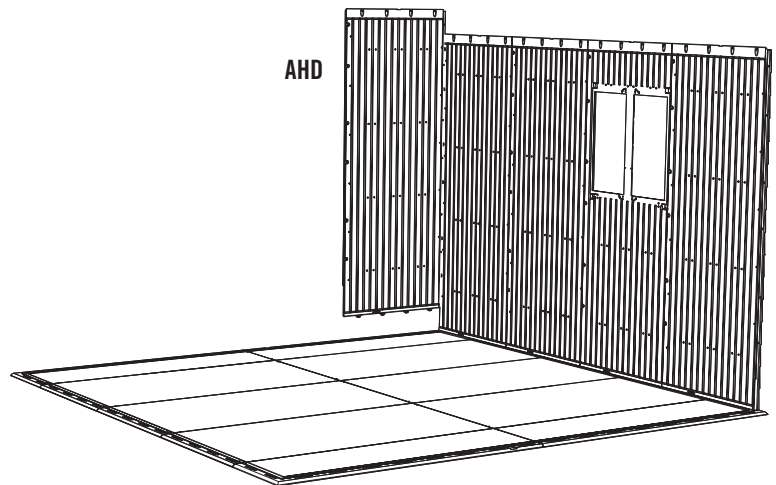

SEC

4.4

Align the holes in a **Corner Channel (AFR)** with the holes in two corner Wall Panels and secure the Corner Channel to the Wall Panels with twelve (12) **1/4" x 5/8" Phillips Pan-Head Screws (ADZ)**.

AFR (x1)

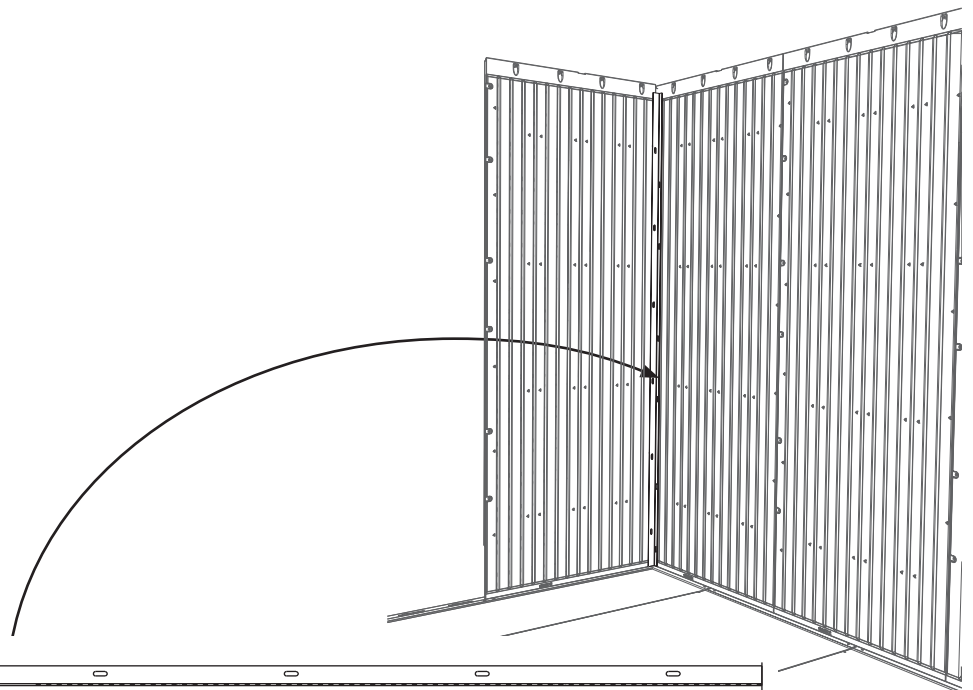

77 1/2"



TOOLS AND HARDWARE REQUIRED FOR THIS PAGE

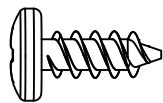

ADZ (x18)

SEC

4

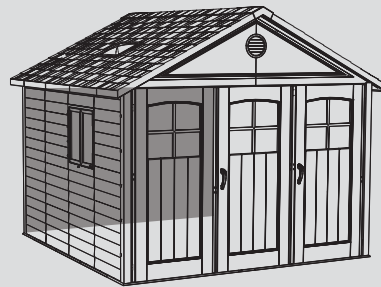

SEC

4.5

Assemble next three **Wall Panels (AHD)**. Secure the Wall Panels together with eighteen (18) 1/4" x 5/8" Phillips Pan-Head Screws (ADZ).

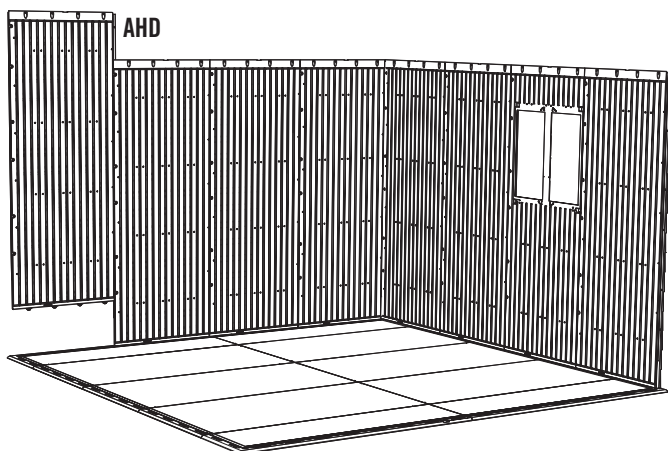
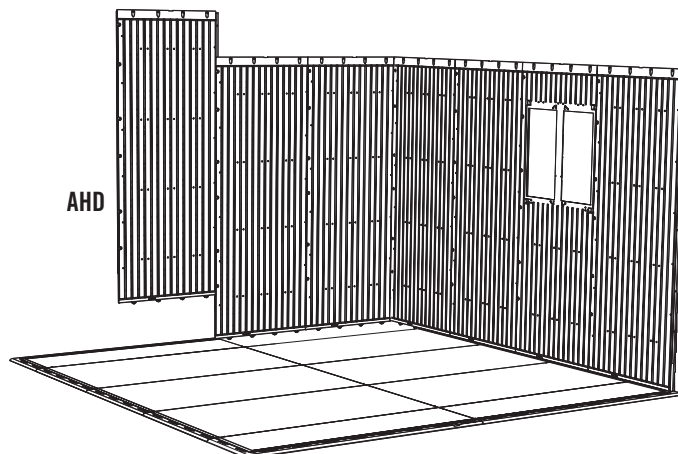
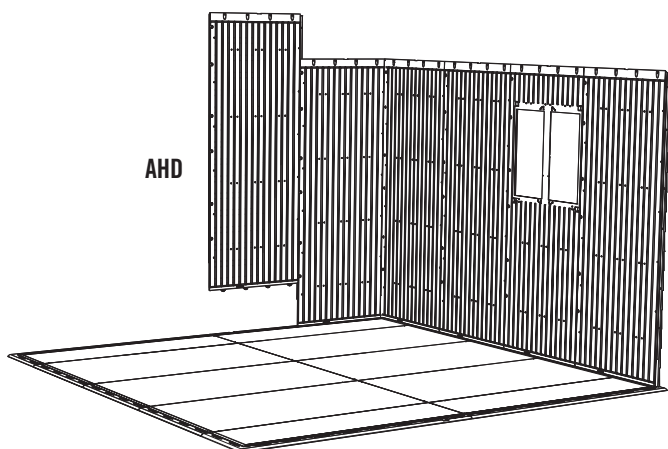

! Note: A second adult should apply pressure to the opposite side of the wall for easy insertion of screws.



TOOLS AND HARDWARE REQUIRED FOR THIS PAGE

SEC 4

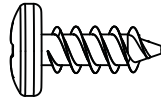

ADZ (x30)

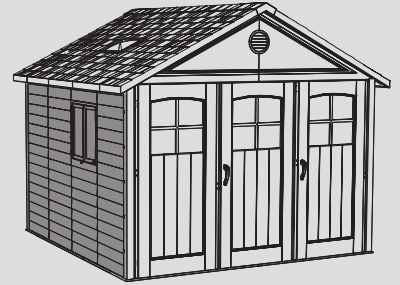

SEC

4.6

Install the next Wall Panel at the left, rear corner of the Shed and connect the two rear, corner **Wall Panels (AHD)** with a Corner Channel and twelve (12) 1/4" x 5/8" Phillips Pan-Head Screws (ADZ). Connect the next Wall Panel using six (6) 1/4" x 5/8" Phillips Pan-Head Screws (ADZ).

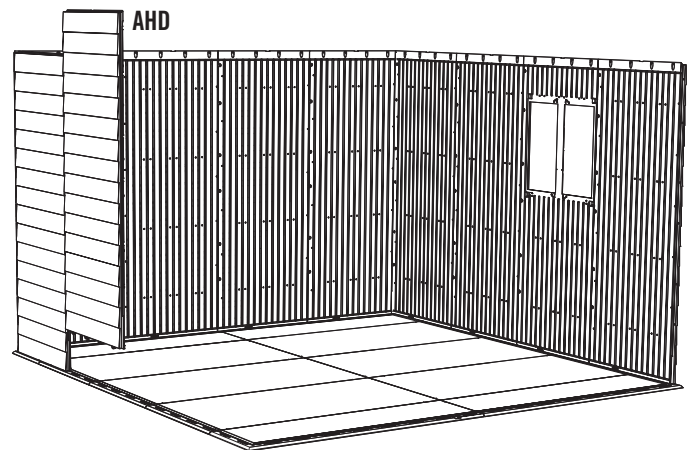
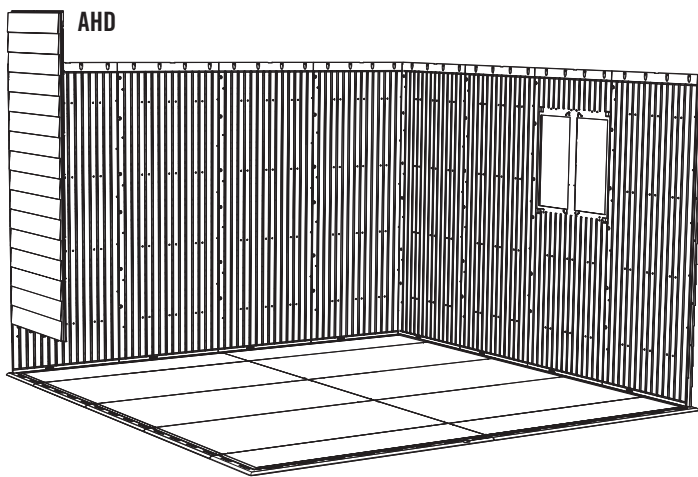

SEC

4.7

Finally, install the last **Window Wall Panel (AHH)** and **Wall Panel (AHD)** to the Shed using twelve (12) 1/4" x 5/8" Phillips Pan-Head Screws (ADZ).

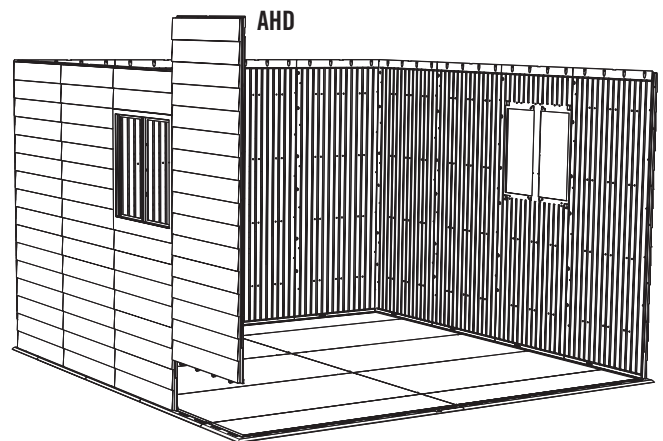
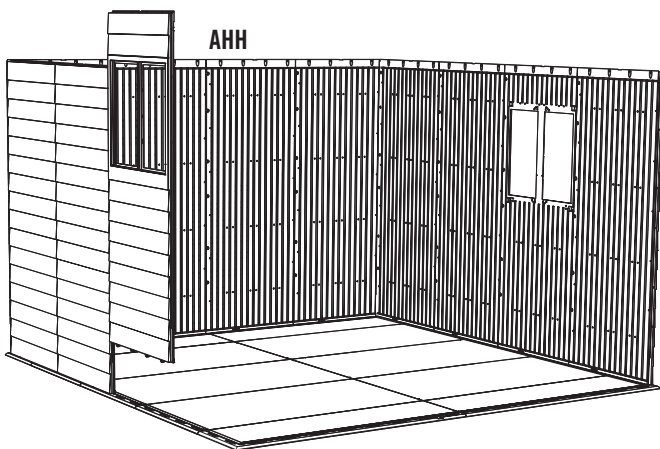

Note: A second adult should apply pressure to the opposite side of the wall for easy insertion of screws.

SEC 5 TRUSS FRAME & WALL SUPPORT INSTALLATION

HARDWARE REQUIRED

Hardware shown at actual size (*Unless otherwise noted)

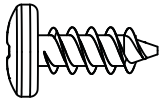

ADZ (x96)
1/4" x 5/8" Pan-Head Screw

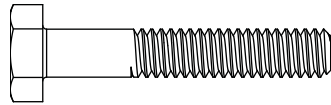

AAK (x18)
1/4" x 1 1/2" Hex Bolt
(Not all are used)



ADJ (x18)
1/4" Cap Nut
(Not all are used)



AHT (x6)*
Floor Bracket
(Not used)



ADK (x4)
#10 Cap Nut

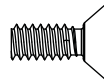

ACD (x4)
#10 x 3/8" Flat-Head Screw

METAL PARTS REQUIRED

Parts shown at 8% of actual size

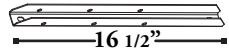

AFN (x2)
Short Vertical Extension Channel

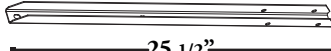

AFJ (x2)
Long Vertical Extension Channel



AFQ (x4)
Wall Support Channel

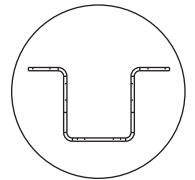

HARDWARE BAG REQUIRED: BNI

METAL PARTS KIT REQUIRED: BNN, BNK, BNF

TOOLS REQUIRED



7/16" Wrench (x2)

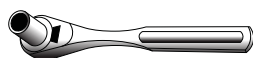

7/16" Socket Wrench



Phillips Screwdriver



Safety Glasses



TOOLS AND HARDWARE REQUIRED FOR THIS PAGE

SEC 5



3/8" (x2)

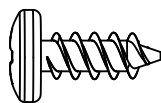

ADZ (x64)



ADK (x4)

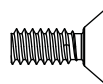

ACD (x4)

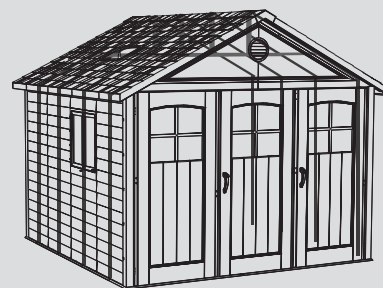

SEC

TRUSS INSTALLATION

5.1

Starting at the back of the Shed, secure a Truss Frame Assembly to the center of each Left and Right Wall Panel with the 1/4" x 5/8" Pan-Head Screws (ADZ). **DO NOT** use the 1/4" x 5/8" Pan-Head Screws (ADZ) to secure the Truss Frame Assembly to the center divider in the Window Wall Panel.

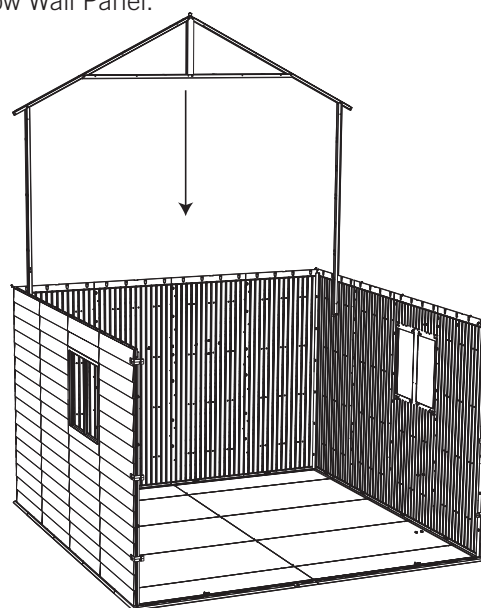

SEC

5.2

Secure the Truss Frame Assembly to the center divider in the Window Wall Panel with two (2) #10 x 3/8" Flat-Head Screws (ACD) through the holes in the center of the Window Wall Panels, and secure the Truss Frame Assembly to the center divider with two (2) #10 Cap Nuts (ADK). Repeat this step for second Window Wall Panel.

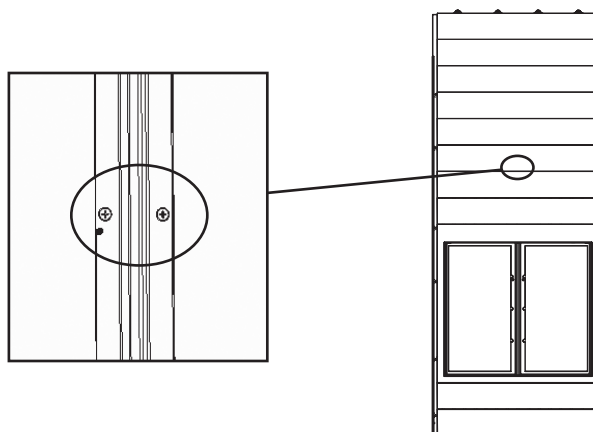

Note: After installing Truss Assembly, tighten nuts completely.



WARNING

Do not overtighten the Cap Nut. If the end of the Bolt breaks through the plastic cap, call our Customer Service Department. Exposed threads on the end of the Bolt may cause serious injuries.



TOOLS AND HARDWARE REQUIRED FOR THIS PAGE

SEC 5



7/16" (x2)

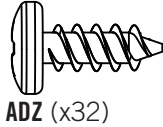

ADZ (x32)



ADJ (x8)

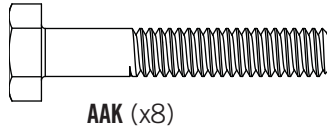

AAK (x8)

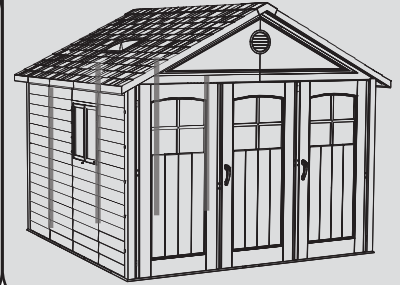

SEC

5.3

REAR GABLE SUPPORT INSTALLATION

Attach a **Long Vertical Extension Channel (AFJ)** to a **Wall Support Channel (AFQ)**. Repeat.



AFJ

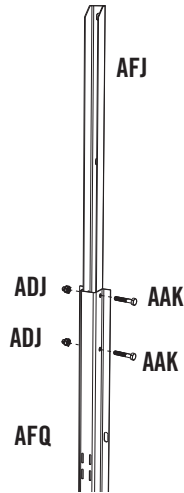

AFJ

ADJ AAK

ADJ AAK

AFQ

SEC

5.4

Attach a **Short Vertical Extension Channel (AFN)** to a **Wall Support Channel**. Ensure Extension Channel is installed in the correct direction. Repeat.

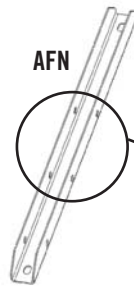

AFN

Use these holes to Attach the Wall Support Channel

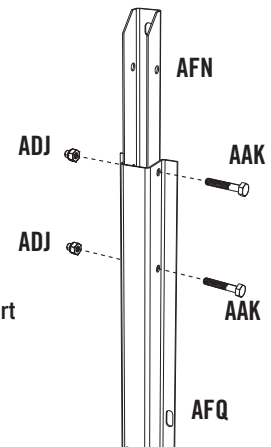

AFN

ADJ

AAK

ADJ

AAK

AFQ

SEC

5.5

Secure Wall Supports to rear Wall using thirty-two (32) **1/4" x 5/8" Phillips Pan-Head Screws (ADZ)**. Position the shorter Supports with Channels at the far left and far right Wall Panels. The long Supports are placed in the middle positions. Do not completely tighten the Screws until after the rear Gable is installed.

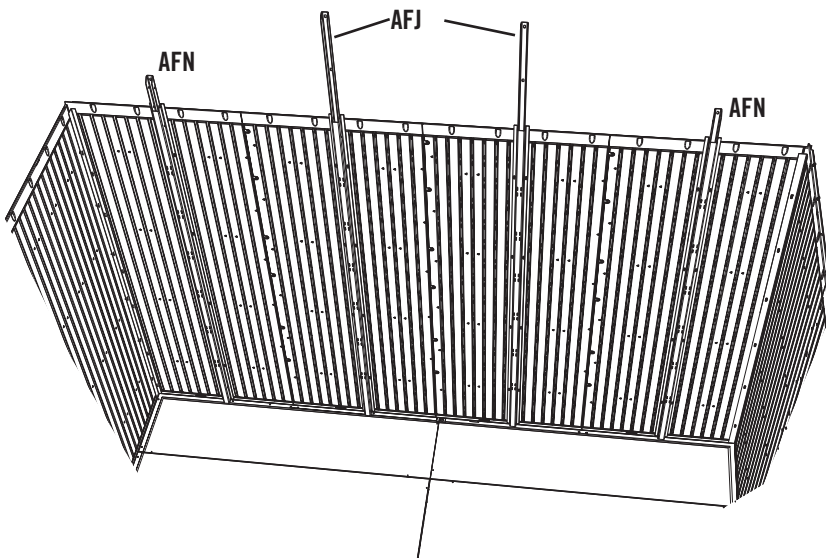

AFN

AFJ

AFN



WARNING

Do not overtighten the Cap Nut.

Note: A second adult should apply pressure to the opposite side of the wall for easy insertion of screws.

SEC 6 GABLE ASSEMBLY

HARDWARE REQUIRED

HARDWARE BAG REQUIRED: BNA (x2)

Hardware shown at actual size

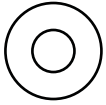

AEE (x10)
#10 x 1/2" Flat Washer

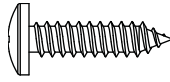

ADW (x10)
#10 x 3/4" Pan-Head Screw

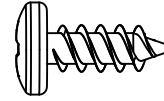

ADZ (x8)
1/4" x 5/8" Pan-Head Screw

Parts shown at 15% of actual size

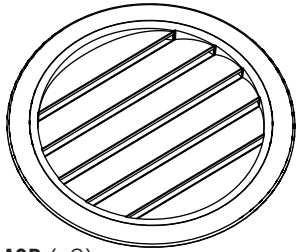

AGP (x2)
Louvered Vent

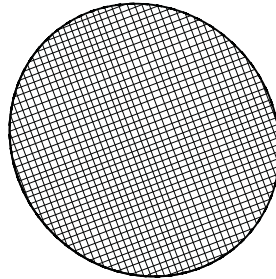

AIQ (x2)
Vent Screen

PLASTIC PARTS REQUIRED

LOCATED IN BOX: 1

Parts shown at 4% of actual size

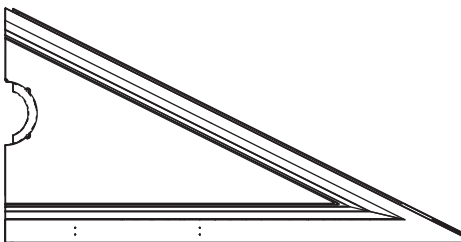

AGH (x2)
Gable Half 1

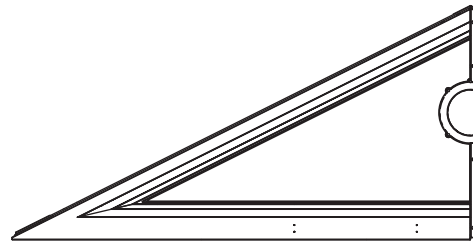

AGI (x2)
Gable Half 2

TOOLS REQUIRED

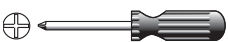

Phillips Screwdriver



Safety Glasses



TOOLS AND HARDWARE REQUIRED FOR THIS PAGE

SEC 6

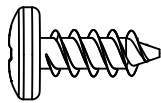

ADZ (x8)



SEC

GABLE ASSEMBLY

6.1

Set the edge of **Gable Half 2 (AGI)** over the edge of **Gable Half 1 (AGH)** as shown.

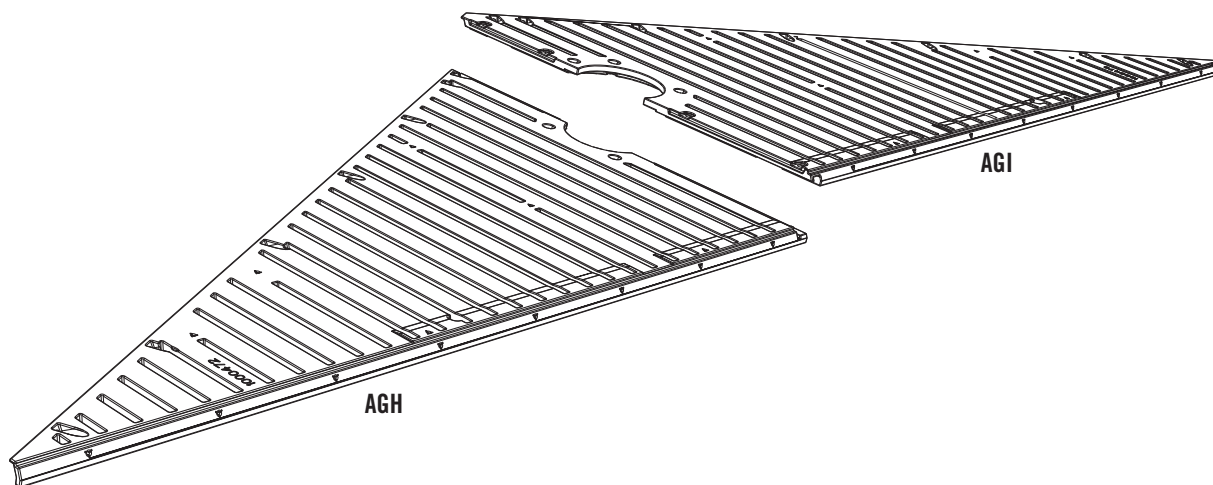

SEC

6.2

Secure the two Gable Halves together using four (4) 1/4" x 5/8" Pan-Head Screws (ADZ).

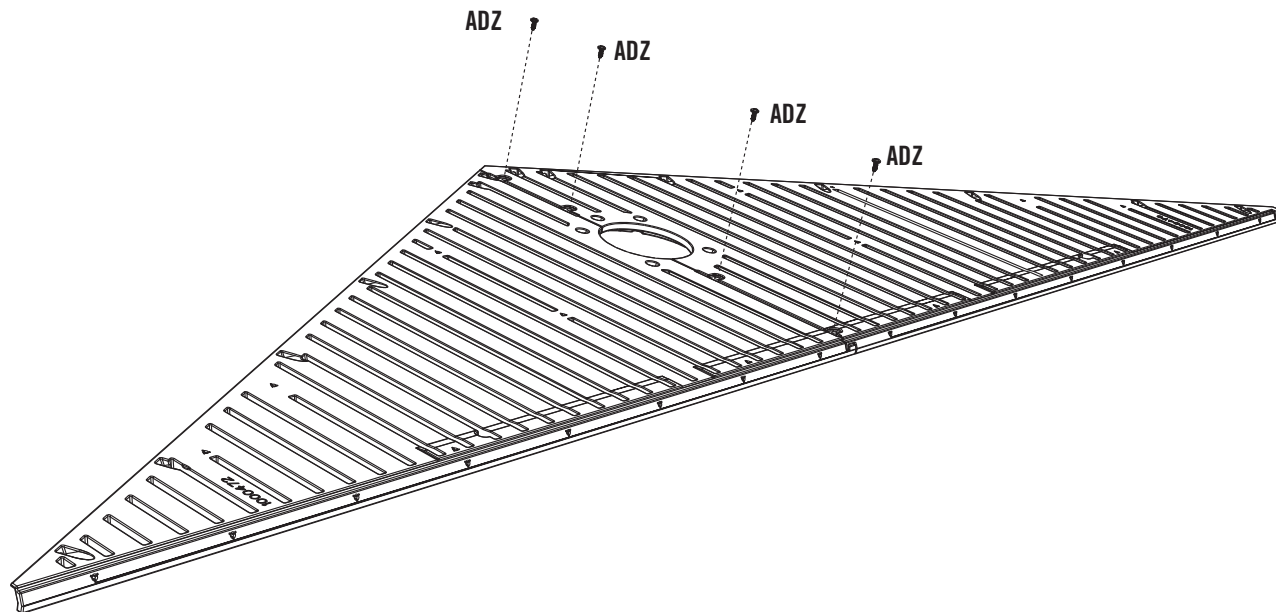



TOOLS AND HARDWARE REQUIRED FOR THIS PAGE

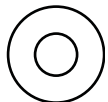

AEE (x10)

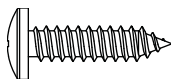

ADW (x10)

SEC 6



SEC

6.3

Attach the **Louvered Vent (AGP)** and **Vent Screen (AIQ)** to the Gable Assembly using five (5) **#10 x 1/2" Flat Washers (AEE)** and five (5) **#10 x 3/4" Phillips Pan-Head Screws (ADW)**. Set the Gable Assembly aside until later. Repeat this section for the second Gable.

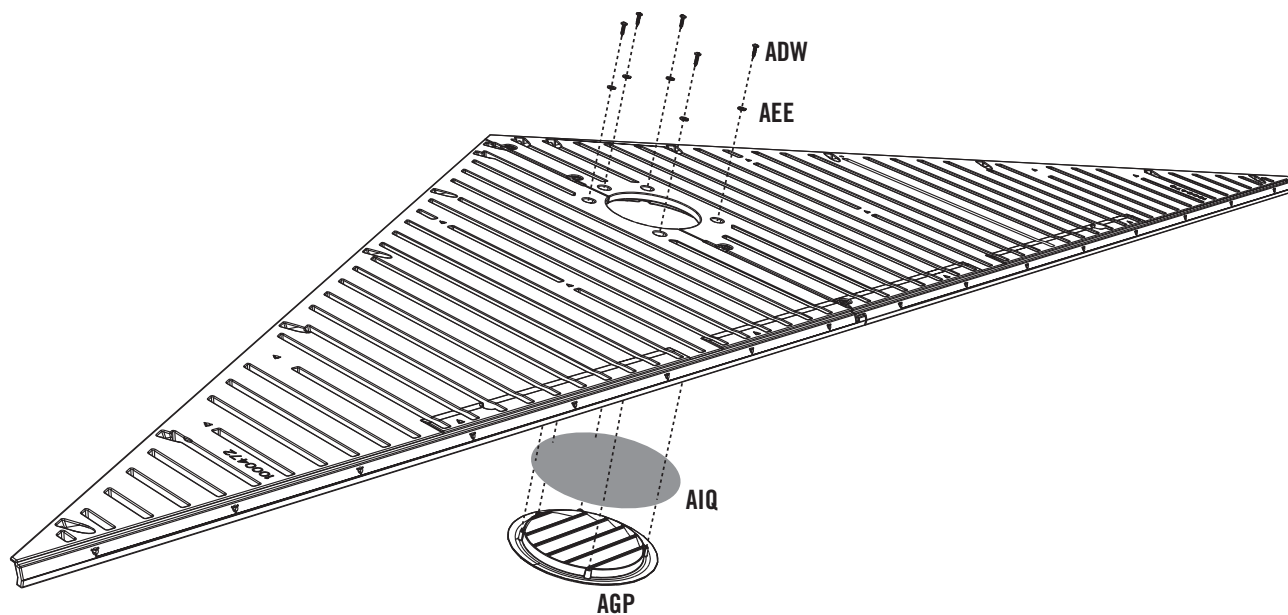

SEC 7 LEFT DOOR ASSEMBLY

HARDWARE REQUIRED

Hardware shown at actual size

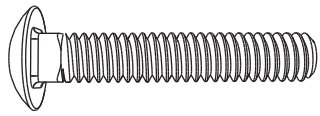

ABU (x2)
1/4" x 1 1/2" Carriage Bolt



ADJ (x2)
1/4" Cap Nut

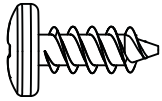

ADZ (x9)
1/4" x 5/8" Pan-Head Screw

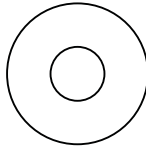

AEB (x2)
1/4" Flat Washer

HARDWARE BAG REQUIRED: BMW

Hardware shown at 25% of actual size

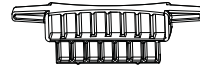

AHM (x2)
Dead Bolt Latch

METAL PARTS REQUIRED

LOCATED IN BOX 1 AND METAL PARTS KIT: BNM

Part shown at 8% of actual size

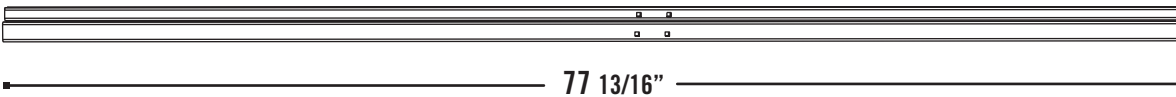

BKZ (x1)
Center Hinge Assembly

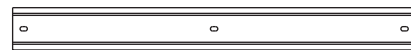

AFB (x3)
Door Brace

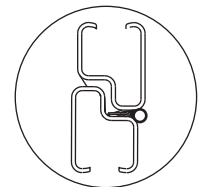

PLASTIC PARTS REQUIRED

LOCATED IN BOX: 5

Part shown at 4% of actual size

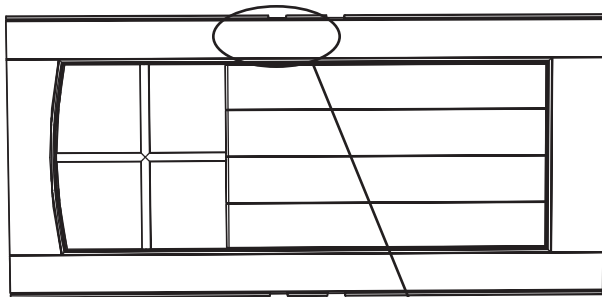

AGO (x1)
Left Door

! Note: The Left Door is slightly different from the other two; there are no holes for a handle.

TOOLS REQUIRED



Phillips Screwdriver



7/16" Wrench



Safety Glasses



TOOLS AND HARDWARE REQUIRED FOR THIS PAGE

SEC 7

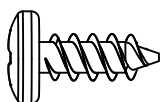

ADZ (x9)



AHM (x1)
(Not to scale)



SEC

LEFT DOOR ASSEMBLY

7.1

Secure three (3) **Door Braces (AFB)** to the inside of the **Left Door (AGO)** using the required hardware.

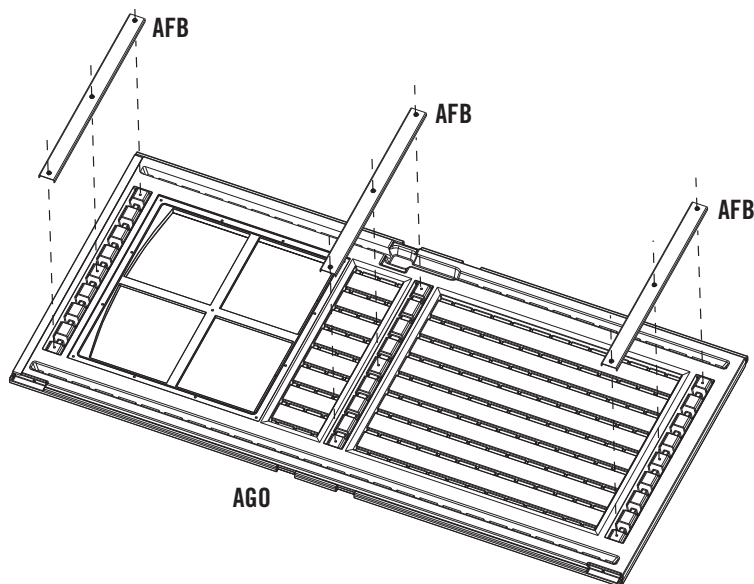

SEC

7.2

Place a **Dead Bolt Latch (AHM)** in the notch at the top of the door as shown. Orient a **Center Hinge Assembly (BKZ)** as shown, and slide the Center Hinge Assembly down over the bottom lip of the Dead Bolt Latch and the end of the Left Door.

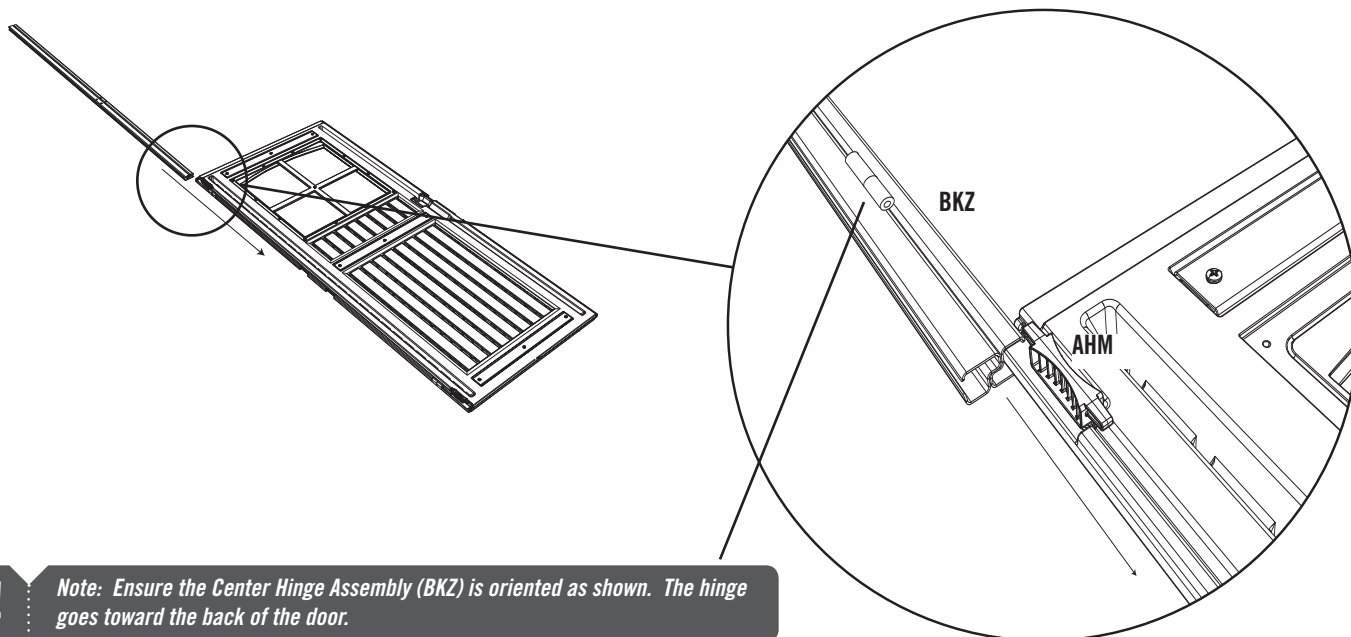

Note: Ensure the Center Hinge Assembly (BKZ) is oriented as shown. The hinge goes toward the back of the door.



TOOLS AND HARDWARE REQUIRED FOR THIS PAGE

SEC 7



7/16"

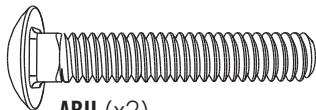

ABU (x2)



ADJ (x2)

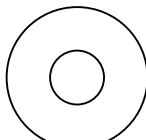

AEB (x2)

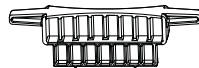

AHM (x1)
(Not to scale)



SEC

7.3

Place a second **Dead Bolt Latch (AHM)** in the notch at the bottom of the Left Door, and continue sliding the **Center Hinge Assembly (BKZ)** over the Left Door and over bottom lip of the second Dead Bolt Latch.

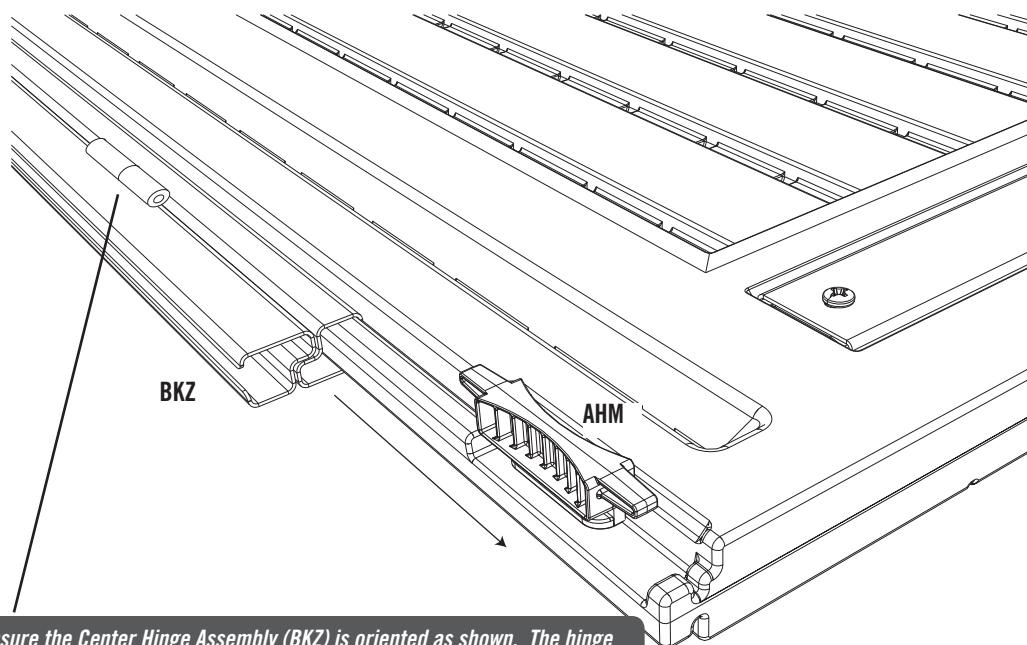

Note: Ensure the Center Hinge Assembly (BKZ) is oriented as shown. The hinge goes toward the back of the door.

SEC

7.4

Align the holes in the center of the Center Hinge Assembly with the notch in the edge of the Left Door. Secure The Center Hinge Assembly to the Left Door using the required hardware.

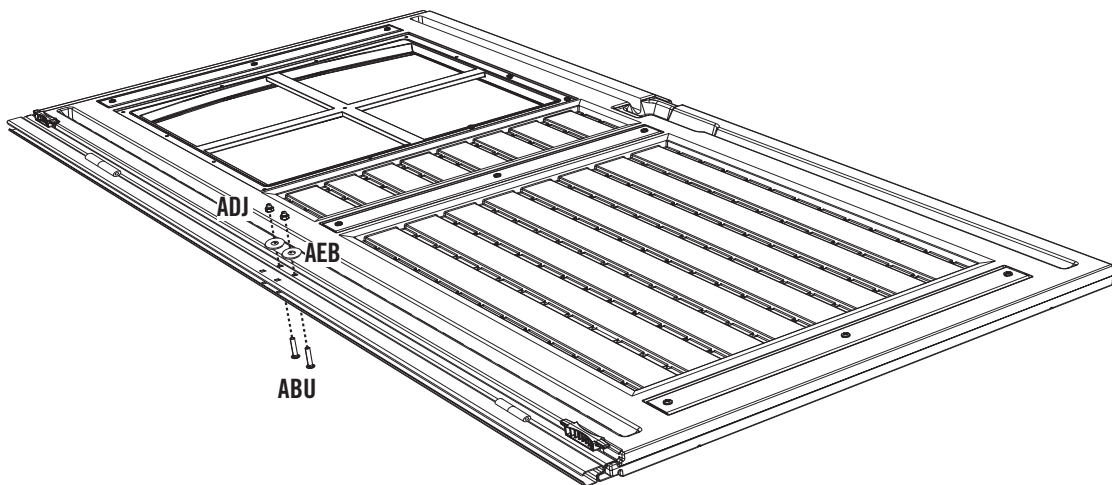

SEC 8 CENTER DOOR ASSEMBLY

HARDWARE REQUIRED

Hardware shown at actual size

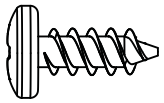

ADZ (x9)
1/4" x 5/8" Pan-Head Screw

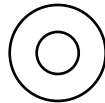

AEE (x1)
#10 x 1/2" Flat Washer

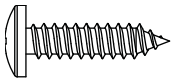

ADW (x3)
#10 x 3/4" Pan-Head Screw

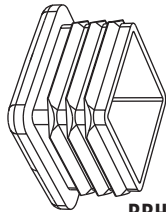

BBH (x2)
End Plug

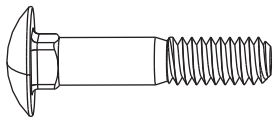

BQP (x2)
1/4" x 1 1/4" Carriage Bolt



ADJ (x2)
1/4" Cap Nut

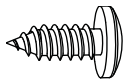

ADX (x2)
#10 x 1/2" Pan-Head Screw

HARDWARE BAG REQUIRED: BMV

Hardware shown at 15% of actual size



AHZ (x1)
Center Door Handle

Hardware shown at 25% of actual size

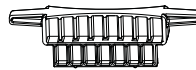

AHM (x1)
Dead Bolt Latch

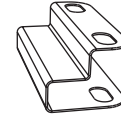

AIB (x1)
Extended Strike Plate

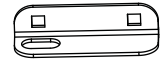

AIA (x1)
Center Door Lock Bracket

Hardware shown at 50% of actual size

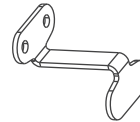

BBI (x1)
Inside Center Door Handle

METAL PARTS REQUIRED

LOCATED IN BOX 1 AND METAL PARTS KIT: BNN

Part shown at 8% of actual size

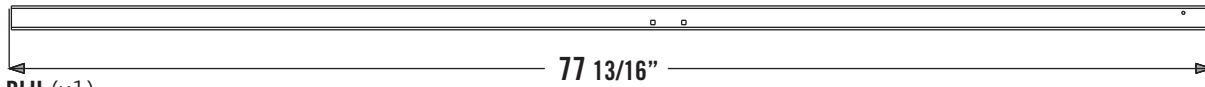

BLH (x1)
Extended Door End Channel

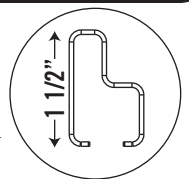

BLG (x1)
Extended Door Brace

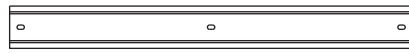

AFB (x2)
Door Brace

PLASTIC PARTS REQUIRED

LOCATED IN BOX: 5

Part shown at 4% of actual size

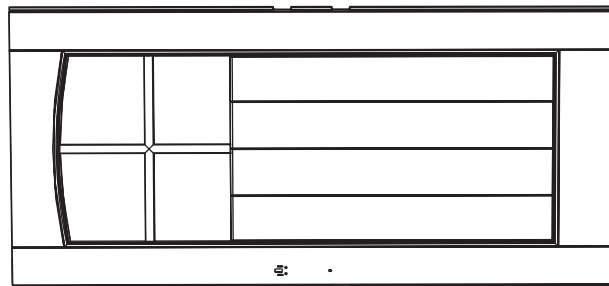

AGZ (x1)
Center Door
(The Center and Right Doors are the same part)

TOOLS REQUIRED



Phillips Screwdriver



7/16" Wrench



Safety Glasses



TOOLS AND HARDWARE REQUIRED FOR THIS PAGE

SEC 8

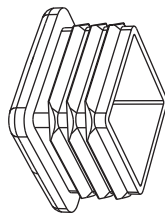

BBH (x2)



SEC

CENTER DOOR ASSEMBLY

8.1

Insert an **End Plug (BBH)** into each end of the **Extended Door Brace (BLG)**, as shown.

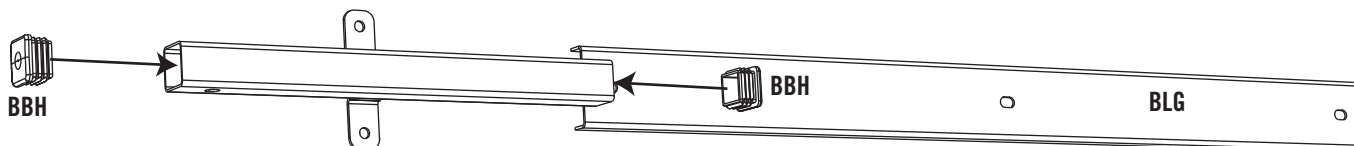

SEC

8.2

Secure two (2) **Door Braces (AFB)** and the **Extended Door Brace (BLG)** to the inside of the **Center Door (AGZ)**, as shown, using the required hardware.

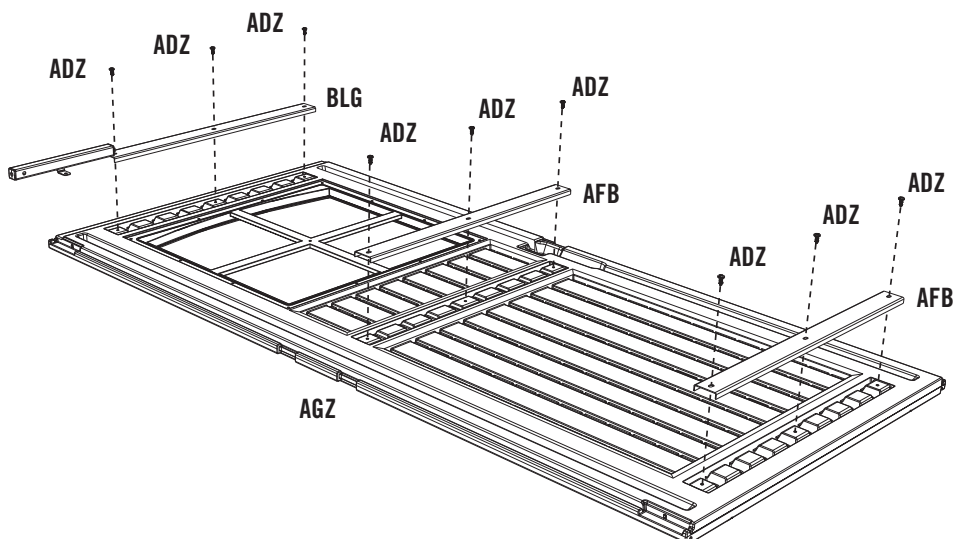



TOOLS AND HARDWARE REQUIRED FOR THIS PAGE

SEC 8

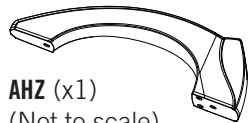

AHZ (x1)
(Not to scale)



ADW (x3)

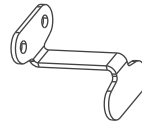

BBI (x1)
(Not to scale)

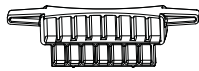

AHM (x1)
(Not to scale)

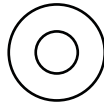

AEE (x1)



SEC

8.3

Connect the **Center Door Handle (AHZ)** and the **Inside Center Door Handle (BBI)** to the Center Door using the hardware shown.

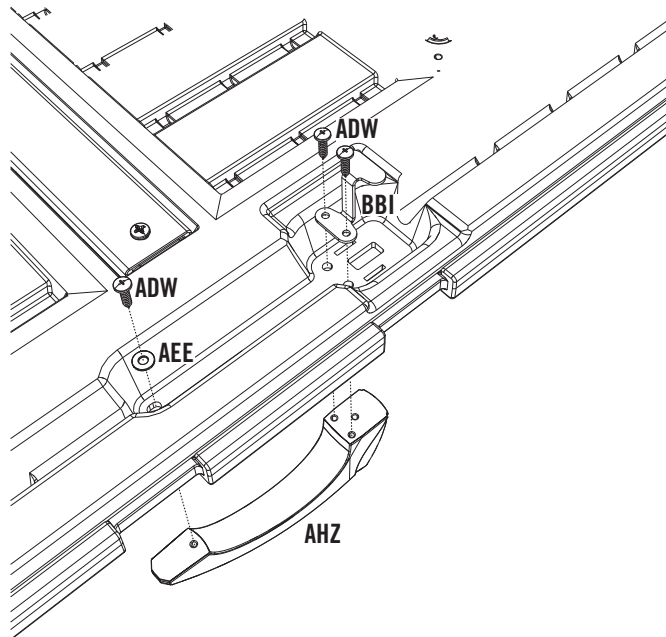

SEC

8.4

Orient the **Extended Door End Channel (BLH)**, as shown, and slide the Channel down over the edge of the Center Door. Insert a **Dead Bolt Latch (AHM)** into the notch at the bottom of the Center Door, as shown. Slide the Extended Door End Channel over the Latch.

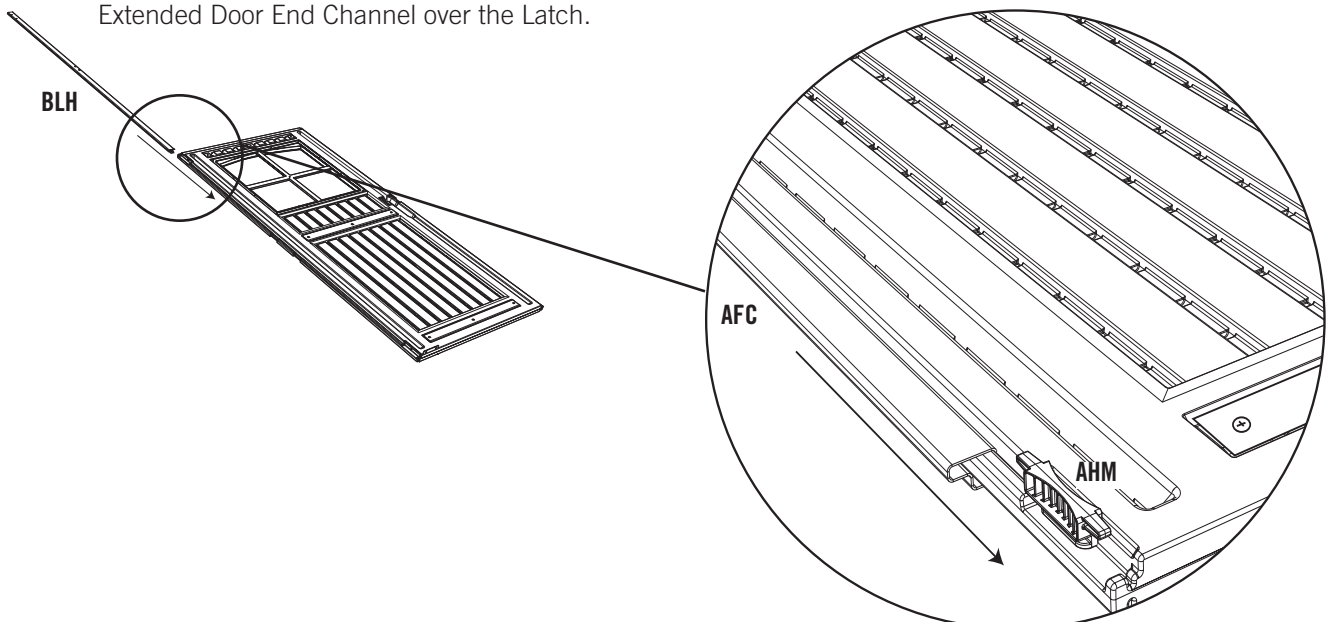



TOOLS AND HARDWARE REQUIRED FOR THIS PAGE

SEC 8



7/16"

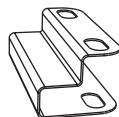

AIB (x1)
(Not to scale)

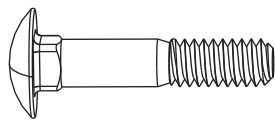

BQP (x2)



ADJ (x2)



AIA (x1)
(Not to scale)



SEC

8.5

Orient the **Extended Strike Plate (AIB)** and slide it over the holes in the Extended Door End Channel, as shown.

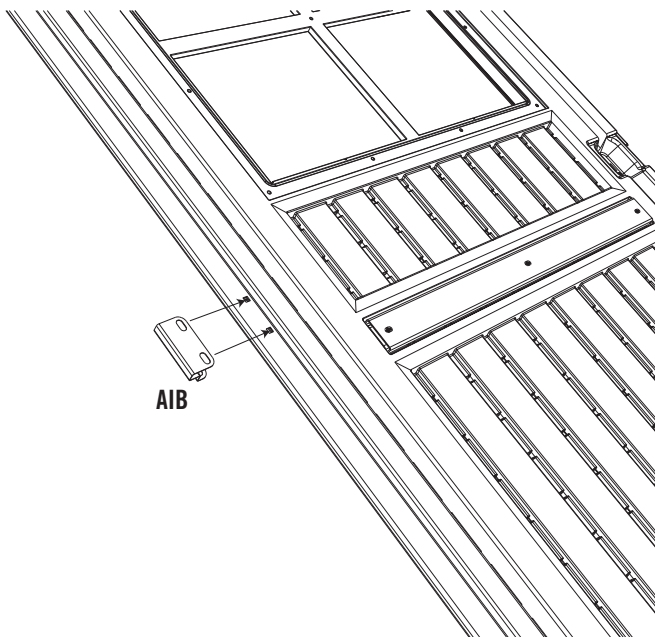

SEC

8.6

Secure the Extended Strike Plate, Extended Door End Channel, and **Center Door Lock Bracket (AIA)** to the Center Door using the required hardware.

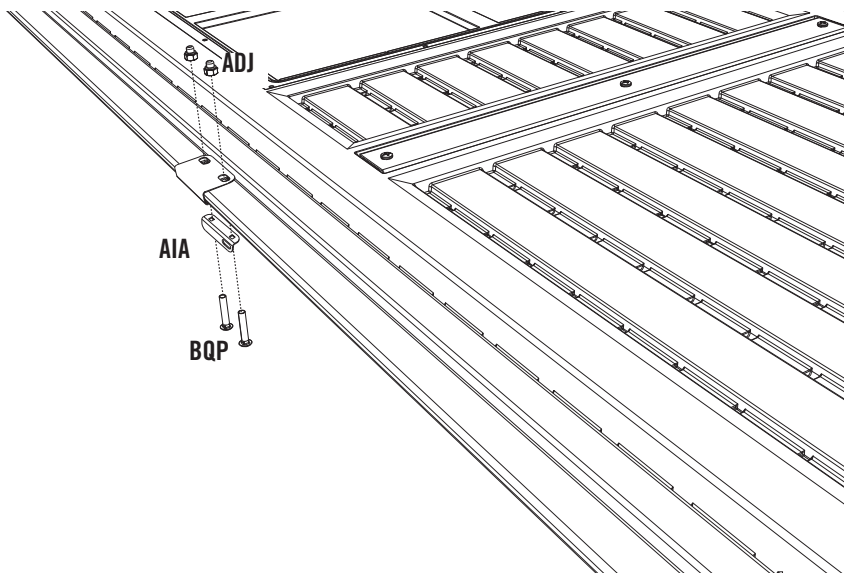

WARNING

Do not overtighten the Cap Nut. If the end of the Bolt breaks through the plastic cap, call our Customer Service Department. Exposed threads on the end of the Bolt may cause serious injuries.



TOOLS AND HARDWARE REQUIRED FOR THIS PAGE

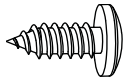

ADX (x2)

SEC 8



SEC

8.7

Align the holes in the Extended Door Brace with those in the Extended Door End Channel, and secure using the required hardware.

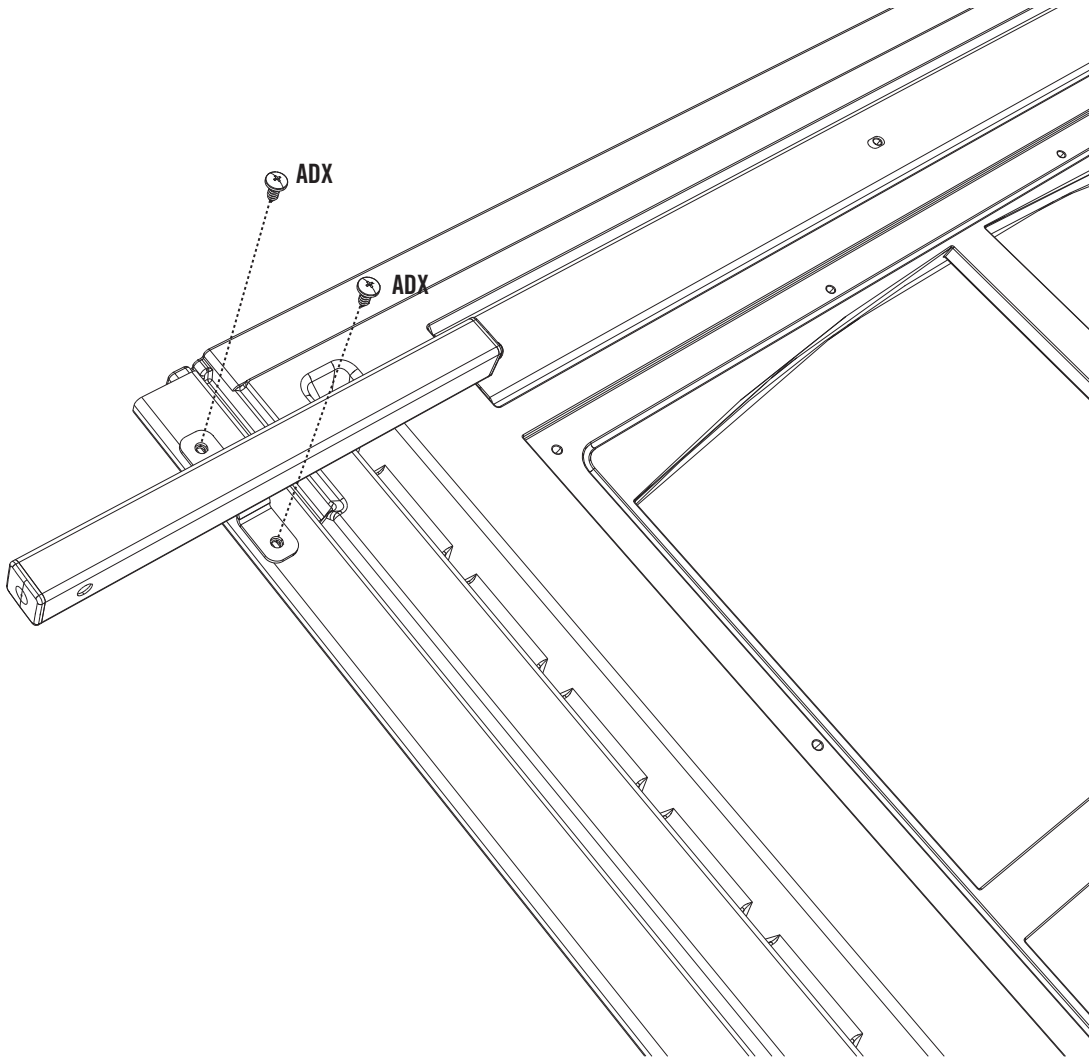

SEC 9 RIGHT DOOR ASSEMBLY

HARDWARE REQUIRED

Hardware shown at actual size

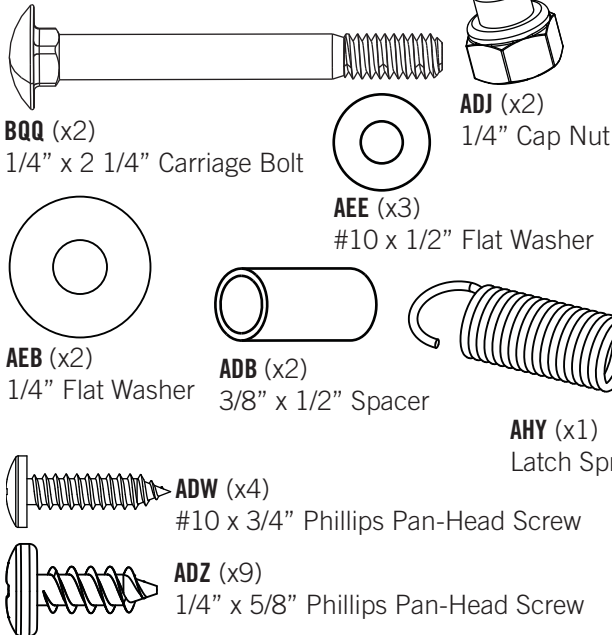

HARDWARE BAG REQUIRED: BMU

Hardware shown at 25% of actual size

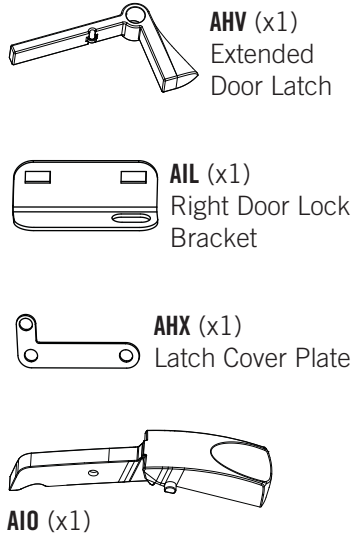

Hardware shown at 15% of actual size

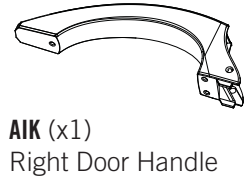

Hardware shown at 50% of actual size

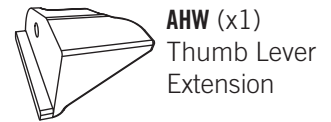

METAL PARTS REQUIRED

LOCATED IN BOX 1 AND METAL PARTS KIT: BNN

Part shown at 8% of actual size

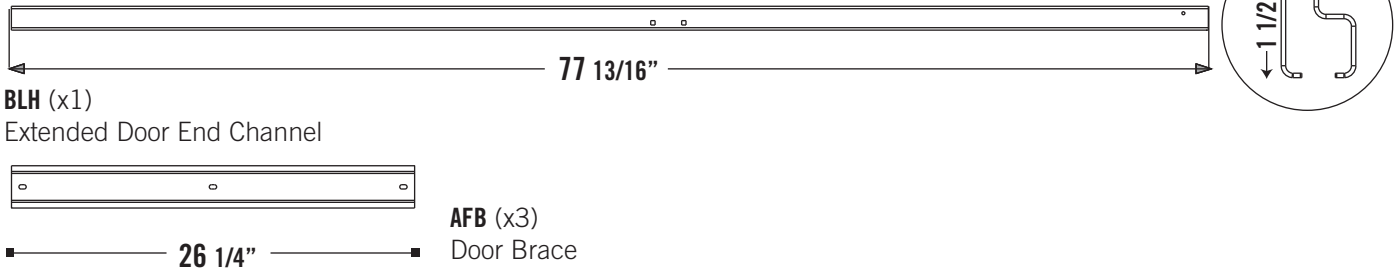

PLASTIC PARTS REQUIRED

LOCATED IN BOX: 5

Part shown at 4% of actual size

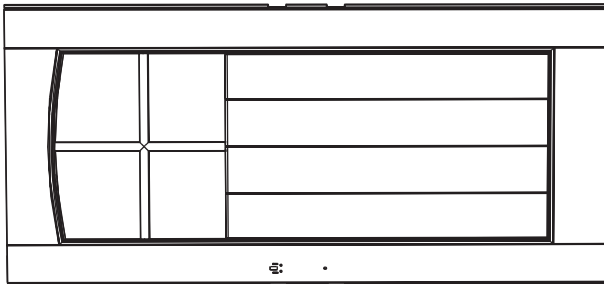

AGZ (x1)
Right Door
(The Right and Center Doors are the same part)

TOOLS REQUIRED





TOOLS AND HARDWARE REQUIRED FOR THIS PAGE

SEC 9

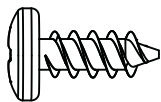

ADZ (x9)



SEC

RIGHT DOOR ASSEMBLY

9.1

Secure three (3) **Door Braces (AFB)** to the inside of the **Right Door (AGZ)** using the required hardware.

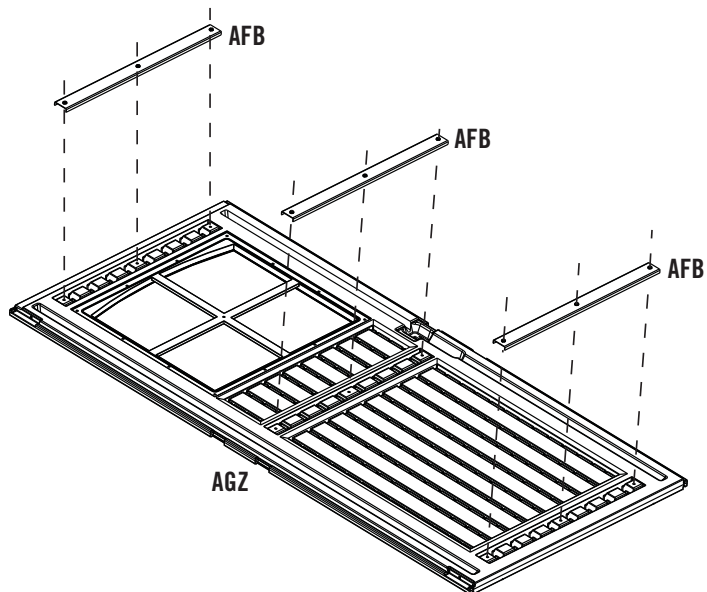

SEC

9.2

Slide a **Extended Door End Channel (BLH)** down over the edge of the Right Door as shown.

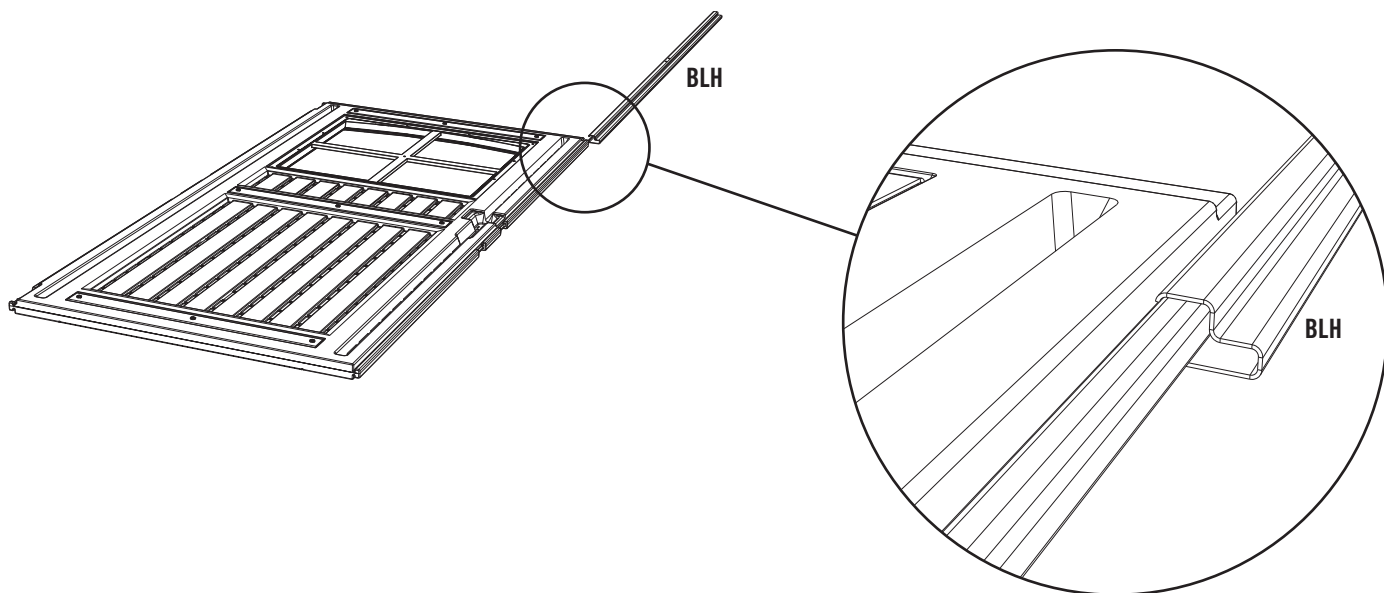



TOOLS AND HARDWARE REQUIRED FOR THIS PAGE

SEC 9

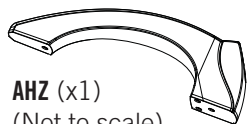

AHZ (x1)
(Not to scale)



ADW (x3)

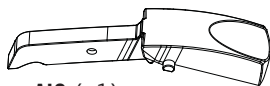

AIO (x1)
(Not to scale)

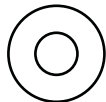

AEE (x3)



SEC

9.3

Slide the nubs of the **Thumb Lever (AIO)** down the slots and into the holes of the **Right Door Handle (AIK)**.

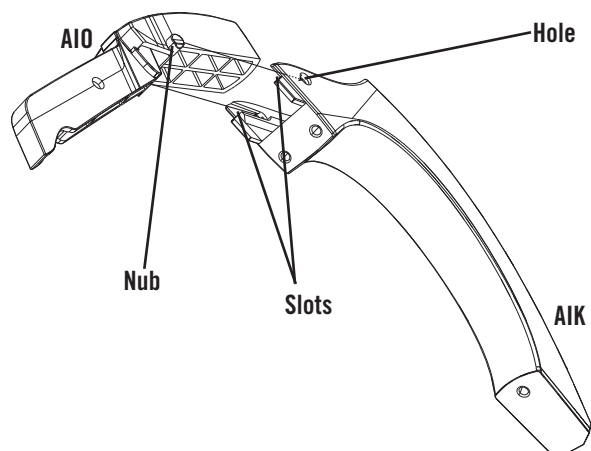

SEC

9.4

Insert the end of the Thumb Lever through the slot in the Right Door and connect the Door Handle Assembly to the Right Door using the hardware shown.

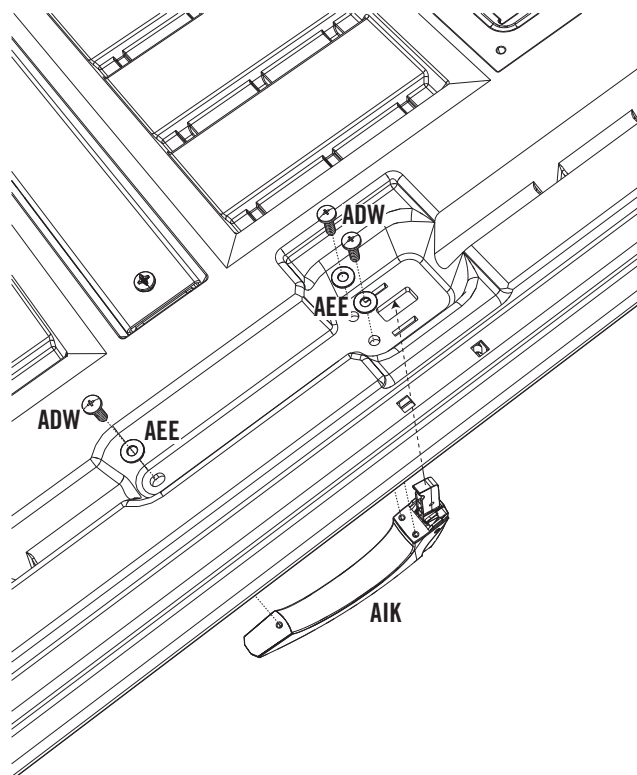



TOOLS AND HARDWARE REQUIRED FOR THIS PAGE

SEC 9

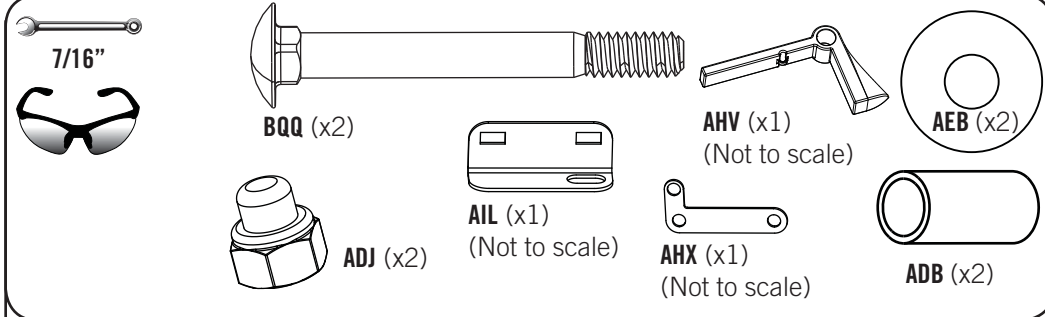

SEC

9.5

Align the holes in the center of the Extended Door End Channel with the notch in the edge of the Right Door. Connect the **Right Door Lock Bracket (AIL)**, **Extended Door Latch (AHV)**, and **Latch Cover Plate (AHX)** to the Right Door as shown using the required hardware.

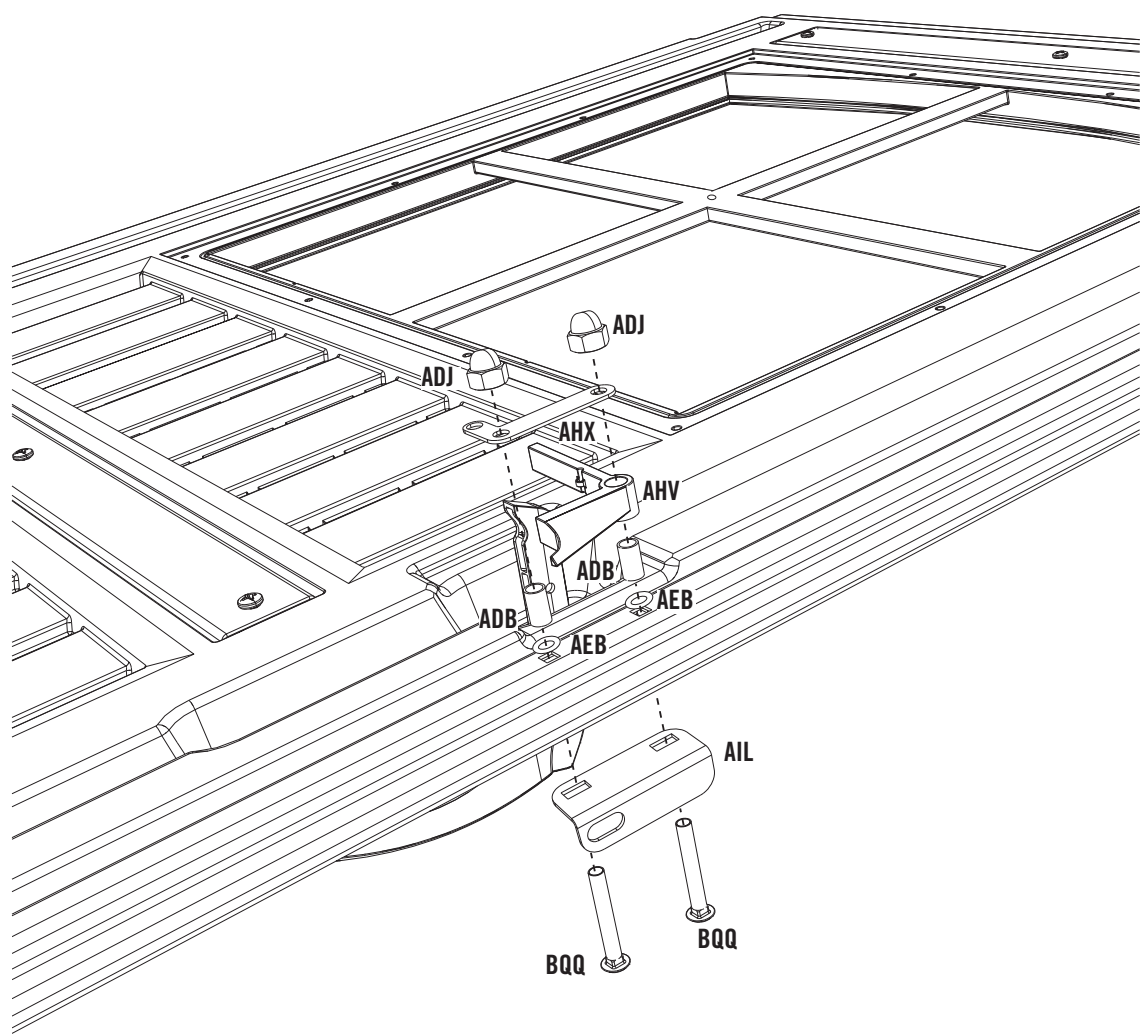



TOOLS AND HARDWARE REQUIRED FOR THIS PAGE

SEC 9

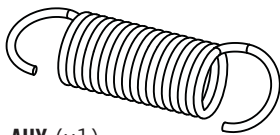

AHY (x1)

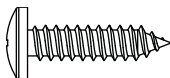

ADW (x1)

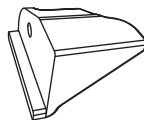

AHW (x1)
(Not to scale)



SEC

9.6

Connect the **Thumb Lever Extension (AHW)** to the Thumb Lever with one (1) **#10 x 3/4" Phillips Pan-Head Screw (ADW)**.

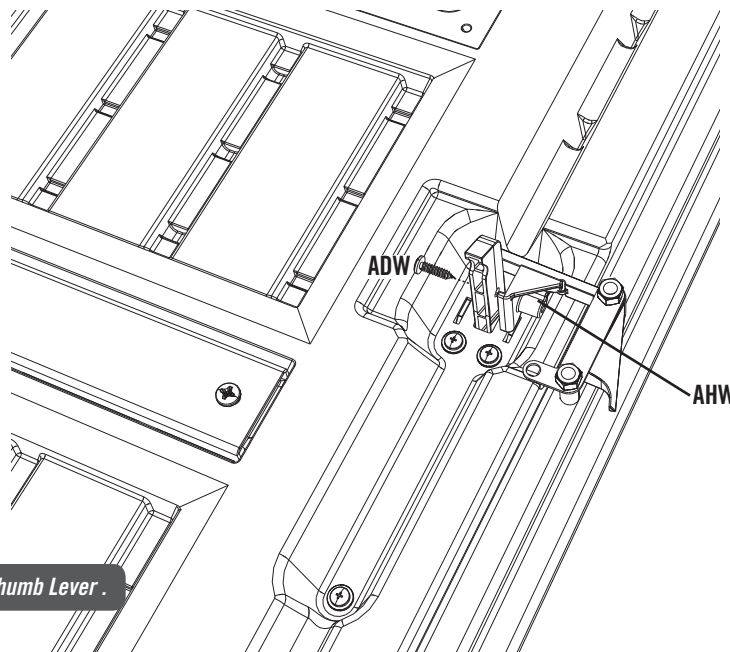

Note: The lip of the Thumb Lever Extension (AHW) fits under the Thumb Lever.

SEC

9.7

Connect the **Latch Spring (AHY)** to the **Extended Door Latch (AHV)** and **Latch Cover Plate (AHX)**.

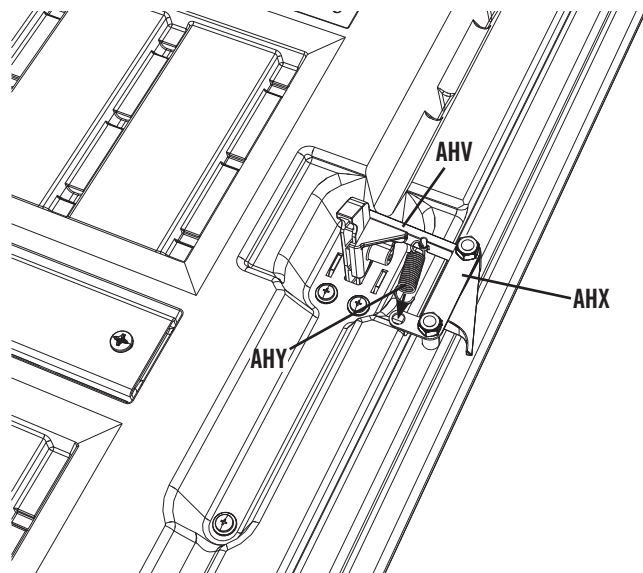

Note: Use pliers to pull spring down and hook into bottom hole.



WARNING

While performing this step, each person should use protective eye glasses to help prevent serious eye injury.

10 DOOR FRAME AND DOOR INSTALLATION

HARDWARE REQUIRED

HARDWARE BAG REQUIRED: BNE

Hardware shown at actual size

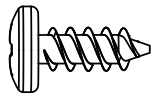

ADZ (x13)
1/4" x 5/8" Pan-Head Screw

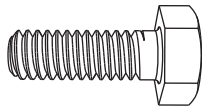

BBL (x6)
1/4" x 3/4" Hex Bolt

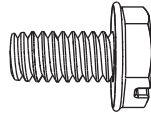

BBM (x4)
1/4" x 1/2" Thread Cutting Screw

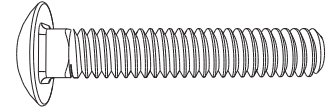

ABU (x6)
1/4" x 1 1/2" Carriage Bolt

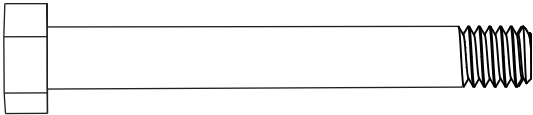

BBG (x1)
5/16" x 2 1/2" Hex Bolt

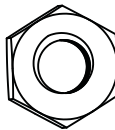

AAV (x2)
5/16" Jam Nut

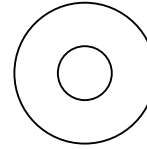

AEB (x8)
1/4" Flat Washer

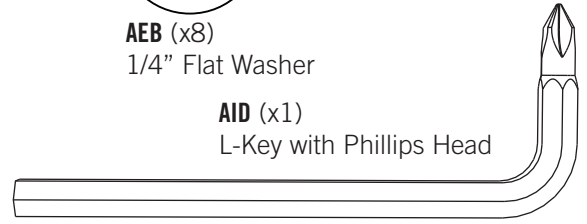

AID (x1)
L-Key with Phillips Head

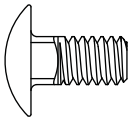

ACA (x4)
1/4" x 1/2" Carriage Bolt



ADJ (x16)
1/4" Cap Nut

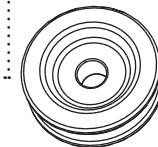

BBE (x2)
Carriage Wheel



AHL (x2)
Dead Bolt Strike Plate

Part shown at 25% of actual size

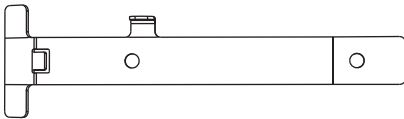

BBN (x1)
Carriage Latch

Parts shown at 50% of actual size

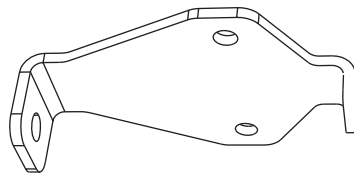

BBK (x1)
Carriage Bracket



BBJ (x1)
4" Floor Strike Plate

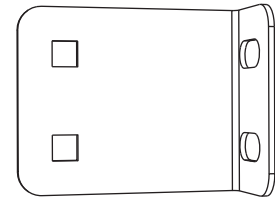

CJR (x2)
Door Frame Support Bracket

METAL PARTS REQUIRED

LOCATED IN BOX 4 AND METAL PARTS KIT: BNM

Parts shown at 8% of actual size

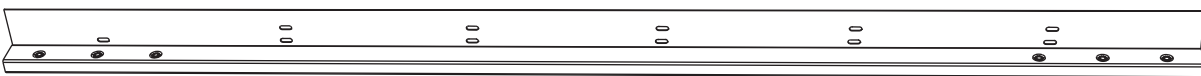

78 1/4"

BLJ (x2)
Corner Door Frame

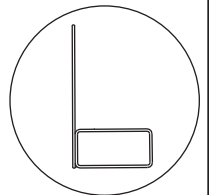

Top



78 1/4"

BMG (x1)
Right Hinge Assembly

Bottom

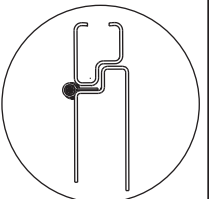

METAL PARTS REQUIRED

LOCATED IN BOX 1 AND METAL PARTS KIT: BNM, BNN

Parts shown at 8% of actual size

Top **Bottom**

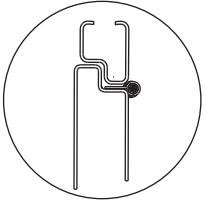
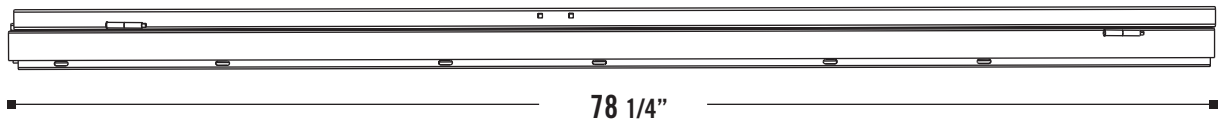

BLK (x1)
Left Hinge Assembly

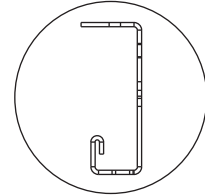
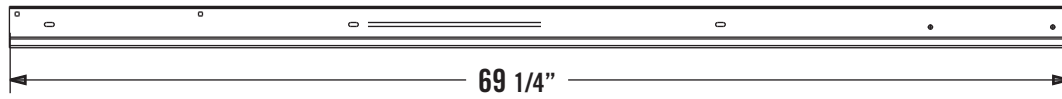

BLL (x1)
Long Glider Track

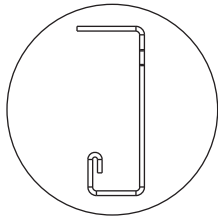
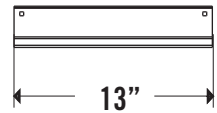

BLM (x1)
Short Glider Track

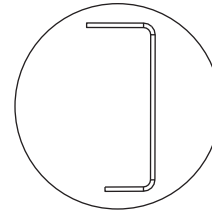
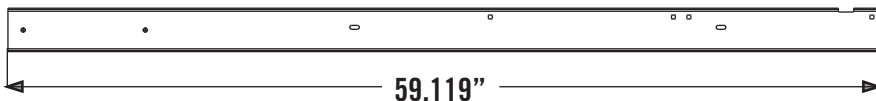

BLN (x1)
Glider Track Extension

Part shown at 15% of actual size

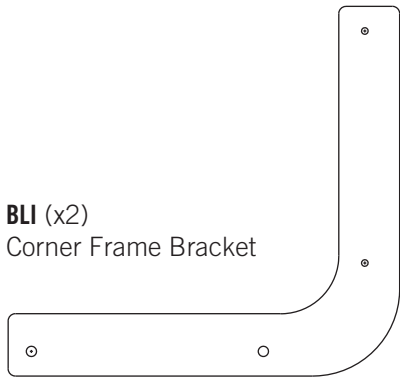

BLI (x2)
Corner Frame Bracket

TOOLS REQUIRED

HARDWARE BAG REQUIRED: BNE

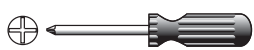

Phillips Screwdriver



AID (x1) (Not to scale)



7/16" Wrench



5/16" Wrench (x2)



Safety Glasses



TOOLS AND HARDWARE REQUIRED FOR THIS PAGE

SEC 10



NO HARDWARE REQUIRED FOR THIS PAGE



SEC

10.1

Ensure you use the correct Hinge Assembly for the Left and Right Doors. The hinge faces outward on each door, and the head of the hinge pin always goes on top.

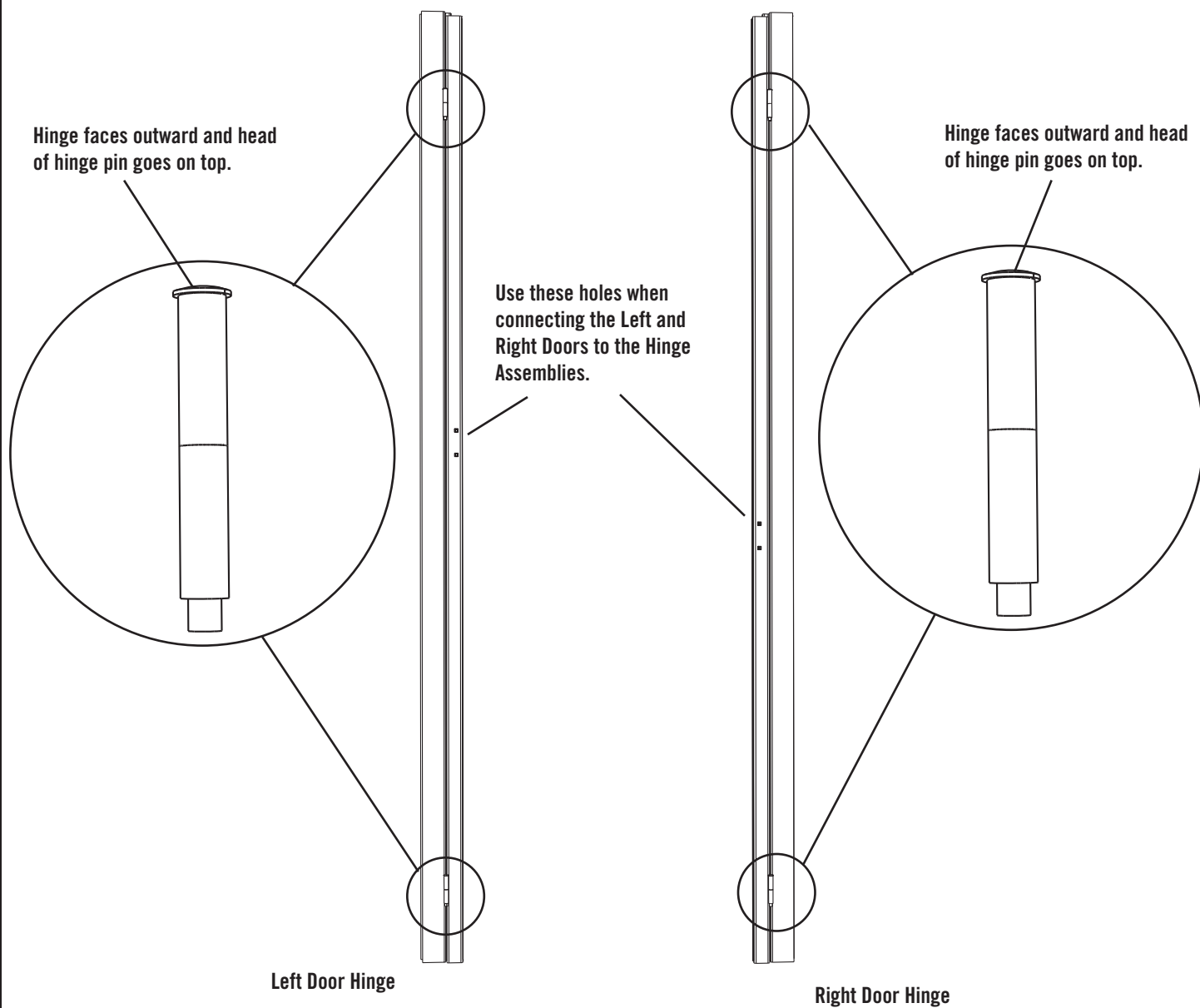



TOOLS AND HARDWARE REQUIRED FOR THIS PAGE

SEC 10



NO HARDWARE REQUIRED FOR THIS PAGE



SEC

10.2

LEFT DOOR ASSEMBLY

Slide the Left Door Assembly down through the channel of a **Left Hinge Assembly (BLK)** as shown.

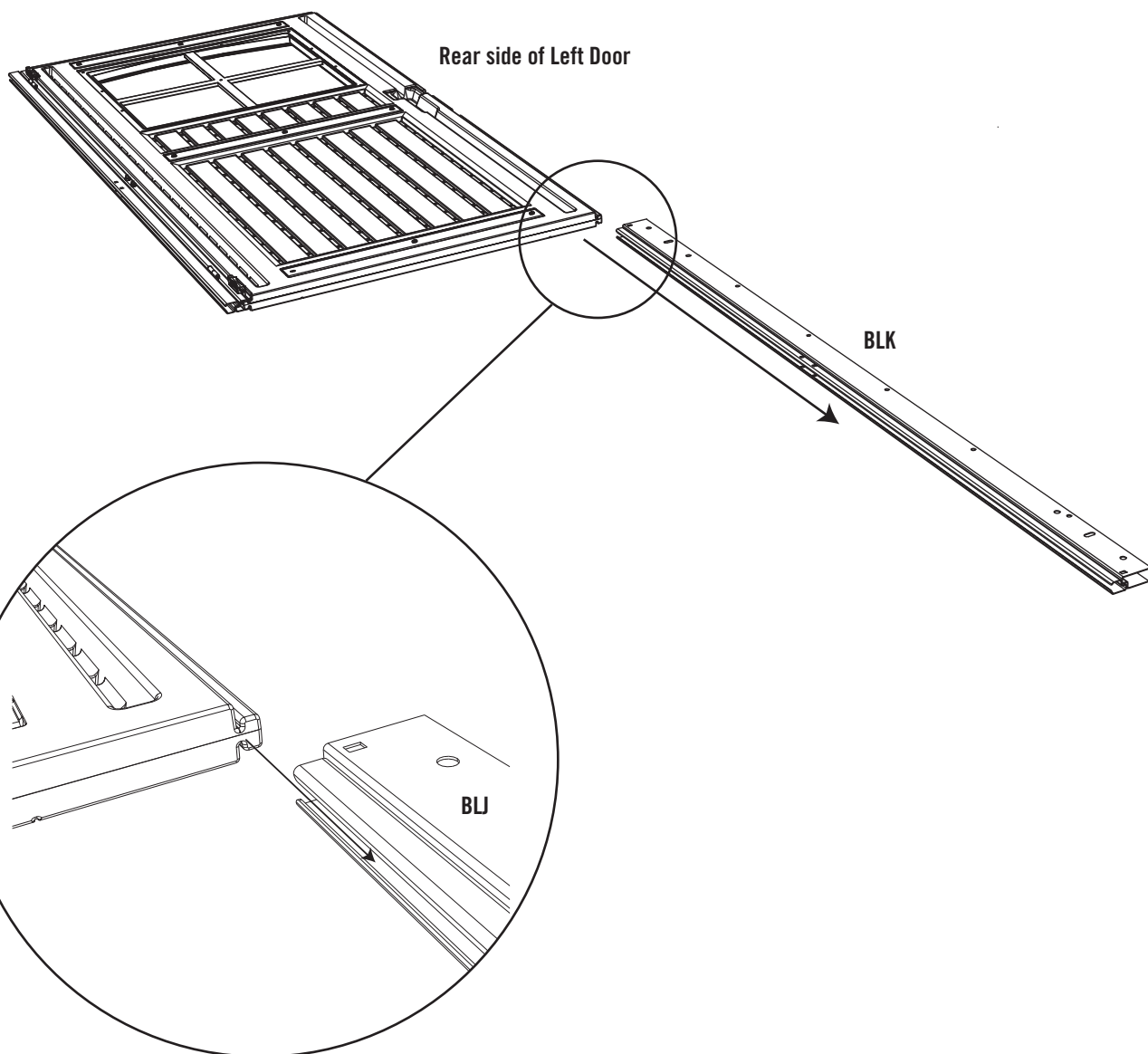



TOOLS AND HARDWARE REQUIRED FOR THIS PAGE

SEC 10



7/16"

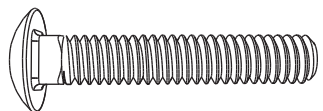

ABU (x2)

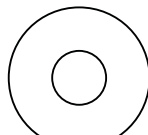

AEB (x2)



ADJ (x2)



SEC

10.3

Align the holes in the Left Hinge Assembly with the notch in the Left Door, and secure the Left Hinge Assembly to the Left Door using the required hardware.

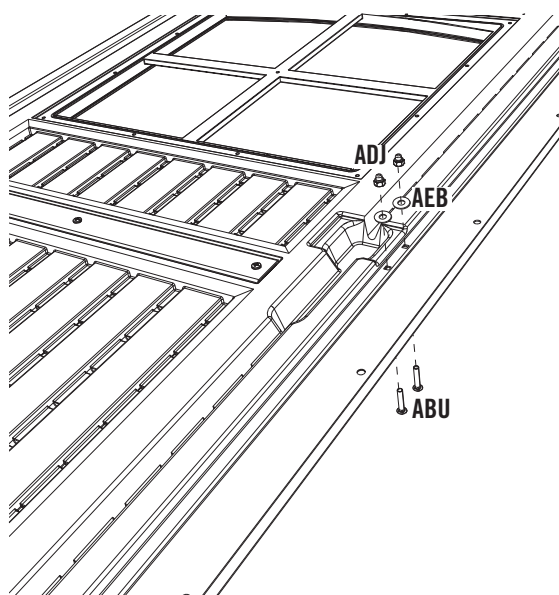

SEC

10.4

Slide a **Corner Door Frame (BLJ)** into the Left Hinge Assembly, and align the holes, as shown.

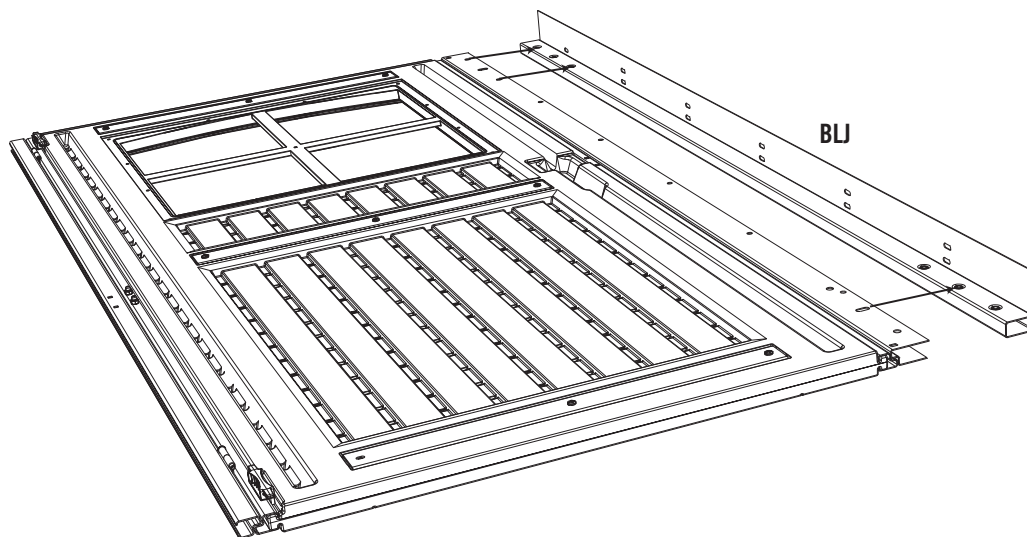



TOOLS AND HARDWARE REQUIRED FOR THIS PAGE

SEC 10



7/16"

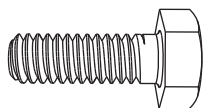

BBL (x3)

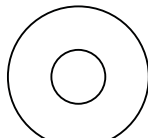

AEB (x1)



SEC

10.5

Secure a **Corner Frame Bracket (BLI)** to the Corner Door Frame and Left Hinge Assembly using the required hardware.

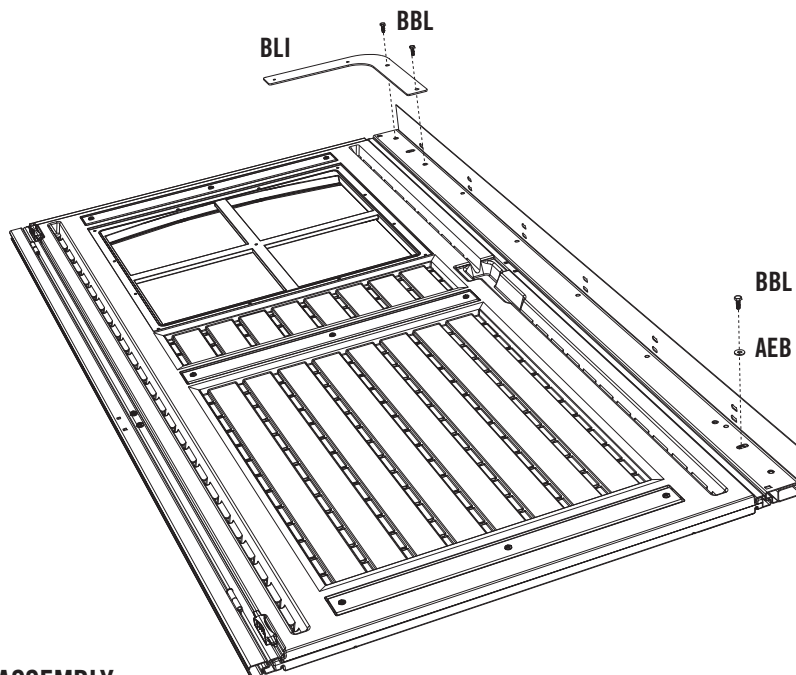

SEC

10.6

CENTER DOOR ASSEMBLY

Slide the Center Door Assembly down through the channel of the Door Hinge End Channel, as shown.

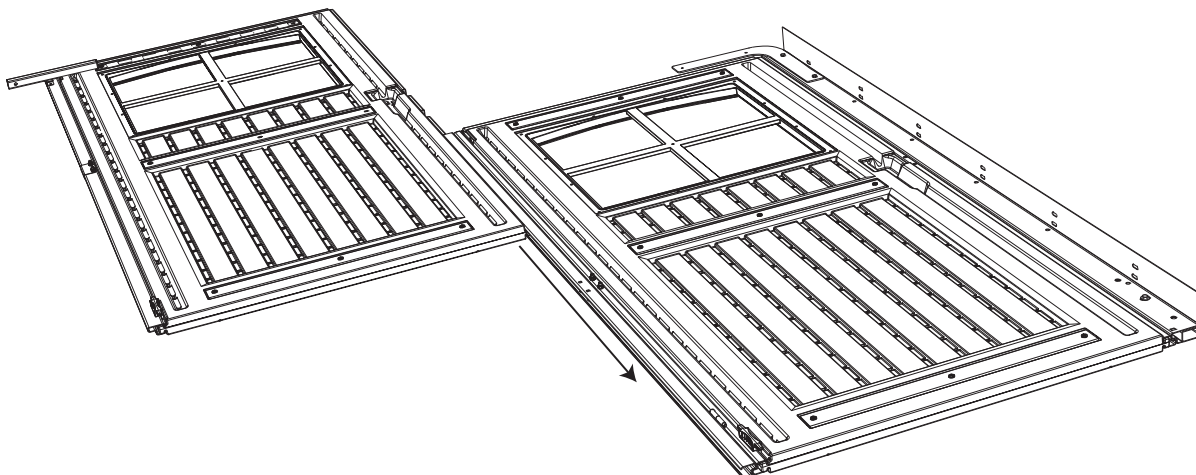



TOOLS AND HARDWARE REQUIRED FOR THIS PAGE

SEC 10



7/16"

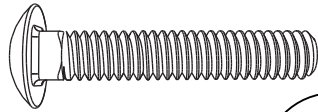

ABU (x2)

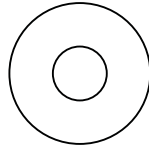

AEB (x2)

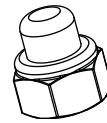

ADJ (x2)

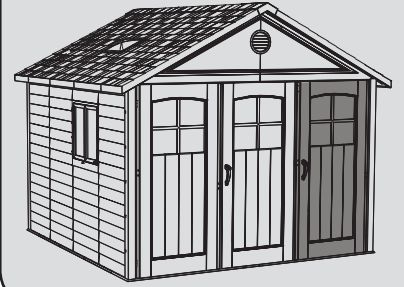

SEC

RIGHT DOOR ASSEMBLY

10.7

Orient the **Right Hinge Assembly (BMG)**, as shown. Slide the Hinge Frame down over the right side of the **Right Door (AGZ)**, as shown.

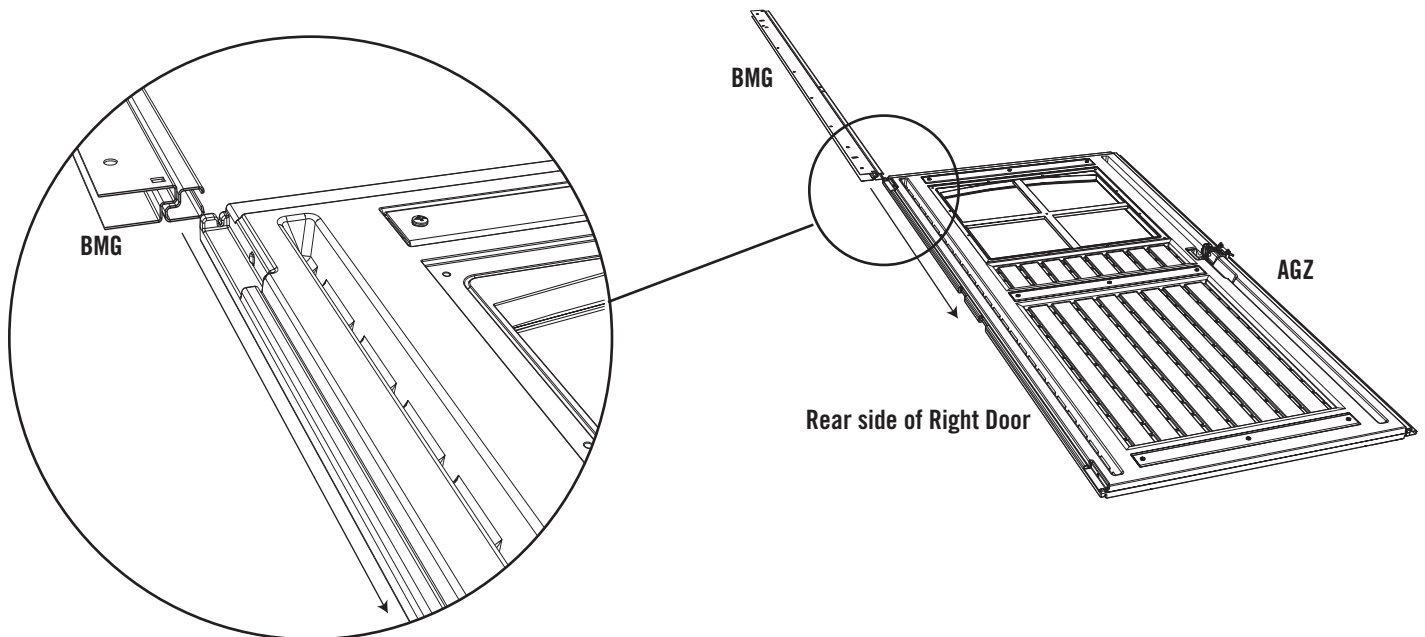

SEC

10.8

Align the holes in the Right Hinge Assembly with the notch in the Right Door, and secure the Right Hinge Assembly to the Right Door using the required hardware.

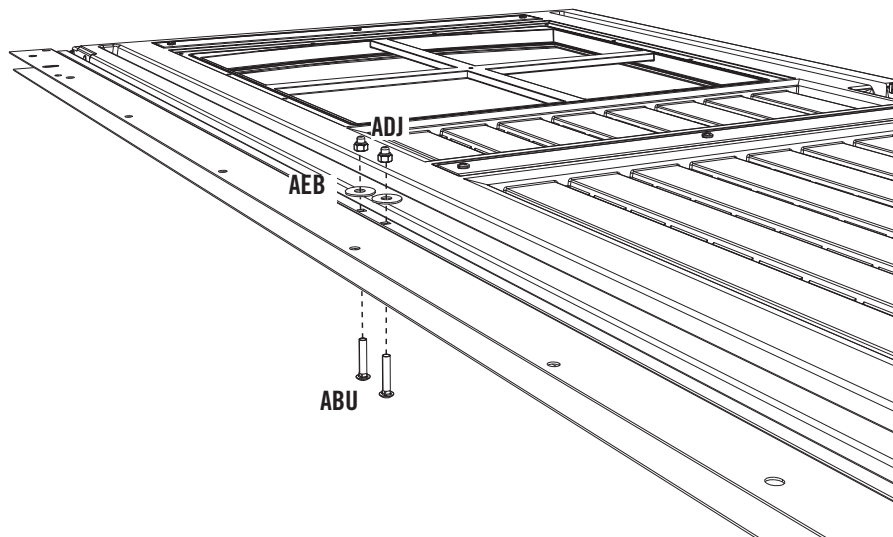



TOOLS AND HARDWARE REQUIRED FOR THIS PAGE

SEC 10



7/16"

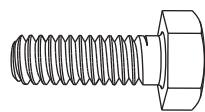

BBL (x3)

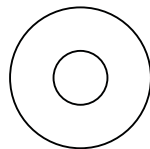

AEB (x1)

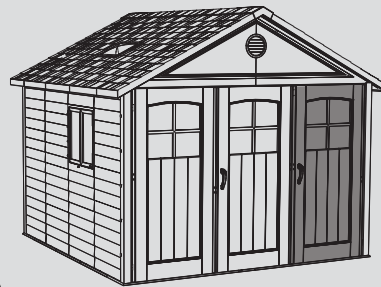

SEC

10.9

Slide the Right Hinge Assembly over a **Corner Door Frame (BLJ)** and align the holes, as shown.

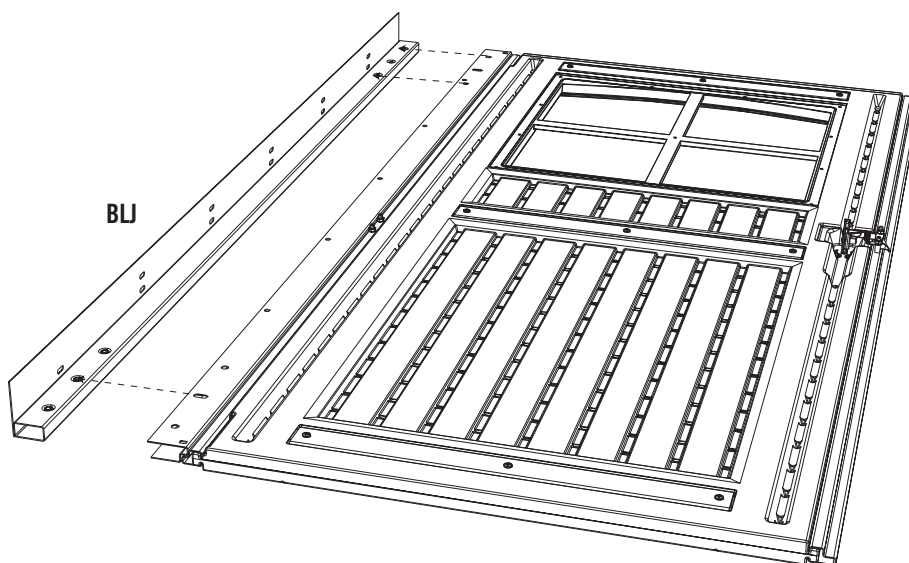

SEC

10.10

Secure a **Corner Frame Bracket (BLI)** to the Corner Door Frame and Right Hinge Assembly using the required hardware.

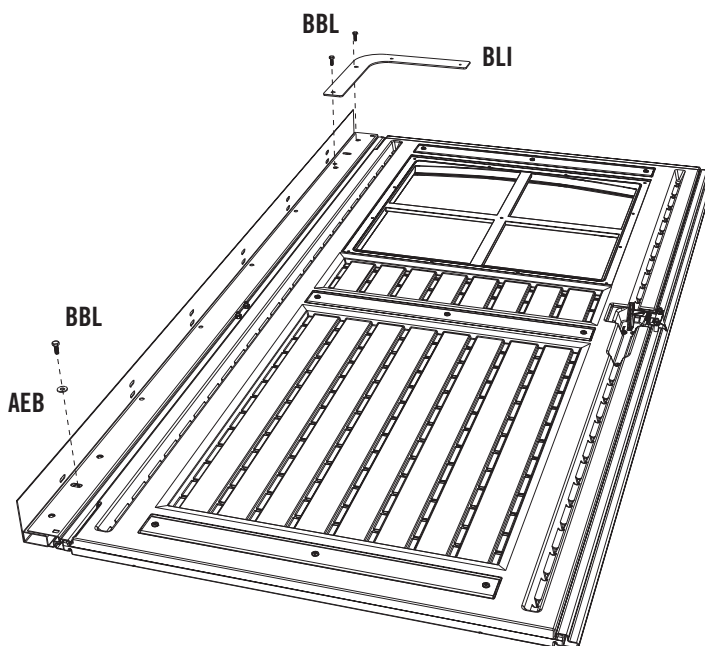



TOOLS AND HARDWARE REQUIRED FOR THIS PAGE

SEC 10



7/16"



ADJ (x4)

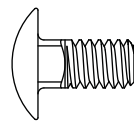

ACA (x4)



SEC

10.11

Slide the **Long Glider Track (BLL)** next to the **Short Glider Track (BLM)**.

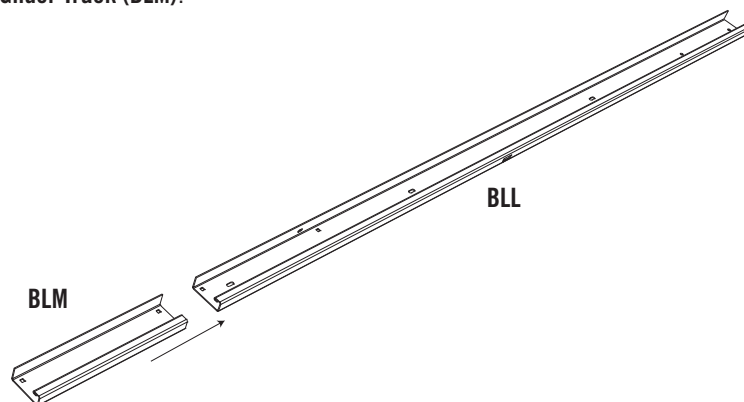

SEC

10.12

Align the square holes in the two Tracks with the square holes in **Glider Track Extension (BLN)** and connect the three pieces using the required hardware.

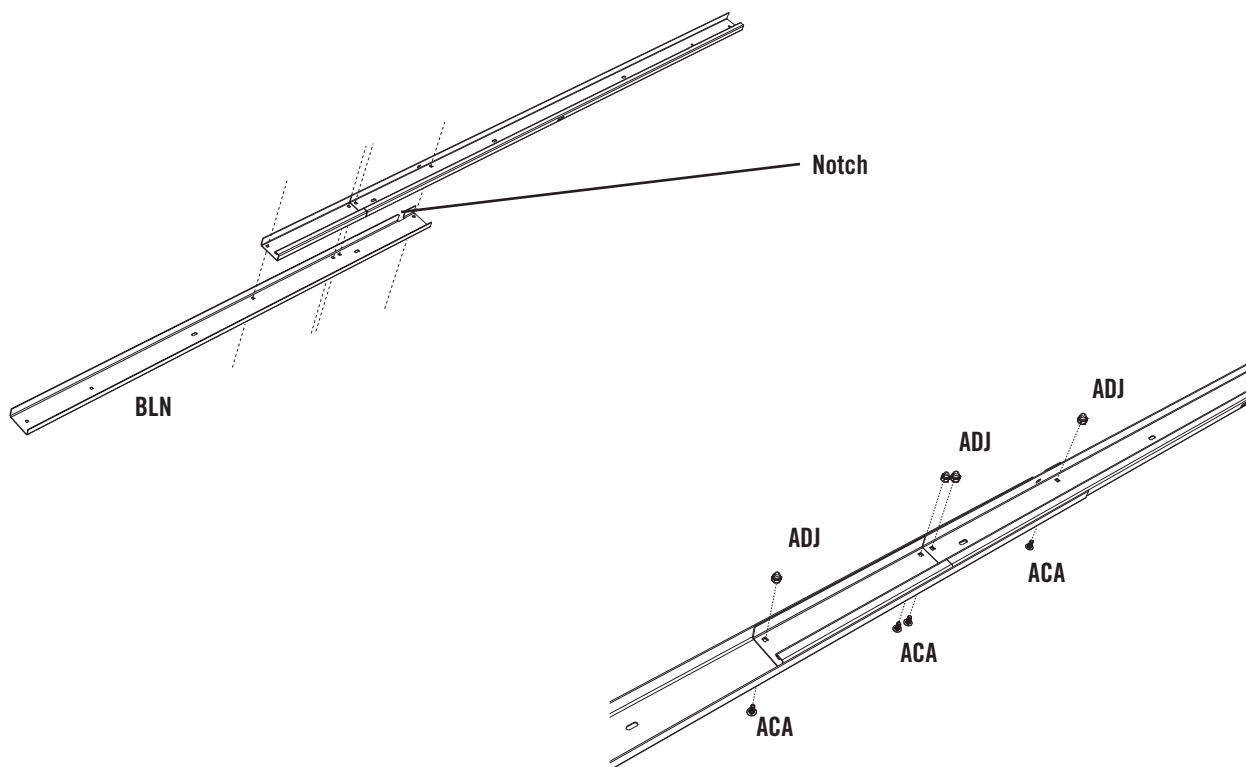



TOOLS AND HARDWARE REQUIRED FOR THIS PAGE

SEC 10



7/16"

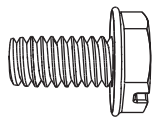

BBM (x4)



SEC

10.13

Place the Glider Track Assembly on the Corner Frame Brackets, as shown. The Long and Short Glider Tracks go over the Left and Center Doors.

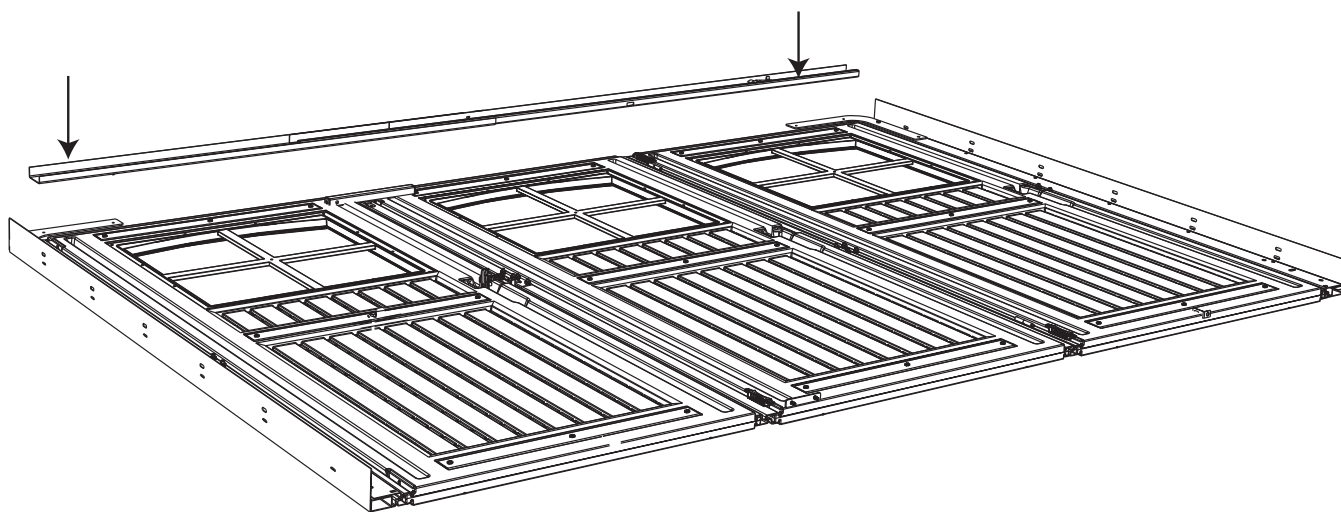

SEC

10.14

Connect the right side of the Top Door Frame Assembly to the right Corner Bracket using the required hardware. Connect the left side of the Top Door Frame Assembly and the Carriage Latch (BBN) to the left Corner Frame Bracket using the required hardware.

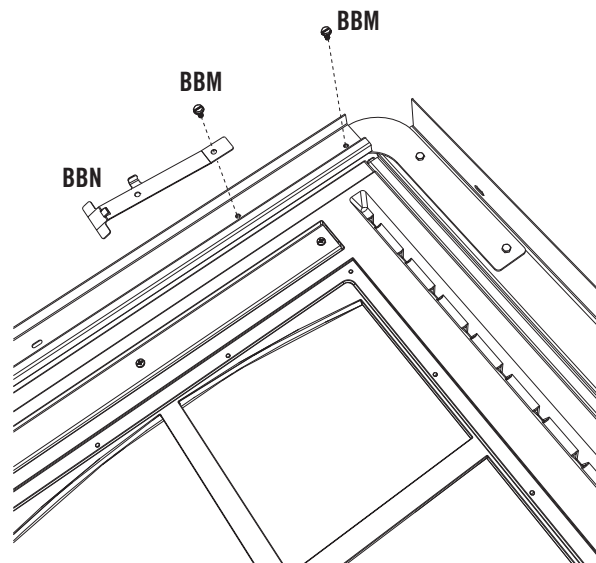
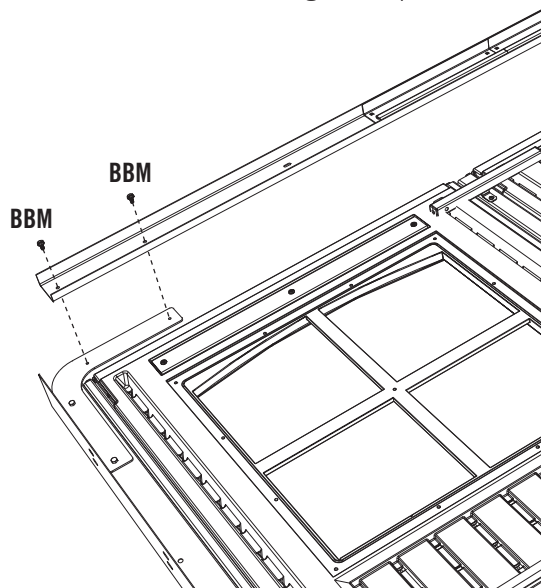



TOOLS AND HARDWARE REQUIRED FOR THIS PAGE

SEC 10



7/16"



AID (x1)
(Not to scale)



ADJ (x2)

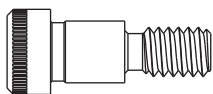

BBF (x2)

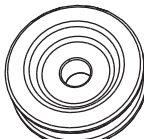

BBE (x2)
(Not to scale)



SEC

10.15

Connect both **Carriage Wheels (BBE)** to the **Carriage Bracket (BBK)** to form the Carriage Assembly using the required hardware. **Do not overtighten.**

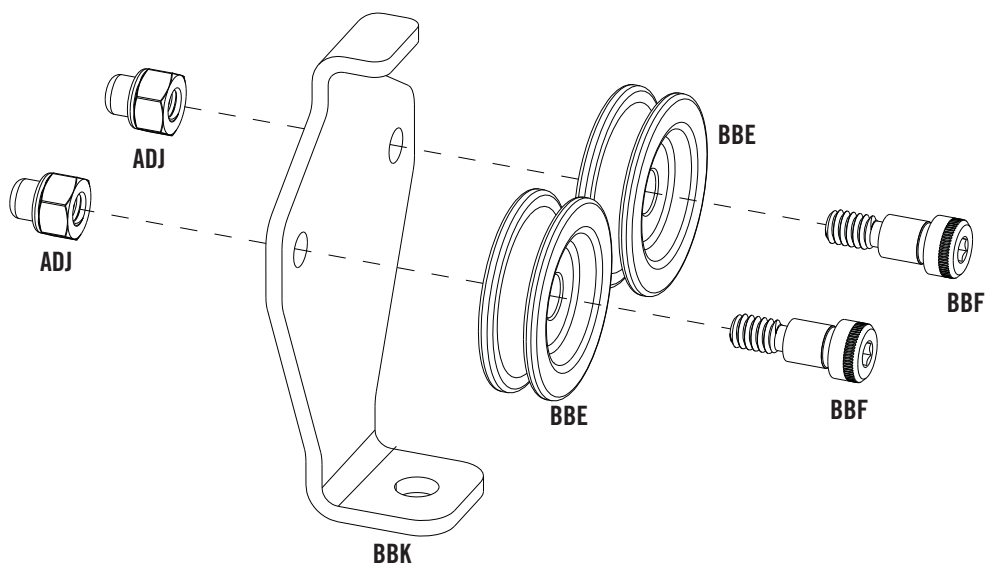

SEC

10.16

Place the Carriage Wheels into the Header Frame Track Assembly.

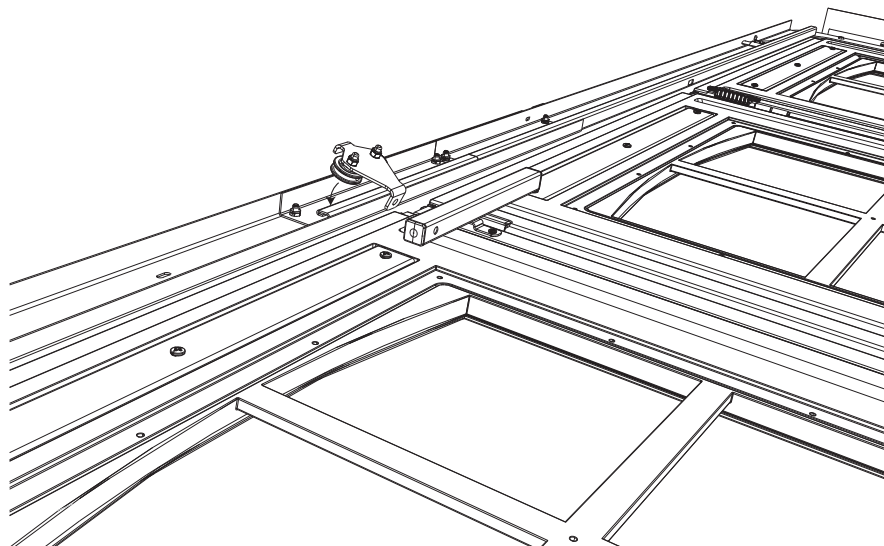



TOOLS AND HARDWARE REQUIRED FOR THIS PAGE

SEC 10



5/16" (x2)

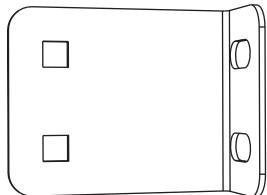

CJR (x2)
(Not to scale)

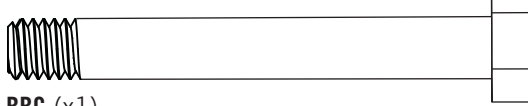

BBG (x1)



ADJ (x4)

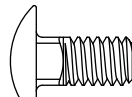

ACA (x4)

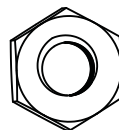

AAV (x2)



SEC

10.17

Connect the Carriage Bracket to the Extended Door Brace using one (1) 5/16" x 2 1/2" Hex Bolt (BBG) and two (2) 5/16" Jam Nuts (AAV). Place one (1) Jam Nut above the Carriage Bracket and one (1) below.

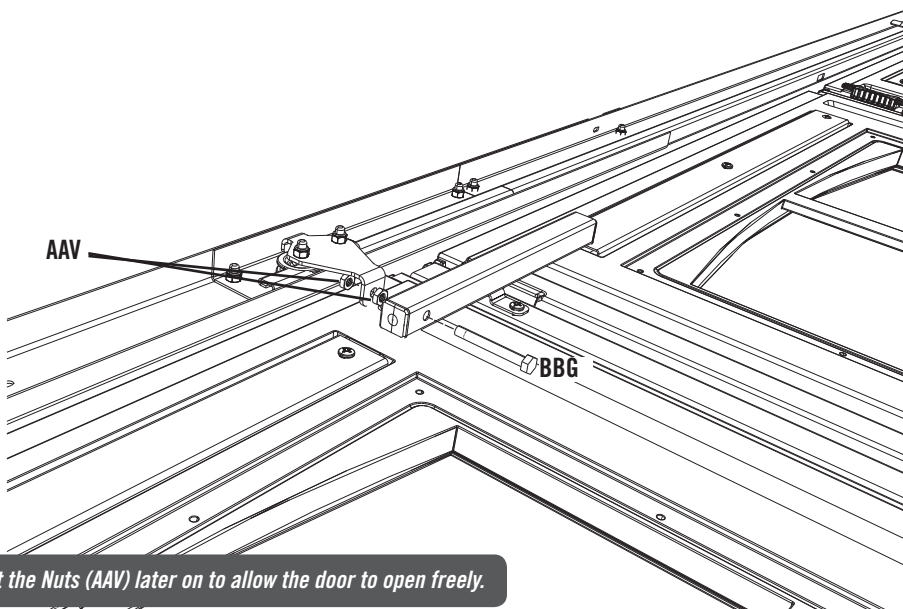

Note: You may need to adjust the Nuts (AAV) later on to allow the door to open freely.

SEC

10.18

Connect a Door Frame Support Bracket (CJR) to the bottom of the left Corner Door Frame (BLJ) using two (2) 1/4" x 1/2" Carriage Bolts (ACA) and two (2) 1/4" Cap Nuts (ADJ). Repeat this step for the right Corner Door Frame.

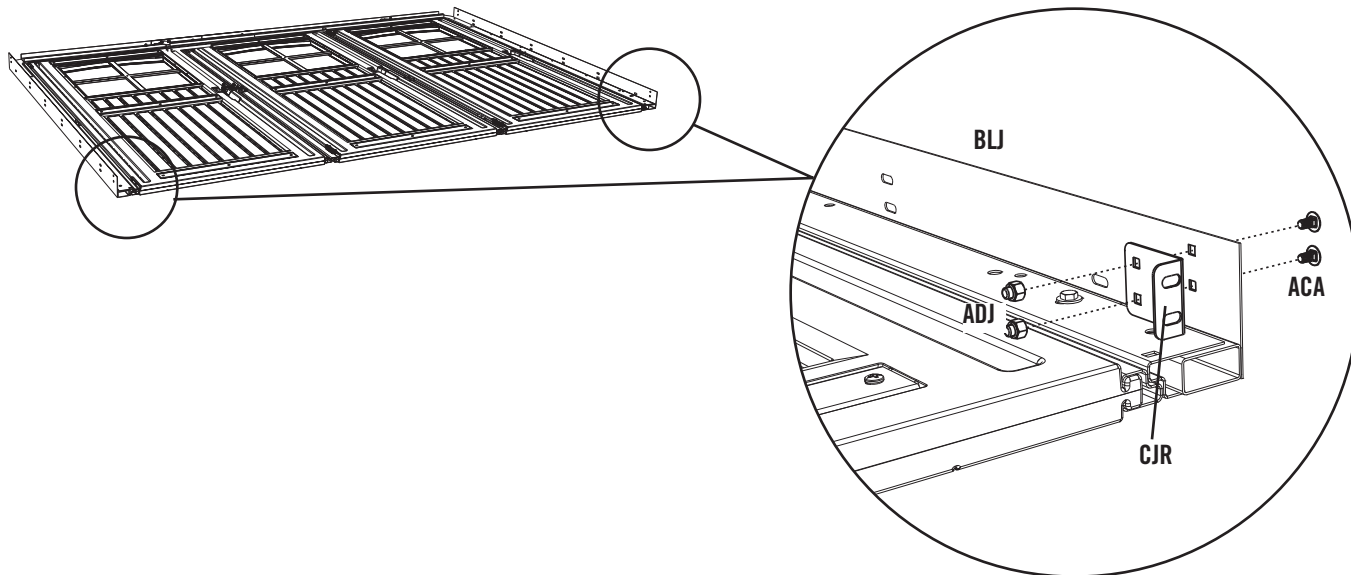



TOOLS AND HARDWARE REQUIRED FOR THIS PAGE

SEC 10



SEC

10.19

AT LEAST TWO ADULTS REQUIRED FOR STEPS ON THIS PAGE

Place the bottom of the Door/Frame Assembly next to the front Floor Panels of the shed, and lift the Door/Frame Assembly up in place.

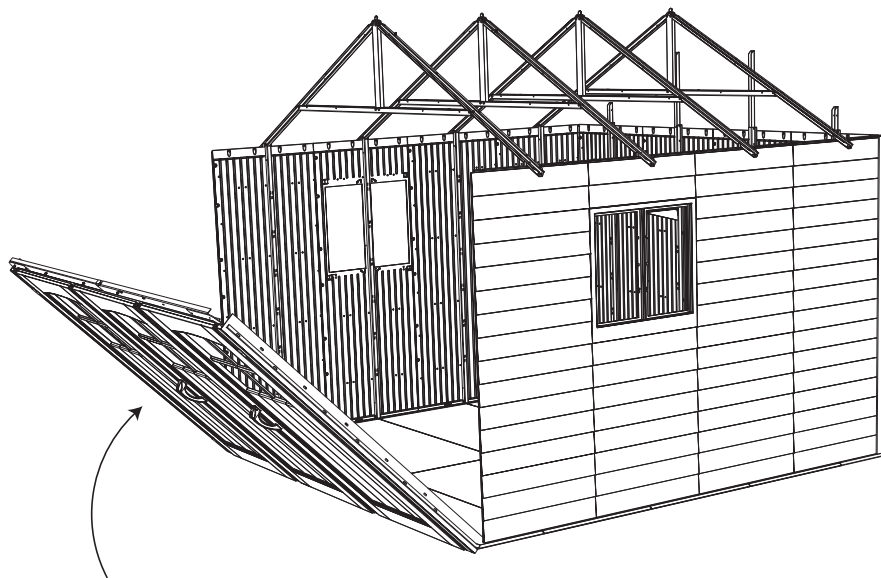

SEC

10.20

There are two columns of holes along the Corner Frames. Align the column of five (5) holes (Column 2) in the right Corner Frame with those near the end of the Wall Panel. While at least one adult holds the Door/Frame Assembly in place, connect the right Corner Frame to the Wall Panel using five (5) $1/4" \times 5/8"$ Pan-Head Screws (ADZ).

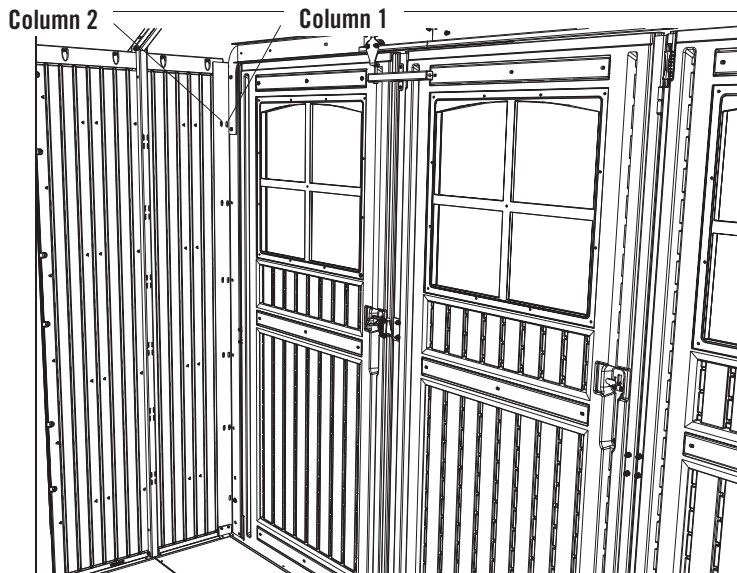

Note: Use the second column of holes in from the Right Door.



TOOLS AND HARDWARE REQUIRED FOR THIS PAGE

SEC 10



7/16"

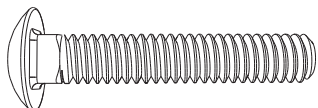

ABU (x2)



ADJ (x2)

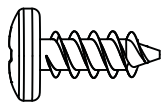

ADZ (x6)

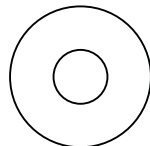

AEB (x2)



SEC

10.21

AT LEAST TWO ADULTS REQUIRED FOR THIS STEP

There are two columns of holes along the Corner Frames. Align the column of six (6) holes (Column 1) in the left Corner Frame with those near the end of the Wall Panel. While at least one adult holds the Door/Frame Assembly in place, connect the left Corner Frame to the Wall Panel using six (6) 1/4" x 5/8" Pan-Head Screws (ADZ).

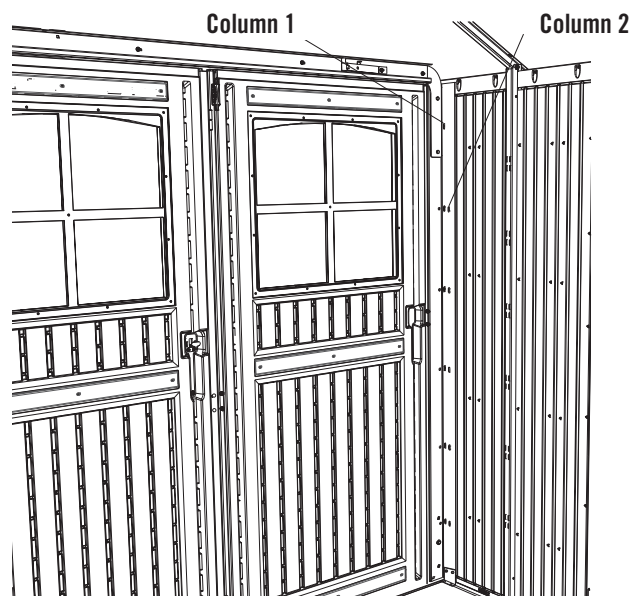

Note: Use the first column of holes in from the Left Door.

SEC

10.22

Align the holes in the Door Hinge End Channel with the notch in the Center Door and secure the Center Door to the Hinge using the required hardware.

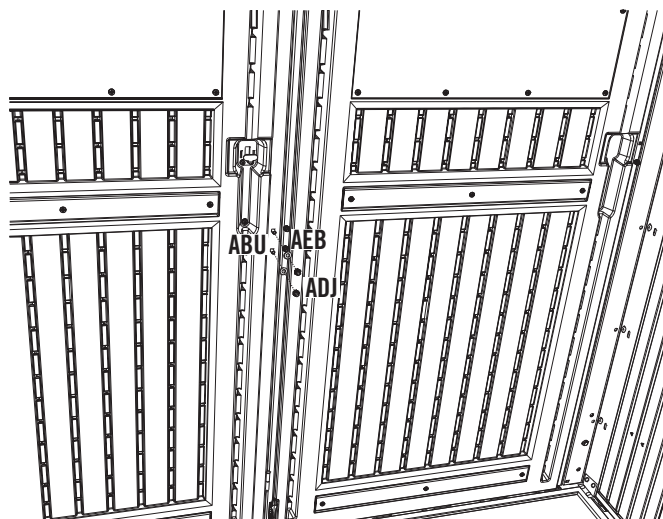



TOOLS AND HARDWARE REQUIRED FOR THIS PAGE

SEC 10

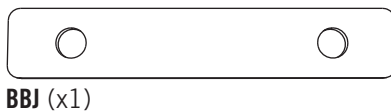
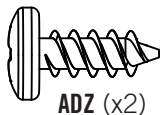
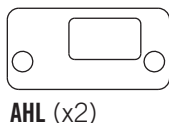
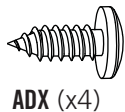

SEC 10.23

Place the two (2) **Dead Bolt Strike Plates (AHL)** in the indentations on the Floor Panels at the locations shown. Orient the Floor Strike Plates so the holes match those in the Floor Panels, and secure with two (2) **#10 x 1/2" Pan-Head Screws (ADX)**. Finally, secure the **4" Floor Strike Plate (BBJ)** at the location shown using two (2) **1/4" x 5/8" Pan-Head Screws (ADZ)**.

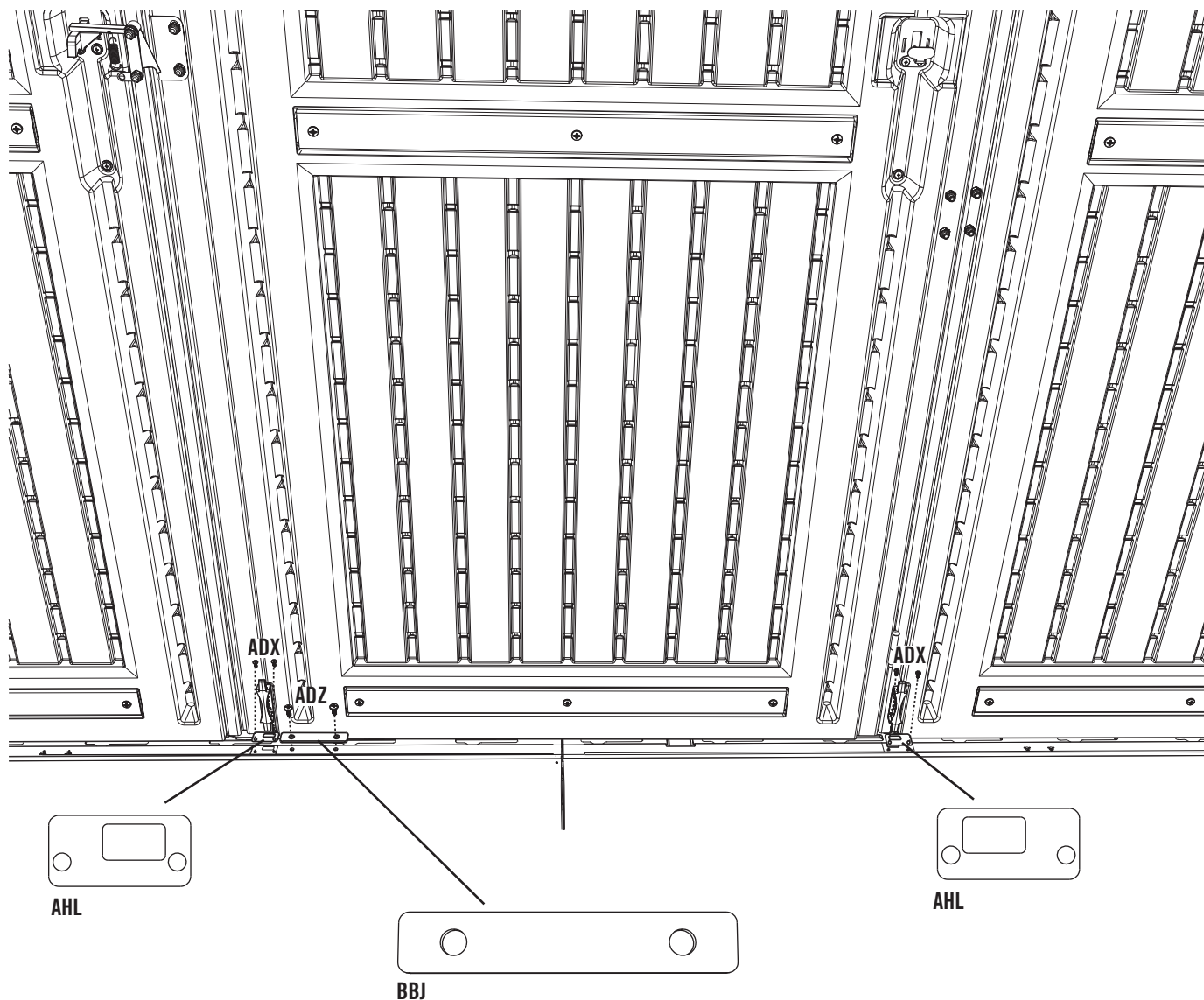

SEC 11 CORNER TRIM INSTALLATION

HARDWARE REQUIRED

HARDWARE BAG REQUIRED: BND

Hardware shown at actual size

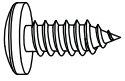

ADX (x34)
#10 x 1/2" Pan-Head Screw

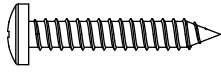

ACK (x4)
#8 x 1" Pan-Head Screw

Hardware shown at 25% of actual size

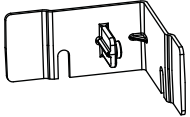

AGA (x12)
Black, Plastic Corner Trim Bracket

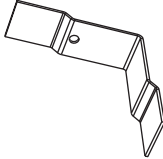

BMH (x10)
Metal Corner Trim Bracket

PLASTIC PARTS REQUIRED

LOCATED IN BOX: 4

Part shown at 8% of actual size

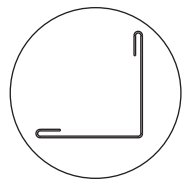
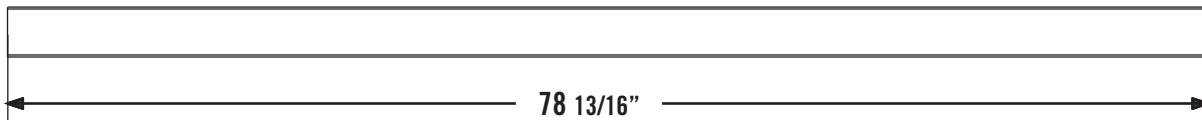

AQX (x4)
Corner Trim

TOOLS REQUIRED



Phillips Screwdriver



Safety Glasses



TOOLS AND HARDWARE REQUIRED FOR THIS PAGE

SEC 11

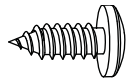

ADX (x10)

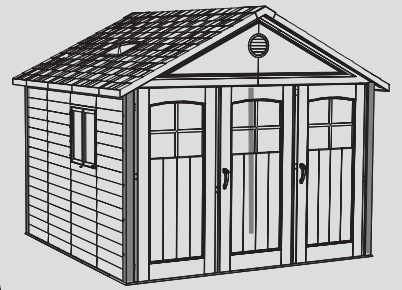

SEC

FRONT CORNER TRIM INSTALLATION

11.1

Using the required hardware, connect five (5) **Metal Corner Trim Brackets (BMH)** to the front corners of your Shed, as shown.

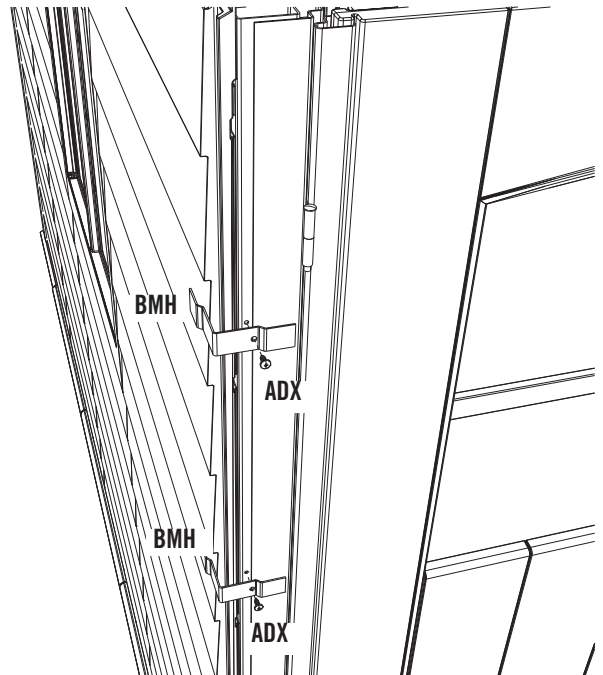

SEC

11.2

Slide a **Corner Trim (AQX)** over the Metal Corner Trim Brackets, as shown.

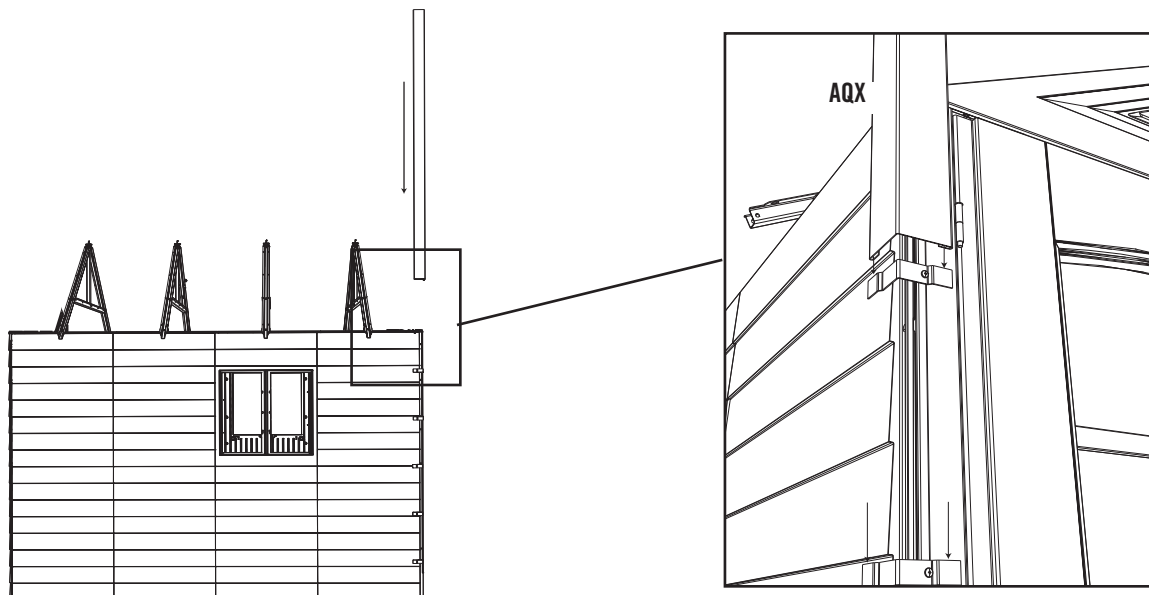



TOOLS AND HARDWARE REQUIRED FOR THIS PAGE

SEC 11

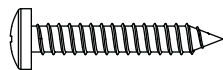

ACK (x2)

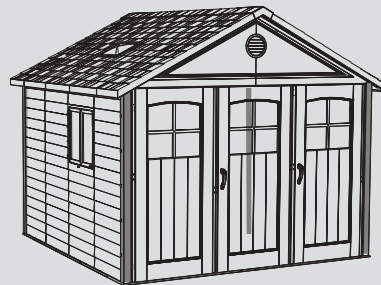

SEC

11.3

Align the top of the Corner Trim with the top of the Wall Wall Panel and fasten with a **#8 x 1" Phillips Pan-Head Screw (ACK)**. Insert the Screw on the side of the Shed to hide it under the eaves. **Repeat steps 11.1 - 11.3 for the second Front Corner Trim.**

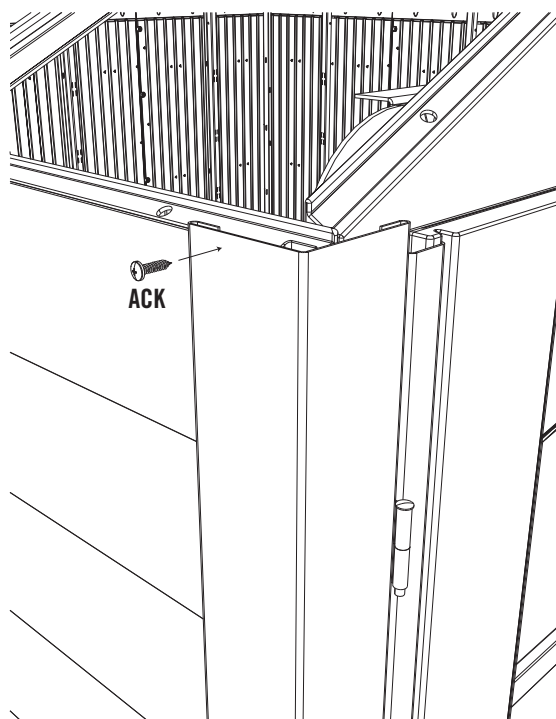



TOOLS AND HARDWARE REQUIRED FOR THIS PAGE

SEC 11

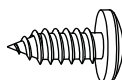

ADX (x24)

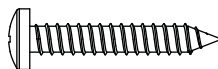

ACK (x2)



SEC

11.4

REAR CORNER TRIM INSTALLATION

Snap six (6) **Plastic Corner Trim Brackets (AGA)** to a rear corner of the Shed. Fasten each Bracket with two (2) **#10 x 1/2" Phillips Pan-Head Screws (ADX)**.

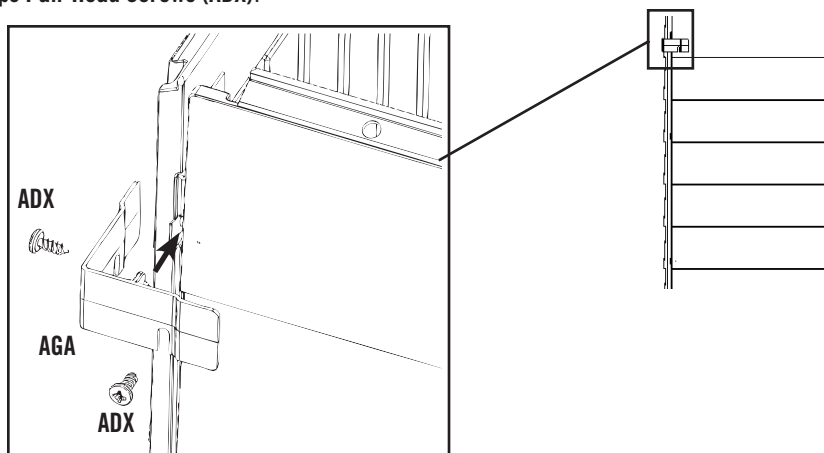

Note: The tab on the Trim Brackets fit into the six screw indentations along each corner of the Shed.

SEC

11.5

Slide a **Corner Trim (AQX)** onto the Plastic Corner Trim Brackets. Align the top of the Corner Trim with the top of the Wall Panel and fasten with a **#8 Phillips Pan-Head Screw (ACK)**. Insert the Screw on the side of the Shed to hide it under the eaves. **Repeat steps 11.4 - 11.5 for the second Rear Corner Trim.**

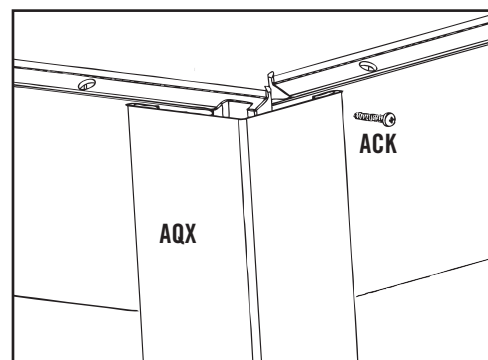
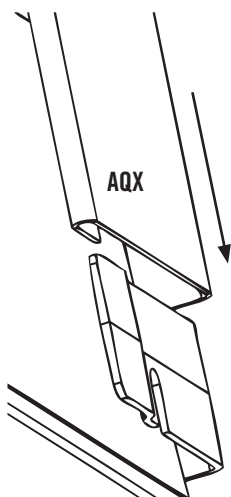

WARNING

Use extreme caution when standing on ladders to perform assembly steps. Follow all warnings and cautions on the ladder. Failure to follow all of these instructions and warnings could lead to serious personal injury or property damage.

SEC 12 DOMED SKYLIGHT ASSEMBLY

HARDWARE REQUIRED

HARDWARE BAG REQUIRED: BEC

Hardware shown at actual size (*Unless noted otherwise)

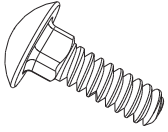

ACR (x24)
#10 x 5/8" Carriage Bolt



ADK (24)
#10 Cap Nut

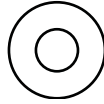

AEE (24)
#10 x 1/2" Flat Washer



***AHI** (x2)
Butyl Tape

PLASTIC PARTS REQUIRED

LOCATED IN BOXES: 2, 3

Part shown at 4% of actual size

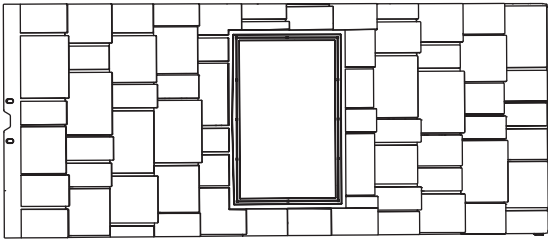

AHB (x2)
Roof Panel for Domed Skylight

Part shown at 8% of actual size

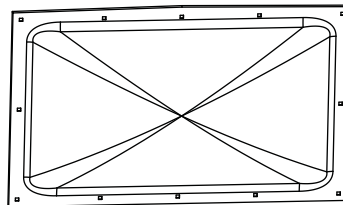

AGB (x2)
Domed Skylight

TOOLS REQUIRED



Phillips Screwdriver



3/8" Wrench



Safety Glasses



TOOLS AND HARDWARE REQUIRED FOR THIS PAGE

SEC 12



AHI (x2)
(Not to scale)



SEC

DOMED SKYLIGHT ASSEMBLY

12.1

Use a plain screwdriver to gently remove any excess plastic from the twelve holes in the **Roof Panel for Domed Skylight (AHB)**. It's important that the hole stay square; try not to round the corners of the edges of the holes. Stick the end of the **Butyl Tape (AHI)** over the groove and top, left hole of the Roof Panel for Domed Skylight as indicated below. Move to the right and over the groove covering all the holes along the top of the opening. Once the top, right corner and hole are covered, cut the Butyl Tape. Run your finger along the paper backing pressing down slightly to remove any gaps or bubbles between the Butyl Tape and the groove. Remove the paper backing from the piece of Butyl Tape you just applied. Overlap the end of the roll of Butyl Tape with the end you just cut and apply the Butyl Tape over the holes along the groove on the right of the opening. Continue applying the Butyl Tape in this fashion until all holes have been covered and the ends overlap.

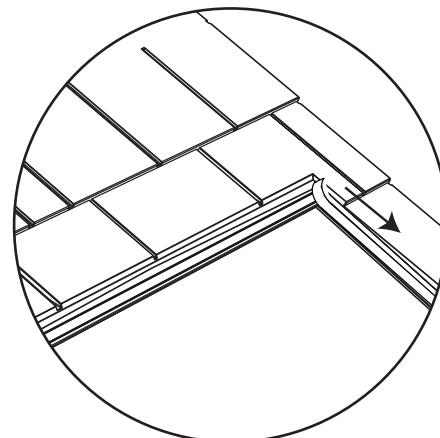
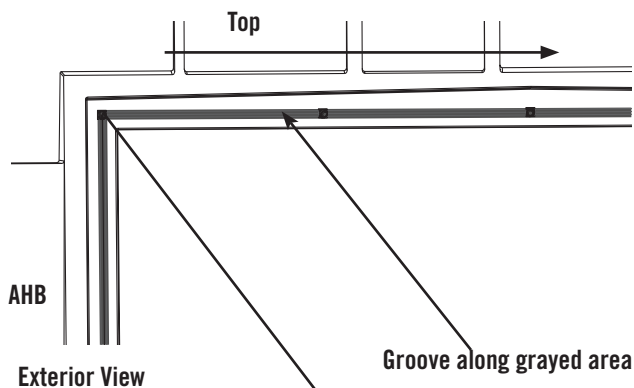

Note: Use a screwdriver to remove any excess plastic from all holes in Panel.



Note: Butyl Tape must cover all twelve holes.

SEC

12.2

Remove the protective plastic film from **both** sides of the **Domed Skylight (AGB)**. Carefully align the holes in the Domed Skylight with those in the Butyl Tape. Set the Domed Skylight over the opening in the Roof Panel for Domed Skylight. Press down and verify there are no gaps or bubbles between the Butyl Tape and the Domed Skylight.

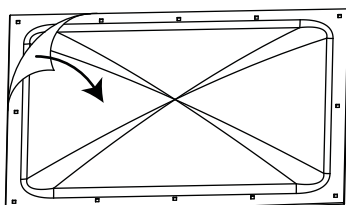

AGB (x2)

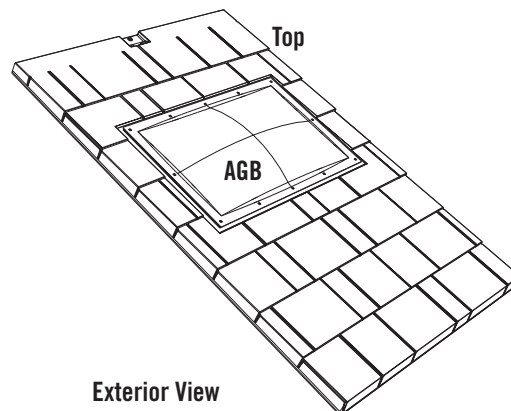



TOOLS AND HARDWARE REQUIRED FOR THIS PAGE

SEC 12



3/8"

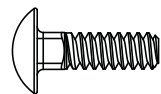

ACR (x24)



ADK (x24)

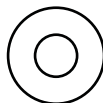

AEE (x24)



SEC

12.3

Insert one (1) #10 x 5/8" **Carriage Bolt (ACR)** through each hole in the Domed Skylight. Press the Bolt through the Butyl Tape and through the Roof Panel for Domed Skylight.

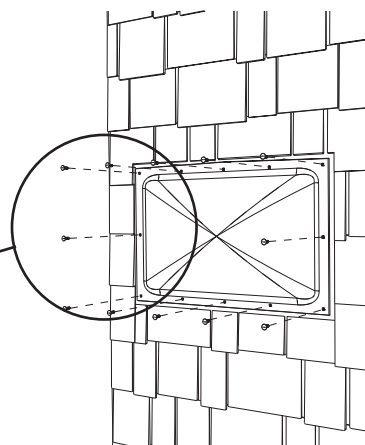
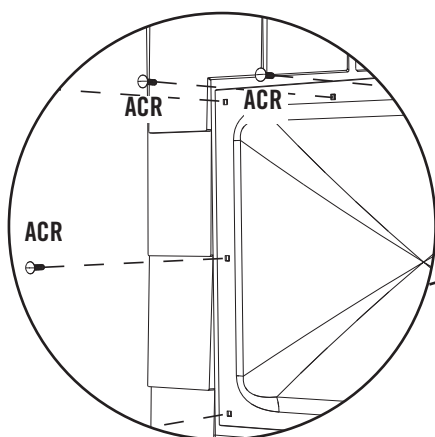

Exterior View

SEC

12.4

Secure the Domed Skylight to the Roof Panel with one (1) #10 Flat Washer (**AEE**) and one (1) #10 Cap Nut (**ADK**) for each Carriage Bolt. Set Skylight/Panel Assembly aside.

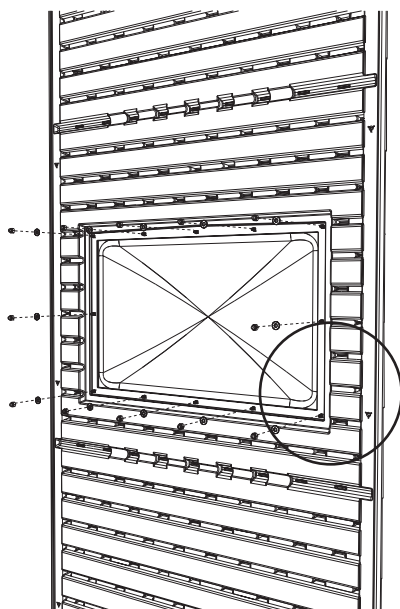

Interior View

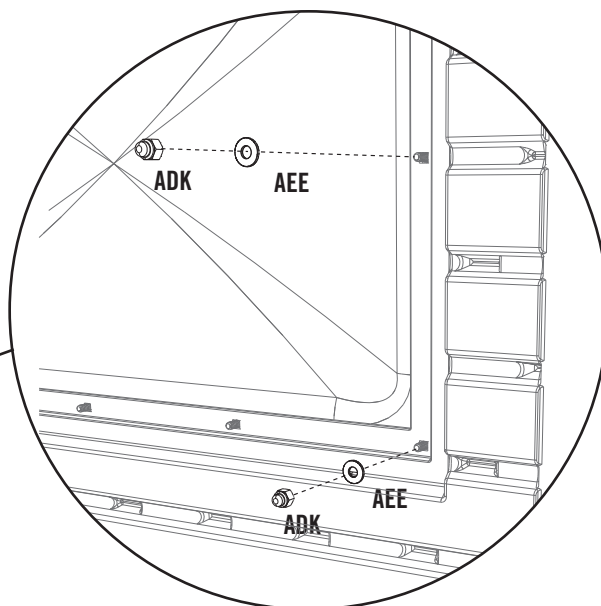

 **WARNING**
Do not overtighten the Cap Nut. If the end of the Bolt breaks through the plastic cap, call our Customer Service Department. Exposed threads on the end of the Bolt may cause serious injuries.

SEC 13 GABLE INSTALLATION

HARDWARE REQUIRED

HARDWARE BAG REQUIRED: BMZ

Hardware shown at actual size

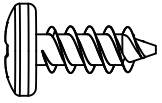

ADZ (x38)
1/4" x 5/8" Phillips Pan-Head Screw

PLASTIC PARTS REQUIRED

FROM SECTION: 6

Parts shown at 4% of actual size

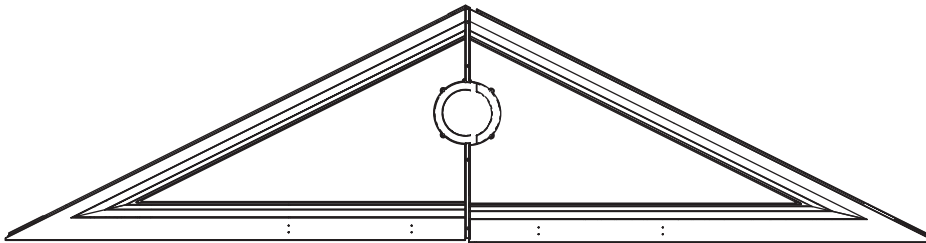

Front Gable Assembly
(Assembled earlier)

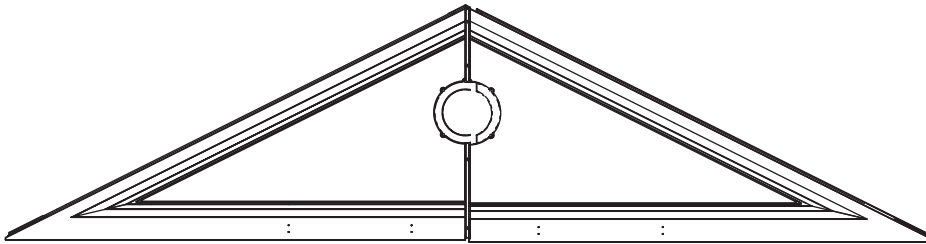

Rear Gable Assembly
(Assembled earlier)

TOOLS REQUIRED



Phillips Screwdriver



Safety Glasses



TOOLS AND HARDWARE REQUIRED FOR THIS PAGE

SEC 13

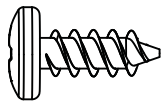

ADZ (x26)



SEC

13.1

REAR GABLE INSTALLATION

Secure the Rear Gable to the rear Wall and Vertical Extension Channels using twenty-two (22) 1/4" x 5/8" Phillips Pan-Head Screws (ADZ).



Note: Tighten the Screws on the Vertical Extension Channels after the Gable is installed.

SEC

13.2

FRONT GABLE INSTALLATION

Secure the Front Gable to the top of the Door Frame as shown, and secure with four (4) 1/4" x 5/8" Phillips Pan-Head Screws (ADZ) at the locations shown.

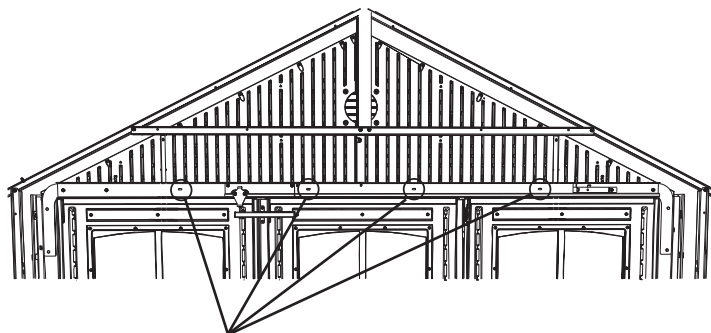
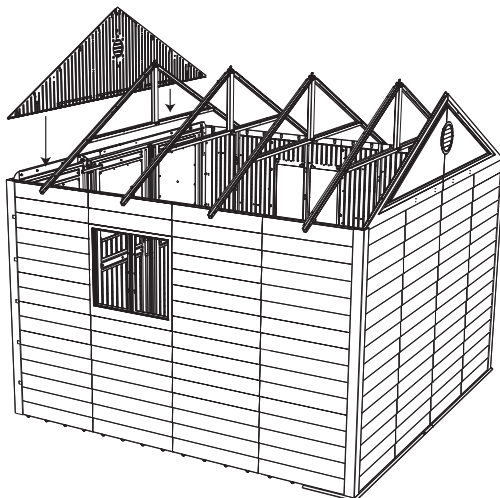

Secure Front Gable to the top of the door frame at these locations.

SEC 14 GABLE BRACE & ROOF INSTALLATION

HARDWARE REQUIRED

HARDWARE BAG REQUIRED: BNH

Hardware shown at actual size (*Unless otherwise noted)

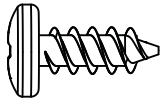

ADZ (x185) 1/4" x 5/8" Pan-Head Screw
(Not all are used)

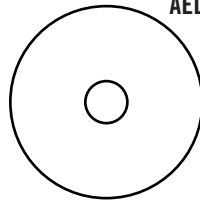

AED (x12) #10 x 1" Fender Washer

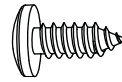

ADX (4)
#10 x 1/2" Pan-Head Screw



ADK (x1)
#10 Cap Nut

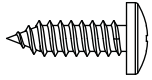

ACJ (x12) #10 x 5/8" Pan-Head Screw



AJA (20)* Foam Cube



ACF (x1) #10 x 5/16" Pan-Head Screw

METAL PARTS REQUIRED

LOCATED IN BOXES 1, 2, 3

Parts shown at 8% of actual size

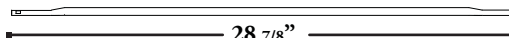

AFL (x20) Roof Support Strip

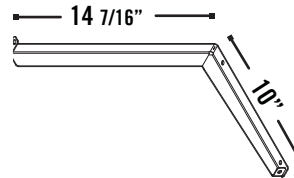

AFF (x2)
Gable Truss Brace

PLASTIC PARTS REQUIRED

LOCATED IN BOXES: 1, 2, 3 AND PARTS & HARDWARE BOX: BNO

Parts shown at 4% of actual size (*Unless otherwise noted)

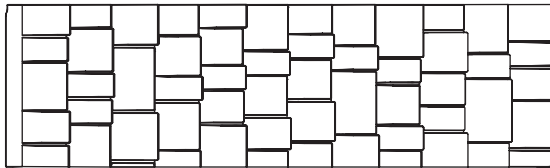

AGU (x2) Outer Roof Panel A

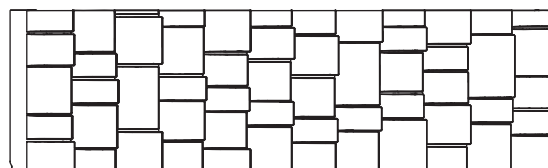

AGV (x2) Outer Roof Panel B

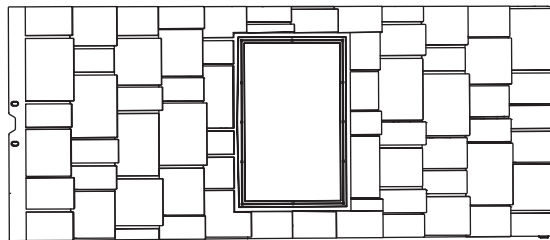

AGY (x3)* Center Roof Cap

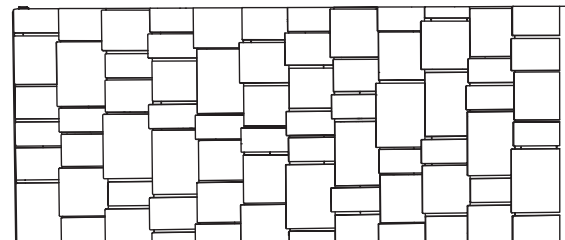

AGQ (x4) Center Roof Panel

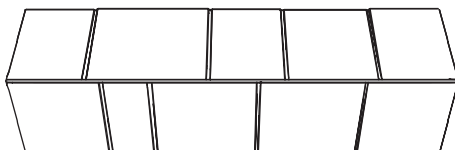

AFY (x3)* Center Roof Cap

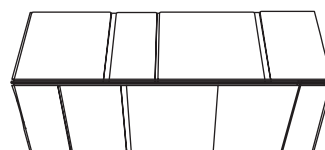

AGE (x2)* End Roof Cap

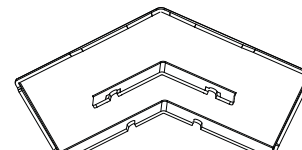

AHA (x2)* Roof Cap Cover

TOOLS REQUIRED



Phillips Screwdriver



Safety Glasses



TOOLS AND HARDWARE REQUIRED FOR THIS PAGE

SEC 14

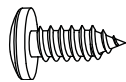

ADX (x4)

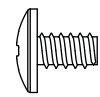

ACF (x1)



ADK (x1)

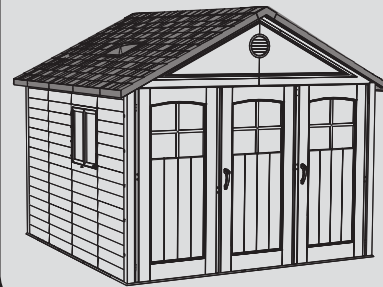

SEC

14.1

GABLE BRACE INSTALLATION

Install the **Gable Truss Brace (AFF)** between the end Truss and the Rear Gable. You will need to remove the **1/4" x 1 1/2" Hex Bolts (AAK)** and the **1/4" NKE Cap Nuts (ADJ)** from the bottom of the Truss Assembly, and then reattach to the Gable Truss Brace. Connect the Brace directly to the Gable with two (2) **#10 x 1/2" Pan-Head Screws (ADX)**. Repeat this step for the Front Gable, connecting the Gable Brace to the center of the top of the Door Header Channel with one (1) **#10 x 5/16" Pan-Head Screw (ACF)** and one (1) **#10 Cap Nut (ADK)**. You may need to slightly adjust the Gable Truss Brace.

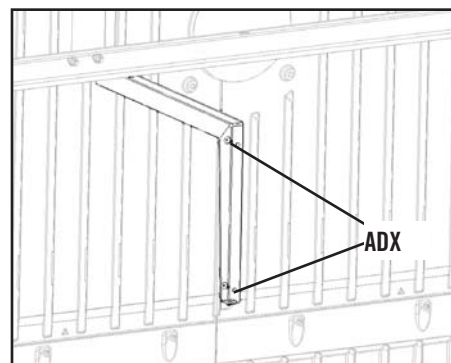
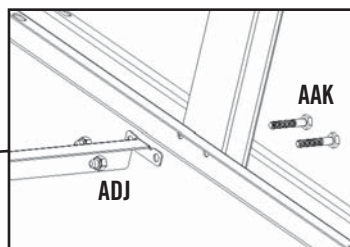
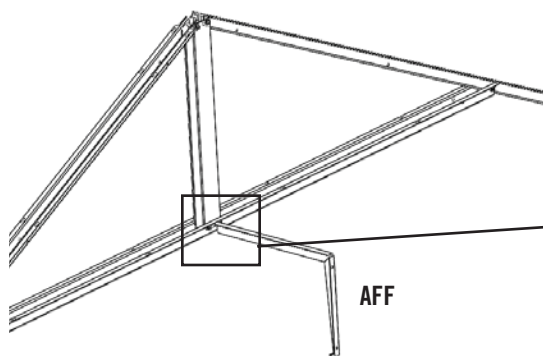

Rear Gable

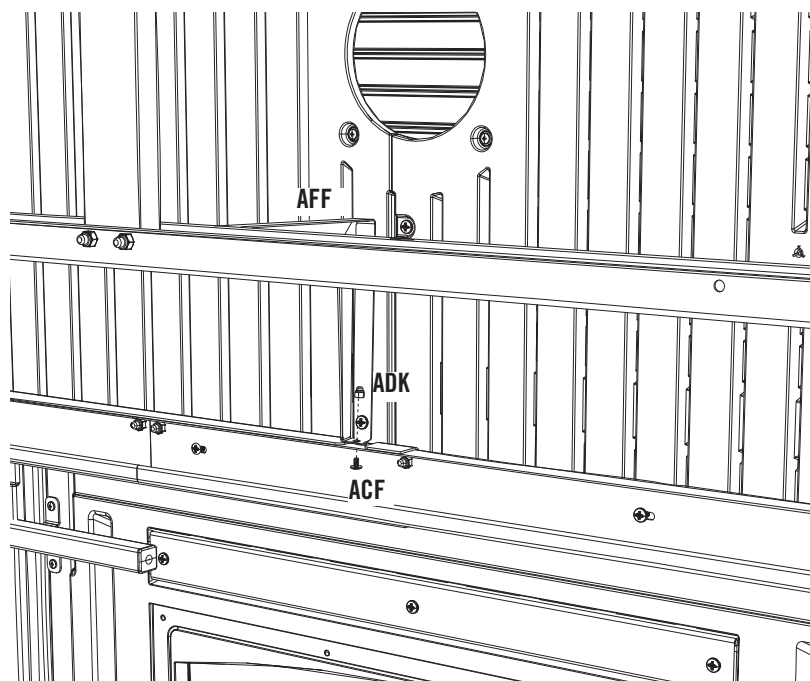

Front Gable



WARNING

Do not overtighten the Cap Nut.

! Note: There are no pilot holes in the Gable to receive the Screws (ADX). Insert them directly into the plastic.



TOOLS AND HARDWARE REQUIRED FOR THIS PAGE

SEC 14

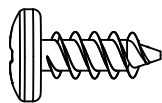

ADZ (x24)

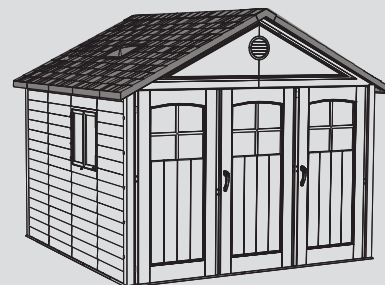

SEC

14.2

ROOF ASSEMBLY

Install **Outer Roof Panels A & B (AGU & AGV)** at the front of the Shed. Always start inserting the **1/4" x 5/8" Phillips Pan-Head Screws (ADZ)** at the top of the Roof Panel.

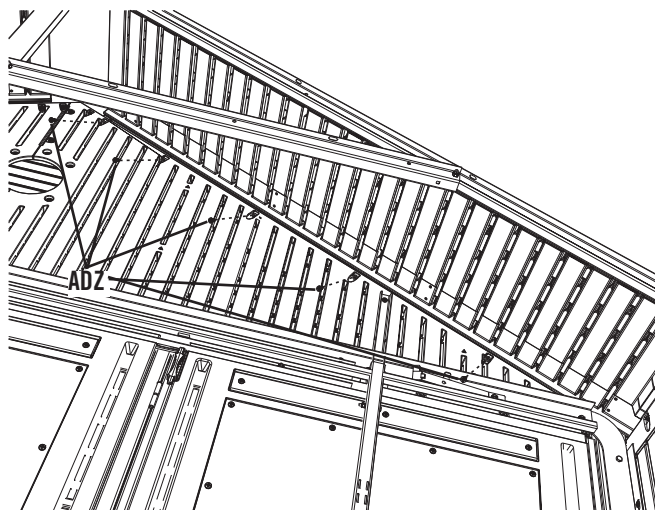
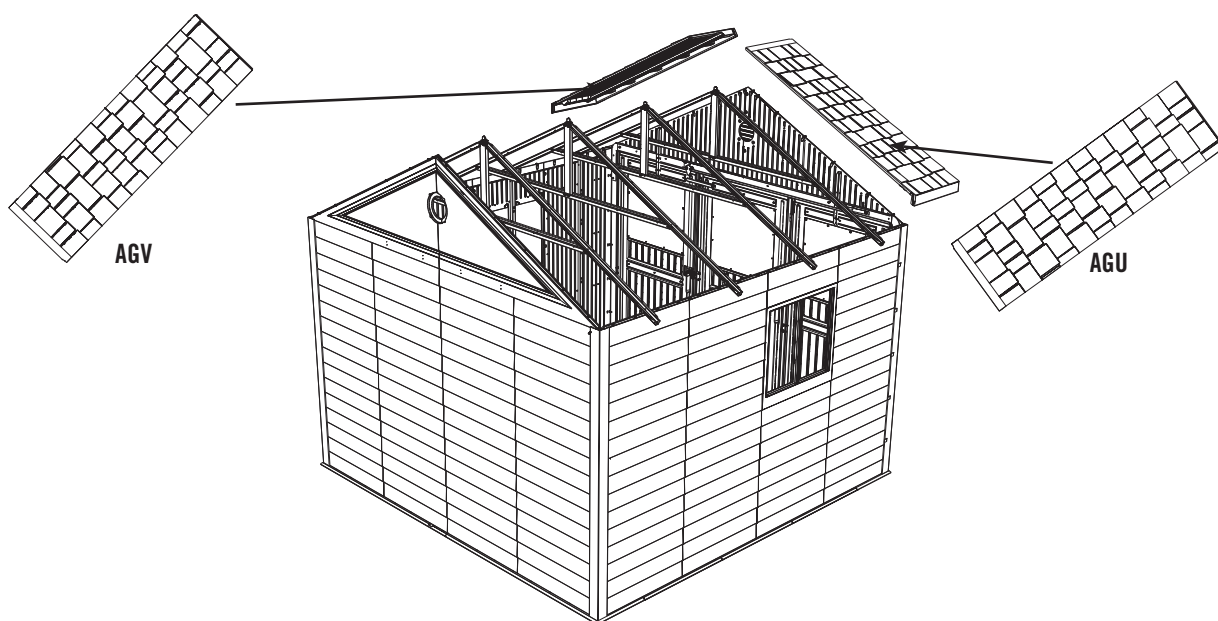

Note: This is an interior upward view.

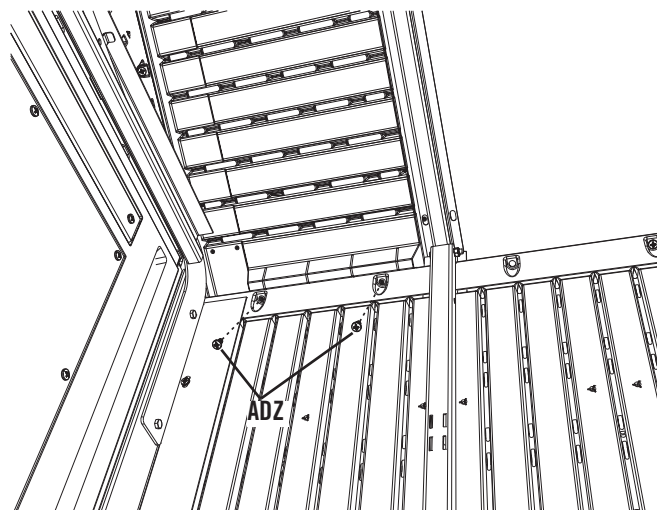

Note: This is an interior upward view.



TOOLS AND HARDWARE REQUIRED FOR THIS PAGE

SEC 14

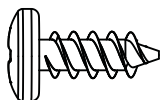

ADZ (x24)

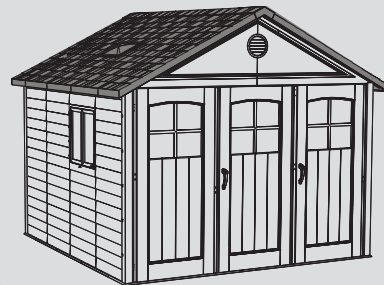

SEC

14.3

Install two (2) **Inner Roof Panels (AGQ)** and four (4) **Roof Support Strips (AFL)** to the Shed as shown. **Roof Panels for Skylights (AHB)** can be inserted into any of the center Roof Panel sections.

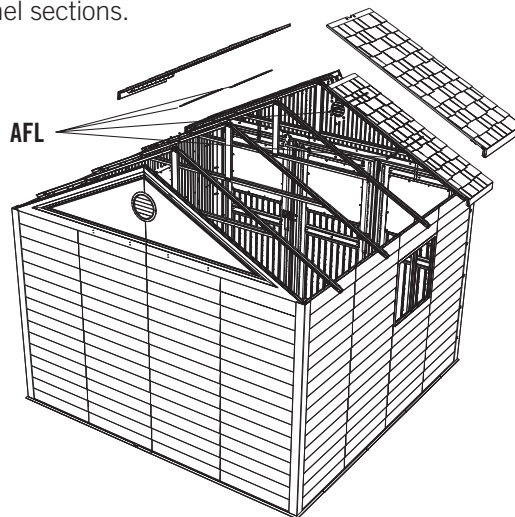

Note: This section applies to the two types of Roof Panels: Inner Roof Panel (AGQ) and Roof Panel for Domed Skylight (AHB).

Fit three **Roof Support Strips (AFL)** (dark gray) into the slots (light gray) in the Center Roof Panels and Roof Panels for Domed Skylight as you put them in place.

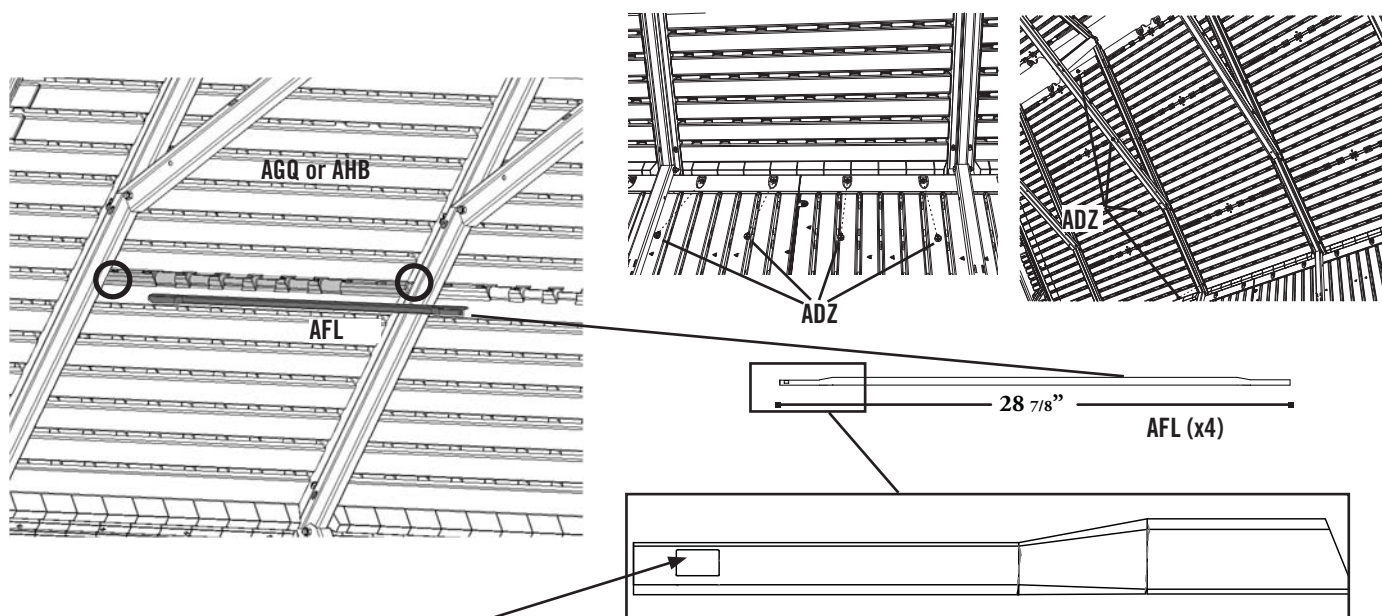

Note: The holes in the Roof Support Strips are for manufacturing purposes only.



TOOLS AND HARDWARE REQUIRED FOR THIS PAGE

SEC 14

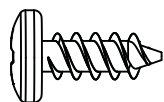

ADZ (x72)

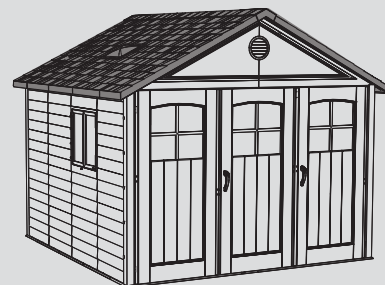

SEC

14.4

Attach two (2) **Roof Panels for Skylights (AHB)** and six (6) **Roof Support Strips (AFL)** using the required hardware.

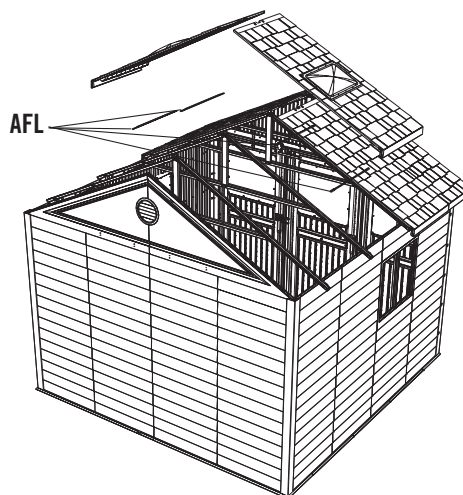

SEC

14.5

Position the **Outer Roof Panel A (AGU)** and secure to Gable. Repeat on the other side with **Outer Roof Panel B (AGV)**.



Note: Only use a hand screwdriver on this step.

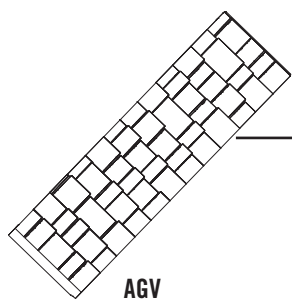

AGV

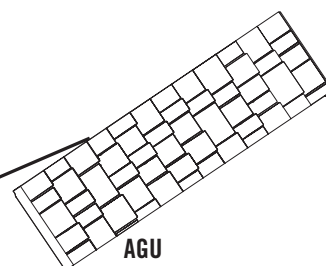
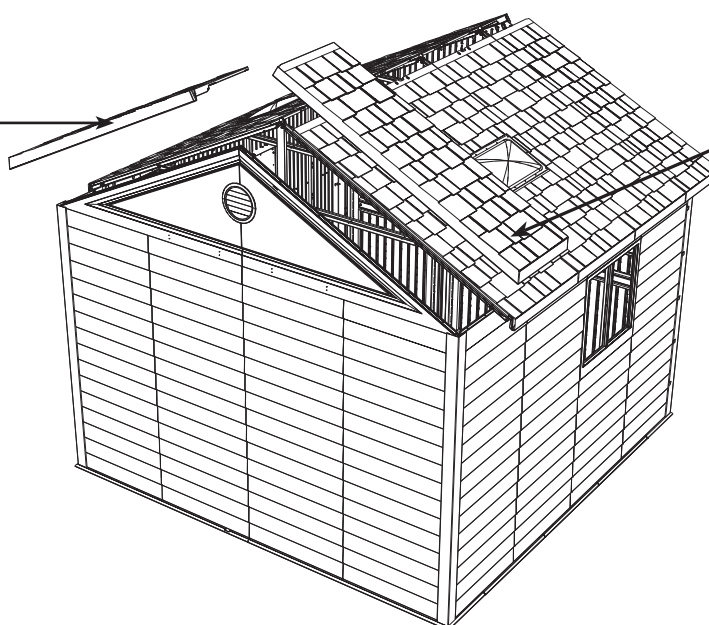

AGU





TOOLS AND HARDWARE REQUIRED FOR THIS PAGE

SEC 14

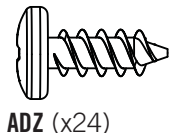

ADZ (x24)

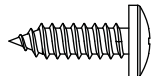

ACJ (x12)

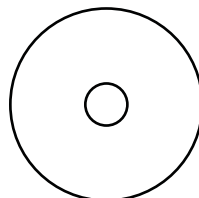

AED (x12)

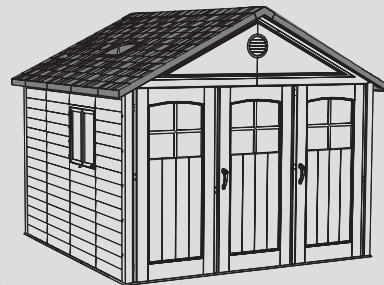

SEC

14.6

Connect the **End Roof Caps (AGE)** and **Center Roof Caps (AFY)** to the Roof and Gables using the required hardware.

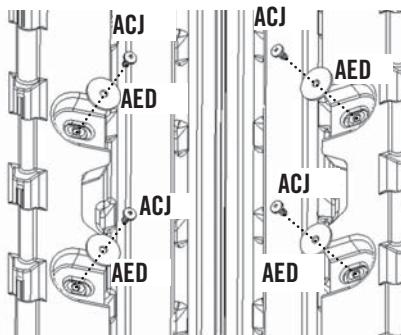
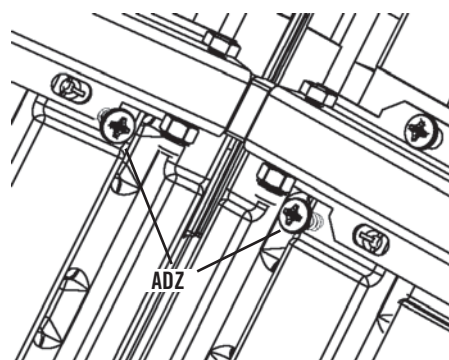
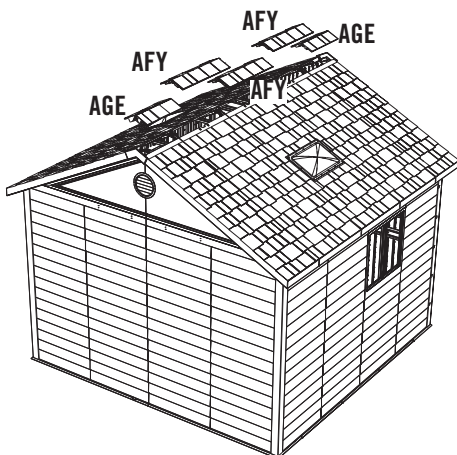



TOOLS AND HARDWARE REQUIRED FOR THIS PAGE

SEC 14



AJA (x20)

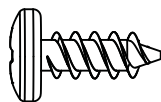

ADZ (x20)



SEC

14.7

Install a **Roof Cap Cover (AHA)** at the front and rear of the Shed using two (2) **1/4" x 5/8" Phillips Pan-Head Screws (ADZ)** for each Roof Cap Cover.

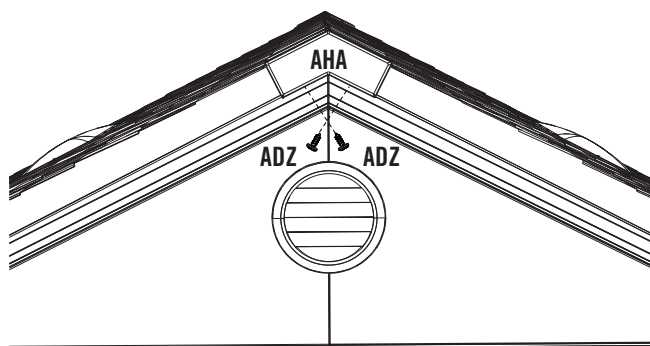
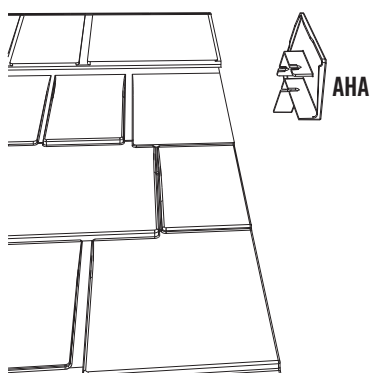

SEC

14.8

Along the outside edges of the Shed, fasten the Channels to the underside of the Roof Panels (Fig. 1). Insert two **Foam Cubes (AJA)** at each Channel location (Fig. 2).

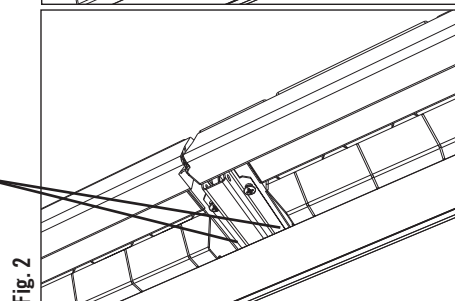
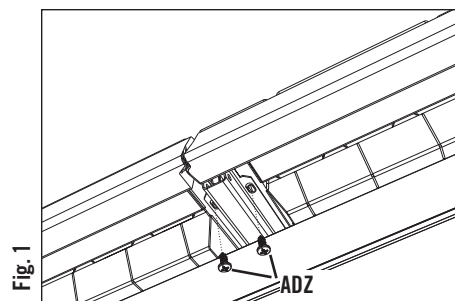
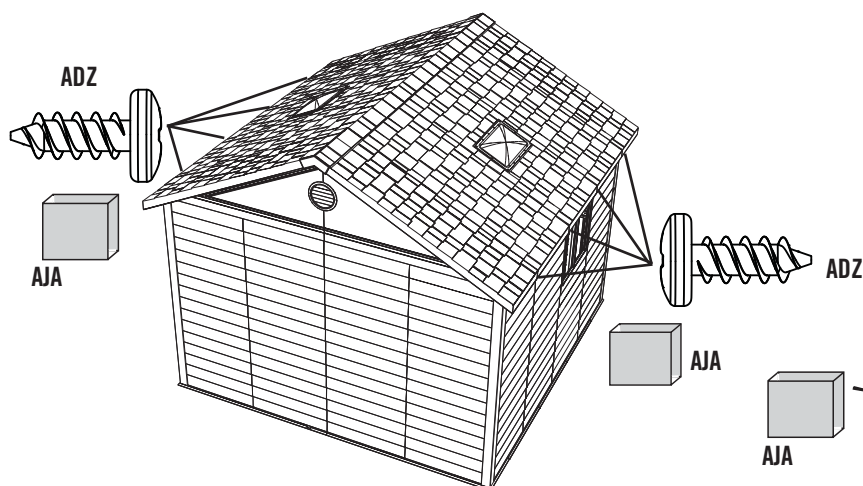

! *Note: Snow Load Kits are available from Customer Service for high snow areas (see back cover).*



CAUTION

If more than six (6) inches of snow accumulate on the roof of the shed, carefully remove the snow to avoid possible roof collapse. While standing on the ground, remove the snow from the roof with a broom or snow shovel. Do not stand on the roof to remove snow.

SEC 15 WINDOW ASSEMBLY & INSTALLATION

HARDWARE REQUIRED

HARDWARE BAG REQUIRED: BGU (x2)

Hardware shown at actual size

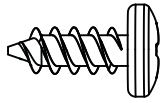

ADZ (x8)
1/4" x 5/8" Pan-Head Screw

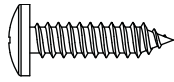

ADW (x8)
#10 x 3/4" Pan-Head Screw

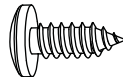

ADX (x44)
#10 x 1/2" Pan-Head Screw

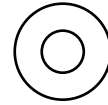

AEE (x4)
#10 x 1/2" Flat Washer



ACF (x4)
#10 x 5/16" Pan-Head Screw

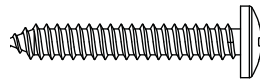

ACB (x8)
#10 x 1 1/4" Pan-Head Screw

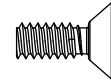

ACD (x4)
#10 x 3/8" Flat-Head Screw



ADK (x4)
#10 Cap Nut

Hardware shown at 25% of actual size

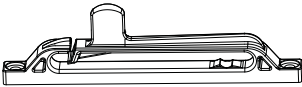

AIE (x4)
Mounted Window Stay



AIN (x4)
Sliding Window Stay

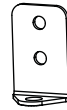

AIV (x4)
Window Stay Bracket

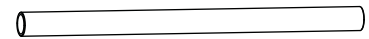

AIR (x8)
Window Hinge Tube

Hardware shown at 50% of actual size

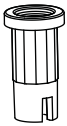

AIU (x8)
Window Latch Bearing

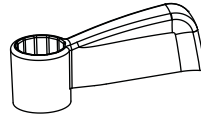

AIT (x8)
Window Latch

PLASTIC PARTS REQUIRED

LOCATED IN BOXES: 2, 3

Parts shown at 8% of actual size

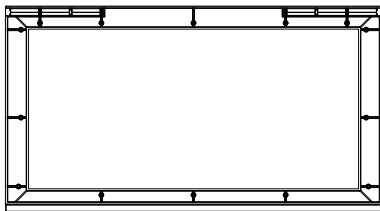

AHG (x4)
Window Frame

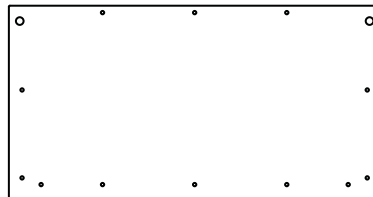

AHF (x4)
Window

TOOLS REQUIRED



Phillips Screwdriver



Safety Glasses



TOOLS AND HARDWARE REQUIRED FOR THIS PAGE

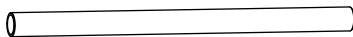

AIR (x4)
(Not to scale)

SEC 15



SEC

15.1

Slide **Window Hinge Tubes (AIR)** into the upper and lower hinge holes and fit a **Window Frame (AHG)** over the Hinge Tubes.

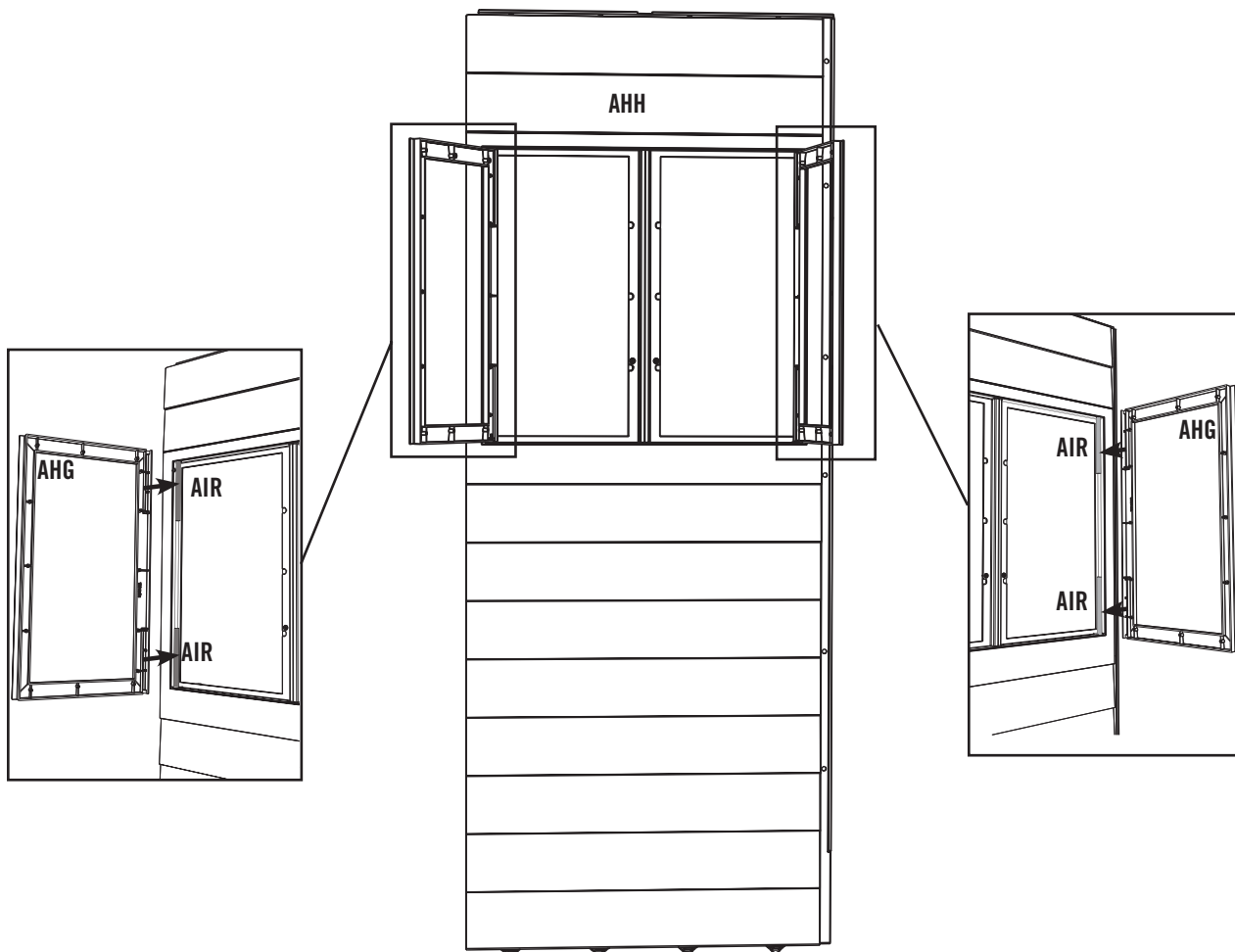



TOOLS AND HARDWARE REQUIRED FOR THIS PAGE

SEC 15

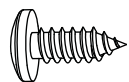

ADX (x20)

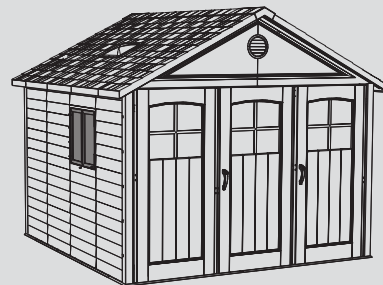

SEC

15.2

Place a **Window (AHF)** onto the Window Frame. Fasten the Window to the Frame with **#10 x 1/2" Pan Head Screws (ADX)** in the locations shown.



Note: Remove plastic film from both sides of window before installing.

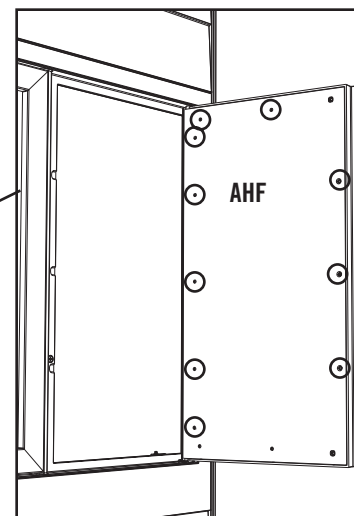
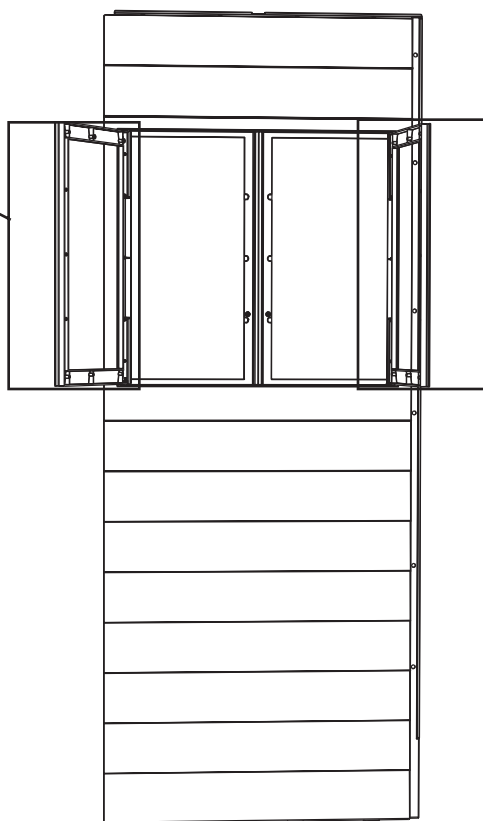
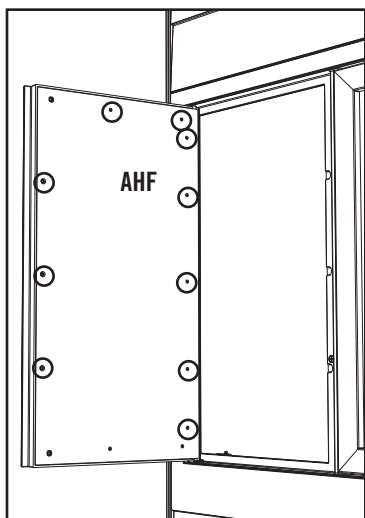
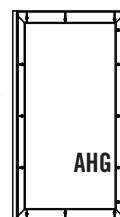
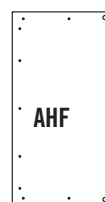

Note: Insert Screws into the holes with circles.



TOOLS AND HARDWARE REQUIRED FOR THIS PAGE

SEC 15

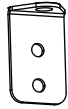

AIV (x2)
(Not to scale)

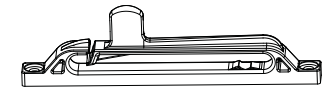

AIE (x2)
(Not to scale)



ADW (x4)

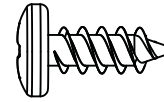

ADZ (x4)

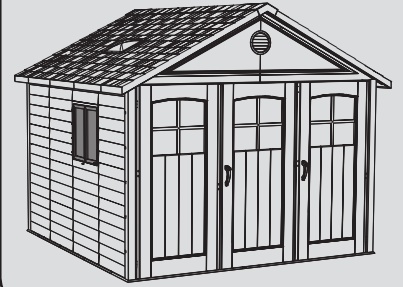

SEC

15.3

Attach **Window Stay Brackets (AIV)** to the inside of the **Window Wall Panel (AHH)**.

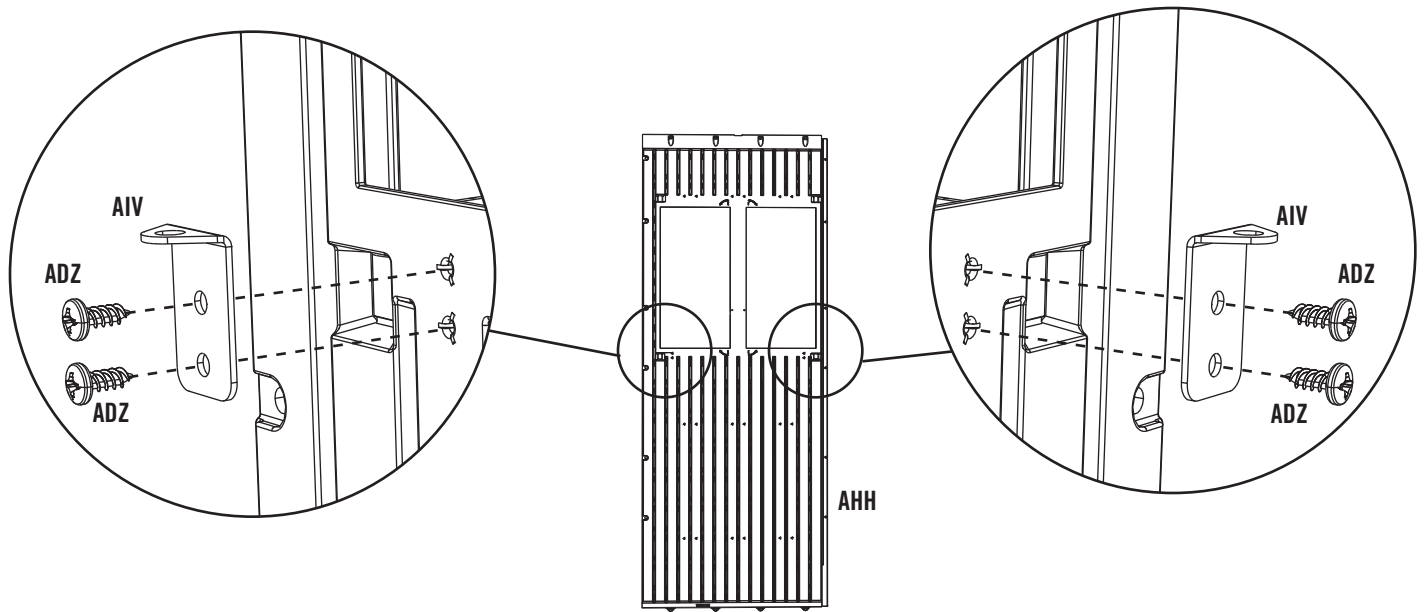

SEC

15.4

Attach a **Mounted Window Stay (AIE)** to the bottom of the Window Frame.

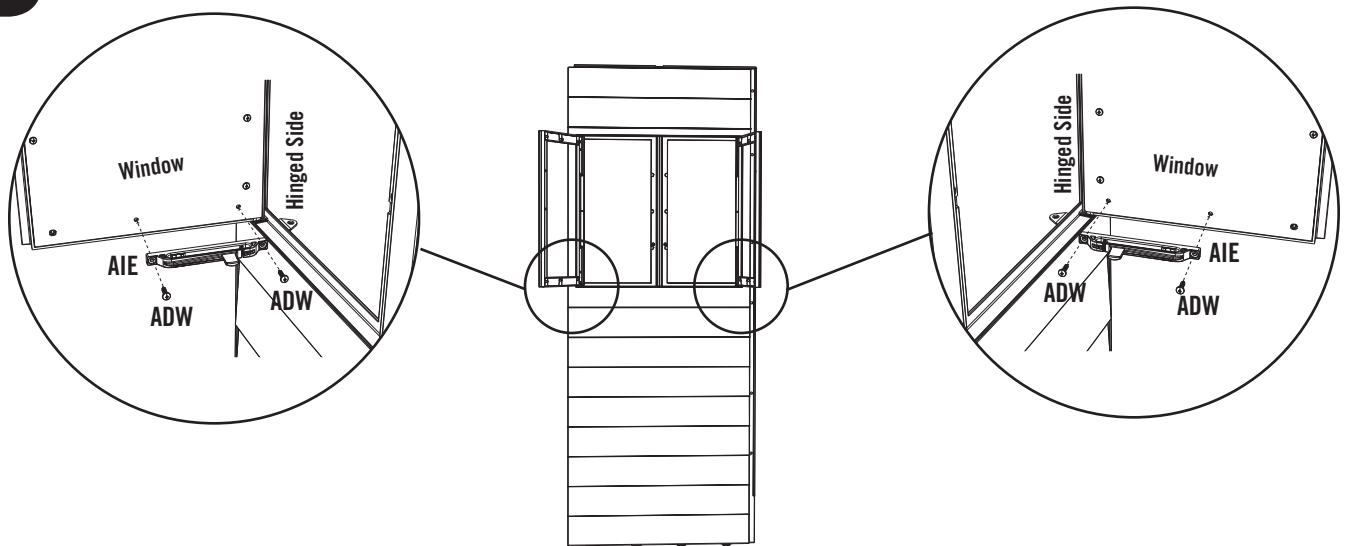



TOOLS AND HARDWARE REQUIRED FOR THIS PAGE

SEC 15

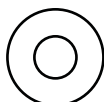

AEE (x2)

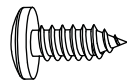

ADX (x2)



AIN (x2)
(Not to scale)



ACF (x2)

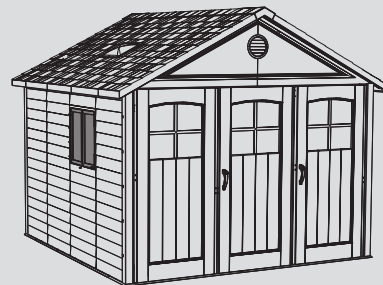

SEC

15.5

Fit a **Sliding Window Stay (AIN)** into the **Mounted Window Stay**. To add rigidity to the nub of the Sliding Window Stays, insert **#10 x 1/2" Pan-Head Screws (ADX)** as shown.

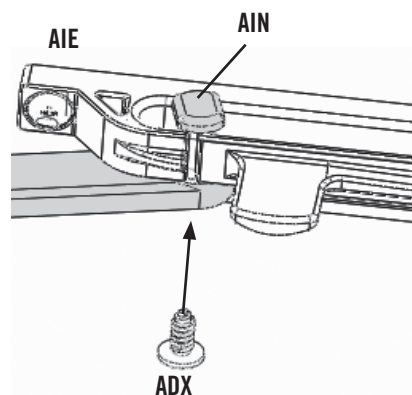
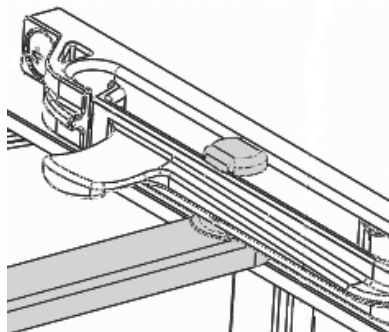
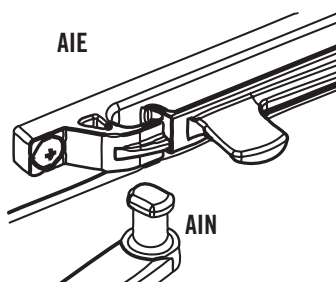

SEC

15.6

Attach a **Sliding Window Stay (AIN)** to the **Window Stay Bracket (AIV)** using the required hardware.

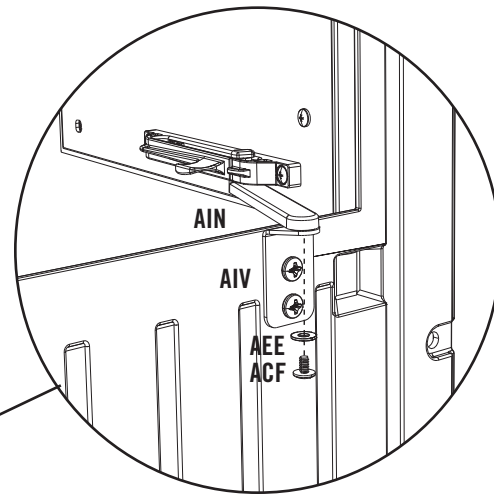
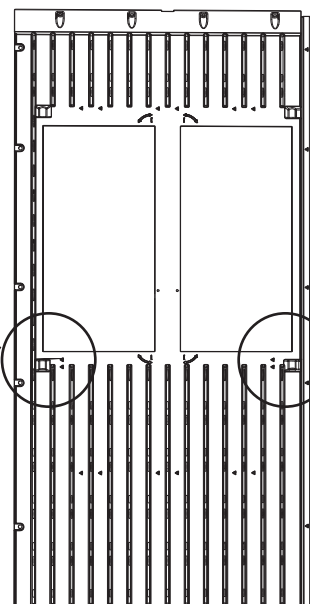
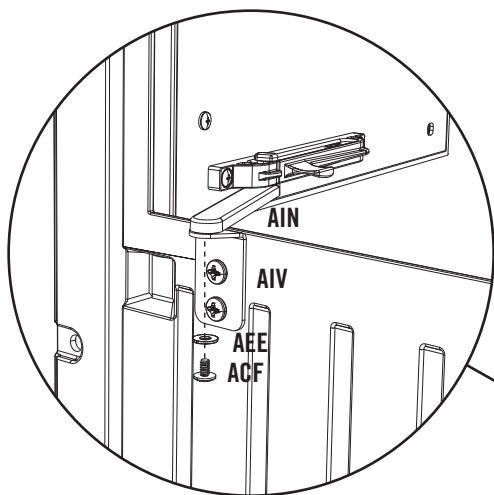



TOOLS AND HARDWARE REQUIRED FOR THIS PAGE

SEC 15

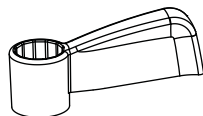

AIT (x4)
(Not to scale)

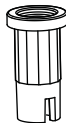

AIU (x4)
(Not to scale)



ACB (x4)

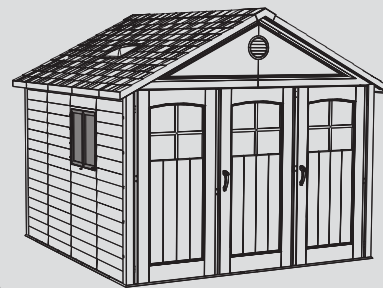

SEC

15.7

Fit a **Window Latch Bearing (AIU)** into a **Window Latch (AIT)**. Attach the Window Latch to the upper latch location with a **#10 x 1 1/4" Pan-Head Screw (ACB)**. Repeat for other Window Latches.



Note: Ensure notch in Window Latch Bearing fits over the plastic ridge in the Window Frame.

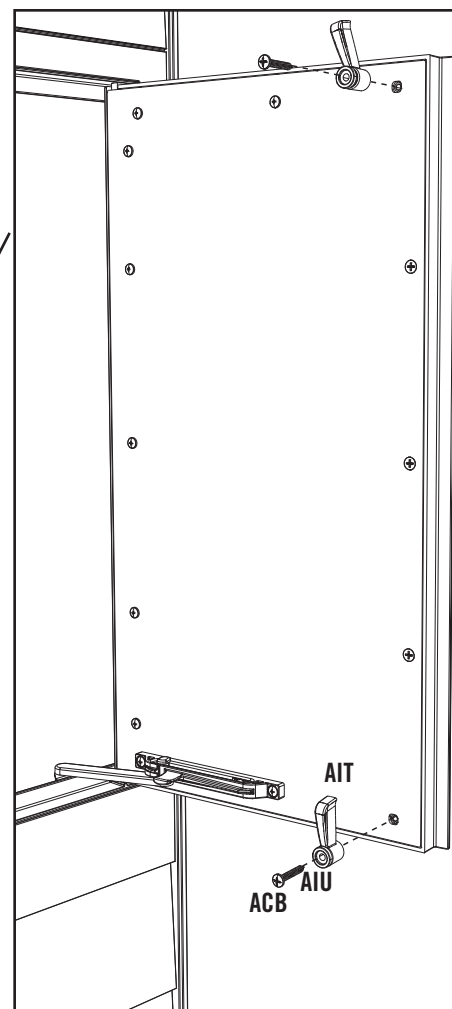
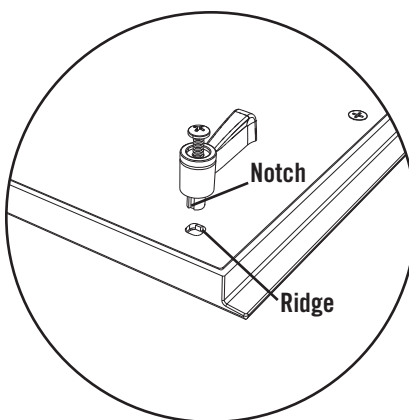
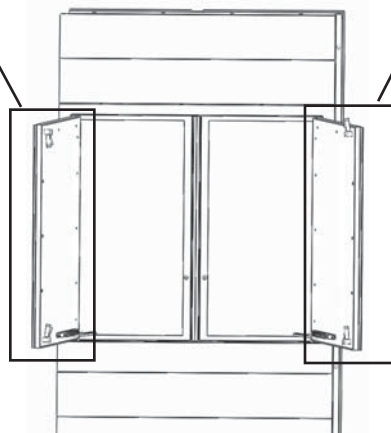
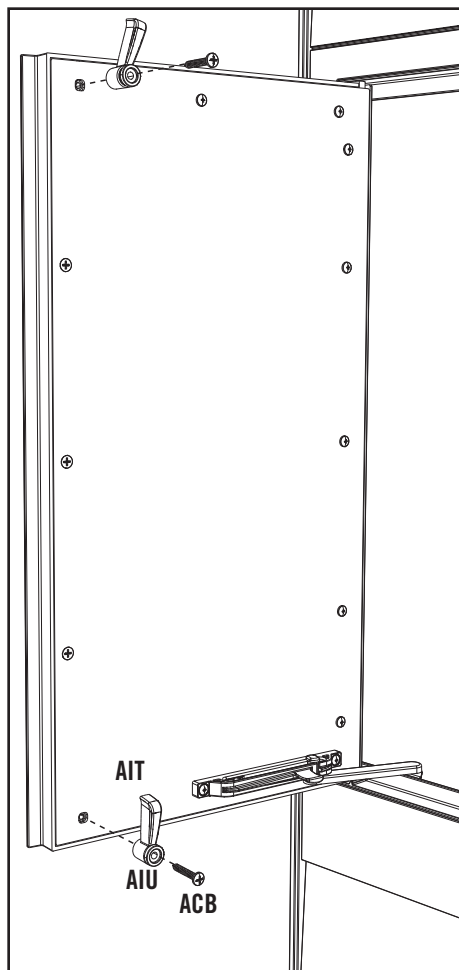

SEC 16 DOOR WINDOW INSTALLATION

HARDWARE REQUIRED

HARDWARE BAG REQUIRED: BNG

Hardware shown at actual size

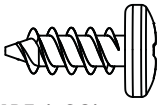

ADZ (x39)
1/4" x 5/8" Pan-Head Screw

PLASTIC PARTS REQUIRED

LOCATED IN BOX: 5

Parts shown at 4% of actual size

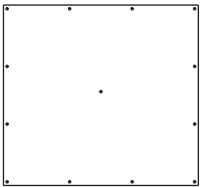

BLO (x3)
Door Window

TOOLS REQUIRED



Phillips Screwdriver



Safety Glasses



TOOLS AND HARDWARE REQUIRED FOR THIS PAGE

SEC 16

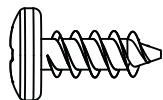

ADZ (x39)

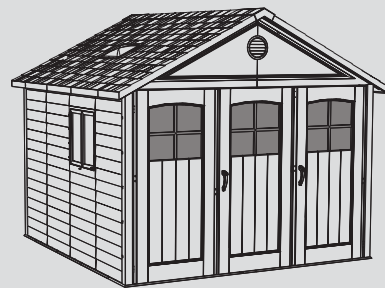

SEC

DOOR WINDOW INSTALLATION

16.1

Connect a **Door Window (BLO)** to each Door using the required hardware.

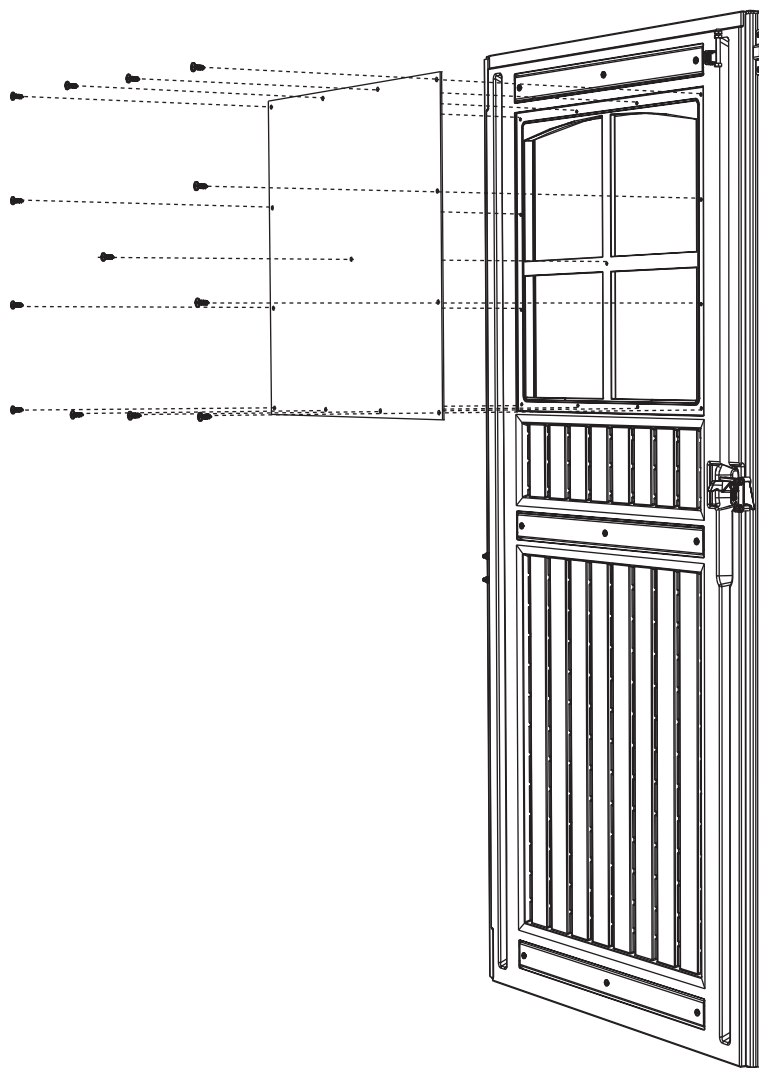

SEC 17 ACCESSORY INSTALLATION

HARDWARE REQUIRED

Hardware shown at actual size

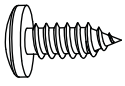

ADX (x8)
#10 x 1/2" Pan-Head Screw

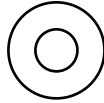

AEE (x8)
#10 Flat Washer

HARDWARE BAGS REQUIRED: BMY, BHC, BHD

Hardware shown at actual size

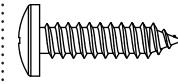

ADW (x10)
#10 x 3/4" Pan-Head Screw

Hardware shown at 50% of actual size

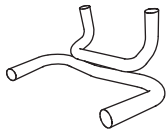

AIJ (x2)
Toolholder

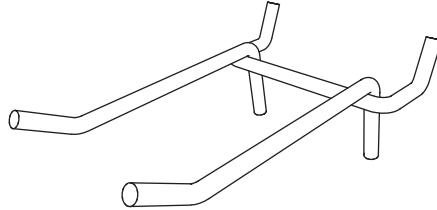

AIF (x1)
2" Double-Arm Hook

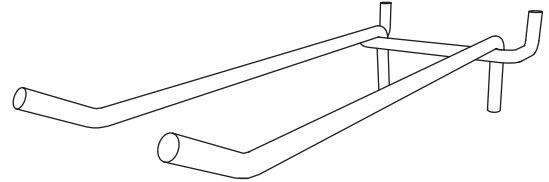

AIG (x1)
4" Double-Arm Hook

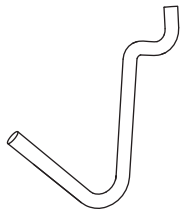

AIH (x3)
J-Hook

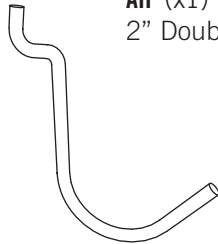

AII (x3)
L-Hook

METAL PARTS REQUIRED

Hardware shown at actual size



AIZ (x4)
Shelf Support for 14" Shelf

LOCATED IN PARTS & HARDWARE BOX: BNO

PLASTIC PARTS REQUIRED

Part shown at 4% of actual size



AFT (x2)
14" x 30" Shelf

Part shown at 15% of actual size

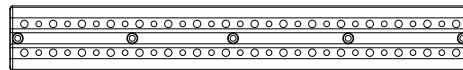

AFU (x1)
Pegboard Strip

LOCATED IN BOX 1 & PARTS & HARDWARE BOX: BNO

TOOLS REQUIRED



Phillips Screwdriver



7/16" Wrench



Safety Glasses



TOOLS AND HARDWARE REQUIRED FOR THIS PAGE

SEC 17

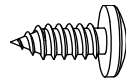

ADX (x8)

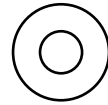

AEE (x8)

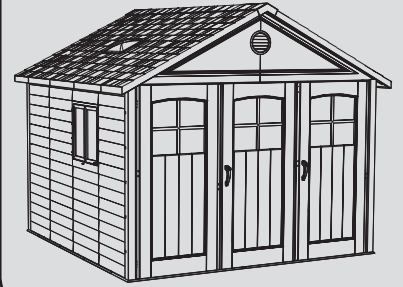

SEC

17.1

14" x 30" SHELF INSTALLATION

Insert **Shelf Brackets (AIZ)** into notches in any Wall Support Channel. Place a **14" x 30" Shelf (AFT)** on the Shelf Brackets and secure with **#10 Flat Washers (AEE)** and **#10 x 1/2" Pan-Head Screws (ADX)**. Repeat this step for the second Shelf.

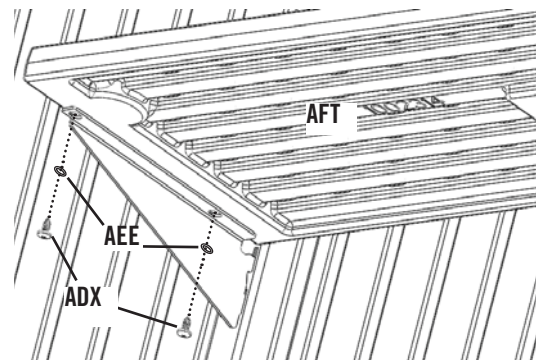
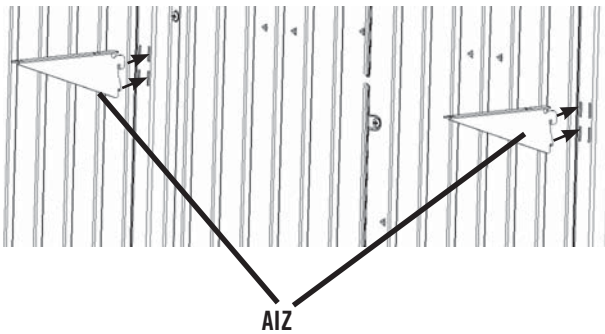

Note: There are no pilot holes on the bottom of the shelf; screws are inserted directly into the plastic.



TOOLS AND HARDWARE REQUIRED FOR THIS PAGE

SEC 17

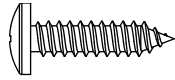

ADW (x10)
(Not all screws are used)

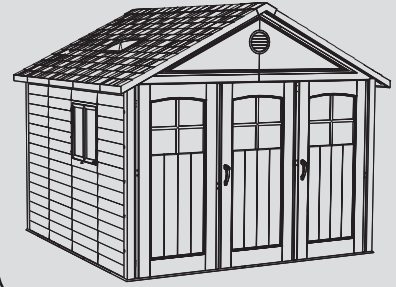

SEC

PEGBOARD STRIP INSTALLATION

17.3

Using a Level, position the **Pegboard Strip (AFU)** in the desired location. Screw the Pegboard Strip to the Wall using five (5) **#10 x 3/4" Phillips Pan-Head Screws (ADW)**. See Note.

! Note: The Pegboard Strip is screwed directly into the plastic. Line up the Strip anywhere on Wall so holes are over plastic (and not over a groove in the Wall).

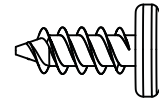
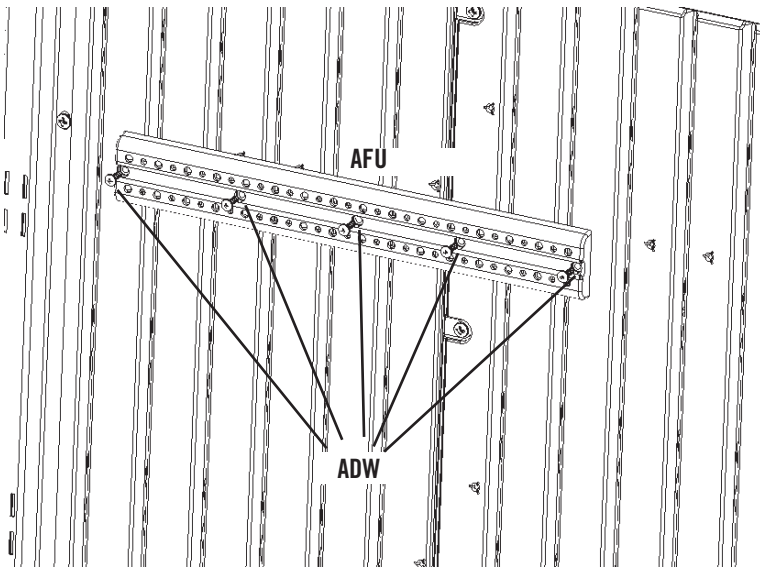

ADZ (x4)

! Note: Ensure the Pegboard Strip is level before inserting Screws.



SEC

17.4

Insert **Hooks (AIF, AIG, AIH, AII, and AIJ)**.

SEC 18 FINAL STEPS

HARDWARE REQUIRED

HARDWARE BAG REQUIRED: BNH

Hardware shown at actual size

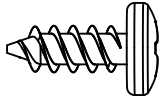

ADZ (x4)
1/4" x 5/8" Pan-Head Screw

CHECK WITH YOUR LOCAL HARDWARE STORE FOR ANCHORING HARDWARE FOR YOUR PLATFORM

TOOLS REQUIRED



5/16" Wrench (x2)



Phillips Screwdriver



Hammer Drill



3/16" Masonry Bit



Safety Glasses



TOOLS AND HARDWARE REQUIRED FOR THIS PAGE

SEC 18

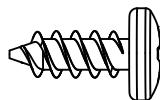
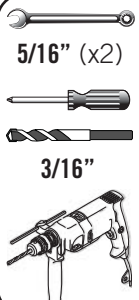

ADZ (x4)



SEC

18.1

CENTER & LEFT DOOR ADJUSTMENT

You may need to adjust the height of the Center Door to eliminate an uneven gap. Loosen the two Nuts on the Hex Bolt on the Carriage Bracket to raise or lower the Center Door. Once the door has been adjusted to the desired height, retighten the Nuts.

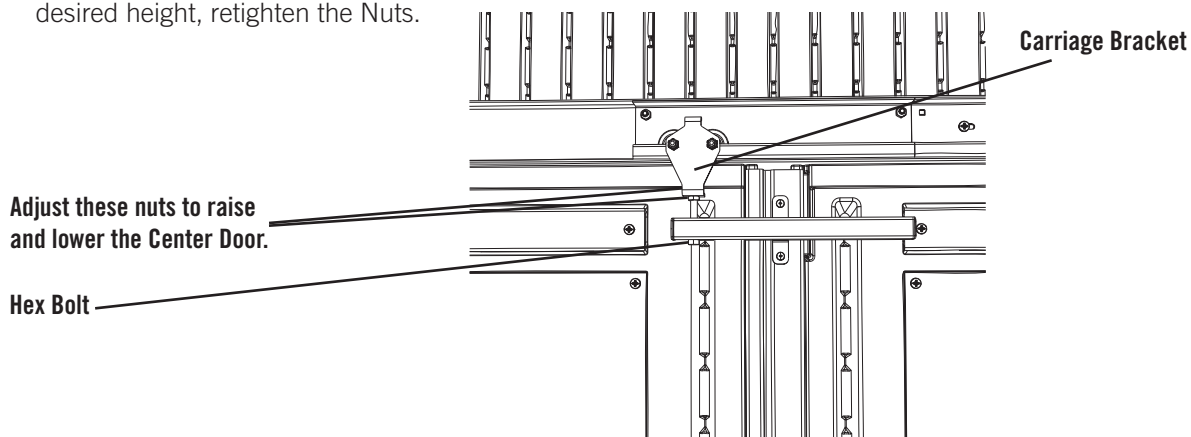

SEC

18.2

ANCHORING SHED

If you plan on anchoring your shed to your platform, ensure your shed is in the position you would like it to be on your Platform. While another person holds the Shed in place, use a 3/16" masonry bit (for concrete platforms) or a 3/16" drill bit (for wooden platforms) to drill through the hole in each L-Bracket at the bottom of each Wall Support Channel and into the platform beneath (2" deep). The anchoring hardware used depends on your platform. If you have a concrete platform, we recommend using 1/4" x 2" Cement Screws, e.g., Tapcon Anchors. If you have a wood-framed platform, we recommend using 1/4" x 1" Lag Bolts. **Do not exceed a 3/8" diameter bolt.** Use a hammer drill to insert the cement screws or a regular drill to insert the Lag Bolts. **Refer to your local hardware store for this hardware.** You can anchor each Door Frame Support Brackets to the Floor using two (2) 1/4" x 5/8" Pan-Head Screws (ADZ), or you can anchor each of them to your platform using two (2) 1/4" Anchor Bolts or 1/4" Lag Bolts. **Do not exceed a 1/4" diameter bolt for the Door Frame Support Brackets. Refer to your local hardware store for this hardware.**

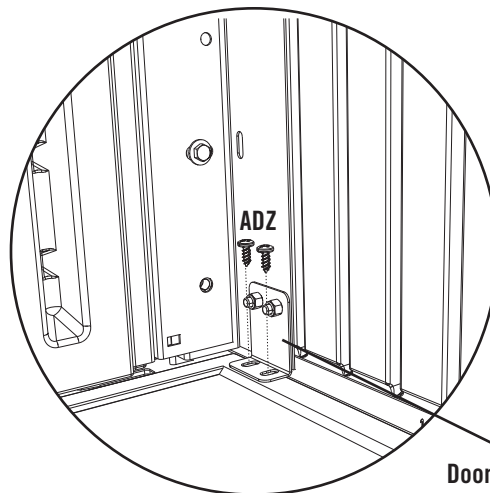
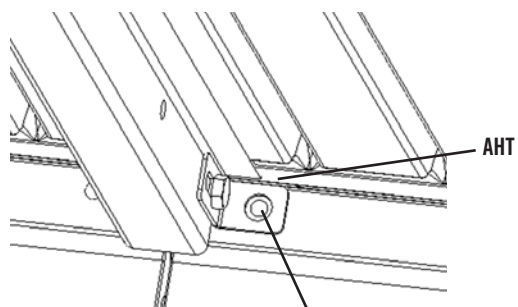

Note: Insert anchoring hardware through the Floor Brackets (aht) attached to the bottom of each Wall Support.

Door Frame Support Bracket

CLEANING & CARE

Congratulations on your Lifetime® product purchase. By following the instructions below, your new Lifetime product should provide you with years of service and enjoyment.

Cleaning and Care

The polyethylene panels are stain- and solvent-resistant. Most stains can be removed, using a mild soap and a soft-bristled brush. Abrasive cleaning materials may scratch the plastic and are not recommended. Repair scratches or rust spots on the metal by sanding the affected area lightly; using a rust preventative spray primer; and finally, spraying with a high-gloss spray enamel paint. Avoid placing a direct heat source on or near surfaces unless using a heat barrier.

LIFETIME OUTDOOR SHED EQUIPMENT

10-YEAR LIMITED FACTORY WARRANTY

THE MANUFACTURER RESERVES THE RIGHT TO MAKE SUBSTITUTIONS TO WARRANTY CLAIMS IF PARTS ARE UNAVAILABLE OR OBSOLETE.

1. Lifetime outdoor sheds are warranted to the original purchaser to be free from defects in material or workmanship for a period of ten years from the date of original retail purchase. The word “defects” is defined as imperfections that impair the use of the product. Defects resulting from misuse, abuse or negligence will void this warranty. This warranty does not cover defects due to improper installation, alteration or accident. This warranty does not cover damage caused by vandalism, rusting, “acts of nature” or any other event beyond the control of the manufacturer.
2. This warranty is nontransferable and is expressly limited to the repair or replacement of defective product. If the product is defective within the terms of this warranty, Lifetime Products, Inc. will repair or replace defective parts at no cost to the purchaser. Shipping charges to and from the factory or distribution center are not covered and are the responsibility of the purchaser. Labor charges and related expenses for removal, installation or replacement of the shed or its components are not covered under this warranty.
3. This warranty does not cover scratching or scuffing of the product that may result from normal usage. In addition, defects resulting from intentional damage, negligence, unreasonable use or hanging from the truss will void this warranty.
4. Liability for incidental or consequential damages is excluded to the extent permitted by law. While every attempt is made to embody the highest degree of safety in all equipment, freedom from injury cannot be guaranteed. The user assumes all risk of injury resulting from the use of this product. All merchandise is sold on this condition, and no representative of the company may waive or change this policy.
5. This product is not intended for institutional or commercial use; Lifetime Products, Inc. does not assume any liability for such use. Institutional or commercial use will void the warranty.
6. This warranty is expressly in lieu of all other warranties, expressed or implied, including warranties of merchantability or fitness for use to extent permitted by Federal and state law. Neither Lifetime Products, Inc., nor any representative assumes any other liability in connection with this product. This warranty gives you specific legal rights, and you may also have other rights which vary from state to state.

PLEASE INCLUDE YOUR DATED SALES RECEIPT AND PHOTOGRAPHS OF DAMAGED PARTS.

REPORT PRODUCT DEFECTS IN WRITING TO:

Lifetime Products, Inc., PO Box 160010 Clearfield, UT 84016-0010
or call 1-800-225-3865 M-F 7 a.m. to 5 p.m. MST.

REGISTER YOUR PRODUCT FOR QUICKER CUSTOMER SERVICE.

Visit www.lifetime.com or call 1-800-225-3865 to register your product today.

FOR INTERNATIONAL WARRANTY CLAIMS:

All warranty claims must be accompanied by a sales receipt. Report all warranty claims in writing to your regional sales support representative. Please include your dated sales receipt and photographs of damaged parts.

To Identify the representative for your region — Please visit: www.lifetime.com/international



www.lifetime.com

ENHANCE YOUR LIFETIME® PURCHASE BY ADDING ACCESSORIES OR OTHER GREAT PRODUCTS

To purchase accessories or other Lifetime Products, visit us at:

www.lifetime.com

Or call: 1-800-424-3865

