

PREPARATION

Before beginning the assembly of the product, make sure all parts are present. Compare the parts with the package contents list and hardware contents list. If any parts are missing or damaged, do not attempt to assemble the product. Tool required for assembly (included): Allen Key and Wrench.

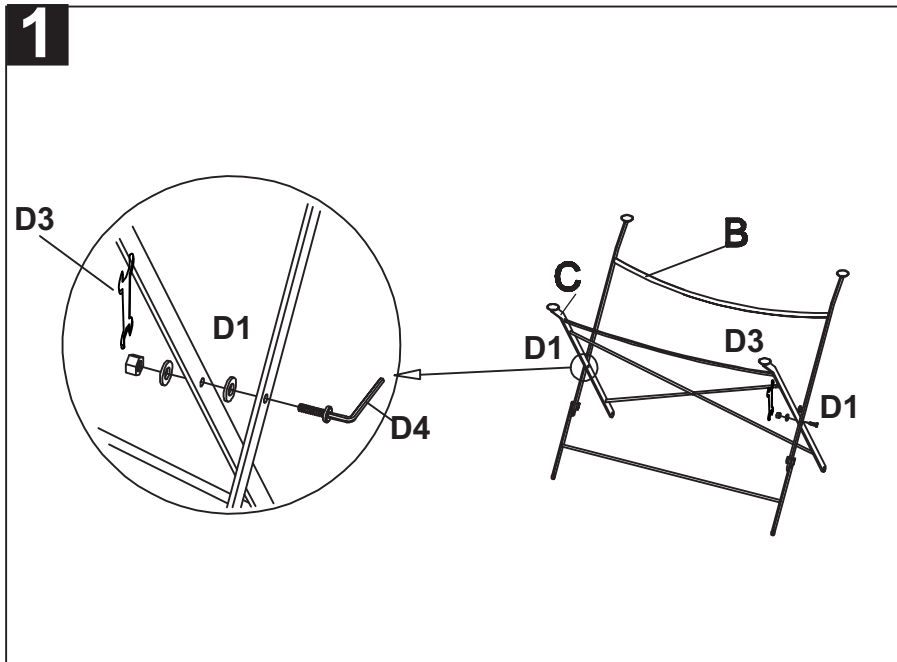

Step 1: put the Leg X (C) inside the Leg L (B) as shown on the picture by using the Allen Bolt L (D1). Tighten it with the Wrench (D3) and the Allen Key (D4).

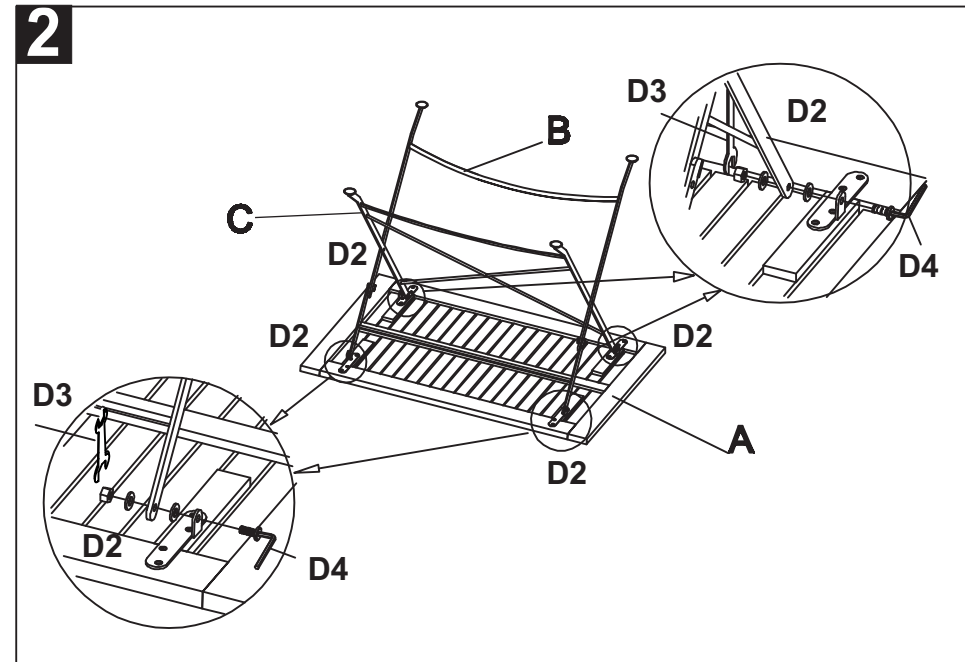

Step 2: turn down the table top (A) and attach the legs as shown on the picture by using Allen Bolt S (D2). Tighten it with the Wrench (D3) and the Allen Key (D4).





CARE AND MAINTENANCE

Store outdoor furniture indoors or cover well when it is not in use. Dust regularly with small brush or vacuum. Spills should be taken care of immediately before they harden or stain with a slightly dampened sponge.

NOTICE

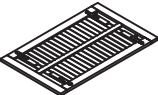
Please make sure that you have all parts indicated before you begin assembly of this item.

Part List and Hardware List

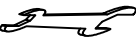
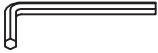
PIECE	DESCRIPTION	PICTURE	QUANTITY
A	Table Top		1 X
B	Leg L		1 X
C	Leg X		1 X
D1	Allen Bolt L	 M8x25	4 X
D2	Allen Bolt S	 M6x20	4 X
D3	Wrench		1 X
D4	Allen Key		1 X

 **SAFAVIEH**
OUTDOOR LIVING

MODEL# PAT6709

Product Dimension: 41.34"W x 25.59"D x 29.13"H

Weight capacity : 40 lbs.

Warning : Do not stand on the table

Warning : Do not torque bolts / screws

