



# Bathroom Vanity Set Installation Guide

## PLEASE NOTE

- Licensed Professional installation recommended
- Prior to installation please check items received & report any missing items to your retailer immediately.
- Protect all surfaces from sharp objects, high heat sources, direct prolonged sunlight & chemical hazards.



## Required Tools - **Not In Box**



Tape Measure



Pencil



Electric Drill



Phillips Screwdriver



Adjustable Wrench

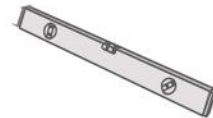

Spirit Level



Silicone Sealant

## How to handle your counter top

**1** Lift the counter (using two people for counters 50" or larger) from the front side, leaving the back side on the bottom of the box. Bring to a vertical position

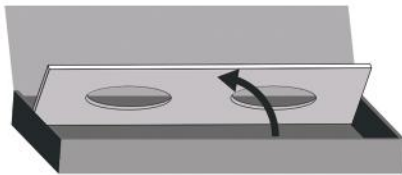

Never lift the counter flat!



Never carry the counter flat!



**2** Remove counter from the box while maintaining it's vertical position. It is acceptable to use the sink openings as grasp locations, but highly preferable to also support it from the bottom. The vertical position must be maintained during the entire moving process.

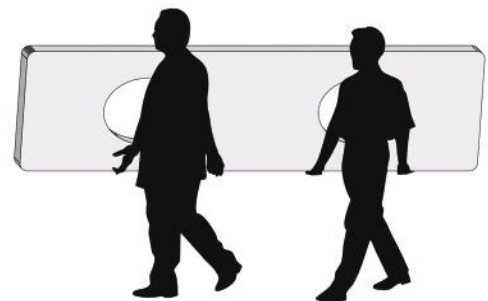

## How to adjust hinges

Adjust height

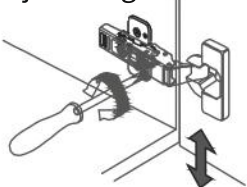

Adjust laterally

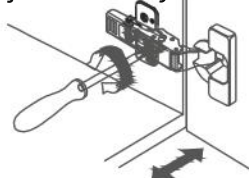

Adjust depth

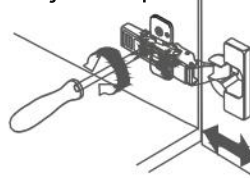

Remove

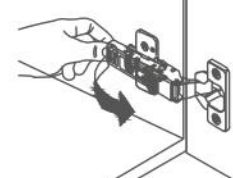

Install

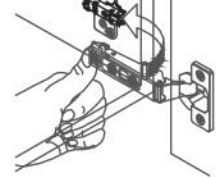

## How to remove & install drawers

### Removal

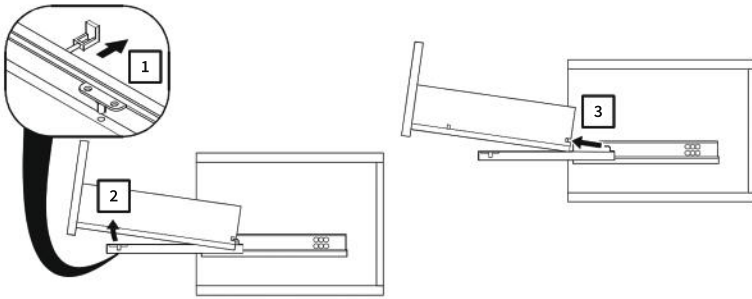

### Installation

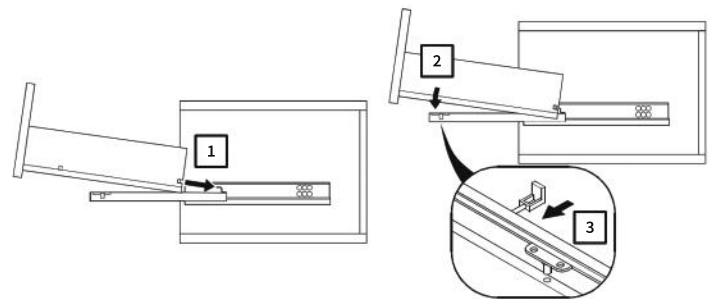

## How to install mirrors

**1** Measure the space where you wish to install the mirror. Mark the location of the screws to be drill in.

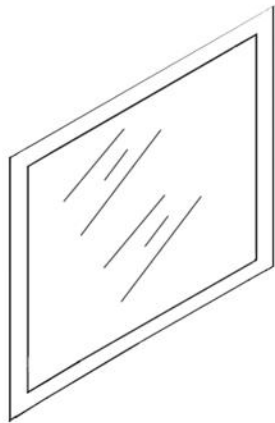

**2** Using the screws provided, drill into marked spots, leaving about 1/4" to 1/2" from the wall.

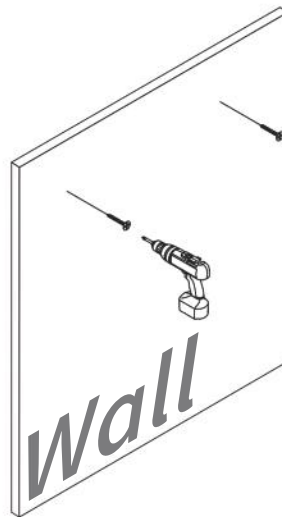

**3** Carefully place the mirror back hinges onto the screws.

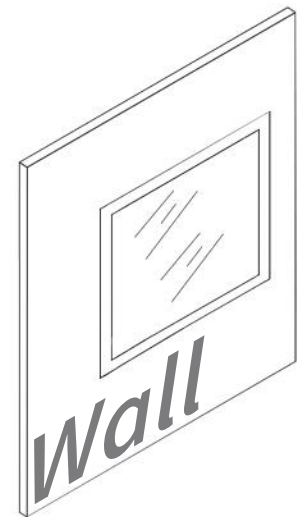

## Packing List & Receiving Verification

Most MTD's vanities are pre-assembled & therefore have very few parts. Your package should include the following:

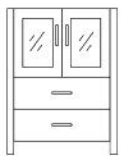

Base Cabinet

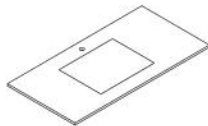

Counter Top

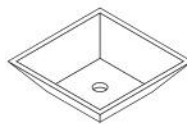

Sink(s)



Mirror(s)



Faucet(s)



Pop-up Drain(s)  
& Hoses



### PLEASE NOTE

Plumbing parts are not included. We recommend consulting with a license plumber prior to installation. All plumbing parts (not including the vanity & items in the packing list) shown in the diagrams can be purchased at any hardware store. Your items may appear slightly different from illustrations.

In most cases your sinks are going to be pre-attached to the counter top, however, many models come with separate sink/s to be attached to counter top. If so, please read the following instructions as indicated below:

## Counter top & sink installation

Counter tops should be handled with extreme caution & should always be lifted vertically and be maintained in a vertical position while lifting, never lift or carry your counter top in a flat position refer to [How to handle your counter top - page 1]. Determine what type of sink(s) you have & proceed to the installation process.

### 1 Under-mount sinks

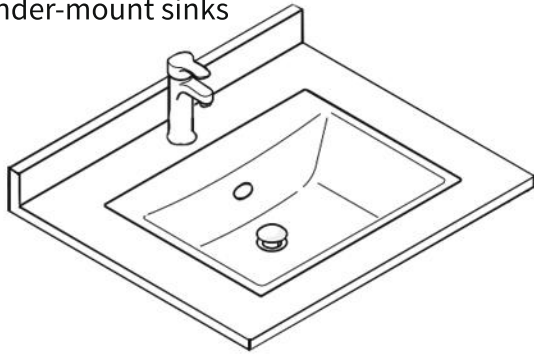

### 2 Vessel over-mount sinks

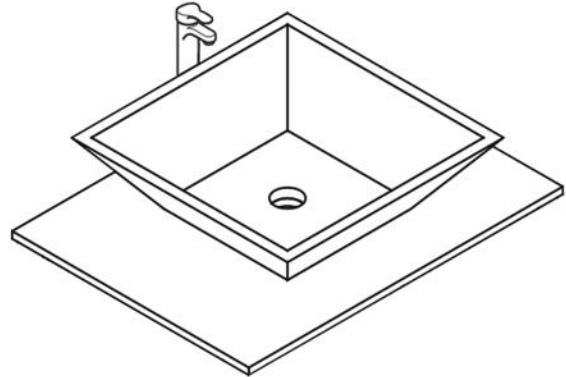

## 1 Under-mount sink/counter installation

Please note: If your counter top arrived with pre-assembled sink please skip to Step 7.

1. Safely remove the packaging from your counter top and place it on a flat surface facing down. If your counter top is made of marble/natural stone, make sure to place it on an evenly flat surface to avoid any movements.

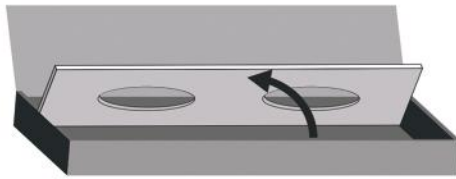

2. Remove the sink from its packaging box. Identify the front and bottom portion of the sink(s).

3. Using the Silicone Sealant provided, apply a liberal amount around the perimeter of the pre-cut sink hole.

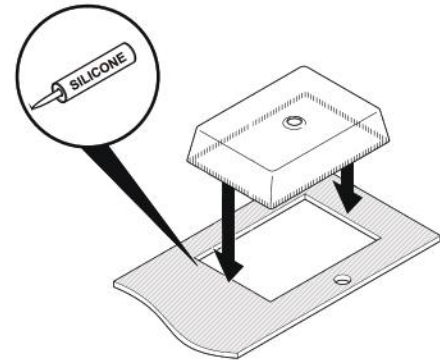

4. Place the sinks upside down on the area where the sealant was utilized. Apply moderate pressure to secure sink in place. DO NOT apply excessive weight.

5. Using a cloth, remove any excess sealant around the area.

6. We recommend waiting 24-hours to allow the sealant to fully cure.

7. Once the sealant has properly cured, remove the double sided tape strip that is located on top of the base cabinet. Lift the counter top in a vertical position & carefully place on top of the vanity cabinet. It is best to align your counter top with your cabinet base from back to front. We recommend acquiring help to lift & place counter top to avoid any potential breakage that may occur during installation. *Damages incurred during the installation process are not covered under warranty.*

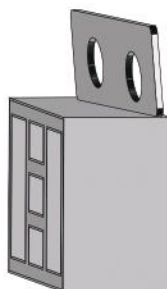
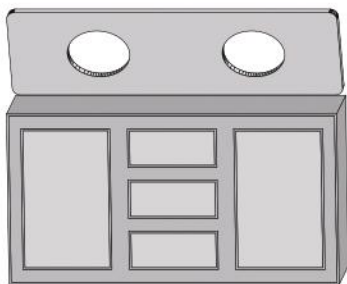

Please note: If your counter top arrived with pre-assembled sink please skip to Step 7.

1. Safely remove the packaging from your counter top and place on a flat surface facing down. If your counter top is made of marble/natural stone, make sure to place it on an evenly flat surface to avoid any movements.

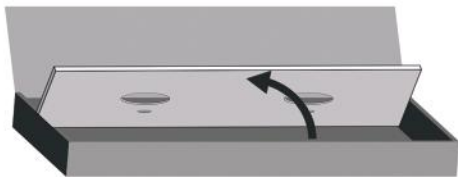

3. Place vessel sink over the predrilled drain hole.
4. If necessary, you can use a clear/white silicon sealant after plumbing has been connected to apply around the sink/s to secure it in place. The seal is not included in the box and can be purchased at any local hardware store. Please refer to the below steps before finalizing this step.

2. Remove the double sided tape strip that is located on top of the base cabinet. Lift the counter top in a vertical position, & then carefully place the counter on top of the cabinet. It is best to align your counter top with your cabinet base from back to front. We recommend acquiring help to lift & place counter top to avoid any potential breakage that may occur during installation. Damages incurred during the installation process are not covered under warranty.

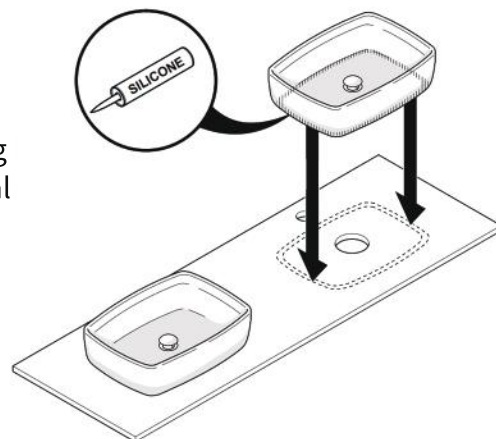

## Pop-Up Drain & P-Trap Installation

For the recommended Pop-up Installation, please see diagram below. We strongly recommend hiring a licensed plumber to properly install the drain & water connections. The diagram will specify the process & parts needed for installation. Due to a large variety of plumbing applications & city and state codes, we do not provide plumbing parts such as P-Trap and other components apart from the pop-up drain(s). Your item may appear slightly different from the illustration. These components can be purchased at any local hardware store.

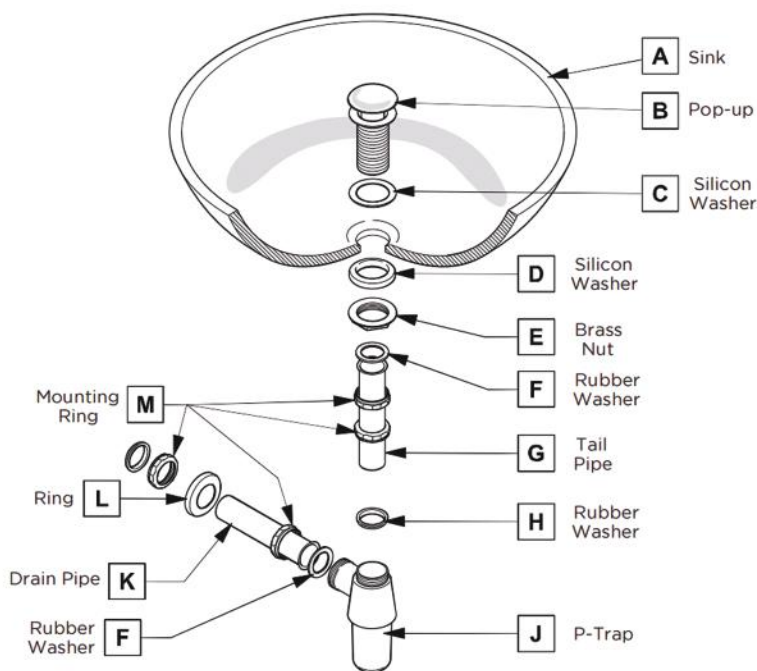

### FOR SINKS WITH OVERFLOW

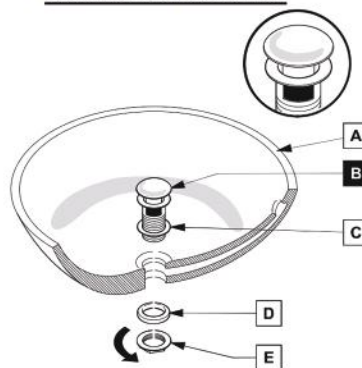

### FOR SINKS WITHOUT OVERFLOW

