

The logo for Greenworks, featuring the brand name in a bold, lowercase, sans-serif font. The text is white and set against a black, rounded hexagonal background.

12" 40-Volt Snow Shovel

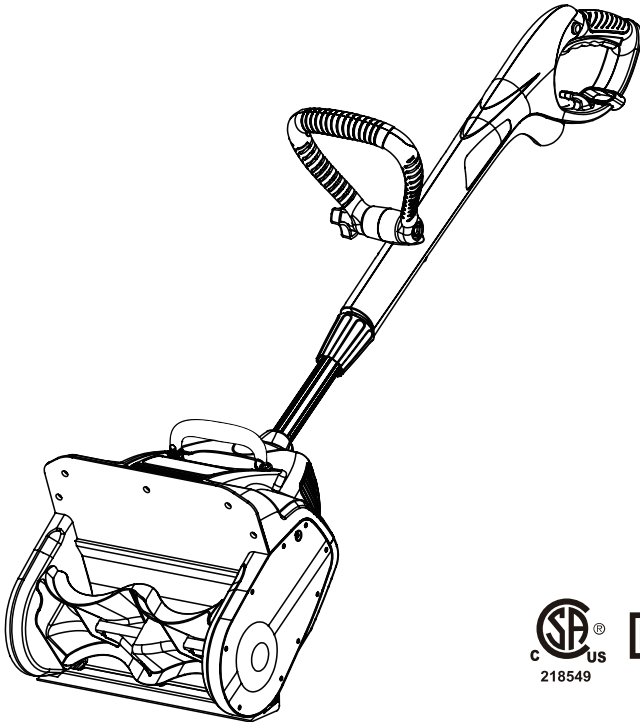

Owner's Manual

TOLL-FREE HELPLINE: 1-888-90WORKS (888.909.6757)

 Read all safety rules and instructions carefully before operating this tool.

CONTENTS

Contents	2
Product specifications.....	2
Safety information.....	3-4
Symbols.....	5-6
Electrical.....	7-8
Know your snow shovel	9
Assembly	10-11
Operation.....	12-13
Maintenance	14-18
Troubleshooting	19
Warranty	20
Exploded View.....	21
Parts List.....	22-23
Notes	24-25

PRODUCT SPECIFICATIONS

8 AMP ELECTRIC SNOW SHOVEL

Motor	120 V AC, 60 Hz, 8 A
No-load speed	Up to 2600 RPM
Clearing width.....	12 in. (30 cm)
Clearing depth.....	4 in. (10.2 cm)
Impeller size	10 in. (25.4 cm)
Discharge distance.....	Up to 20 ft. (6 m)
Weight	14.6 lbs (6.6 kg)



SAFETY INFORMATION

FOLLOW THESE RULES WHILE OPERATING THE SNOW SHOVEL

IMPORTANT

READ AND UNDERSTAND ALL INSTRUCTIONS. Failure to follow all instructions listed below may result in electric shock, fire, and/or serious personal injury.

- Walk. Do not run.
- Verify that the Snow Shovel is not in contact with anything before turning it on.
- Stay away from the discharge opening at all times. Keep face, hands, and feet away from concealed, moving, or rotating parts.
- Be attentive when using the Snow Shovel, and stay alert for holes in the terrain and other hidden hazards or traffic.
- Do not use the Snow Shovel on a gravel or crushed rock surface. Use extreme caution when crossing gravel/crushed rock drives, walks, or roads.
- Move up and down slopes when clearing snow. Do not go across a slope. Use caution when changing direction. Do not use this Snow Shovel to clear snow from steep slopes.
- Do not attempt to use the Snow Shovel on a roof or on any steeply inclined slippery surface.
- Do not operate the Snow Shovel if the guards, plates, and other safety protective devices are not in place.
- Do not operate the Snow Shovel near glass enclosures, automobiles, trucks, window wells, drop-offs, etc. without properly adjusting the angle of the snow discharge. Keep children and pets away from the work area.
- Do not force or overload the Snow Shovel. The Snow Shovel will perform better and safer when it is used at the rate that it was designed to work at.
- Do not operate the Snow Shovel at high speeds on slippery surfaces. Look behind, and exercise caution when backing up.
- Do not direct the discharge toward people, and do not allow anyone to move in front of the Snow Shovel while it is in use.
- Wear safety glasses or goggles that meet ANSI Z87.1 standards, and wear ear/hearing protection when using this Snow Shovel.
- Use the Snow Shovel in daylight or in good artificial light.
- Avoid accidental start-ups. Remain in the starting position when turning the Snow Shovel on. The operator and the Snow Shovel must be in a stable position during start-up. See the section entitled Starting/Stopping Instructions.
- Use the proper tool. Only use this Snow Shovel for the purpose that it was designed for.
- Do not overreach. Always keep proper footing and balance.
- Hold the Snow Shovel with both hands while it is in use. Keep a firm grip on the handles or the grips.
- Keep hands, face, and feet away from all moving parts. Do not touch or try to stop the impeller while it is rotating.
- If the impeller does not rotate freely due to frozen ice, thaw the Snow Shovel thoroughly before

SAFETY INFORMATION

- attempting to use it.
- Keep the impeller clear of debris.
- Do not attempt to clear the impeller while the motor is running or while the Snow Shovel is plugged in it. Turn the motor off and unplug the Snow Shovel from the extension cord or the outlet.
- Keep clothing and body parts away from the rotor.
- Do not operate the motor at a faster speed than necessary. Do not run the motor at high speed while not clearing snow.
- Stop the motor when snow clearing is delayed or when moving from one location to another.
- Unplug the Snow Shovel when it is being transported and when it is not in use.
- After striking a foreign object, turn the Snow Shovel off and unplug it, and then inspect it for damage. Repair any damage before restarting and using the Snow Shovel.
- If the Snow Shovel starts to vibrate abnormally, stop the Snow Shovel immediately and attempt to determine the cause. Vibration is generally an indication of danger.
- Stop the motor and unplug the Snow Shovel whenever the operator is not in the operating position, before unclogging the impeller, and before making any repairs, adjustments, or inspections.
- Do not discharge snow onto public roads or near moving traffic.
- Allow the Snow Shovel to run for a few minutes after clearing snow in order to prevent moving parts from freezing.
- Use only the manufacturer's original replacement parts and accessories for this Snow Shovel. The use of unauthorized parts or accessories could lead to serious injury to the user or damage the Snow Shovel, and will void the warranty.
- Do not use the Snow Shovel in the hand held position. Do not pick up the Snow Shovel while it is plugged and running. The Snow Shovel is designed to travel along the ground.









GENERAL SAFETY RULES

- Verify that the Snow Shovel is secure while transporting.
- Store the Snow Shovel in a dry area, locked up or high enough to prevent unauthorized use or damage, and out of the reach of children.
- Do not douse or squirt the unit with water or any other liquid. Keep handles dry, clean, and free of debris. Clean the Snow Shovel after each use. See the section entitled Cleaning and Storage.
- If the labels on the Snow Shovel become defaced or start to lift off, contact the Toll-Free Helpline, at 1-888-909-6757.
- Keep these instructions in a safe place for future reference. Refer to them often, and use them to instruct other users. Anyone who uses this Snow Shovel must read these instructions carefully.
- Maintain the Snow Shovel with care. Follow the instructions for lubricating and changing accessories.

SAVE THESE INSTRUCTIONS



SYMBOLS

Some of the following symbols may be used on this product. Please study them and learn their meaning. Proper interpretation of these symbols will allow you to operate the product better and safer.

SYMBOL	NAME	DESIGNATION/EXPLANATION
V	Volts	Voltage
A	Amperes	Current
Hz	Hertz	Frequency (cycles per second)
W	Watts	Power
min	Minutes	Time
~	Alternating Current	Type of current
≡	Direct Current	Type or a characteristic of current
n_0	No Load Speed	Rational speed, at no load
	Class II Construction	Double-insulated construction
/min	Per Minute	Revolutions, strokes, surface speed, orbits etc., per minute
	Wet Conditions Alert	Do not expose to rain or use in damp locations
	Read The Operator's Manual	To reduce the risk of injury user must read and understand operator's manual before using this product.
	Eye and Head Protection	Wear eye and head protection when operating this equipment.
	Ricochet	Thrown objects can ricochet and result in personal injury or property damage.
	Spinning Rotor	Danger – Keep hands and feet away from spinning rotor. Spinning rotor can cause severe injury.
	Keep Hands And Feet Away.	Keep hands, feet away from the discharge area.
	Keep Bystanders Away	Keep all bystanders at least 50 ft. away.

SYMBOLS

The following signal words and meanings are intended to explain the levels of risk associated with this product.

SYMBOL	SIGNAL	MEANING
	DANGER	Indicates an imminently hazardous situation, which, if not avoided, will result in death or serious injury.
	WARNING	Indicates a potentially hazardous situation, which, if not avoided, could result in death or serious injury.
	CAUTION	Indicates a potentially hazardous situation, which, if not avoided, may result in minor or moderate injury.
	CAUTION	(Without Safety Alert Symbol) Indicates a situation that may result in property damage.

SERVICE

Servicing requires extreme care and knowledge and should be performed only by a qualified service technician. For service we suggest you return the product to your nearest **AUTHORIZED SERVICE CENTER** for repair. When servicing, use only identical replacement parts.

W A R N I N G

To avoid serious personal injury, do not attempt to use this product until you have read this Owner's Manual thoroughly and understand it completely. If you do not understand the warnings and instructions in this Owner's Manual, do not use this product. Call the Toll-free Helpline (1-888-909-6757) for assistance.

W A R N I N G



The operation of any power tool can result in foreign objects being thrown into your eyes, which can result in severe eye damage. Before beginning power tool operation, always wear safety goggles or safety glasses with side shields and, when needed, a full face shield. We recommend Wide Vision Safety Mask for use over eyeglasses or standard safety glasses with side shields. Always use eye protection which is marked to comply with ANSI Z87.1.

SAVE THESE INSTRUCTIONS

ELECTRICAL

DOUBLE INSULATED SNOW SHOVEL

DANGER

Basic safety precautions should always be followed when using electric tools in order to reduce the risk of fire, electric shock, and personal injury. Read the entire Owner's Manual carefully and understand it thoroughly before using this Snow Shovel. Pay close attention to the operating instructions and safety rules.

This snow shovel is "DOUBLE INSULATED" 

WARNING

In order to reduce the risk of electric shock when operating this Snow Shovel, use only a CSA-listed extension cord that is approved for outdoor use, such as Type SJTW, 16AWG, and that has a lower temperature rating of -40° F (-40° C).

- Ground Fault Circuit Interrupter (GFCI) protection should be provided on the circuit(s) or outlet(s) that will be used for this Snow Shovel. For an extra measure of safety, use a receptacle that has built-in GFCI protection.
- The nameplate on the Snow Shovel indicates the voltage used. Do not connect the Snow Shovel to an AC circuit that provides a different voltage from the voltage that is indicated on the nameplate.

MINIMUM GAUGE FOR EXTENSION CORDS (AWG) (WHEN USING 120 V ONLY)

Amp Rating		Total Length of Cord in Feet (meters)			
More Than	Not More Than	25' (7.6 m)	50' (15 m)	100' (30.4 m)	150' (45.7 m)
0	6	18	16	16	14
6	10	18	16	14	12
10	12	16	16	14	12
12	16	14	12	Not Recommended	

WARNING

In order to prevent electric shock, use an extension cord that is suitable for outdoor use.

- Inspect the extension cord and the power cord on a regular basis. Look for deterioration, cuts, or cracks in the insulation. Inspect the connections for damage. Repair or replace the extension cord or the power cord if any damage is found.
 - Verify that the rotor and all moving parts have come to a complete stop, and disconnect the Snow Shovel from the power supply in order to prevent accidental start-ups before cleaning or performing any inspections or repairs.
 - Do not abuse the extension cord. Do not carry the Snow Shovel by the power cord or pull on the cord in order to disconnect it from the receptacle.
-

ELECTRICAL

- Keep the extension cord away from heat, oil, and sharp edges in order to prevent damage.
- If the extension cord is damaged in any manner while it is plugged in, disconnect it from the outlet immediately.
- Prevent any possible disconnection of the power cord from the extension cord while the Snow Shovel is in use by using the cord retainer and guide bar. Refer to the section entitled Using the Cord Retainer.
- Avoid accidental start-ups. Do not carry the Snow Shovel with a finger on the switch while it is plugged in. Verify that the switch is in the "OFF" position before plugging in the Snow Shovel.
- Unplug the Snow Shovel and allow it to cool down before putting it into storage. Store the Snow Shovel indoors.
- Unplug the Snow Shovel when it is not in use and before performing any maintenance or repairs.the nameplate.

SAVE THESE INSTRUCTIONS

KNOW YOUR SNOW SHOVEL

Read this operator's manual and safety rules before operating your snow shovel. Compare the illustration in Figure 1 to your snow shovel in order to familiarize yourself with the location of various controls and adjustments. Save this manual for future reference.

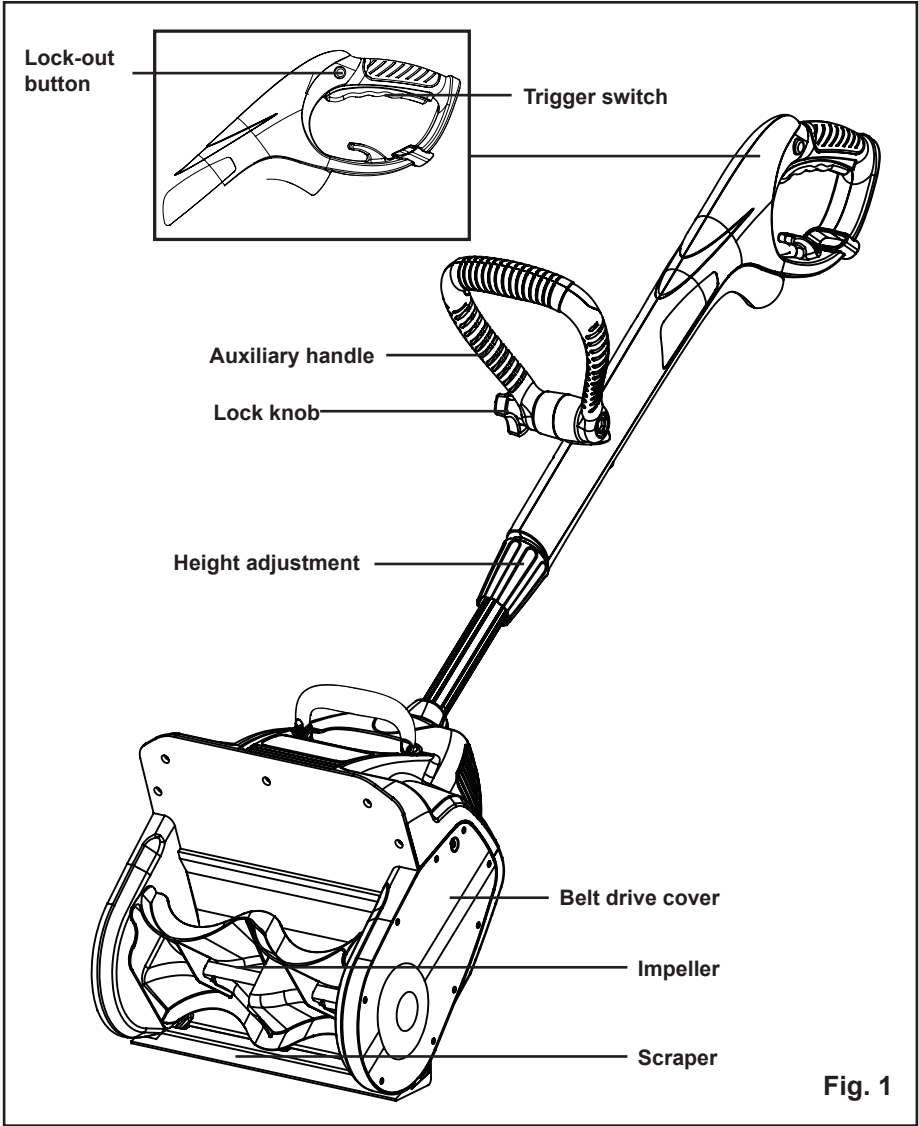

Fig. 1

ASSEMBLY INSTRUCTIONS

UNPACKING

This product has been shipped completely assembled.

- Carefully remove the product and any accessories from the box. Make sure that all items listed in the packing list are included.
- Inspect the product carefully to make sure no breakage or damage occurred during shipping.
- Do not discard the packing material until you have carefully inspected and satisfactorily operated the product.
- If any parts are damaged or missing, please call 1-888-909-6757 for assistance.

PACKING LIST

- Snow shovel
- Owner's Manual

W A R N I N G

If any parts are damaged or missing, do not operate this product until the parts are replaced. Failure to heed this warning could result in serious personal injury.

W A R N I N G

Do not connect to power supply until assembly is complete. Failure to comply could result in accidental starting and possible serious personal injury.

W A R N I N G

Do not attempt to modify this product or create accessories not recommended for use with this product. Any such alteration or modification is misuse, and could result in a hazardous condition leading to possible serious personal injury.

ASSEMBLY INSTRUCTIONS

⚠ WARNING

Do not allow familiarity with this product to make you careless. Remember that a careless fraction of a second is sufficient to inflict serious injury.

⚠ WARNING

Always wear safety goggles or safety glasses with side shields when operating power tools. Failure to do so could result in objects being thrown into your eyes, resulting in possible serious injury.

⚠ WARNING

Do not use any attachments or accessories not recommended by the manufacturer of this product. The use of attachments or accessories not recommended can result in serious personal injury.

USING THE CORD RETAINER (See Figure 2)

This Snow Shovel is equipped with a cord retainer in order to prevent the extension cord from disconnecting from the power cord while the Snow Shovel is in use.

NOTE: Do not plug the extension cord into the outlet until it has been connected to the cord retainer and plugged into the Snow Shovel.

To use the cord retainer:

- Fold the extension cord to form a tight loop near the retainer.
- Push the loop through the bottom hole in the retainer.
- Slide the loop over the retaining clip, and pull down until the cord is secured.

NOTE: Use a CSA or CuL-approved extension cord. A 100' (30.4 m), 14-gauge cord is recommended. A 50' (15.2 m), 16-gauge cord is also acceptable.

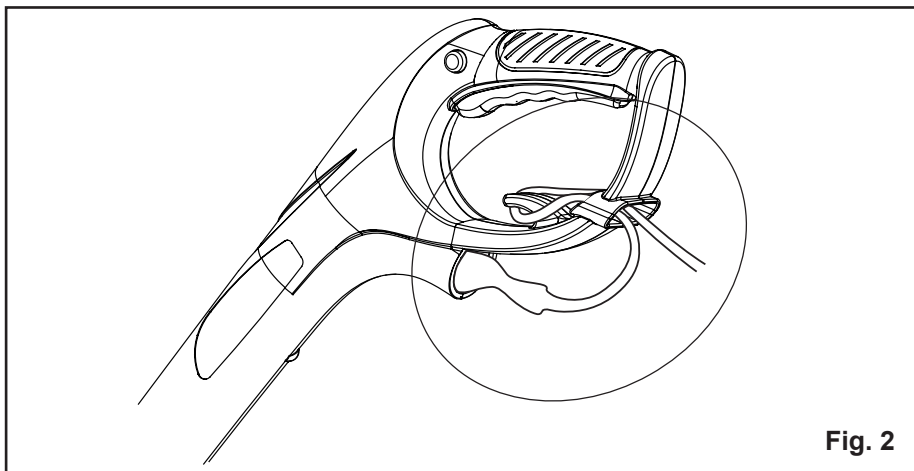

Fig. 2

OPERATING INSTRUCTIONS

STARTING THE SNOW SHOVEL *(See Figures 3-4)*

Avoid accidental start-ups. Verify that the operator is in the starting position when using the snow shovel. In order to avoid serious injury, the operator and unit must be in a stable position when starting the Snow Shovel.

Follow this sequence exactly in order to start the Snow Shovel.

- Verify that the Snow Shovel is plugged in.
- Press and hold the red lock-out button (Fig. 3).
- While holding the lock-out button, lift and hold the trigger switch.

NOTE: The Snow Shovel will not start if the lock-out button is not held until the trigger switch is lifted.

- Hold the handles and begin to use the Snow Shovel (Fig.4).

STOPPING THE SNOW SHOVEL

- Release the trigger switch.
- The lock-out button will pop out, and the Snow Shovel will stop.

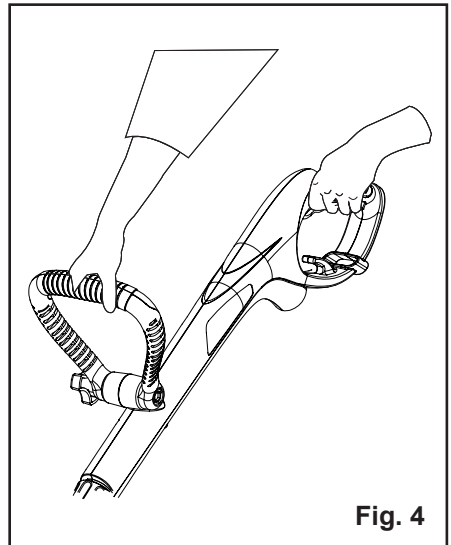
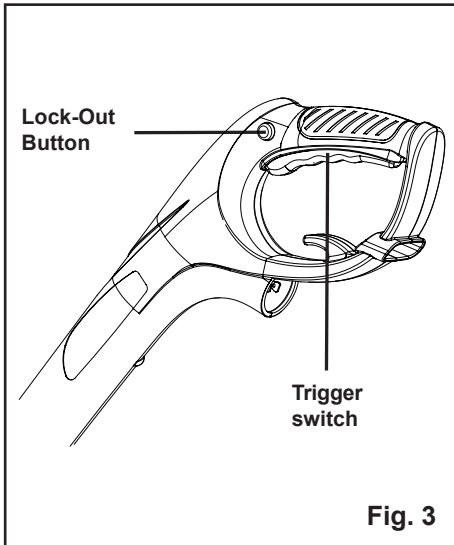

OPERATING INSTRUCTIONS

USING THE SNOW SHOVEL

- Start the Snow Shovel by following the Starting instructions. The depth and weight of the snow will determine the forward speed.
- Push the Snow Shovel forward so that it rides on the scraper.
- Verify that the power cord is attached to the cord retainer. The power cord should trail to the side of the operator.

MAINTENANCE

SERVICING

Servicing should be performed by a qualified technician. Replacement parts for this Snow Shovel must be identical to the parts that they replace. If repairs are necessary, contact the Toll-Free Helpline, at 1-888-909-6757.

INSPECTING/REPLACING THE DRIVE BELT (See Figures 5-6)

When servicing the Snow Shovel, use only the manufacturer's original replacement parts. Inspect the drive belt for wear once per year or every 50 hours of operation, whichever comes first. If the drive belt needs to be replaced, follow these steps.

In order to avoid serious personal injury, turn off the Snow Shovel and allow it to cool down. Unplug the Snow Shovel before performing any maintenance.

- Remove the ten (10) screws from the belt cover using a phillips screwdriver (Fig. 5). Remove 3 screws for the impellar bracket shown in (Fig. 6). In order to reduce the risk of electric shock, replace the cover before connecting the Snow Shovel to a power source.
- Pull the belt tensioner (idler arm) away from the drive pulley. Remove the damaged or broken belt from the impeller pulley and the drive pulley inside the housing. Discard the belt in the proper manner (Fig. 6).
- Loop the new belt around the drive pulley and the impeller pulley (Fig. 6). Pull the belt tensioner (idler arm) away from the drive pulley in order to install the belt around the drive pulley.

NOTE: Verify that the washer is still in place on the impeller pulley shaft before reinstalling the belt cover.

- Reinstall the belt cover with the ten (10) screws. Reinstall the impellar pulley bracket three screws. In order to facilitate the installation, position the narrow part of the cover into the recess of the housing and install the two top screws and then push the rest of the cover down into recess and over the rotor shaft. Tighten all ten (10) screws.

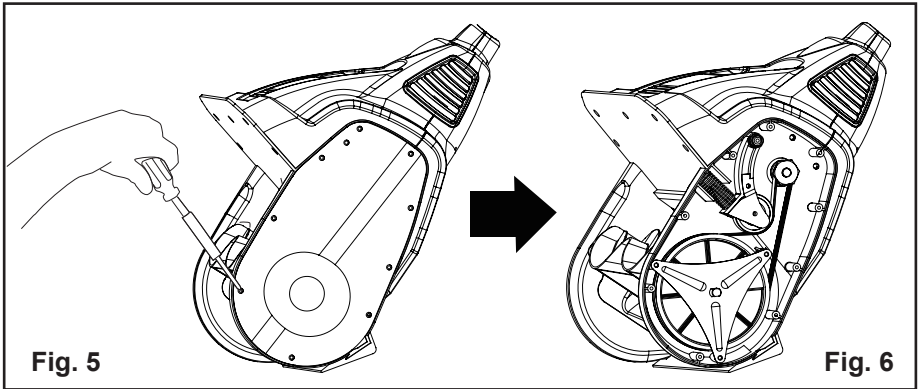

⚠ WARNING

When fitting the belt back into the main housing, verify that the belt is positioned to the right of the Drive Belt Retainer. If the belt is positioned to the left of the Drive Belt Retainer, serious damage may occur.

MAINTENANCE

REPLACING THE SCRAPER (See Figure 7)

⚠ WARNING

IN ORDER TO AVOID SERIOUS PERSONAL INJURY, TURN THE SNOW SHOVEL OFF AND UNPLUG IT BEFORE PERFORMING ANY MAINTENANCE.

Use only the manufacturer's original replacement parts.

- Place the Snow Shovel on the ground or on a work bench. Position the Snow Shovel so that the impeller is facing up.
- Remove the three (3) screws that are located beneath the impeller that secure the scraper to the housing using a phillips screwdriver. (Fig. 7).
- Remove the scraper, and discard it in the proper manner.
- Snap the new scraper into position, and attach it to the Snow Shovel by reinstalling the three (3) screws.

STORAGE

- Allow the motor to cool down before storing.
- Store the Snow Shovel in a locked location in order to prevent unauthorized use or damage.
- Store the Snow Shovel in a dry, well-ventilated area.
- Store the Snow Shovel out of the reach of children.

CLEANING

In order to avoid serious personal injury, turn the Snow Shovel off and unplug it before cleaning or servicing.

Use a small brush to clean the outside of the Snow Shovel. Do not use strong detergents. Household cleaners that contain aromatic oils such as pine and lemon, and solvents such as kerosene can damage the plastic housing and handles. Wipe off any moisture using a soft cloth.

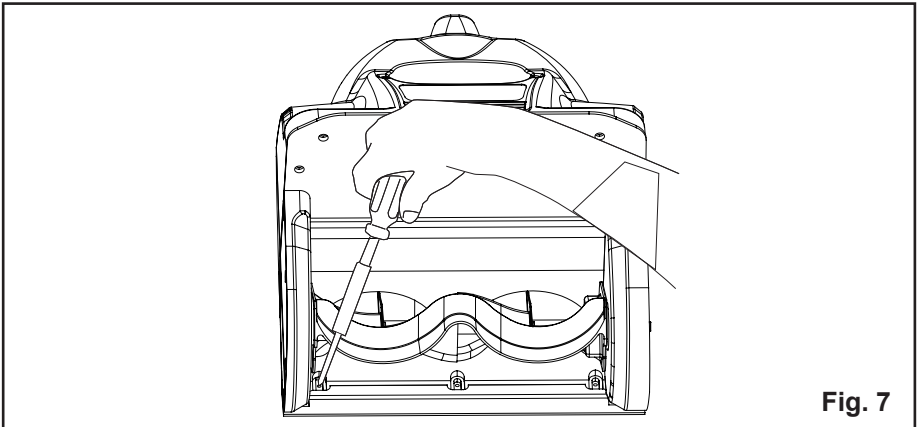

Fig. 7

MAINTENANCE

TRANSPORTING THE SNOW SHOVEL (See Figure 8)

- Allow the motor to cool down before transporting.
- Secure the Snow Shovel while transporting.
- When moving the Snow Shovel, grasp it by the top and auxiliary handles (Fig. 8).
- When transporting the Snow Shovel with the handles folded, be careful not to make contact with the discharge directional control and accidentally bend it. If the control is bent or damaged, it will not be possible to adjust the vanes.



MAINTENANCE

IMPELLOR REPLACEMENT



- Remove the nut from the left hand side of the impellor shaft.



- Remove the 10 screws from the side cover.

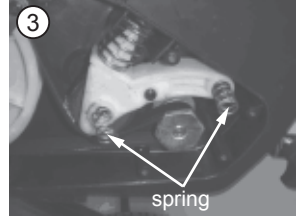

- Be sure not to lose the 2 springs.



- Remove the nut from the impellor shaft.



- Remove the 3 screws holding the pulley support plate.

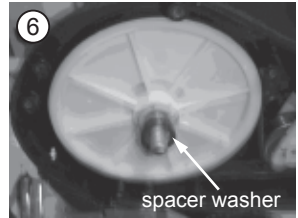

- Remove the plate and the two spacer washers.

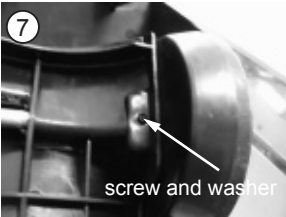

- Remove the 2 screws and 2 washers.



- Remove the pulley and belt.



- Remove the impellor shaft nut from the right hand side.



- Withdraw the impellor shaft from the left hand side.

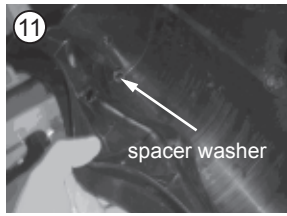

- Withdraw the old/damaged impellor. Be sure to keep the 2 spacer washers from the right hand side of the impellor.

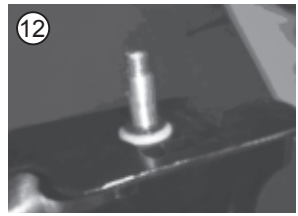

- Insert the impellor shaft in the new impellor and place the 2 washers on the right hand side.

MAINTENANCE

IMPELLOR REPLACEMENT

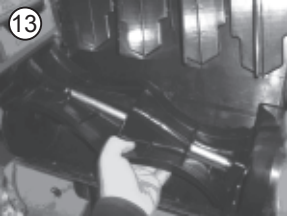

- Place the impellor and shaft back into the front scoop.



- Place the pulley back onto the impellor shaft.

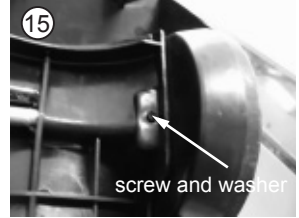

- Replace the 2 screws and 2 washers onto the impellor.



- Be sure to route the belt correctly, as shown.

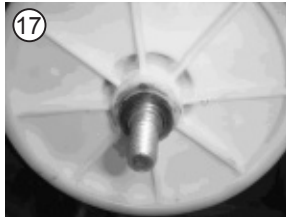

- Replace the 2 spacer washers on the impellor shaft.



- Replace the pulley support plate and the 3 retaining screws.

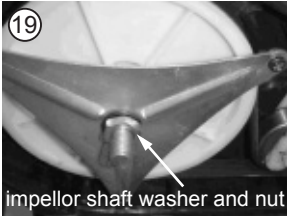

- Replace and tighten the impellor shaft washer and nut.

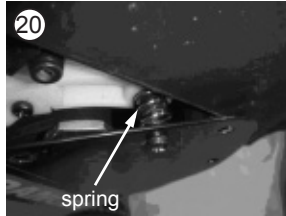

- Place the upper spring into position and then finger tighten the cover plate into place as shown.

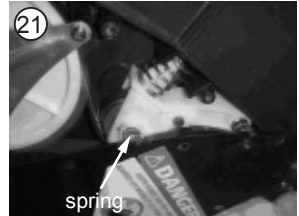

- Place the lower spring into position and slide the side cover up using slight pressure to hold the spring in place.



- Replace and tighten the remaining screws and the nut and washer.



- Re-install the impellor shaft nut and washer on the right hand side, and tighten.

TROUBLESHOOTING

PROBLEM	POSSIBLE CAUSE	SOLUTION
The snow shovel does not start.	The Snow Shovel is unplugged. The lock-out button or trigger switch were not used properly.	Verify that the Snow Shovel is plugged into an electrical outlet. Press and hold the lock-out button, and then lift and hold the trigger switch (see the section entitled Starting the Snow Shovel).
The motor is on, but The rotor does not turn.	The belt is damaged.	Replace the belt (see the section entitled Inspecting/Replacing the Drive Belt).
The snow shovel leaves a thin layer	The scraper is worn.	Replace the scraper (see the section entitled Replacing the Scraper).

LIMITED FOUR-YEAR WARRANTY



GREENWORKS™ hereby warrants this product, to the original purchaser with **proof of purchase**, for a period of four (4) years against defects in materials, parts or workmanship. GREENWORKS™, at its own discretion will repair or replace any and all parts found to be defective, through normal use, free of charge to the customer. This warranty is valid only for units which have been used for personal use that have not been hired or rented for industrial/commercial use, and that have been maintained in accordance with the instructions in the owners' manual supplied with the product from new.

ITEMS NOT COVERED BY WARRANTY:

1. Any part that has become inoperative due to misuse, commercial use, abuse, neglect, accident, improper maintenance, or alteration; or
2. The unit, if it has not been operated and/or maintained in accordance with the owner's manual; or
3. Normal wear, except as noted below;
4. Routine maintenance items such as impeller, blade sharpening;
5. Normal deterioration of the exterior finish due to use or exposure.

GREENWORKS HELPLINE (1 888 90WORKS):

Warranty service is available by calling our toll-free helpline, 9am to 5pm EST. Monday – Friday at **1 888 909 6757 (1 888 90WORKS)**.

TRANSPORTATION CHARGES:

Transportation charges for the movement of any power equipment unit or attachment are the responsibility of the purchaser. It is the purchaser's responsibility to pay transportation charges for any part submitted for replacement under this warranty unless such return is requested in writing by GREENWORKS.

EXPLODED VIEW

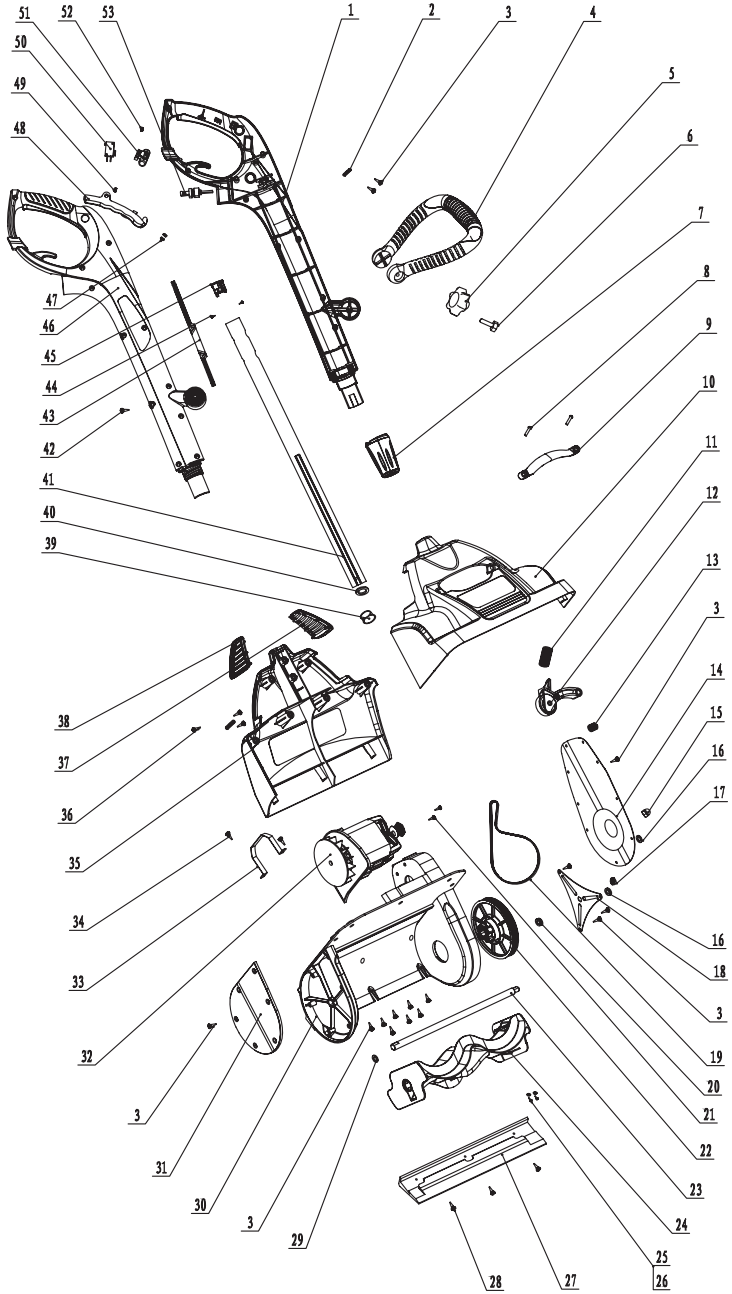

PARTS LIST

ITEM NO.	PART NO.	DESCRIPTION	QTY
1	3410298A-10	Left upper handle	1
2	3410801	Wire clip	1
3	3220298	Screw	2
4	3111098-10	Auxiliary handle assembly	1
5	3412698-10	Knob	1
6	3220698	Bolt	1
7	3410598-10	Knob	1
8	3220398	Screw	2
9	3412398-10	Carry bar	1
10	3410898-1	Front housing	1
11	3390198	Spring	1
12	3111198	Tension wheel assembly	1
13	3390298	Spring	2
14	3330298	Left cover	1
15	3220998	Cover nut	1
16	3290499	Washer	1
17	3220236	Nut	1
18	3330198	Impeller pulley bracket	1
19	3290198	Belt	1
20	32262198	Washer 2×13	1
21	3220598	Screw	3
22	3111298A	Impeller pulley assembly	1
23	3320198	Impellor shaft	1
24	3111398A-10	Impellor assembly	1
25	32206302A	Screw	2
26	3290173	Washer	2
27	3412098A	Snow spade	1
28	3225599	Screw	3
29	32261198	Washer	1
30	3411298-10	Lower housing	1
31	3411798	Right cover	1
32	3111498	Motor assembly	1
33	3330398	Motor mounting bar	1
34	3220475	Screw	2
35	3410998-10	Rear housing	1
36	3221199	Screw	1
37	3111698-10	Left grill assembly	1
38	3111598-10	Right grill assembly	1
39	34202625	Power cord sleeve	1
40	34201625	Rubber sealing ring	1
41	33208098	Tube	1
42	32203404	Screw	5

PARTS LIST

ITEM NO.	PART NO.	DESCRIPTION	QTY
43	36410098	Spring wire	1
44	32201198	Screw	2
45	34108098	Tube sleeve	1
46	3410198A-10	Right upper handle	1
47	3650135	B terminal	2
48	3410398-10	Switch trigger	1
49	3340111	Spring	1
50	3630129	Toggle switch	1
51	3410498-10	Lock-out switch	1
52	3340398	Spring	1
53	3640298	Inner connector	1



TOLL-FREE HELPLINE: 1-888-90WORKS (888.909.6757)

Rev: 01 (06-20-11)

 Printed in China on 100% recycle material