



Pro Grade 4-Bike Rack

Instruction Manual & Parts Catalog

Model 70210





Read and understand this entire manual before assembling, installing, operating, or servicing this product.

SAVE THIS MANUAL

Copyright© 2012 by PGS, LLC. All rights reserved. No portion of this manual or any artwork contained herein may be reproduced in any shape or form without the express written consent of PGS, LLC. Due to continuing improvements, actual product may differ slightly from the product described herein. Tools required for assembly and maintenance may not be included.

IMPORTANT SAFETY INFORMATION

This is a **SAFETY ALERT** symbol.  It is used to alert you to potential personal injury hazards. Obey all safety messages that follow this symbol to avoid possible injury or death.

 **DANGER** indicates a hazardous situation which, if not avoided, will result in death or injury.

 **WARNING** indicates a hazardous situation which, if not avoided, could result in death or serious injury.

 **CAUTION** indicates a hazardous situation which, if not avoided, could result in minor or moderate injury.

 **NOTICE** indicates important information which, if not followed, may cause damage to equipment.

SAVE THIS MANUAL

Keep this manual for the safety warnings and precautions. The manual offers important information on how to assemble, use and maintain this product.

Write the product's model number and purchase date on the cover page of this manual.

Keep this manual (and your purchase receipt) in a safe place.

UNPACKING

The shipment should be thoroughly inspected as soon as it is received. The signed "bill of lading" is acknowledgement by the carrier of receipt in good condition or shipment covered by our invoice. For your own protection, if any of the goods called for on the bill of lading are shorted or damaged, do not accept them until the carrier makes a notation on the freight bill of the shorted or damaged goods.

Notify PGS, LLC immediately if any hidden loss or damage is discovered after receipt.

Definition of Symbols

 **WARNING** concerning Risk of Eye Injury. Wear ANSI approved eye protection.

 **WARNING** concerning Risk of Hearing Loss. Wear hearing protection.

IMPORTANT SAFETY INSTRUCTIONS

1.  **Read and understand all safety warnings and instructions.** Failure to follow the warnings and instructions may result in serious injury or death. Save all warnings and instructions for future reference.

2. Personal and Work Area Safety

A.  **Always wear ANSI approved safety goggles.**

B.  **Always wear hearing protection when working in noisy environments.** Prolonged exposure to high intensity noise can cause hearing loss.

C.  **Use safety equipment.** Safety shoes, hard hat and work gloves must be used for applicable conditions.

D. **Dress appropriately.** Never wear loose fitting clothing or jewelry when working. Contain long hair, and keep hair, clothing and gloves away from moving parts.

E. **Use common sense when working.** Stay alert and concentrate when setting up and using the Bike Rack. Never work while under the influence of alcohol, drugs or medications.

Personal and Work Area Safety (continued)

F. While assembling and using the Bike Rack keep work area clean and well lighted. Keep spectators and children out of the work area.

3. **Use of the Bike Rack**

A. **Model 70210 Bike Rack must be attached to a 2" x 2" Class III or Class IV hitch receiver.**

The vehicle's hitch receiver must be properly installed by a qualified service technician and be certified to support the weight of this Bike Rack and its contents (**Model 70210 maximum weight capacity of four bikes = 150 Lbs.**).

B. **Do not modify the Bike Rack and do not use this product for purposes that it was not designed for.**

C. **Never exceed the maximum weight capacity shown in paragraph A above.**

D. **Be aware of the danger of "dynamic loading"**. This situation arises when a load is dropped onto the Bike Rack, resulting in a short term excessive load. Dynamic loading can result in damage and failure of the Bike Rack and/or hitch receiver, and personal injury to the person loading the Bike Rack.

E. **Never load people or animals onto the Bike Rack.** Keep children and spectators well clear when loading, unloading and using this product.

F. **Adhere to all Department of Transportation (D.O.T.) requirements when using this product.** Always use the Bike Straps to securely hold the bicycles in place.

G. For the vehicle that will support the Bike Rack, read all pertinent vehicle instructions

and warnings provided in the owner's manual. **Make sure the vehicle's engine is OFF, with parking brake set, before loading or unloading the Bike Rack.**

H. **Note the position of the vehicle's exhaust pipes before setting up the Bike Rack.** Make sure exhaust pipes are not in close proximity to the loaded bicycles. Flammable goods loaded on the Bike Rack could catch on fire due to heat from exhaust. If this risk exists on your vehicle, do not use the Bike Rack.

I. Do not use this Bike Rack on a trailer or 5th wheel R.V. Do not use with bicycles fitted with large accessories (such as a child carrying seat). **Do not exceed 55 MPH vehicle speed when Bike Rack is attached.**

J. Always check slide pins, cotter pins and Lock Pin for tightness prior to each trip. Replace Bike Straps annually, or at first signs of wear.

K. **Do not operate vehicle unless Bike Rack is in the upright position.** When not in use, remove Bike Rack from the vehicle and store indoors.

Keep in mind that the warnings previously discussed cannot cover all possible conditions or situations that could occur. It is important that the person loading/unloading and using this product understand that common sense and caution are factors which cannot be built into this product, and must be supplied by the operator.

Assembling and Setting Up the Bike Rack

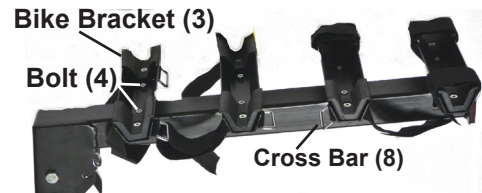

4. Assemble Cross Bar (8) to Post (18). See photo to the left.

Align hole openings and insert Bolt (13) through the upper hole opening. Secure Bolt with Lock Nut (12).

Insert Pin (15) through lower hole opening and secure with Small R-Pin (16), to position Cross Bar in the horizontal position (for bike loading), as shown in photo to left.

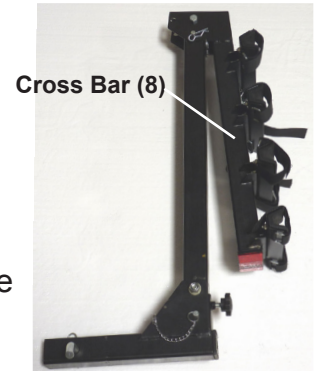

With Pin (15) and Small R-Pin (16) removed, the Cross Bar can be folded down to vertical position when attaching to vehicle hitch receiver, or when bicycles are removed. See photo to right.

5. With assembly complete, check for tightness of Bolts, Lock Nuts, R-Pins and Locking Knob, before attaching Bike Rack to vehicle's hitch receiver.

6. With assistance, Lift the Bike Rack and slide the end of the Receiver Tube (21) into the vehicle's hitch receiver. Align the hole openings and secure the Bike Rack to the vehicle with the Hitch Pin (19). Secure the Hitch Pin with Large R-Pin (20).



Always wear ANSI approved safety goggles.

1. Refer to photo above of an already assembled Bike Rack, and to the Assembly Diagram at end of this manual.

2. Attach Post (18) to the Receiver Tube (21). Insert lower portion of Post into lower bracket of Receiver Tube. Line up hole openings and insert Pin (15) into lower hole. Secure Pin with Small R-Pin (16).

Slide Nylon Washer (22) on Bolt (23) and insert Bolt through upper hole opening. Secure Bolt with another Nylon Washer (22) and Lock Nut (12). See photo to right.

Make sure Locking Knob (24) is tightened down.

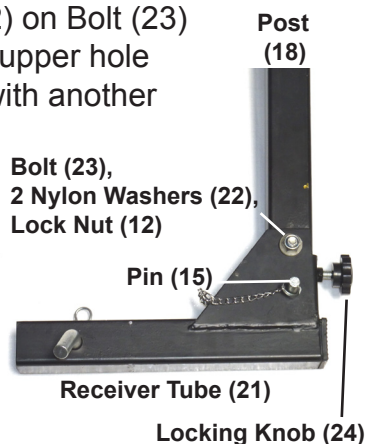

3. Connect 4 Bike Brackets (3) to top side of Cross Bar (8). Each Bike Bracket is held in place with 2 Bolts (4) and 2 Lock Nuts (7). Tighten hardware securely. See photo, upper right.

Using the Bike Rack

1. **⚠ WARNING** Make sure the vehicle is in a safe place for loading bicycles. Make sure the vehicle's engine is OFF, with parking brake set, before loading or unloading the Bike Rack.

2. Put Cross Bar (8) in horizontal position, and lock it in place with Pin (15) and Small R-Pin (16).

3. Open the hook and loop attachment on Bike Straps (5).

4. Lift and place the bicycle's upper frame on the Rubber Block (2) portion of the Bike Bracket (3). Secure the bike in place with the Bike Strap hook and loop attachment.

5. Add additional bicycles if desired. **Caution:** Make sure bicycle frames and wheels are positioned so that they will not rub against each other, or the vehicle, and cause paint damage during transit. If needed, secure bicycle wheels with straps or rope to prevent movement.

6.  **WARNING** Do not overload the Bike Rack (**maximum 4 bikes with maximum weight capacity of 150 Lbs. total**).

7. When the Bike Rack is not needed, it should be removed from the vehicle and stored indoors.

8. The empty Bike Rack can be lowered to the position shown in photo below if the vehicle's tail gate needs to be temporarily opened before any bicycles are attached. Loosen Locking Knob (24), remove Small R-Pin (16) and Pin (15), and carefully tilt back the Bike Rack when additional clearance is needed.



Never operate the vehicle when Bike Rack is in this lowered position. **Do not operate vehicle unless Bike Rack is in the upright position.**

Maintaining the Bike Rack

1. Frequently check the condition of the Bike Rack and the vehicle's hitch receiver. Make sure all components are in good condition. If the Bike Rack or hitch receiver become damaged through accident, or if any weld damage is noted, the product should be replaced.

2. Check to make sure that all hardware is tightly secured in place. Keep the Bike Rack clean.

SPECIFICATIONS

Maximum Weight Capacity	150 Lbs.
For Use With	2" x 2" Class III and IV Hitch Receivers;
Application	Holds up to 4 bicycles.
Safety Reflector	Included

Limited Warranty. PGS LLC warrants to the original retail purchaser that the product is free of defects in material and workmanship at the time of shipment. This product is warranted for 90 days from the date of purchase. This warranty is expressly in lieu of all other warranties, express or implied. Proof of purchase is required for warranty transactions; a copy of the original invoice or sales receipt is required.

Parts List

Part #	Description	Qty	Part #	Description	Qty
1	Screw	8	13	Bolt	1
2	Rubber Block	8	14	Ring	4
3	Bike Bracket	4	15	Pin	2
4	Bolt	8	16	Small R-Pin	2
5	Bike Strap	8	17	Small Chain	2
6	Washer	8	18	Post	1
7	Lock Nut	16	19	Hitch Pin	1
8	Cross Bar	1	20	Large R-Pin	1
9	Reflector	1	21	Receiver Tube	1
10	Spring Washer	2	22	Nylon Washer	2
11	Nut	2	23	Bolt	1
12	Lock Nut	2	24	Locking Knob	1

Assembly Diagram

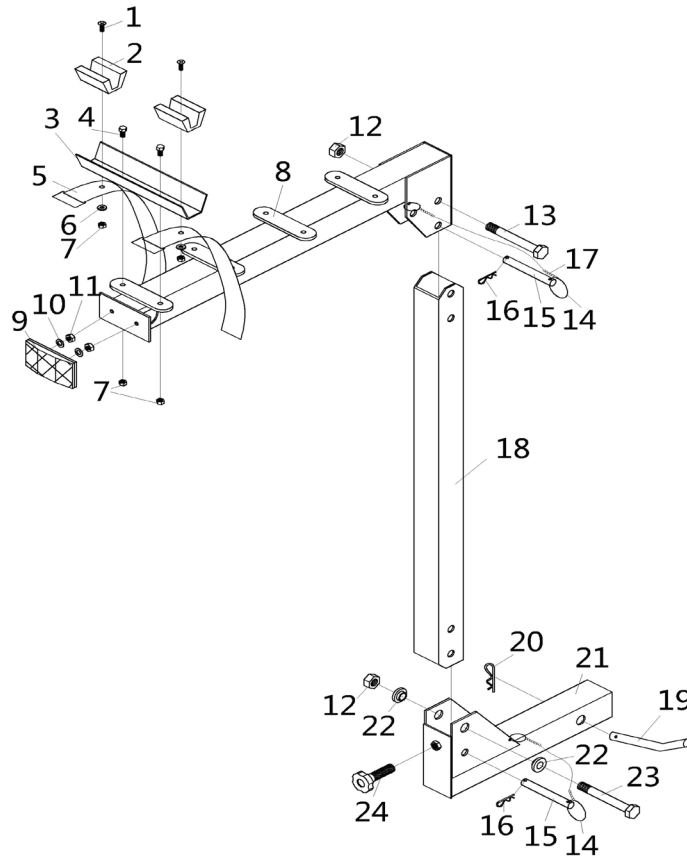

Note: The Parts List and Assembly Diagram is provided as a reference tool only. Some parts are listed and shown for illustration purposes only, and are not available as replacement parts. All repairs to this tool (including replacing parts) should only be done by a qualified service technician.

Manufactured and Distributed by:
 PGS LLC, 1270 Avenida Acaso, STE E, Acaso, STE E, CA 93012
 Tel: 805-987-1333 Fax: 805-603-1355

PGS LLC ensures complete satisfaction with this product. In the event of missing or damaged parts please call toll free, Customer service hours 9:00-5:00, Monday-Friday, PST., 1-805-987-1333