

FEATURES AND BENEFITS

KEY PARTS AND COMPONENTS

Appearance and specifications may vary without notice to improve the quality of the product.

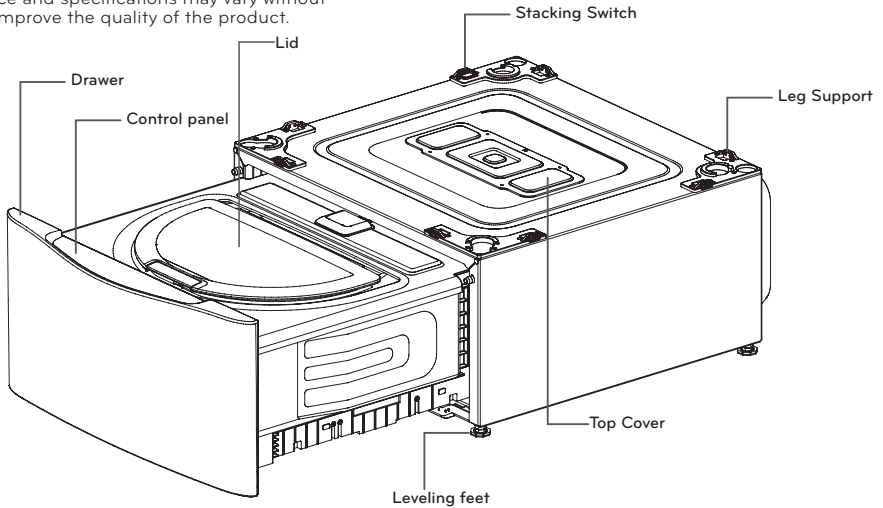

A INVERTER DIRECT DRIVE MOTOR

The inverter motor, which is directly connected to the tub, produces less noise and vibration while offering outstanding durability and a long lifespan.

B COMPACT CAPACITY & NEVERUST™ STAINLESS STEEL TUB

The efficient design provides capacity in a compact space.

C FRONT TOUCH PANEL











The simple LED display shows cycle options, setting, cycle status and estimated time remaining. The touch buttons offer more convenience and a premium design aesthetic.

D SMART DIAGNOSIS™

If you ever experience an issue with your LG washer, you don't have to worry. The SmartDiagnosis™ feature helps the service center diagnose problems over the phone, or with a simple app on your smart phone, helping you minimize costly, inconvenient service calls.

E REMOTE CONTROL RCW1

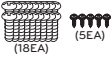
Don't want to bend down to reach the controls? Set cycles with the touch of a button on the available remote control. (Included accessory (model WD205C), or available for purchase online or through an LG retailer.)

INCLUDED ACCESSORY					REQUIRED ACCESSORY
					
2 Inlet Hoses-Short	2 Inlet Hose Y-Connectors	Drain Hose Y-Connector	Drain Hose	Non-Skid Pads	
					2 Inlet Hoses
Wrench	2 Tie Straps	2 Wire clamps and 1 Band clamp	Screws	Detergent Dispenser	

NOTE: Contact LG Customer Service at 1-800-243-0000 (1-888-542-2623 in Canada) if any accessories are missing or to purchase accessories. For a list of LG front-loading washers which are compatible with the pedestal washer, visit the LG website at www.lg.com/us/twinwash