

Please read this manual carefully before installation and keep it for future reference.

Installation Manual



MRCOOL™
COMFORT MADE SIMPLE

DIY Series

Please keep this manual where the operator can easily find it. Inside you will find helpful hints on how to use and maintain your unit properly.

For more details visit www.MrCool.com

Table of Contents

Installation Manual

0	Safety Precautions.....	4
1	Accessories	6
2	Installation Summary- Indoor Unit	8
3	Parts	10

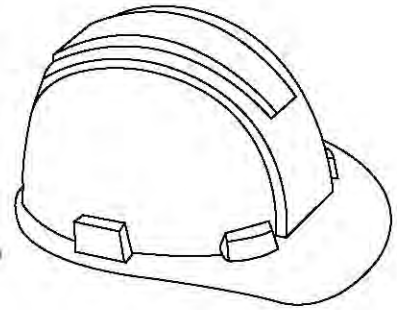

4 Indoor Unit Installation11

1. Select installation location.....11
2. Attach mounting plate to wall 12
3. Drill wall hole for connective piping12
4. Prepare refrigerant piping14
5. Connect drain hose.....15
6. Connect indoor power cable 17
7. Wrap piping and cables18
8. Mount indoor unit18

5 Outdoor Unit Installation19

1. Select installation location.....19
2. Install drain joint.....20
3. Anchor outdoor unit.....21
4. Connect signal and power cables ...22

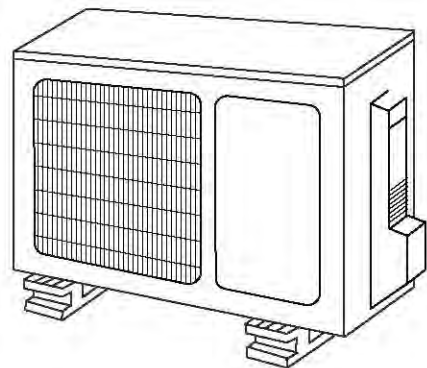

6 Refrigerant Piping Connection.....23

Connecting the refrigerant pipe to outdoor unit25

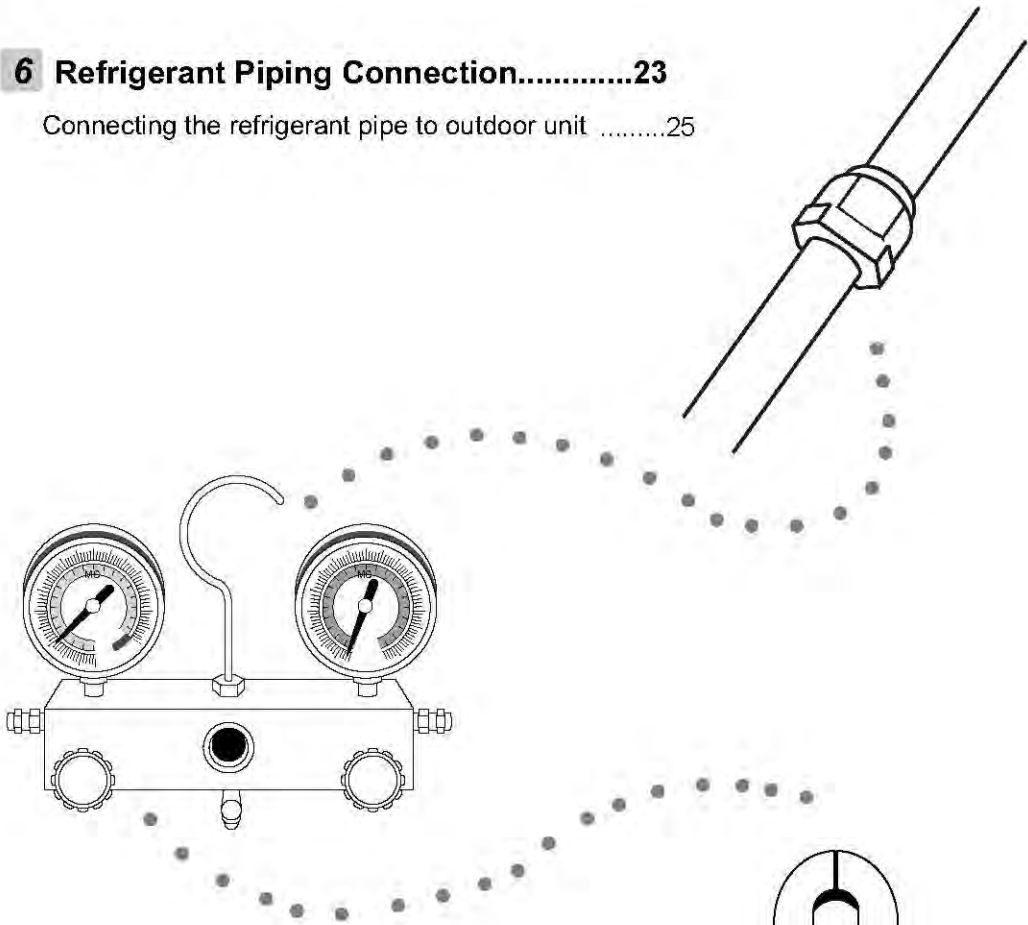

7 Electrical and Gas Leak Checks.....25

8 Test Run26

9 EU Disposal Guidelines28

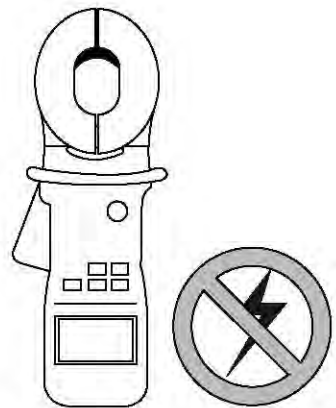

Safety Precautions

Read Before Installation

Incorrect may cause serious damage or injury.

The seriousness of potential damage or injuries is classified as either a **WARNING** or **CAUTION**.



WARNING

This symbol indicates ignoring instructions may cause death or serious injury.



CAUTION

This symbol indicates that ignoring instructions may cause moderate injury to your person, damage to your unit, or other property.



This symbol indicates that you should never perform the indicated action.



WARNING

- ⊘ **Do not** modify the length of the power supply cord or use an extension cord to power the unit. **Do not** share the electrical outlet with other appliances. Insufficient power supply may cause fire or electrical shock.
- ⊘ When connecting refrigerant piping, **do not** let substances or gases other than the specified refrigerant enter the unit. The presence of other gases or substances will decrease unit's capacity, and may cause abnormally high pressure in the operating cycle. This may cause explosion and injury.
- ⊘ **Do not** allow children to play with the air conditioner. Children should be supervised around the unit at all times.
 1. Installation must be performed by an authorized technician. Defective installation may cause water leakage, electrical shock, or fire.
 2. Installation must be performed according to installation instructions. Improper installation may cause water leakage, electrical shock, or fire.
 3. Contact an authorized service technician for repair or maintenance of the unit.
 4. Only use the included accessories, parts, and specified parts for installation. Using non-standard parts may cause water leakage, electrical shock, fire, and can cause the unit to fail.
 5. Install the unit in a firm location that can support the weight. If the installation location cannot support the weight, or the installation is performed improperly, the unit may fall and cause serious injury or damage.

WARNING

6. For all electrical work, follow all local and national wiring standards, regulations, and the Installation Manual. You must use an independent circuit and single outlet to supply power. Do not connect other appliances to the same outlet. Insufficient electrical capacity or defects in electrical work may cause electrical shock or fire.
7. For all electrical work, use the specified cables. Connect cables tightly, and clamp them securely to prevent external forces from damaging the terminal. Improper electrical connections may overheat and cause fire, or shock.
8. All wiring must be properly arranged to ensure that the control board cover can close properly. If the control board cover is not closed properly, it can lead to corrosion and cause the connection points on the terminal to overheat, catch fire, or cause electrical shock.
9. In certain functional environments, such as kitchens, server rooms, etc., the use of specially designed air-conditioning units is highly recommended.

CAUTION

- ⑦ For units that have an auxiliary electric heater, **do not** install the unit within 1 meter (3 feet) of combustible materials.
- ⑦ **Do not** install the unit in a location that may be exposed to combustible gases. If combustible gas accumulates around the unit, it may cause fire.
- ⑦ **Do not** operate your air conditioner in a wet room such as a bathroom or laundry room. Too much exposure to water may cause electrical components to short circuit.
1. The product must be properly grounded during installation, or electrical shock may occur.
2. Install drainage piping according to the instructions in this manual. Improper drainage may cause water damage to your home and property.







Note about Fluorinated Gasses



1. This air-conditioning unit contains fluorinated gases. For specific information on the type of gas and the amount, please refer to the relevant label on the unit itself.
2. Installation, service, maintenance and repair of this unit must be performed by a certified technician.
3. Product uninstallation and recycling must be performed by a certified technician.
4. If the system has a leak-detection system installed, it should be checked for leaks at least every 12 months.
5. Keep a record of all leak checks for the lifetime of the unit.

Accessories

1

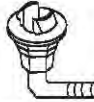
The air conditioning system comes with the following accessories. Use all of the installation parts and accessories to install the air conditioner. Improper installation may result in water leakage, electrical shock and fire, or cause the equipment to fail.

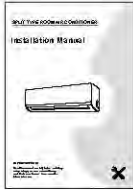
Name	Shape	Quantity
Mounting plate		1
Clip anchor		5
Mounting plate fixing screw ST3.9 X 25		5
Remote control		1
Air freshening filter		1 (used to install on the back of air filter)
Seal		1 (for cooling & heating models only)
Drain joint		

User's Manual		1
Installation Manual		1
Remote Control Manual		1

Installation Summary - Indoor Unit

2

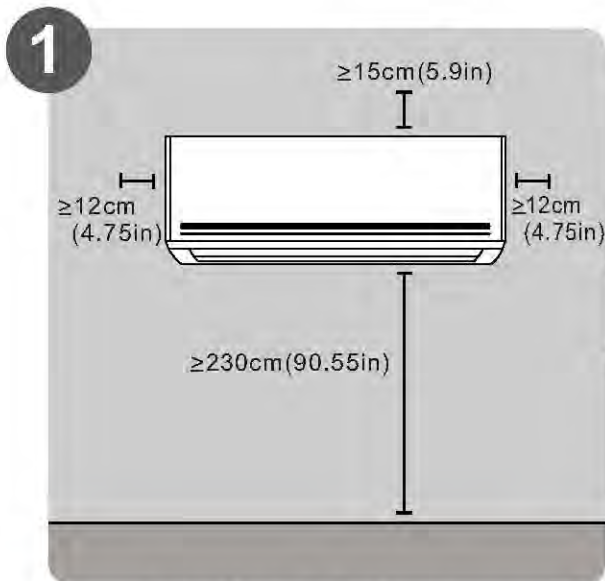

1
Select Installation Location
(Page 11)

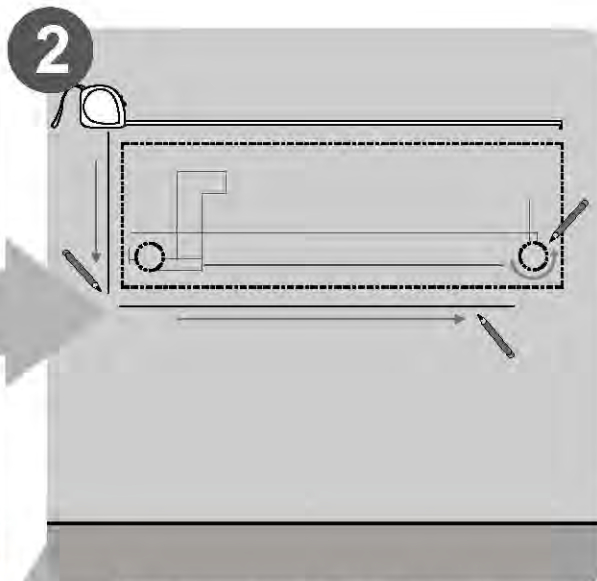

2
Determine Wall Hole Position
(Page 12)

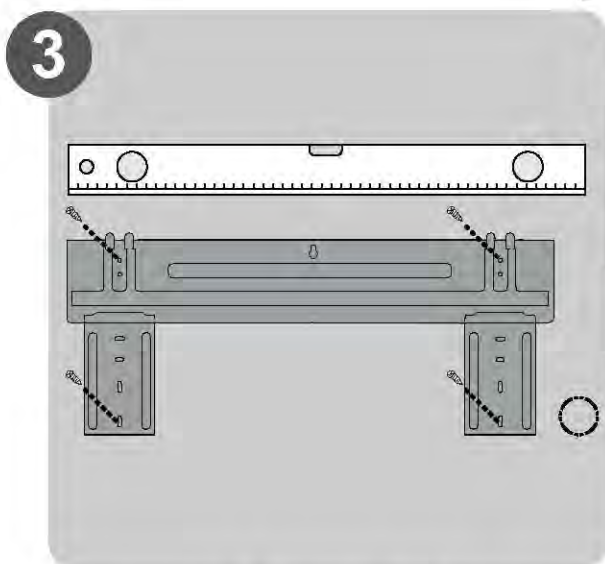

3
Attach Mounting Plate
(Page 12)

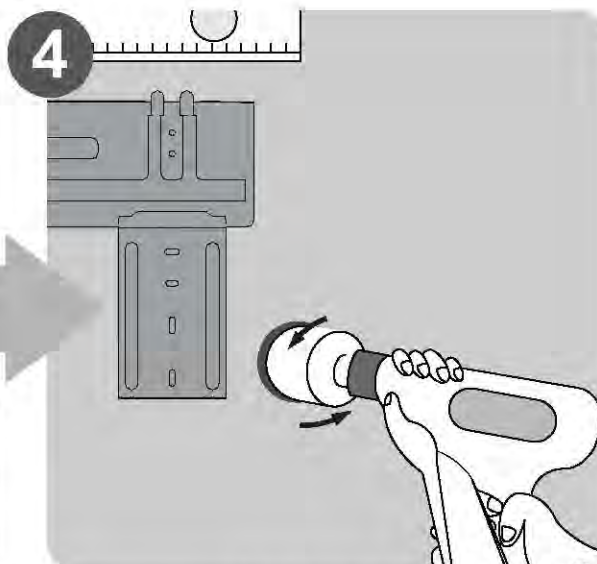

4
Drill Wall Hole
(Page 12)



5
Connect Piping
(Page 25)

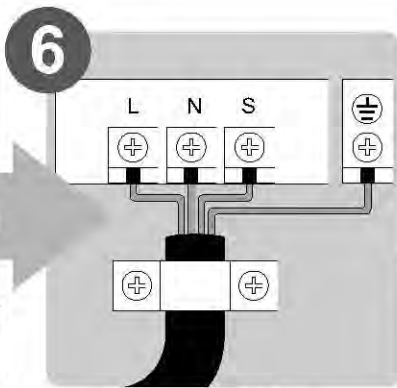

6
Connect Wiring
(Page 17)

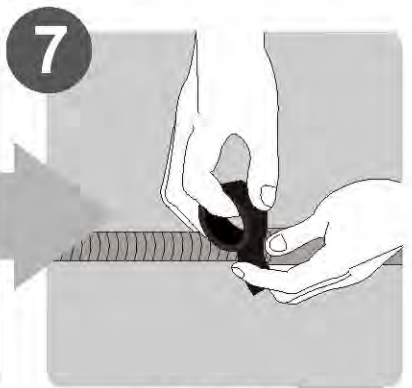

7
Prepare Drain Hose
(Page 14)

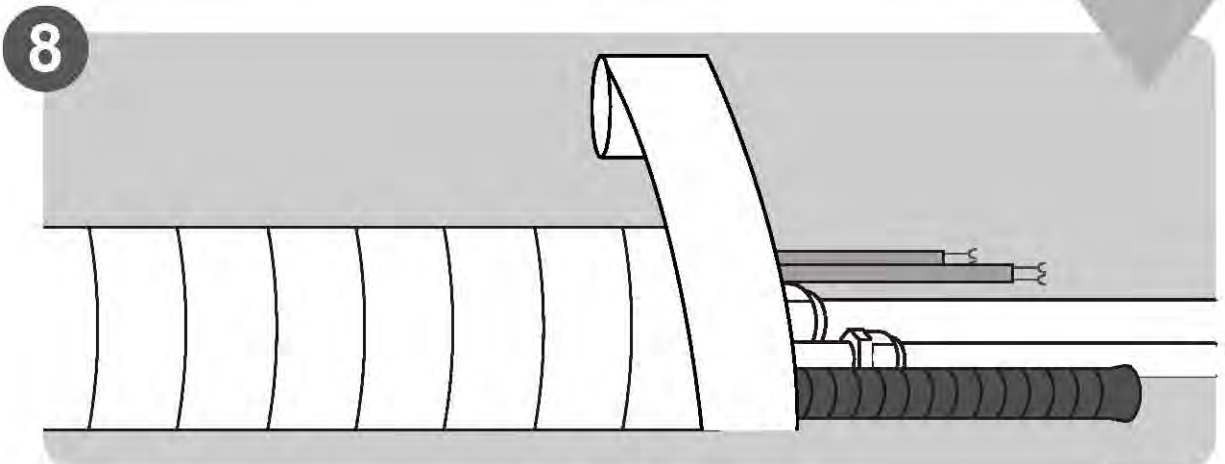

8
Wrap Piping and Cable
(Page 18)

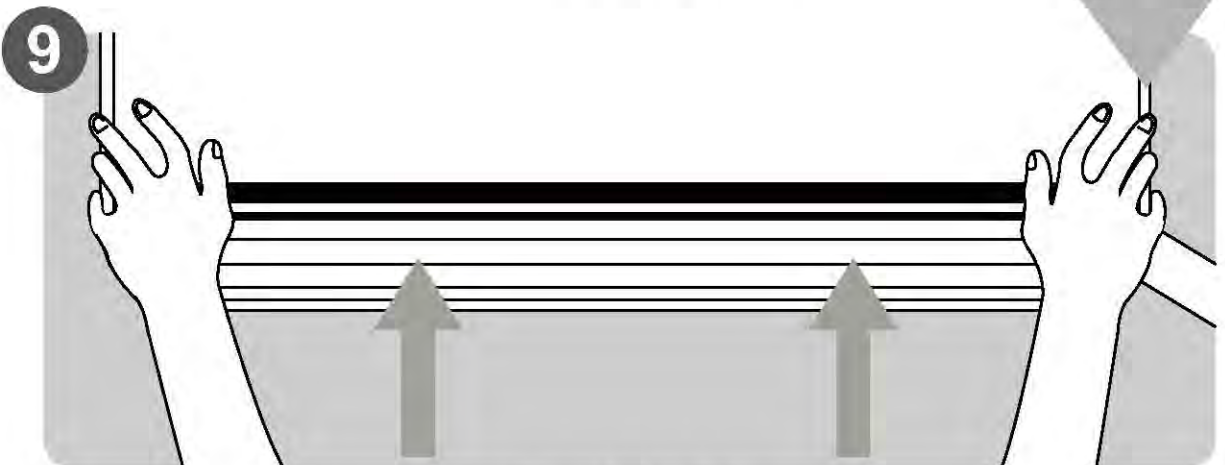

9
Mount Indoor Unit
(Page 18)

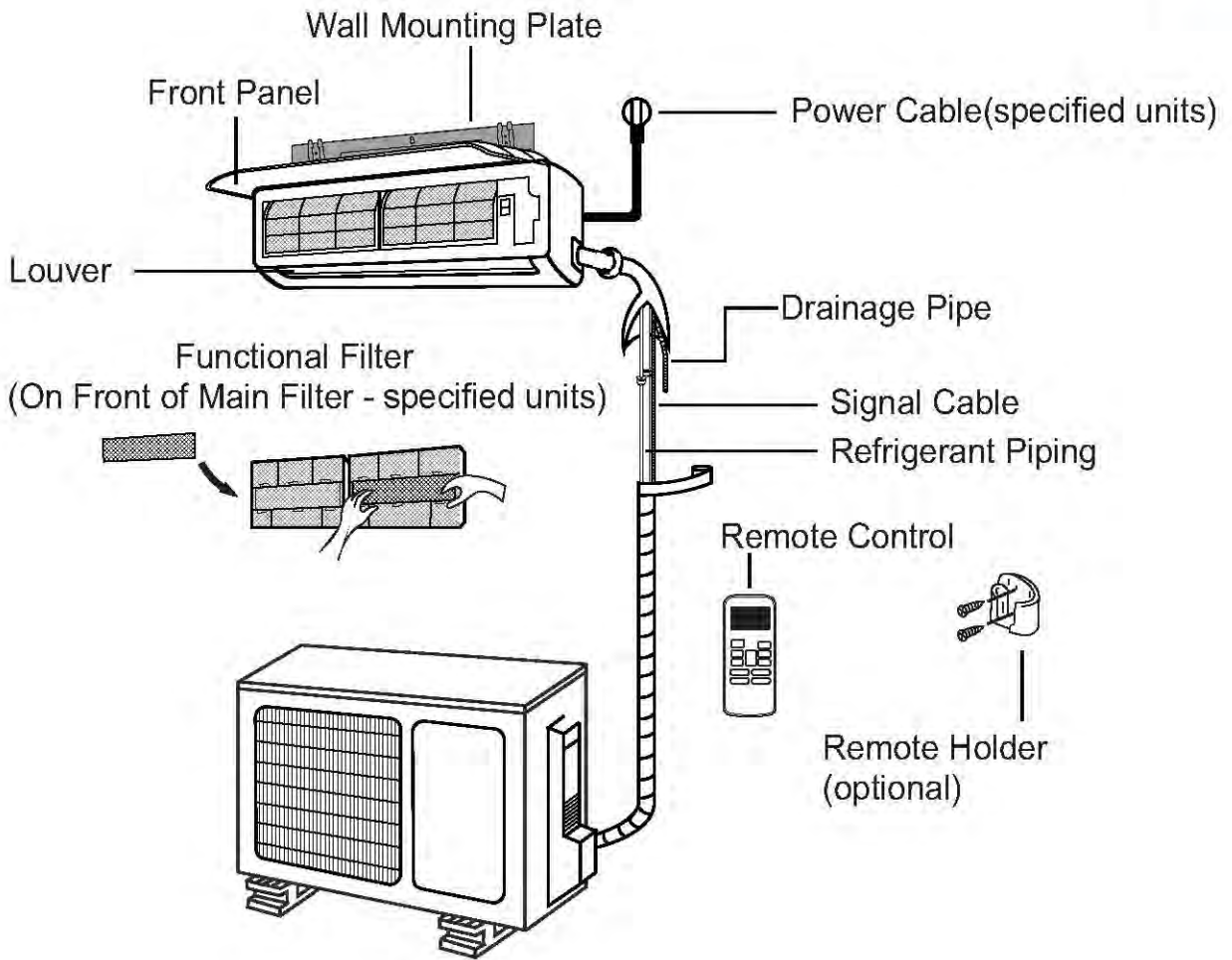

Fig. 3.1

NOTE ON ILLUSTRATIONS

Illustrations in this manual are for explanatory purposes only. The actual shape of your indoor unit may vary.

Indoor Unit Installation

4

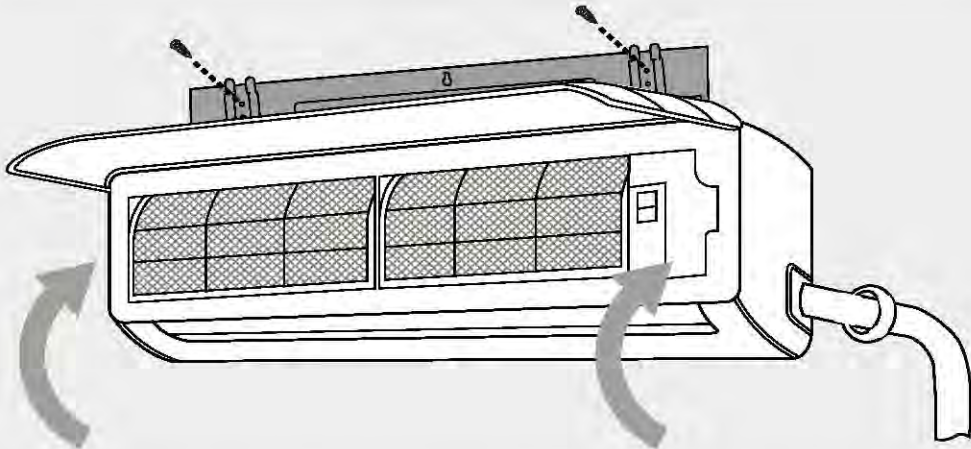

Indoor Unit
Installation

Installation Instructions - Indoor Unit

PRIOR TO INSTALLATION

Before installing the indoor unit, refer to the label on the product box to make sure that the model number of the indoor unit matches the model number of the outdoor unit.

Step 1: Select installation location

Before installing the indoor unit, you must choose an appropriate location. The following standards will help you choose an appropriate location.

Proper installation locations should meet the following standards:

- ✓ Good air circulation
- ✓ Convenient drainage
- ✓ Noise from the unit will not disturb other people
- ✓ Firm and solid—the location will not vibrate
- ✓ Strong enough to support the weight of the unit
- ✓ A location at least one meter from all other electrical devices (e.g., TV, radio, computer)

DO NOT install unit in the following locations:

- ⊘ Near any source of heat, steam, or combustible gas
- ⊘ Near flammable items such as curtains or clothing
- ⊘ Near any obstacle that might block air circulation
- ⊘ Near a doorway
- ⊘ In a location subject to direct sunlight

NOTE ABOUT WALL HOLE:

If there is no fixed refrigerant piping:

While choosing a location, be aware that you should leave ample room for a wall hole (see **Drill wall hole for connective piping step**) for the signal cable and refrigerant piping that connect the indoor and outdoor units. The default position for all piping is the right side of the indoor unit (while facing the unit). However, the unit can accommodate piping to left or right.

Refer to the following diagram to ensure proper distance from walls and ceiling:

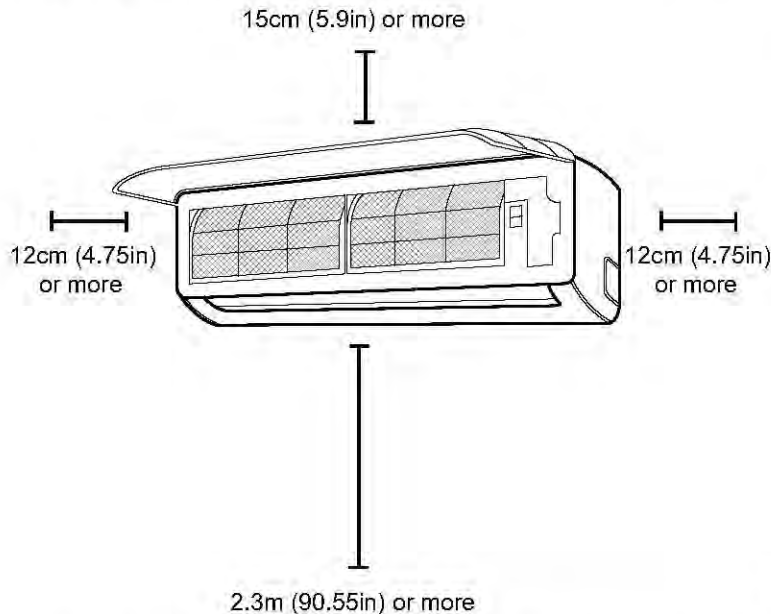

Fig. 4.1

Step 2: Attach mounting plate to wall

The mounting plate is the device on which you will mount the indoor unit.

1. Take out the mounting plate packed with the indoor unit.
2. Place the mounting plate against the wall in a location that meets the standards in the Select Installation Location step. (See **Mounting Plate Dimensions for detailed information on mounting plate sizes.**)
3. Drill holes for mounting screws in places that:
 - Have studs and can support the weight of the unit
 - Ensure the drill holes correspond to screw holes in the mounting plate
4. Secure the mounting plate to the wall with the provided screws.
5. Make sure the mounting plate is flush against the wall.

NOTE FOR CONCRETE OR BRICK WALLS:

If the wall is made of brick, concrete, or similar material, drill 5mm-diameter (0.2in-diameter) holes in the wall and insert the sleeve anchors provided. Secure the mounting plate to the wall by tightening the screws directly into the clip anchors.

Step 3: Drill wall hole for connective piping

You must drill a hole in the wall for refrigerant piping, the drainage pipe, and the signal cable that will connect the indoor and outdoor units.

1. Determine the location of the wall hole based on the position of the mounting plate. Refer to Mounting Plate Dimensions on the next page to help you determine the optimal position. The wall hole should be at least 90mm (3.54in) from the side of the unit, and at a slightly lower angle to facilitate drainage.
2. Using a 90mm (3.54in) core drill, drill a hole in the wall. Make sure that the hole is drilled at a slight downward angle, so that the outdoor end of the hole is lower than the indoor end by about 5mm to 7mm (0.2-0.275in). This will ensure proper water drainage. (See Fig. 4.2)
3. Place the protective wall cuff in the hole. This protects the edges of the hole and will help seal it when you finish the installation process.

! CAUTION

When drilling the wall hole, make sure to avoid wires, plumbing, and other sensitive components.

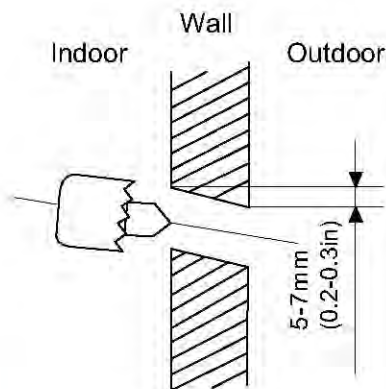
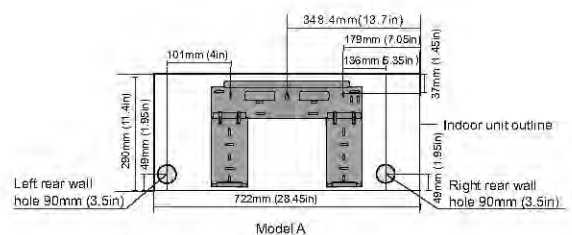
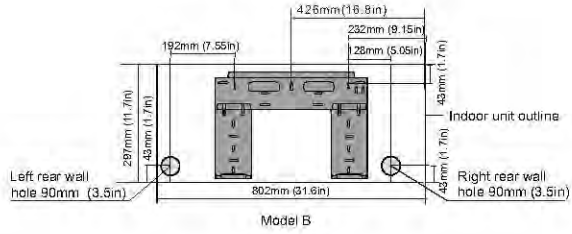

Fig. 4.2



Model A



Model B

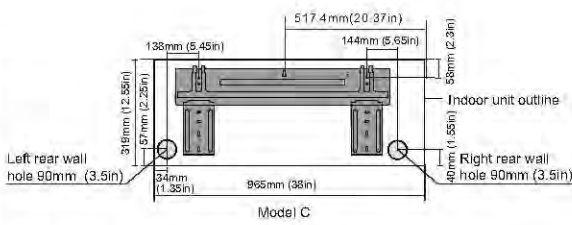

Model C

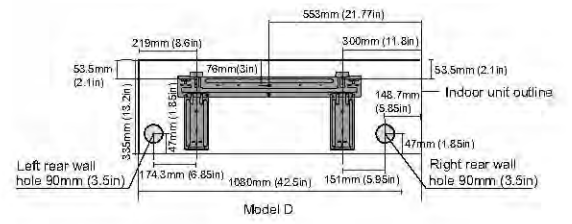

Model D

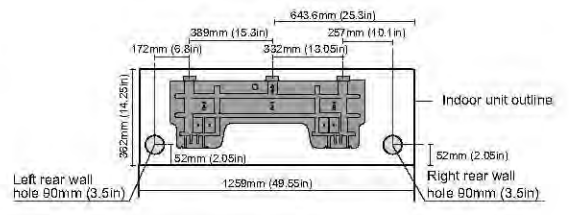

Model E

MOUNTING PLATE DIMENSIONS

Different models have different mounting plates. In order to ensure that you have ample room to mount the indoor unit, the diagrams to the right show different types of mounting plates along with the following dimensions:

- Width of mounting plate
- Height of mounting plate
- Width of indoor unit relative to plate
- Height of indoor unit relative to plate
- Recommended position of wall hole (both to the left and right of mounting plate)
- Relative distances between screw holes

Correct orientation of Mounting Plate

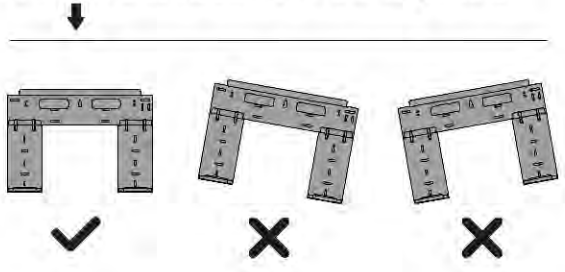

Fig. 4.3

Step 4: Prepare refrigerant piping

The refrigerant piping is inside an insulating sleeve attached to the back of the unit. You must prepare the piping before passing it through the hole in the wall. Refer to the **Refrigerant Piping Connection** section of this manual for detailed instructions on pipe flaring and flare torque requirements, technique, etc.

1. Based on the position of the wall hole relative to the mounting plate, choose the side from which the piping will exit the unit.
2. Connect the indoor refrigerant piping to the connective piping that will join the indoor and outdoor units.
3. Based on the position of the wall hole relative to the mounting plate, determine the necessary angle of your piping.
4. Grip the refrigerant piping at the base of the bend.
5. Slowly, with even pressure, bend the piping towards the hole. **Do not** dent or damage the piping during the process.

NOTE ON PIPING ANGLE

Refrigerant piping can exit the indoor unit from two different angles:

- Left-hand side
- Right-hand side

Refer to **Fig. 4.4** for details.

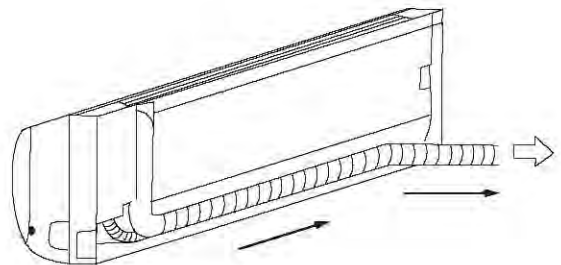
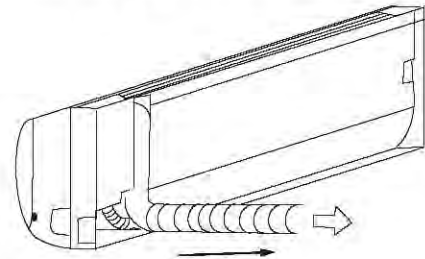

Fig. 4.4

Indoor Unit
Installation



! CAUTION

Be extremely careful not to dent or damage the piping while bending them away from the unit. Any dents in the piping will affect performance.

Step 5: Connect drain hose

By default, the drain hose is attached to the left-hand side of unit (when you're facing the back of the unit).

1. To ensure proper drainage, attach the drain hose on the same side that your refrigerant piping exits the unit.
2. Attach drain hose extension (purchased separately) to the end of drain hose.
3. Wrap the connection point firmly with Teflon tape to ensure a good seal and to prevent leaks.
4. For the portion of the drain hose that will remain indoors, wrap it with foam pipe insulation to prevent condensation.
5. Remove the air filter and pour a small amount of water into the drain pan to make sure that water flows from the unit smoothly.

NOTE ON DRAIN HOSE PLACEMENT

Make sure to arrange the drain hose according to **Fig. 4.5**.

- ⊘ **DO NOT** kink the drain hose.
- ⊘ **DO NOT** create a water trap.
- ⊘ **DO NOT** put the end of drain hose in water or a container that will collect water.

PLUG THE UNUSED DRAIN HOLE

To prevent leaks you must plug the excess space in the drain hole with the rubber plug.

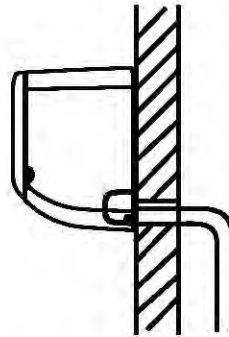

Fig.4.5

CORRECT

Make sure there are no kinks or dent in the drain hose to ensure proper drainage.

NOT CORRECT

Kinks in the drain hose will create water traps.

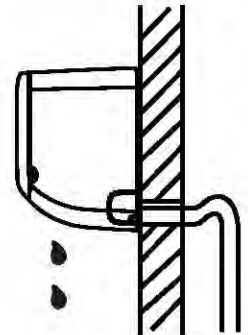

Fig. 4.6

NOT CORRECT

Dents in the drain hose will create water traps.

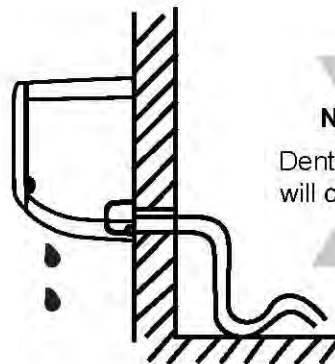

Fig. 4.7

NOT CORRECT

Do not place the end of the drain hose in water or in containers that collect water. This will prevent proper drainage.

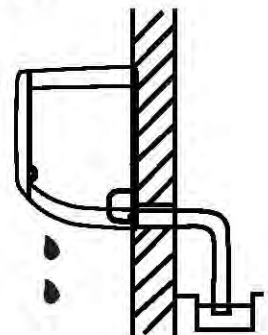

Fig. 4.8



BEFORE PERFORMING ELECTRICAL WORK, READ THESE REGULATIONS

1. All wiring must comply with local and national electrical codes, and must be installed by a licensed electrician.
2. All electrical connections must be made according to the Electrical Connection Diagram located on the panels of the indoor and outdoor units.
3. If there is a serious safety issue with the power supply, stop work immediately. Explain your reasoning to the client, and refuse to install the unit until the safety issue is properly resolved.
4. Power voltage should be within 90-100% of rated voltage. Insufficient power supply can cause malfunction, electrical shock, or fire.
5. If connecting power to fixed wiring, install a surge protector and main power switch with a capacity 1.5 times the maximum unit current.
6. If connecting power to fixed wiring, a switch or circuit breaker that disconnects all poles and has a contact separation of at least 1/8in (3mm) must be incorporated in the fixed wiring. Use an approved circuit breaker or switch.
7. Only connect the unit to an individual branch circuit outlet. Do not connect another appliance to that outlet.
8. Make sure to properly ground the air conditioner.
9. Every wire must be firmly connected. Loose wiring can cause the terminal to overheat, resulting in malfunction and possible fire.
10. Do not let wires touch or rest against refrigerant tubing, the compressor, or any moving parts within the unit.
11. If the unit has an auxiliary electric heater, it must be installed at least 1 meter (40in) away from combustible materials.



WARNING

BEFORE PERFORMING ANY ELECTRICAL OR WIRING WORK, TURN OFF THE MAIN POWER TO THE SYSTEM.

Step 6: Connect indoor power wire

The cable enables communication between the indoor and outdoor units. You must first choose the right cable size before preparing it for connection.

Cable Types

- **Indoor Power Cable (if applicable):** H05VV-F or H05V2V2-F
- **Outdoor Power Cable:** H07RN-F
- **Signal Cable:** H07RN-F

Minimum Cross-Sectional Area of Power and Signal Cables

North America

Appliance Amps (A)	AWG
10	18
13	16
18	14
25	12
30	10

Other Regions

Rated Current of Appliance (A)	Nominal Cross Sectional Area (mm ²)
> 3 and ≤ 6	0.75
> 6 and ≤ 10	1.0
> 10 and ≤ 16	1.5
> 16 and ≤ 25	2.5
> 25 and ≤ 32	4
> 32 and ≤ 40	6

CHOOSE THE RIGHT CABLE SIZE

The size of the power supply cable, signal cable, fuse, and switch needed is determined by the maximum current of the unit. The maximum current is indicated on the nameplate located on the side panel of the unit. Refer to this nameplate to choose the right cable, fuse, or switch.

TAKE NOTE OF FUSE SPECIFICATIONS

The air conditioner's circuit board (PCB) is designed with a fuse to provide overcurrent protection. The specifications of the fuse are printed on the circuit board, such as: T3.15A/250VAC, T5A/250VAC, etc.

1. Prepare the cable for connection:

Hold the indoor plug connector and insert the mating plug connector located on the outdoor unit until it fixed with a clicking sound. The Y/G wire should be connected individually. Secure the cable onto the control board with the cord clamp. See Fig.4.9 for example:

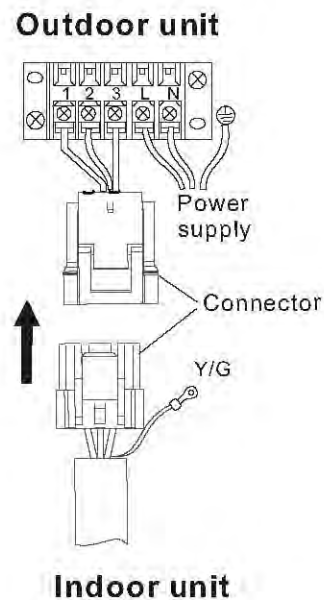

Fig. 4.9

NOTE ABOUT WIRING

THE WIRING CONNECTION PROCESS MAY DIFFER SLIGHTLY BETWEEN UNITS

WARNING

ALL WIRING MUST PERFORMED STRICTLY IN ACCORDANCE WITH THE WIRING DIAGRAM LOCATED ON THE INSIDE OF THE INDOOR UNIT'S WIRE COVER.



NOTE ABOUT WIRING

THE WIRING CONNECTION PROCESS MAY DIFFER SLIGHTLY BETWEEN UNITS

Step 7: Wrap piping and cables

Before passing the piping, drain hose, and the signal cable through the wall hole, you must bundle them together to protect them, insulate them, and save space.

1. Bundle the drain hose, refrigerant pipes, and signal cable according to Fig. 4.10.

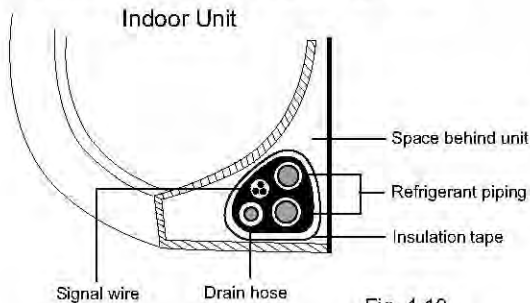

Fig. 4.10

DRAIN HOSE MUST BE ON BOTTOM

Make sure that the drain hose is at the bottom of the bundle. Putting the drain hose at the top of the bundle can cause the drain pan to overflow, which may lead to fire or water damage.

DO NOT INTERTWINE SIGNAL CABLE WITH OTHER WIRES

While bundling these items together, do not intertwine or cross the signal cable with any other wiring.

2. Using adhesive vinyl tape, attach the drain hose to the underside of the refrigerant pipes.
3. Using insulation tape, wrap the signal wire, refrigerant pipes, and drain hose tightly together. Double-check that all items are bundled in accordance with Fig. 4.10

DO NOT WRAP ENDS OF PIPING

When wrapping the bundle, keep the ends of the piping unwrapped. You need to access them to test for leaks at the end of the installation process (refer to **Electrical Checks and Leak Checks** section of this manual).

Step 8: Mount indoor unit

If you installed new connective piping to the outdoor unit, do the following:

1. If you have already passed the refrigerant piping through the hole in the wall, proceed to Step 4.
2. Otherwise, double-check that the ends of the refrigerant pipes are sealed to prevent dirt or foreign material from entering the pipes.
3. Slowly pass the wrapped bundle of refrigerant pipes, drain hose, and signal wire through the hole in the wall.
4. Hook the top of the indoor unit on the upper hook of the mounting plate.
5. Check that the unit is hooked firmly on the mounting plate by applying slight pressure to the left and right-hand sides of the unit. The unit should not jiggle or shift.
6. Using even pressure, push down on the bottom half of the unit. Keep pushing down until the unit snaps onto the hooks along the bottom of the mounting plate.
7. Again, check that the unit is firmly mounted by applying slight pressure to the left and the right-hand sides of the unit.

Outdoor Unit Installation

5

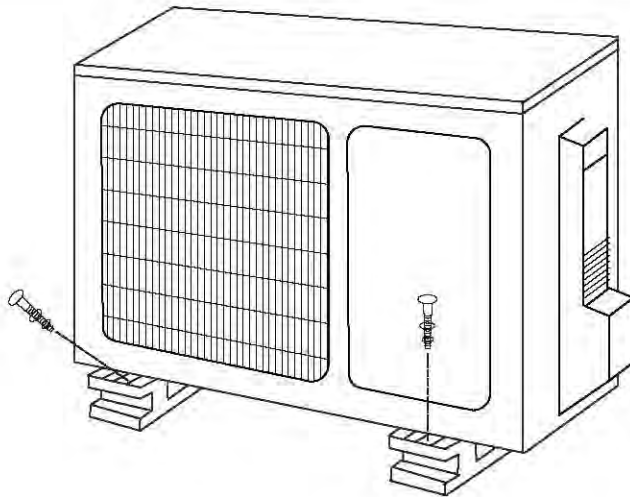

Outdoor Unit
Installation

Installation Instructions- Outdoor Unit

Step 1: Select installation location

Before installing the outdoor unit, you must choose an appropriate location. The following standards will help you choose an appropriate location.

Proper installation locations meet the following standards:

- ✓ Meets all spatial requirements shown in Installation Space Requirements (Fig. 4.1)
- ✓ Good air circulation and ventilation
- ✓ Firm and solid location that can support the unit and will not cause vibration
- ✓ Noise from the unit will not disturb others
- ✓ Protected from prolonged periods of direct sunlight or rain

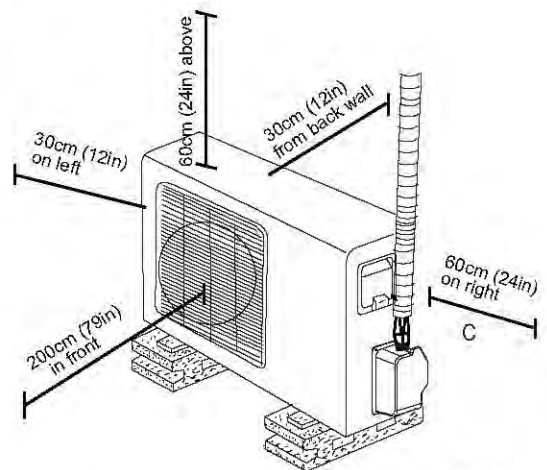

Fig. 5.1

DO NOT install unit in the following locations:

- ⊘ Near an obstacle that will block air inlets and outlets
- ⊘ Near a public street, crowded areas, or where noise from the unit will disturb others
- ⊘ Near animals or plants that will be harmed by hot air discharge
- ⊘ Near any source of combustible gas
- ⊘ In a location that is exposed to large amounts of dust
- ⊘ In a location exposed to a excessive amounts of salty air

SPECIAL CONSIDERATIONS FOR EXTREME WEATHER

If the unit is exposed to heavy wind:

Install unit so that air outlet fan is at a 90° angle to the direction of the wind. If needed, build a barrier in front of the unit to protect it from extremely heavy winds.

See Fig. 4.2 and Fig. 4.3 below.

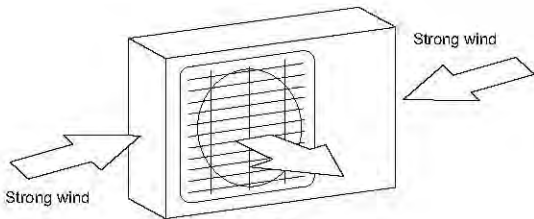

Fig. 4.2

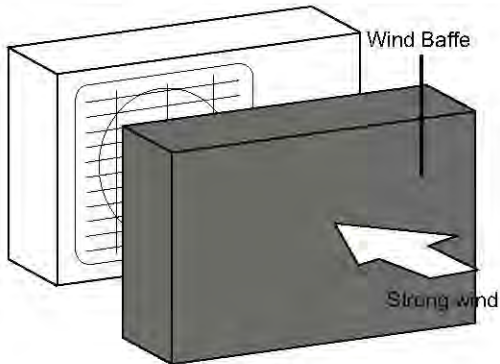

Fig. 4.3

If the unit is frequently exposed to heavy rain or snow:

Build a shelter above the unit to protect it from the rain or snow. Be careful not to obstruct air flow around the unit.

If the unit is frequently exposed to salty air (seaside):

Use an outdoor unit that is specially designed to resist salt corrosion.

Step 2: Install drain joint

Heat pump units require a drain joint. Before bolting the outdoor unit in place, you must install the drain joint at the bottom of the unit. Note that there are two different types of drain joints depending on the type of outdoor unit.

If the drain joint comes with a rubber seal (see Fig. 4.4 - A), do the following:

1. Fit the rubber seal on the end of the drain joint that will connect to the outdoor unit.
2. Insert the drain joint into the hole in the base pan of the unit.
3. Rotate the drain joint 90° until it clicks in place facing the front of the unit.
4. Connect a drain hose extension (not included) to the drain joint to redirect water from the unit during heating mode.

If the drain joint doesn't come with a rubber seal (see Fig. 4.4 - B), do the following:

1. Insert the drain joint into the hole in the base pan of the unit. The drain joint will click in place.
2. Connect a drain hose extension (not included) to the drain joint to redirect water from the unit during heating mode.

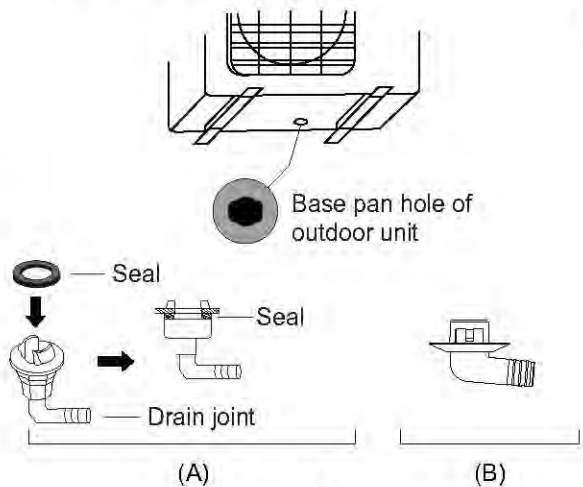

Fig. 4.4

! IN COLD CLIMATES

In cold climates, make sure that the drain hose is as vertical as possible to ensure swift water drainage. If water drains too slowly, it can freeze in the hose and flood the unit.

Step 3: Anchor outdoor unit

The outdoor unit can be anchored to the ground or to a wall-mounted bracket.

UNIT MOUNTING DIMENSIONS

The following is a list of different outdoor unit sizes and the distance between their mounting feet. Prepare the installation base of the unit according to the dimensions below.

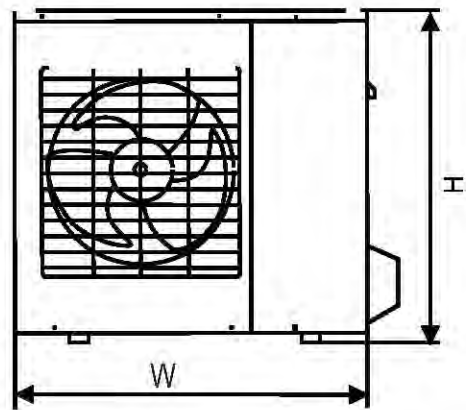
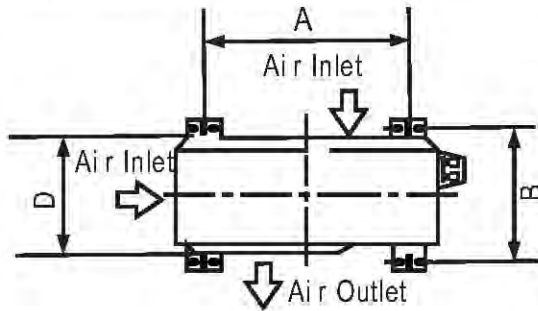

Fig. 4.5

Outdoor Unit Dimensions (mm)	Mounting Dimensions	
	W x H x D	Distance A (mm)
685x430x260 (27"x17"x10.25")	460 (18.10")	276 (10.85")
700x540x240 (27.5"x21.25"x9.45")	458 (18")	250 (9.85")
780x540x250 (30.7"x21.25"x9.85")	549 (21.6")	276 (10.85")
760x590x285 (29.9"x23.2"x11.2")	530 (20.85")	290 (11.4")
845x700x320 (33.25"x27.5"x12.6")	560 (22")	335 (13.2")
810x558x310 (31.9"x22"x12.2")	549 (21.6")	325 (12.8")
900x860x315 (35.4"x33.85"x12.4")	590 (23.2")	333 (13.1")
945x810x395 (37.2"x31.9"x15.55")	640 (25.2")	405 (15.95")

If you will install the unit on the ground or on a concrete mounting platform, do the following:

1. Mark the positions for four expansion bolts based on dimensions in the Unit Mounting Dimensions chart.
2. Pre-drill holes for expansion bolts.
3. Clean concrete dust away from holes.
4. Place a nut on the end of each expansion bolt.
5. Hammer expansion bolts into the pre-drilled holes.
6. Remove the nuts from expansion bolts, and place outdoor unit on bolts.
7. Put washer on each expansion bolt, then replace the nuts.
8. Using a wrench, tighten each nut until snug.

! WARNING

WHEN DRILLING INTO CONCRETE, EYE PROTECTION IS RECOMMENDED AT ALL TIMES.

If you install the unit on a wall-mounted bracket, do the following:

! CAUTION

Before installing a wall-mounted unit, make sure that the wall is made of solid brick, concrete, or of similarly strong material. **The wall must be able to support at least four times the weight of the unit.**

1. Mark the position of bracket holes based on dimensions in the Unit Mounting Dimensions chart.
2. Pre-drill the holes for the expansion bolts.
3. Clean dust and debris away from holes.
4. Place a washer and nut on the end of each expansion bolt.
5. Thread expansion bolts through holes in mounting brackets, put mounting brackets in position, and hammer expansion bolts into the wall.
6. Check that the mounting brackets are level.
7. Carefully lift unit and place its mounting feet on brackets.
8. Bolt the unit firmly to the brackets.

TO REDUCE VIBRATIONS OF WALL-MOUNTED UNIT

If allowed, you can install the wall-mounted unit with rubber gaskets to reduce vibrations and noise.

Step 4: Connect signal and power cables

The outside unit's terminal block is protected by an electrical wiring cover on the side of the unit. A comprehensive wiring diagram is printed on the inside of the wiring cover.

BEFORE PERFORMING ELECTRICAL WORK, READ THESE REGULATIONS

1. All wiring must comply with local and national electrical codes, and must be installed by a licensed electrician.
2. All electrical connections must be made according to the Electrical Connection Diagram located on the side panels of the indoor and outdoor units.
3. If there is a serious safety issue with the power supply, stop work immediately. Explain your reasoning to the client, and refuse to install the unit until the safety issue is properly resolved.
4. Power voltage should be within 90-100% of rated voltage. Insufficient power supply can cause electrical shock or fire.
5. If connecting power to fixed wiring, install a surge protector and main power switch with a capacity of 1.5 times the maximum current of the unit.
6. If connecting power to fixed wiring, a switch or circuit breaker that disconnects all poles and has a contact separation of at least 1/8in (3mm) must be incorporated in the fixed wiring. The qualified technician must use an approved circuit breaker or switch.
7. Only connect the unit to an individual branch circuit outlet. Do not connect another appliance to that outlet.
8. Make sure to properly ground the air conditioner.
9. Every wire must be firmly connected. Loose wiring can cause the terminal to overheat, resulting in product malfunction and possible fire.
10. **Do not** let wires touch or rest against refrigerant tubing, the compressor, or any moving parts within the unit.
11. If the unit has an auxiliary electric heater, it must be installed at least 1 meter (40in) away from any combustible materials.

Refrigerant Piping Connection

Connecting the refrigerant pipe to outdoor unit

CAUTION: For your safety, always wear goggles and work gloves when connecting the pipes.

NOTE: To distinguish the connectors to be connected to the indoor unit and outdoor unit, the connectors of the refrigerant pipe has been labelled "A", "B", "C" and "D". Ensure the marks on the connector are the same to the indoor's and outdoor's respectively during connection.

1. First remove the water tray on the outdoor unit as shown in Fig.6.1.

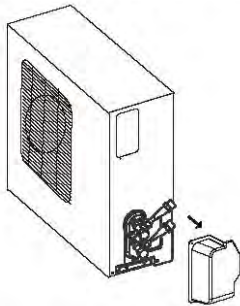

Fig.6.1

2. Do not remove the plastic seals from the outdoor unit and the appropriate refrigerant pipes until immediately before you connect them, Fig.6.2



Fig.6.2

3. Align the refrigerant pipes correctly so that they line up with the valves and are not stressed. Place the screw connector on the refrigerant line just on to the thread on the outdoor unit and tighten the first few threads by hand, Fig.6.3.

NOTE: The refrigerant pipes must be connected to the valves on the outdoor unit with as little stress as possible.

IMPORTANT: Before you continue, it is essential that you read the following instructions carefully.



Fig.6.3

4. Now tighten the bottom screw connector first and then the top screw connector using the open-ended spanner. Hold the points marked "①" using an open-ended spanner and turn the nuts only at the points marked "②" using an open-ended spanner (Select the appropriate spanner according to the dimensions of the connector), see Fig.6.4

- Ensure that the screw connectors do not skew as you tighten them and work quickly. See the next page for the proper torque.

IMPORTANT: Since the coupling works with tapping rings, it may leak if you undo and reconnect the pipes. This will also void the warranty.

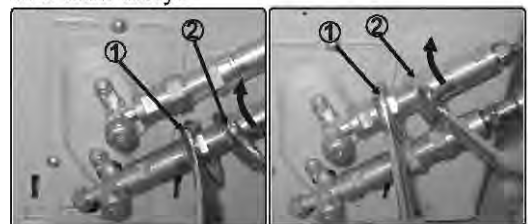

Fig.6.4

Coupling size (last 2 part numbers)	Pound-force foot(1bf-ft)	Newton meter(N-m)	Kilogram-force meter(kgf-m)
-06(9.5mm dash size)	18 - 20	24.4 - 27.1	2.4 - 2.7
-08(12.7mm dash size)	30 - 35	40.6 - 47.4	4.1 - 4.8
-12(19.1mm dash size)	45 - 50	61.0 - 67.7	6.2 - 6.9
-16(25.4mm dash size)	60 - 65	81.3 - 88.1	8.2 - 8.9

After completing steps 1- 4, check that all the connections are sealed correctly using leak detection spray or soap suds. If any bubbles form, the system has a leak and the screw connectors must be retightened using an open-ended spanner.

- Now remove the cover on the top valve using a 19 mm open-ended spanner. Open the valve by turning it counter-clockwise as far as it will go using a 5 mm Allen key. The valve is now open. If the valve is not opened fully, the system may malfunction and suffer damage. Screw the cover back on to the top valve and tighten it well to ensure that it is properly sealed. See Fig.6.5.

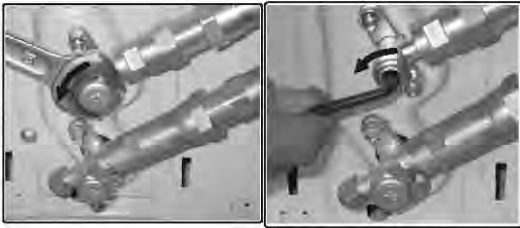

Fig.6.5

- Now remove the cover on the bottom valve using a 19 mm open-ended spanner. Open the valve by turning it counter-clockwise as far as it will go using a 5 mm Allen key. The valve is now open. If the valve is not opened fully, the system may malfunction and suffer

Damage. Screw the cover back on to the bottom valve and tighten it well to ensure that it is properly sealed. See Fig.6.6.

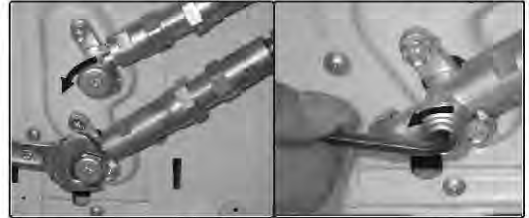

Fig.6.6

Important! The conical ring on the valve has an important sealing function together with the sealing seat in the caps. Ensure that you do not damage the cone and that you keep the cap free of dirt and dust.

- After completing steps 1- 6, check that all the connections are sealed correctly using leak detection spray or soap suds. If any bubbles form, the system has a leak and the screw connectors must be retightened using an open- ended spanner.
- Start the equipment so that the operating pressures build up inside it. Check all the connectors again for signs of leaks
 - during cooling mode
 - in heating mode.
 If any bubbles form, the system has a leak and the screw connectors must be retightened using an open-ended spanner.

Electrical and Gas Leak Checks

7



Electrical Safety Checks

After installation, confirm that all electrical wiring is installed in accordance with local and national regulations, and according to the Installation Manual.

BEFORE TEST RUN

Check Grounding Work

Measure grounding resistance by visual detection and with grounding resistance tester. Grounding resistance must be less than 4.

Note: This may not be required for some locations in the US.

DURING TEST RUN

Check for Electrical Leakage

During the Test Run, use an electroprobe and multimeter to perform a comprehensive electrical leakage test.

If electrical leakage is detected, turn off the unit immediately and call a licensed electrician to find and resolve the cause of the leakage.

Note: This may not be required for some locations in the US.

! WARNING - RISK OF ELECTRIC SHOCK

ALL WIRING MUST COMPLY WITH LOCAL AND NATIONAL ELECTRICAL CODES, AND MUST BE INSTALLED BY A LICENSED ELECTRICIAN.

Gas Leak Checks

There are two different methods to check for gaseous leaks.

Soap and Water Method

Using a soft brush, apply soapy water or liquid detergent to all pipe connection points on the indoor unit and outdoor unit. The presence of bubbles indicates a leak.

Leak Detector Method

If using leak detector, refer to the device's operation manual for proper usage instructions.

AFTER PERFORMING GAS LEAK CHECKS

After confirming that the all pipe connection points DO NOT leak, replace the valve cover on the outside unit.

Test Run

8

Before Test Run

Only perform test run after you have completed the following steps:

- **Electrical Safety Checks** - Confirm that the unit's electrical system is safe and operating properly.
- **Gas Leak Checks** - Check all flare nut connections and confirm that the system is not leaking.
- Confirm that gas and liquid (high and low pressure) valves are fully open.

Test Run Instructions

You should perform the Test Run for at least 30 minutes.

1. Connect power to the unit.
2. Press the **ON/OFF** button on the remote controller to turn it on.
3. Press the **MODE** button to scroll through the following functions, one at a time:
 - COOL - Select lowest possible temperature
 - HEAT - Select highest possible temperature
4. Let each function run for 5 minutes, and perform the following checks:

List of Checks to Perform	PASS/FAIL	
No electrical leakage		
Unit is properly grounded		
All electrical terminals properly covered		
Indoor and outdoor units are solidly installed		
All pipe connection points do not leak	Outdoor (2):	Indoor (2):
Water drains properly from drain hose		
All piping is properly insulated		
Unit performs COOL function properly		
Unit performs HEAT function properly		
Indoor unit louvers rotate properly		
Indoor unit responds to remote controller		

DOUBLE-CHECK PIPE CONNECTIONS

During operation, the pressure of the refrigerant circuit will increase. This may reveal leaks that were not present during your initial leak check. Take time during the Test Run to double-check that all refrigerant pipe connection points do not have leaks. Refer to **Gas Leak Check** section for instructions.

5. After the Test Run is successfully complete, and you confirm that all checks points in List of Checks to Perform have PASSED, do the following:
 - a. Using remote control, return unit to normal operating temperature.
 - b. Using insulation tape, wrap the indoor refrigerant pipe connections that you left uncovered during the indoor unit installation process.

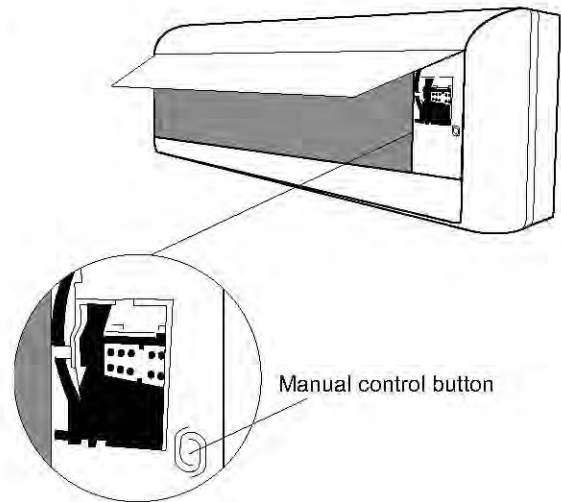

Fig.8.1

IF AMBIENT TEMPERATURE IS BELOW 63°F

You can't use the remote control to turn on the COOL function when the ambient temperature is below 17°C. In this instance, you can use the **MANUAL CONTROL** button to test the COOL function.

1. Lift the front panel of the indoor unit, and raise it until it clicks in place.
2. The **MANUAL CONTROL** button is located on the right-hand side of the unit. Press it 2 times to select the COOL function. See **Fig.8.1**.
3. Perform Test Run as normal.

EU Disposal Guidelines

9

This appliance contains refrigerant and other potentially hazardous materials. When disposing of this appliance, the law requires special collection and treatment. **Do not** dispose of this product as household waste or unsorted municipal waste.

When disposing of this appliance you have the following options:

- Dispose of the appliance at a designated municipal electronic waste collection facility.
- When buying a new appliance, the retailer will receive the old appliance free of charge.
- The manufacturer will receive the old appliance free of charge.
- Sell the appliance to a certified scrap metal dealers.

Special notice

Disposing of this appliance in the forest or other natural surroundings endangers your health and is bad for the environment. Hazardous substances may leak into the ground water and enter the food chain.





MRCOOL™
COMFORT MADE SIMPLE

DIY Series

The design and specifications are subject to change without prior notice.
Consult with the sales agency or manufacturer for details.