

# SINKOLOGY™

## Installation Guide

Install your new sink with step-by-step instructions.

# Installation Guide

## Bath Sinks

Drop-In .....	4
Undermount .....	6
Dual Flex .....	9
Vessel .....	10
Drains .....	12

## Bathtubs

Freestanding .....	16
Overflow and Waste Kit .....	18
Rough-In Kit .....	20

## Kitchen + Bar Sinks

Drop-In .....	24
Undermount .....	28
Farmhouse .....	30
Drains .....	36
Fireclay .....	40



Bath Sinks

## Bath Sinks: Drop-In



Drop-In sinks are designed to be easy to install in a wide range of countertop materials. Sinkology copper sinks make updating your bathroom design effortless.

### Important

Sinkology bathroom drop-in sinks do not use mounting hardware. Our preferred mounting method requires expanding foam and 100% silicone to secure your copper sink into place.

1. Flip sink upside down and trace outside edge onto craft paper or cardboard. Add a second line 1/2" inch inside the first line. Cut out the center of the template using the second line.
2. Place the template on the countertop and trace the template. Cut the installation hole in the countertop.
3. Position the sink in the hole and check for gaps around the rim. Eliminate gaps by gently tapping the rim with a rubber mallet.
4. Weigh the sink down and apply polyurethane expanding foam underneath the sink to seal the gap between the sink and the

countertop to secure the sink in place.

5. Use plumbers putty on the underside of the drain lip to seal the drain to the sink. See *diagram*.
6. Apply Sinkology antique brown or clear neutral cure 100% silicone around the rim of the sink to form a water tight seal. See our Complete Silicone Installation Kit (#SINSTALL-101) for Copper Sinks.
7. For regular maintenance simply wash with gentle soap and water. For extra protection against water spotting, use Sinkology Copper Armor care kit (#SARMOR-101) or high quality carnauba wax.

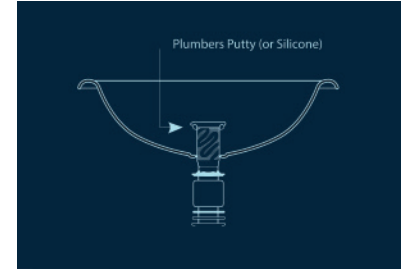



## Bath Sinks: Undermount

Undermount sinks are the ideal choice for a clean high-end look with granite or solid surface countertops. This installation maximizes countertop space and highlights the elegance of your countertop.

### Important

Sinkology undermount sinks do not include mounting hardware. We recommend providing your sink details to your countertop manufacturer for approved mounting hardware and method.

1. Flip sink upside down on a sheet of craft paper or cardboard and trace the outside rim of the sink. Select preferred countertop offset. See *diagram*. Measure the distance between the edge of the basin and the inside edge of the lip. Add a second line inside the first according to this measurement. Cut out the template along the second line.

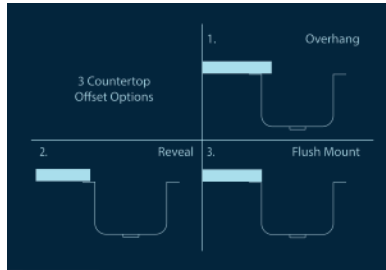

2. Place the template onto the countertop and cut the hole into the countertop.

3. Use clear or Sinkology antique brown neutral cure 100% silicone (#SINSTALL-101) on the rim of the sink. Mount sink under the countertop using approved countertop mounting hardware. See *diagram*. Sinkology does not provide under mounting hardware due to the wide variety of mounting surfaces which require specific hardware. Contact your countertop manufacturer for specific mounting hardware.

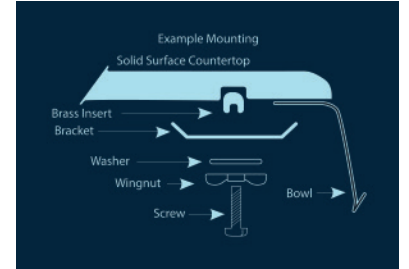

4. Slide the drain through the drain hole in the basin. Use plumbers putty on the underside of the drain lip to seal the drain assembly to the sink and clean off and excess. See *diagram*.

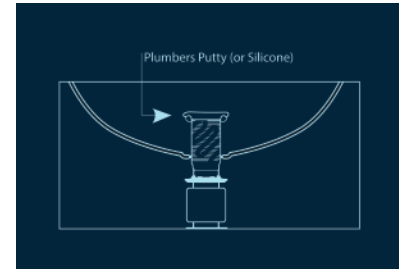

## Bath Sinks: Undermount (*continued*)

5. To complete your install we recommend applying a thin bead of Sinkology antique brown or clear neutral cure 100% silicone to any gaps between sink and countertop.
6. For regular maintenance simply wash with gentle soap and water. For extra protection against water spotting, use Sinkology Copper Armor care kit (#SARMOR-101) or high quality carnauba wax.

## Bath Sinks: Dual Flex

Copper sinks featuring our exclusive Dual Flex rim are approved for undermount or drop-in applications. The Dual Flex rim features a flat undermount rim with slight bend allowing for functional and beautiful drop-in or undermount installation.



### **Important**

Dual Flex copper sinks can be identified by their unique rim design. A Dual Flex rim will have a flat undermounting surface and a decorative curved edge.

Please reference your preferred installation methods instructions:

Bath Sinks: Drop-In                      Page 4

Bath Sinks: Undermount                Page 6

## Bath Sinks: Vessel



Vessel sinks are an easy way to add character and style to any bathroom. Vessel sinks install directly on top of your countertop and are reminiscent of old wash basins. This unique and luxurious sink style is easy to install and are available in a wide variety of styles and finishes.

### Important

Sinkology copper vessel sinks are designed to be installed securely in a 2-3/4" inch hole in the countertop. Sinkology does NOT recommend vessel mounting rings.

1. Flip sink upside down and trace outside edge onto craft paper or cardboard. Mock up any plumbing connections and faucet placement to ensure necessary clearances. Cut out template and place on the countertop. Mark the center location of the sink on the countertop.
2. Drill a 2 3/4" inch diameter hole in your countertop at the center mark. A 1/8th inch beveled edge is recommended, but not necessary. See *diagram*.

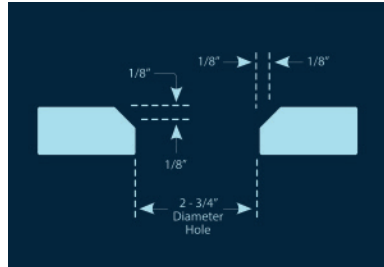

3. Apply Sinkology antique brown or clear neutral cure 100% silicone (#SINSTALL-101) to the edge of the hole and mount sink into place. Apply plumbers putty on the underside of the drain lip and assemble the drain.
4. Place the large steel mounting washer over the drain pipe and tighten the brass locknut until the steel washer is firmly attached to the underside of the countertop, holding the entire sink in place. See *diagram*.
5. For a professional look add a bead of Sinkology antique brown or clear neutral cure 100% silicone around the base of the sink.
6. For regular maintenance simply wash with gentle soap and water. For extra protection against water spotting, use Sinkology Copper Armor care kit (#SARMOR-101) or high quality carnauba wax.

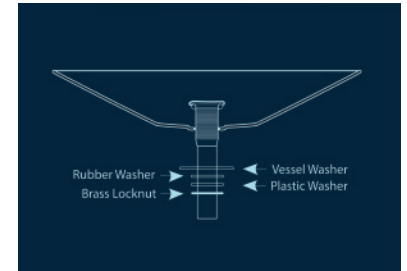

## Bath Sink: Drains



Sinkology bathroom sink drains are constructed of solid brass and hand finished to complement Sinkology bathroom sinks. Sinkology grid and pop-up bath sink drains work with most standard No-Overflow sinks and are protected by a Lifetime Warranty.

### Important

Sinkology bath drains feature a no-overflow design and should only be installed into bathroom sinks without overflow holes. If your sink has an overflow, you will need to purchase an overflow sink drain, available at most retailers. See *diagram*.

1. Wash and dry the sink and the drain.
2. Remove lock nut, rubber washer and white plastic washer from drain stem.
3. Apply plumbers putty on the underside of the drain lip and slide the drain into sink

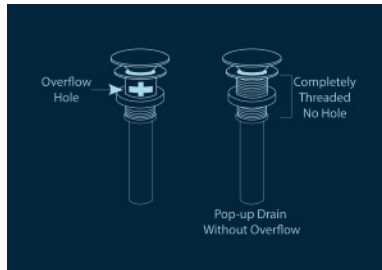

drain hole. The drain and the metal of the sink will be touching with a thin layer of plumbers putty creating a water tight seal around the drain. Wipe off excess plumbers putty, it could stain your copper sink.

4. If you do not have a vessel sink, skip to Step 5. If you have a Sinkology copper vessel sink you should have received a large steel washer with your sink. This washer slides up the drain pipe first.
5. Slide the rubber washer onto the drain stem until up against bottom of sink or vessel washer. Slide on white washer then locknut onto threads until drain is tight and secure.
6. Test all connections for leaks.



## Bathtubs





## Bathtubs: Freestanding

Every Sinkology copper bathtub is skillfully hand-hammered and carefully finished by our team of coppersmiths. Each bathtub is hand-tested multiple times to ensure no leaks and perfect performance.

### **Important**

Sinkology copper bathtubs are handmade so variations in dimensions can occur. We recommend performing rough-in procedures with the bathtub on site to ensure the correct installation.

1. Gather the products being installed and the tools you will need. It's easier to install your drain and faucet before placing the tub.
2. Install the drain and overflow drains onto the bathtub per the drain and overflow kit instructions.
3. Install the faucet per the manufacturer's instructions.
4. Place bathtub in desired location and mark exact location on the floor.
5. Run the drain pipes through the floor and attach to the plumbing. This step is best handled by a professional.
6. Once placement is final, apply Sinkology antique brown or clear neutral cure 100% silicone (#SINSTALL-101) caulk around the tub. Allow the caulk to set for 24-hours (or timing per the manufacturer's instructions) before using your copper tub.



## Bathtubs: Drain + Overflow Kit

Bathtub drain and overflow kits feature a durable and beautiful custom bronze finish designed to look and work beautifully with Sinkology freestanding copper bathtubs.

### Important

Sinkology copper bathtubs are handmade so variations in dimensions can occur. We recommend performing rough-in procedures with the bathtub on site to ensure the correct installation.

1. Loosely assemble selected freestanding bathtub waste drain or overflow kit onto bathtub (leaving off the tailpipes at this time).
2. Determine water line locations for selected bathtub filler. Tub faucet may need to be assembled prior to tub installation.
3. Place bathtub in final location and mark exact location on the floor.
4. Rough-In final plumbing waste drain and water lines into proper locations. We recommend using OS&B (#ITD35) rough-in kit. This kit is designed to work with most freestanding bathtubs and

makes plumbing rough-in fast and easy, and ensures a watertight connection. See *diagram*.

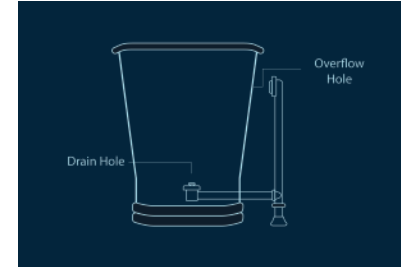



## Bathtubs: Rough-In Waste Drain

The copper bathtub rough-in kit not only makes installation easier, but it saves time and money. Designed to work specifically with Sinkology copper bathtubs, and is protected by a Lifetime Warranty.

### Important

Sinkology copper bathtubs are handmade so variations in dimensions can occur. We recommend performing rough-in procedures with the bathtub on site to ensure the correct installation.

1. Final waste drain and waterline rough-in's should be completed and flooring should be finished. Ensure bathtub is properly supported and level.
2. Double check bathtub faucet installation requirements before final bath tub installation.
3. Apply thread sealant or plumbers tape to any threaded connections that do not have rubber gaskets.
4. Apply plumbers putty to underside of drain flange and thread through the bathtub and into drain pipe.
5. Ensure waste drain and overflow is securely connected to bathtub.
6. Place tub back into desired location and verify that bathtub is level. If using recommended rough-in kit (#ITD35), the tub will need to be lifted approximately 8" before lowering into final position.
7. Finish installation by running a bead of silicone adhesive around the base of copper freestanding bathtub where applicable to create a watertight seal.
8. Allow sealants and adhesive to thoroughly dry before filling bathtub with water. Consult sealant and adhesive manufacturers for dry times, as they may vary.

## Kitchen & Bar Sinks



# Kitchen & Bar Sinks: Drop-In



Drop-in kitchen sinks are easy to install and are designed to install beautifully in a wide range of countertop surfaces. Sinkology Drop-In kitchen sinks make DIY kitchen renovations effortless and impactful. Drop-In sinks can be used to replace an old sink or installed in luxurious new countertops.

### Important

Not all Drop-In kitchen sinks require mounting hardware. If your kitchen sink does not come with mounting brackets, we recommend securing your sink with 100% silicone and expandable foam (see bath sink drop-in instructions on page 4)

1. Flip sink upside down and trace the outside edge onto craft paper or cardboard. Add a second line that is 1/2" inch inside that line. Cut out the traced template using the second line.
2. Position the template flat on the countertop and align with cabinet and plumbing connections.
3. Mark openings and cut the countertop.

4. Always double check the sink for fit inside the hole before moving on.
5. If your sink does not come with mounting hardware, refer to bath sink drop-in installation instructions on page 4.
6. Before dropping your new sink into the countertop for the last time apply a thick bead of Sinkology antique brown or clear neutral cure 100% silicone around the hole on the countertop to form a water tight seal around the sink. See our Complete Silicone Installation Kit (#SINSTALL-101) for Copper Sinks.
7. Install hardware. Place notched end of all bolts into the keyhole slots. See *diagram*. Lower the sink carefully into the countertop so the bolts enter without interference.

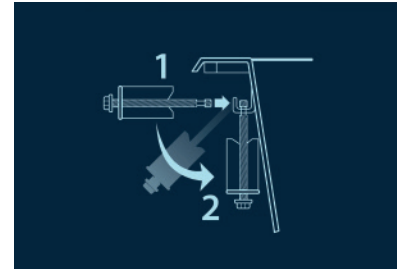

## Kitchen & Bar Sinks: Drop-In (continued)

8. Turn the claws out 90 degrees so they will grasp the underside of the countertop. See *diagram*.

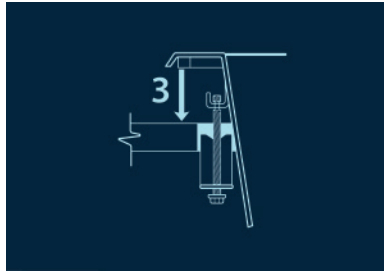

9. Claws can be bent to accommodate larger or smaller gaps. Tighten the clamps evenly until all of the clamps grasp the underside of the countertop firmly and securely.

10. Some Sinkology copper sinks feature rear deck brackets that are designed for hardware with two claws per bolt. First claw closest to bracket bolt tip will sit against the underneath of the sink rim. Second claw will be used to grab underneath the countertop. See *diagram*.

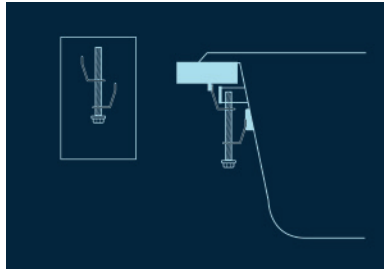

11. Install drains.
12. For a professional look apply a thin bead of Sinkology antique brown or clear neutral cure 100% silicone around the rim.
13. For regular maintenance simply wash with gentle soap and water. For extra protection against water spotting, use Sinkology Copper Armor care kit (#SARMOR-201) or high quality carnauba wax.



## Kitchen & Bar Sinks: Undermount

Undermount kitchen sinks are recommended when installing new granite or solid surface countertops. Undermount installation adds a luxurious and professional look to kitchen design and maximizes countertop space. By installing your Sinkology kitchen sink undercounter it makes wiping countertops easy and helps during kitchen clean up.

### Important

Sinkology undermount kitchen sinks do not include mounting hardware. We recommend providing your sink details to your countertop manufacturer for approved mounting hardware and method.

1. Flip sink upside down on a sheet of craft paper or cardboard and trace the outside rim of the sink. Select preferred countertop offset. See *diagram*. Measure the distance between the edge of the basin and the inside edge of the lip. Add a second line inside the first according to this measurement. Cut out the template along the second line.

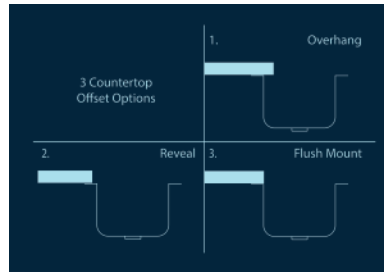

2. Place the template onto the countertop and cut the hole into the countertop.
3. Use clear or Sinkology antique brown neutral cure 100% silicone (#SINSTALL-101) on the rim of the sink. Mount sink under the countertop using mounting hardware. Sinkology does not provide under mounting hardware due to the wide variety of mounting surfaces which require specific hardware. Contact your countertop manufacturer for specific mounting hardware.
4. Ensure sink is mounted flat against countertop on all sides, adjust hardware as needed.
5. Use plumbers putty to install the drain. Clean excess.
6. To complete your install we recommend applying a thin bead of Sinkology antique brown or clear neutral cure 100% silicone to any gaps between sink and countertop.
7. For regular maintenance simply wash with gentle soap and water. For extra protection against water spotting, use Sinkology Copper Armor care kit (#SARMOR-101) or high quality carnauba wax.





## Kitchen Farmhouse Sinks: Undermount

Farmhouse kitchen sinks are the ultimate kitchen design element. Sinkology apron front kitchen sinks are design to be highly functional yet make a bold statement. The apron front design and large spacious bowl make kitchen clean up more comfortable.

### Important

Most Sinkology farmhouse kitchen sinks can be installed as an undermount or drop-in. We recommend undermount installation with new granite or solid surface countertops.

Farmhouse sinks require extra installation steps, we recommend using professional tools and professional experience when installing farmhouse copper sinks. Occasionally the cabinet face front and countertop will be cut to accommodate apron front sinks. Undermount farmhouse sinks require additional support to hold sink in place.

1. Flip sink upside down on a piece of craft paper or cardboard and trace the edge of the basin. Measure the distance between the edge of the basin and the inside edge of the lip. Add a second line inside the first according to this measurement. Cut on the second line to make your cut out template. The apron

front is designed to extend past the front of the cabinet. Take this measurement before making any cuts. When you make your cut out measurements, accommodate the apron extending past the cabinet front.

2. Cut the countertop and cabinet front to accommodate the sink basin using your cut out template.
3. Build a support ledge for your sink. Screw three lengths of 2x4's (depends on cabinet width) along the back and both sides of cabinet. Sink is fully supported when  $\frac{3}{4}$ " inch of rim is supported on three sides. If additional support is needed four vertical 2x4 supports can be installed. See *diagram*.

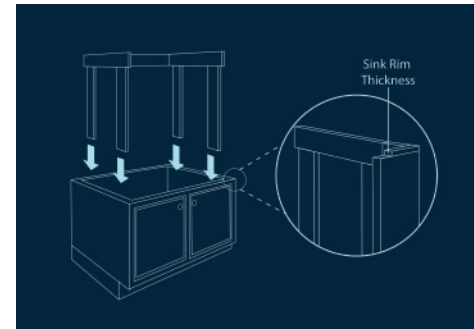

## Kitchen Farmhouse Sinks: Undermount (*continued*)

---

4. Ensure top sink rim rests 1/8" inch below top of cabinet frame when supported and in place.
5. Countertops will be placed directly on top of cabinet and sink. Farmhouse sink typically needs to be fully in place before countertop templating can begin.
6. Install the countertop. Apply thin bead of Sinkology antique brown or clear neutral cure 100% silicone into any gaps between sink and countertop. See our Complete Silicone Installation Kit (#SINSTALL-101) for Copper Sinks.
7. For regular maintenance simply wash with gentle soap and water. For extra protection against water spotting, use Sinkology Copper Armor care kit (#SARMOR-201) or high quality carnauba wax.



## Kitchen Farmhouse Sinks: Drop-In

Farmhouse apron front kitchen sinks are a great centerpiece to any kitchen. Our farmhouse sinks can be dropped in to existing countertop and cabinets with a simple DIY project to make your kitchen the envy of friends and family.

### Important

Most Sinkology farmhouse kitchen sinks can be installed as an undermount or drop-in. If your sink has 1/2" inch rim or less, it was designed for undermount installation only.

1. Flip sink upside down on a piece of craft paper or cardboard and trace the edge of the basin. Add a second line approx. 3/4" inch inside that line. Cut out the traced template using the second line. Note: The apron front is designed to extend past the front of the cabinet. Take this measurement before making any cuts. When you make your cut out measurements, accommodate the apron extending past the cabinet front.
2. Cut the countertop and cabinet front to accommodate the sink basin using your cut out template.
3. Often cabinet doors need to be modified to allow for extra-large Sinkology farmhouse copper sinks.

4. Sinkology farmhouse sinks are considered fully support when 3/4" inch or more of the rim is supported on three sides.

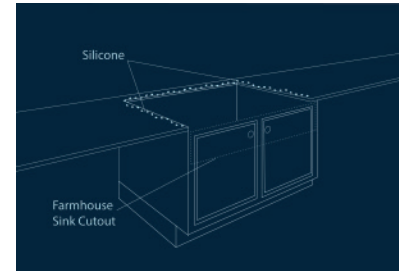

5. Apply a thick bead of Sinkology clear or antique brown neutral cure 100% silicone around the edge of the countertop and install sink. Wipe off excess silicone. See our Complete Silicone Installation Kit (#SINSTALL-101) for Copper Sinks. See *diagram*.
6. Allow silicone 24-48 hours to cure before using sink.
7. For a professional look apply a thin bead of Sinkology antique brown or clean neutral cure 100% silicone around the edge of your sink and countertop.
8. For regular maintenance simply wash with gentle soap and water. For extra protection against water spotting, use Sinkology Copper Armor care kit (#SARMOR-201) or high quality carnauba wax.

Sinkology drains are designed to perfectly complement Sinkology copper sinks. Sinkology kitchen drains are designed to fit any standard drain hole. Sinkology disposal flanges are designed for InSinkErator disposals.

### Important

Sinkology disposal flanges are designed for use only with InSinkErator disposals. If you have questions regarding drains, please contact [customerservice@sinkology.com](mailto:customerservice@sinkology.com) for assistance.

## Disposal Flange

1. Our disposal flange is designed to only work with InSinkErator disposals. Follow the InSinkErator instructions to install the disposal to the flange.

2. Apply plumbers putty around the underside of the outer drain flange lip and place it in the drain hole in the sink. The metal flange will sit directly on the metal sink. *See diagram.*

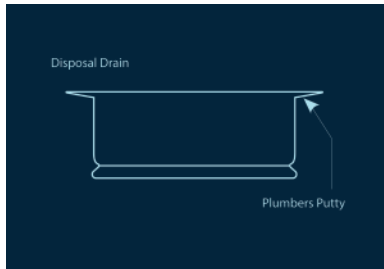

3. Wipe away excess plumbers putty around the rim of the drain.

## Basket Strainer

1. Unscrew the locking nut and washer from the drain flange.

2. Apply plumbers putty around the underside of the outer drain flange lip and place it in the drain hole in the sink. The metal flange will sit directly on the metal sink. Clean any excess. *See diagram.*

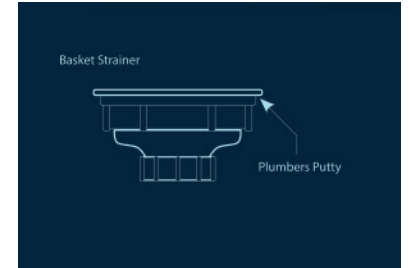

3. Place the rubber washer on the large metal nut and screw the nut on to the drain underneath the sink.
4. Wipe away any excess plumbers putty around the rim of the drain.

## Fireclay Sinks





## Kitchen: Fireclay Sinks

Fireclay sinks are distinct and ready for heavy duty use. Fireclay is coated in a high strength glaze which is resistant to scratches and stains. Fireclay is a very dense material which makes each sink hard to chip as well as very heavy. We recommend using at least two people when lifting the sink. Fireclay sinks will require extra support and modification to existing cabinets.

### Important

Sinkology Fireclay sinks require a solid support built into the cabinet and recommend professional installation. We recommend an undermount install with a frame supporting the underside of the sink.

1. Trace the rim of the sink on a piece of craft paper or cardboard. Measure the distance between the edge of the basin and the inside edge of the lip. Add a second line inside the first according to this measurement. Cut on the second line to make your cut out sheet.
2. Measure the front apron of the sink and cut the face of the cabinet to allow the sink to slide in.
3. Install the sink support in the cabinet base. See steps 4 - 6.
4. Install two lengths of 2x4's front to back in the cabinet base. Build out the support structure and ledge for your Fireclay sink to rest on.
5. Install a length of 2x4 vertically under each corner of the sink base to create support legs directly under the sink.
6. The sink should rest 1/8" inch below the top of your cabinets, ensuring plenty of clearance for countertop installation. Use a level to make sure the sink is even and will drain correctly.
7. Place the sink in the support structure. Apply a bead of silicone sealant between the rim of the sink and the countertop to create a watertight seal. Hook up the drain underneath according to the drain instructions and the sink will be ready for use. **DO NOT** overtighten your disposal drain, this could damage your kitchen sink. Use plumbers putty to make a water tight seal between the drain and the sink.
8. Cut the countertop with your template and install the countertop. Apply a bead of silicone sealant between the rim of the sink and the countertop to create a watertight seal.

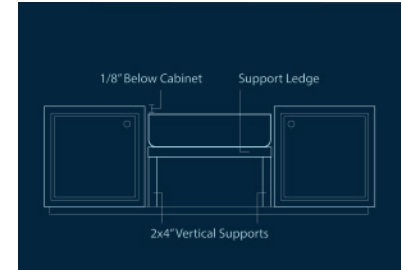

SINKOLOGY.COM

