

# EJ212

## Electric Jack 1 Ton (2,000 lbs)

### Assembly & Operating Instructions



READ ALL INSTRUCTIONS AND WARNINGS BEFORE USING THIS PRODUCT.

This manual provides important information on proper operation & maintenance. Every effort has been made to ensure the accuracy of this manual. These instructions are not meant to cover every possible condition and situation that may occur. We reserve the right to change this product at any time without prior notice.

IF THERE IS ANY QUESTION ABOUT A CONDITION BEING SAFE OR UNSAFE, DO NOT OPERATE THIS PRODUCT!

HAVE QUESTIONS OR PROBLEMS? DO NOT RETURN THIS PRODUCT TO THE RETAILER - CONTACT BUFFALO TOOLS.

If you experience a problem or need parts for this product, visit our website <http://www.buffalotools.com> or call our customer help line at **1-888-287-6981, Monday-Friday, 8 AM - 4 PM Central Time**. A copy of the sales receipt is required.

FOR CONSUMER USE ONLY - NOT FOR PROFESSIONAL USE.

KEEP THIS MANUAL, SALES RECEIPT & APPLICABLE WARRANTY FOR FUTURE REFERENCE.

## EJ212 Electric Jack 1 Ton (2,000 lbs)



### FEATURES:

- 1 Ton Max Load Capacity (2,000 lbs) Max
- 2-Button Push Button Controller with 12 Ft Cord

### SPECIFICATIONS

Operating Voltage 12V DC  
Working Current <10 Amps  
Lift Height 8.6 inches –13.3 inches MAX (4.75 inches minimum height)

**FOR CONSUMER USE ONLY – NOT FOR PROFESSIONAL USE**

# TABLE OF CONTENTS

## GENERAL SAFETY RULES

RECOGNIZE SAFETY SYMBOLS, WORDS AND LABELS.....	4
IMPORTANT SAFETY INSTRUCTIONS.....	5
WORK AREA.....	5
TOOL USE & CARE .....	5
SERVICE.....	6

## SPECIFIC SAFETY RULES AND/OR SYMBOLS

SYMBOLS .....	6
---------------	---

## FUNCTIONAL DESCRIPTION

PACKAGE CONTENTS.....	6
COMPONENTS LIST .....	7

## OPERATION

OPERATION .....	8
-----------------	---

## MAINTENANCE

MAINTENANCE .....	8
-------------------	---

## ACCESSORIES

ACCESSORIES.....	8
------------------	---

# GENERAL SAFETY RULES FOR ALL ELECTRIC POWER TOOLS

## **WARNING**

READ AND UNDERSTAND ALL INSTRUCTIONS. Failure to follow all instructions listed below may result in electric shock, fire and/or serious personal injury.

## RECOGNIZE SAFETY SYMBOLS, WORDS AND LABELS

### What You Need to Know About Safety Instructions

Warning and Important Safety Instructions appearing in this manual are not meant to cover all possible conditions and situations that may occur. Common sense, caution and care must be exercised when operating or cleaning tools and equipment.

Always contact your dealer, distributor, service agent or manufacturer about problems or conditions you do not understand.



This is the safety alert symbol. It is used to alert you to potential personal injury hazards. Obey all safety messages that follow this symbol to avoid possible injury or death.



DANGER indicates an imminently hazardous situation, which, if not avoided, will result in death or serious injury.



WARNING indicates a potentially hazardous situation, which, if not avoided, could result in death or serious injury.



CAUTION indicates a potentially hazardous situation, which, if not avoided, may result in minor or moderate injury.



CAUTION used without the safety alert symbol indicates a potentially hazardous situation, which, if not avoided, may result in property damage.



NOTE provides additional information that is useful for proper use and maintenance for this tool. If a NOTE is indicated make sure it is fully understood.

## IMPORTANT SAFETY INSTRUCTIONS

### WORK AREA

#### **WARNING**

Keep your work area clean and well lit. Cluttered and dark work areas may cause accidents or injury.

Do not operate in explosive atmospheres, such as in the presence of flammable liquids, gases or dust. This could create sparks which may ignite the dust or fumes..

Keep bystanders, children and visitors away while operating. Distractions can cause you to lose control.

### TOOL USE & CARE

#### **CAUTION**

Do not force tool. Use the correct tool for your application. The correct tool will do the job better and safer at the rate for which it is designed.

Do not use the tool if the power switch does not turn it "ON" or "OFF". Any tool that cannot be controlled with the switch is dangerous and must be repaired.

Disconnect the power cord plug from the power source before making any adjustments, changing accessories or storing the tool. Such preventive safety measures reduce the risk of starting the tool accidentally.

Store idle tools out of reach of children and other untrained persons. Tools are dangerous in the hands of untrained users.

#### **WARNING**

Wash hands after handling the power cord. Touching the power cord could expose you to lead, which is known in the State of California to cause cancer, birth defects and other reproductive harm.

#### **WARNING**

All work areas should be clean and well lit. Accidents are more likely to occur in poorly lit and cluttered areas.

#### **WARNING**

Avoid dangerous oncoming traffic. Make sure to move the vehicle to a flat and level, oil/grease-free, ground surface as far away from the road or highway as possible before raising the vehicle with the Scissor Jack.

#### **WARNING**

Use common sense while operating this power tool.

Do not use this tool if you are:

- Feeling tired or are under the influence of alcohol or drugs.
- Wearing loose clothing or jewelry. Keep long hair pulled back and away from moving parts.
- Overreaching or have improper footing. Handling the tool in this way could cause serious injury.

When using this power tool always:

- Wear the proper safety equipment, such as safety goggles, dust masks, non-skid shoes, etc.

#### **WARNING**

Safety glasses and ear protection must be worn during operation.

**⚠ WARNING**

Maintain labels and nameplates on the tool. These carry important safety information.

## SERVICE

**NOTE**

Only qualified repair personnel must perform power tool service. Service or maintenance performed by unqualified personnel could result in a risk of injury.

## SAVE THESE INSTRUCTIONS FOR FUTURE REFERENCE.

This manual contains important information regarding safety, operation, maintenance and storage of this product. Before use, read carefully and understand all warnings, cautions, instructions and labels. Failure to do so could result in serious personal injury, property damage or even death.

## IMPORTANT SAFETY INSTRUCTIONS





**⚠ WARNING**

Before using this tool, you need to become familiar with the operation of the tool. If you are unsure about the operation of the tool, or have any questions about the proper use of the tool, call Customer Service at 1-888-287-6981.

## SPECIFIC SAFETY RULES AND/OR SYMBOLS

### SYMBOLS

The following symbols may be used on your tool. Be familiar with and learn the symbols to operate the tool safely.

Symbol	Name	Description
V	Volts	Voltage (Potential)
A	Amperes	Current
Hz	Hertz	Frequency (Cycles per Second)
W	Watt	Power
Kg	Kilograms	Weight
	Alternating Current	Type of Current
	Direct Current	Type of Current
	Alternating or Direct Current	Type of Current
	Earthing Terminal	Grounding Terminal
	Class II Construction	Denotes Double Insulation
min	Minutes	Time
s	Seconds	Time
$\phi$	Diameter	Size of Drill Bits, Grinding Wheel Bits, etc.
$n_0$	No Load Speed	No-load Rotational Speed
.../min	Revolutions per Minute	Revolutions, Surface Speed, Strokes, etc per Minute
1,2,3...	Ring Selector Settings	Speed, Torque or Position Settings

## FUNCTIONAL DESCRIPTION

### PACKAGE CONTENTS

- Electric Jack 1 Ton (2,000 lbs) Max
- Push Button Controller with 12 Ft Cord

# COMPONENTS LIST

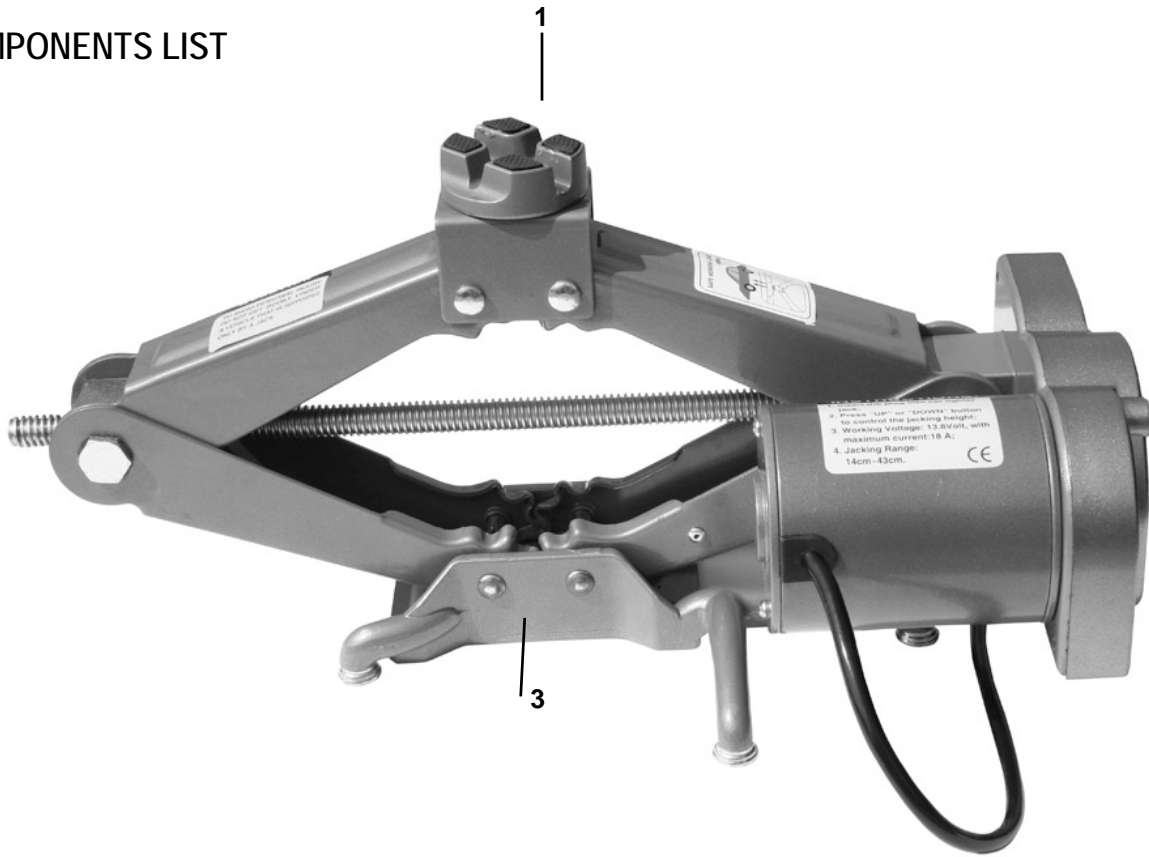

Part #	Description
1	Saddle
2	Cigarette Lighter Power Cable
3	Base
4	Push Button Remote Controller

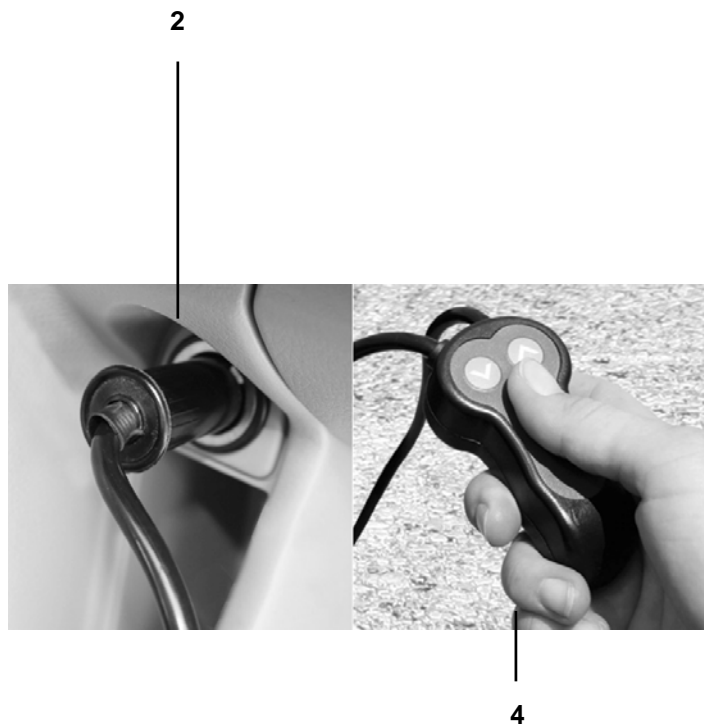

## OPERATION

### **⚠ WARNING**

Do not move the car while the electric jack is supporting the car. Keep your body away from the car or truck while the car jack is lifting the car. Do not put your body under the car.

### **⚠ WARNING**

Do not park the car on a slope. Do not overload the electric jack.

### **⚠ WARNING**

Use the Electric Jack only on vehicles whose frames have seams capable of aligning with the slotted saddle on the jack.

Park the car on smooth and solid ground and confirm that the emergency brake is set. Do not park on a slope.

Start the engine and insert the plug of the electric jack into the car lighter jack or power source.

Place the electric jack on smooth and solid ground. The saddle of the electric jack should be placed under the car, allowing for a secure metal surface to lift. **Block the tires opposite the tire being lifted.**

Do not allow anyone in the vehicle while using the Scissor Jack. Always keep hands, fingers, and feet away from the moving parts of the Scissor Jack when applying or releasing a load.

Press UP on the remote controller until the car is raised to the appropriate height.

Press DOWN on the remote controller to lower the car. Remove the power cord from the cigarette lighter or power source when finished.

**Important: Use the Electric Jack only on vehicles whose frames have seams capable of aligning with the slotted saddle on the jack.**

This Scissor Jack is designed to lift one wheel at a time for the purpose of emergency tire replacement. Once lifted, make sure to support the load immediately with appropriate vehicle support stands (not included).

## MAINTENANCE

### **CAUTION**

Some chemicals can damage the product. Do not use harsh chemicals such as gasoline, carbon tetrachloride, paint thinner, etc.

### **CAUTION**

A qualified repair technician must perform any tool service or repair. Service or maintenance performed by unqualified personnel could result in injury. Use only identical replacement parts. Use of unauthorized parts or failure to follow maintenance instructions may create a risk of electric shock or injury.

To replace the Fuse: A melted wire strand within the Fuse indicates the Fuse has "blown" and must be replaced. To replace the (20 Amp) Fuse, unscrew the cap on the DC Plug and remove the blown Fuse. Then, insert a new Fuse in the DC Plug and replace the cap.

Store in a cool, dry place.

## ACCESSORIES

Use only accessories that are recommended by the manufacturer for your model. Accessories that may be suitable for one tool may become hazardous when used on another tool.

(EJ2120905)