

## Use and Care Guide Fog-Free Mirror

Item #1001-083-694, 1001-083-699, 1001-083-701, 1001-083-704  
1001-083-705, 1001-083-710, 1001-083-714, 1001-083-715  
1001-083-716, 1001-083-717, 1001-083-811, 1001-083-196  
1001-083-198, 1001-083-202, 1002-286-030, 1002-286-023  
1002-286-026, 1002-286-027, 1002-286-031, 1002-286-025,  
1002-286-028, 1002-286-029  
Model #81155, 81156, 81157, 81158, 81159, 81161, 81162, 81163,  
81164, 81165, 81166, 81167, 81168, 81169, 45377, 45378,  
45379, 45380, 45381, 45382, 45383, 45384

HOME  
DECORATORS  
COLLECTION

### TOOLS REQUIRED

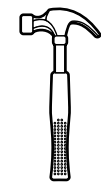

Hammer



Level

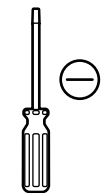

Flathead screwdriver

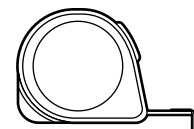

Tape measure



2 Wall anchors



Stud finder

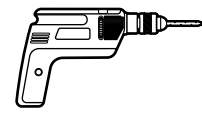

Drill

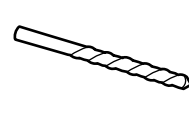

Drill bits (see Note)

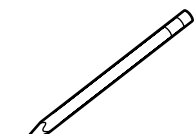

Pencil

### HARDWARE REQUIRED (Not Included)



2 Wall anchors



2 flathead wood screws  
#10 x 1-1/2 in. (38 mm)



**NOTE:** For gypsum wallboard and concrete walls, use 3/16 in. (5 mm) wood drill bit. For solid wood wall, use 1/16 in. (2 mm) wood drill bit.

## Installation

### 1 PREPARING THE INSTALLATION LOCATION



**WARNING:** Do not use wire between the hangers to hang the mirror. Using wire may cause the hangers to drip from the frame, causing injury.

Measure the distance between the centers of the hangers on the back of the mirror. Use a level to mark these two points on the wall.

Drill the holes:

- Gypsum wallboard or concrete walls: Drill holes using a 3/16 in. wood drill bit. With a hammer, gently tap each anchor (not included) into the holes until flush with the wall surface.
- Solid wood walls: Drill holes using a 1/16 in. wood drill bit. Anchors are not necessary.

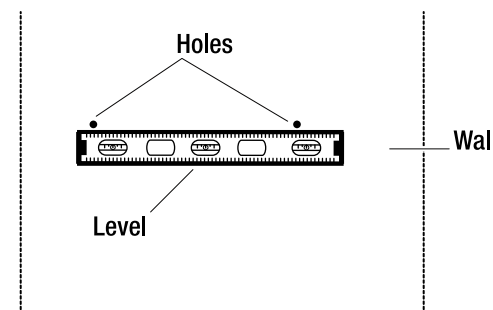

### 2 HANGING THE MIRROR

Install a screw (not included) in each anchor (if installing in wallboard or concrete), until the head of each screw is approximately 1/4 in. – 1/2 in. away from the wall.

Pull the screws firmly outward and downward to ensure that they are securely installed into the wall. The screws and anchors must remain securely in place for a safe installation. If loose, make new holes and install new anchors a couple of inches above or below the original anchors.

Hang the mirror on the screws using the hangers on the back of the mirror.

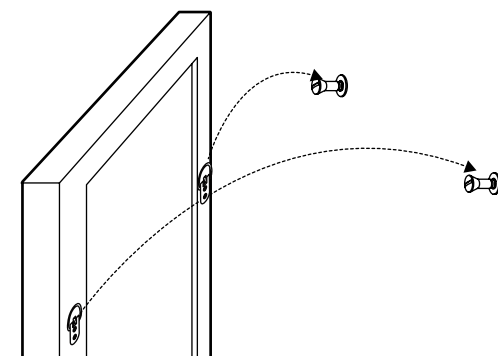

## Care and Cleaning

Use of a glass cleaner such as Windex®, Zep Commercial® Streak-Free Cleaner, or HDX™ Glass Cleaner. Follow application directions on the spray bottle. Use a soft paper towel or lint free cloth (preferred) and remove the cleaning solution in a gentle circular motion. If the mirror surface feels “tacky” while cleaning, simply apply more cleaner.

Never clean the mirror with a dry paper towel or lint free cloth without cleaning solution.

Do not use cleaners which include fragrances, oils, acids, alcohols, bleach, or abrasive particles.

Do not clean with a scouring pad, rough cloth, abrasive paper towel or window scraper.

HOME  
DECORATORS  
COLLECTION

HOMEDEPOT.COM/HOMEDECORATORS  
Please contact 1-800-986-3460 for further assistance.

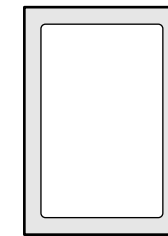

## Guía de uso y cuidado Espejo libre de niebla

Item #1001-083-694, 1001-083-699, 1001-083-701, 1001-083-704  
1001-083-705, 1001-083-710, 1001-083-714, 1001-083-715  
1001-083-716, 1001-083-717, 1001-083-811, 1001-083-196  
1001-083-198, 1001-083-202, 1002-286-030, 1002-286-023  
1002-286-026, 1002-286-027, 1002-286-031, 1002-286-025,  
1002-286-028, 1002-286-029  
Model #81155, 81156, 81157, 81158, 81159, 81161, 81162, 81163,  
81164, 81165, 81166, 81167, 81168, 81169, 45377, 45378,  
45379, 45380, 45381, 45382, 45383, 45384

HOME  
DECORATORS  
COLLECTION

### HERRAMIENTAS REQUERIDAS

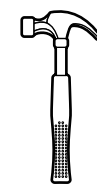

Martillo



Nivel

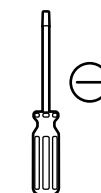

Destornillador de punta plana

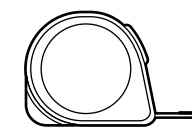

Cinta métrica



2 anclas de pared



Localizador de montantes

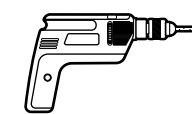

Taladro

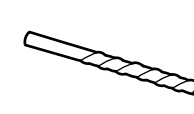

Brocas (ver nota)

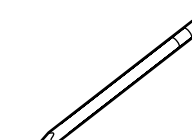

Lápiz



**NOTA:** Para tableros de yeso y paredes de concreto, use broca para madera de 3/16 pulg. (5 mm). Para pared de madera sólida, use broca para madera de 1/16 pulg. (2 mm).

### HERRAJE REQUERIDO (no incluida)



2 anclas de pared

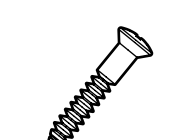

2 tornillos de madera cabeza plana #10 x 1-1/2 pulg. (38 mm)

## Instalación

### 1 PREPARACIÓN DE LA UBICACIÓN DE INSTALACIÓN



**ADVERTENCIA:** No use alambre entre los colgaderos para colgar el espejo. El uso de alambre puede hacer que los colgaderos goteen del marco, ocasionando lesiones.

Mida la distancia entre los centros de los colgaderos en la parte de atrás del espejo. Use un nivel para marcar estos puntos sobre la pared.

Perfore los agujeros:

- Tablero de yeso o paredes de concreto: Perfore los agujeros usando una broca para madera de 3/16 pulg. Con un martillo, golpee suavemente cada ancla (no incluidas) en los agujeros hasta que estén alineadas con la superficie de la pared.
- Paredes de madera sólida: Perfore los agujeros usando una broca para madera de 1/16 pulg. No son necesarias las anclas.

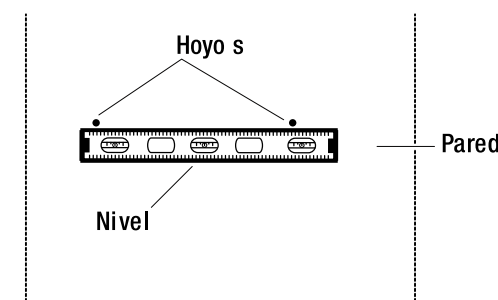

### 2 CÓMO COLGAR EL ESPEJO

Instale un tornillo (no incluido) en cada ancla (si está instalando en tablero o concreto), hasta que la cabeza de cada tornillo esté a aproximadamente 1/4 pulg. – 1/2 pulg. de la pared.

Tire de los tornillos con firmeza hacia afuera y hacia adentro para asegurarse de que estén instalados con seguridad en la pared. Los tornillos y las anclas deben permanecer seguros en su lugar para una instalación segura. Si se aflojan, haga nuevos agujeros e instale nuevas anclas un par de pulgadas arriba o debajo de las anclas originales.

Cuelgue el espejo en los tornillos usando los colgaderos en la parte de atrás del espejo.

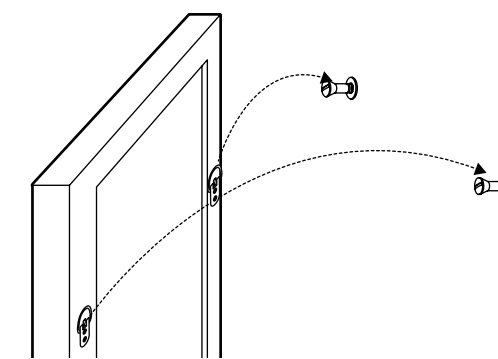

## Cuidado y limpieza

Use un limpiador de vidrio que no deja manchas como Windex®, Zep Commercial® Streak-Free Cleaner o HDX™ Glass Cleaner. Siga las instrucciones de aplicación de la botella pulverizadora. Use una toalla de papel suave o libre de pelusa (preferido) y retire la solución de limpieza con un movimiento suave y circular. Si la superficie del espejo se siente “pegajosa” mientras limpia, simplemente aplique más limpiador.

Nunca limpie el espejo con una toalla de papel seco o paño libre de pelusa sin solución limpiadora.

No use limpiadores que incluyan fragancias, aceites, ácidos, alcohólos, blanqueador o partículas abrasivas.

No limpie con una almohadilla pulidora, paño áspero, toalla de papel abrasivo o raspador de ventana.

HOME  
DECORATORS  
COLLECTION

HOMEDEPOT.COM/HOMEDECORATORS  
Póngase en contacto con el 1-800-986-3460 para recibir más ayuda.