



Scan this with your smartphone

Scan the QR code* or visit
www.samsung.com/spsn
to view our helpful
How-to Videos and Live Shows

*Requires reader to be installed on your
smartphone

Please be advised that the Samsung warranty does NOT cover service calls to explain product operation, correct improper installation, or perform normal cleaning or maintenance.

QUESTIONS OR COMMENTS?

COUNTRY	CALL	OR VISIT US ONLINE AT
U.S.A Consumer Electronics	1-800-SAMSUNG (726-7864)	www.samsung.com/us/support
CANADA	1-800-SAMSUNG (726-7864)	www.samsung.com/ca/support (English) www.samsung.com/ca_fr/support (French)

Microwave Oven

User manual

MC17J8000CS



SAMSUNG

Contents

Important safety instructions	4
Setting up your new microwave oven	15
Checking the parts	15
Setting up your microwave oven	16
Installing the metal shelf	16
Checking the control panel	17
Setting the time	18
Using my setting feature	18
Using your microwave oven	20
Using the stop/clear button	20
Using the child lock	20
Using the kitchen timer	20
Using the microwave +30 sec. feature	21
Using the more/less feature	21
Using the eco mode	21
Using the steam clean feature	22
Turntable on/off feature	23
Turning on the light	23
Turning on the vent	23
Using the warm hold feature	24
Using the defrost button	24
Accessory usage - Use accessories in the combinations shown below	26
Using the slim fry button	26
Using the fit choice button	28
Using the popcorn button	34
Using the speed cook button	35
Using the auto cook button	42
Using the express menu feature	49
Using the microwave setting cooking times & power levels	51
Power levels	51
One-stage cooking	51
Multi-stage cooking (maximum of 2 stages)	52
Steam cooking guide	52
Brown	54
Convection bake/roast	54
Speed bake/roast	56
Cookware for cooking with speed bake/roast	57

Food suitable for speed bake/roast	57
Speed bake/roast cooking guide	57
Cookware guide	59
<hr/>	
Recommended cooking utensils	59
Limited use items	59
Not recommended	59
Testing utensils	60
Cooking guide	61
<hr/>	
Cooking techniques	61
Recommended cooking utensils	62
Guide for cooking eggs in your microwave	62
Guide for cooking vegetables in your microwave	62
Cleaning and maintaining your microwave oven	63
<hr/>	
Cleaning the exterior	63
Cleaning under your microwave oven	63
Cleaning the control panel	63
Cleaning the door and door seals	63
Cleaning the interior	63
Cleaning the turntable and roller rings	63
Storing and repairing your microwave oven	64
Replacing the cooktop/night light	64
Replacing the oven light	65
Cleaning the grease filter	66
Replacing the charcoal filter	67
Troubleshooting	68
<hr/>	
Check points	68
Information codes	73
Appendix	74
<hr/>	
Specifications	74
Warranty	75
<hr/>	
Samsung over-the-range (otr) microwave oven	75

Important safety instructions

Congratulations on your new Samsung microwave oven. This manual contains important information on the installation, use and care of your appliance. Please take time to read this manual to take full advantage of your microwave oven's many benefits and features.

WHAT YOU NEED TO KNOW ABOUT SAFETY INSTRUCTIONS

Warnings and Important Safety Instructions in this manual do not cover all possible conditions and situations that may occur. It is your responsibility to use common sense, caution, and care when installing, maintaining, and operating your microwave oven.

PRECAUTIONS TO AVOID POSSIBLE EXPOSURE TO EXCESSIVE MICROWAVE ENERGY

- A.** Do not attempt to operate this oven with the door open since open-door operation can result in harmful exposure to microwave energy. It is important not to defeat or tamper with the safety interlocks.
- B.** Do not place any object between the oven front face and the door or allow soil or cleaner residue to accumulate on the sealing surface.
- C.** Do not operate the oven if it is damaged. It is particularly important that the oven door close properly and that there is no damage to the:
 - 1.** Door (bent),
 - 2.** Hinges and latches, (broken or loosened),
 - 3.** Door seals and sealing surface.
- D.** Only properly qualified service personnel should adjust or repair the oven. Do not attempt to adjust or repair the oven yourself.

SAVE THESE INSTRUCTIONS

IMPORTANT SAFETY SYMBOLS AND PRECAUTIONS

What the icons and signs in this user manual mean:

WARNING









Hazards or unsafe practices that may result in **severe personal injury or death**.

CAUTION

Hazards or unsafe practices that may result in **minor personal injury or property damage**.

CAUTION

To reduce the risk of fire, explosion, electric shock, or personal injury when using your microwave oven, follow these basic safety precautions.

- | | | | |
|-------------------------------------------------------------------------------------|-------------------------------|-------------------------------------------------------------------------------------|--------------------------------------------------------------|
|  | Do NOT attempt. |  | Unplug the power plug from the wall socket. |
|  | Do NOT disassemble. |  | Make sure the machine is grounded to prevent electric shock. |
|  | Do NOT touch. |  | Call the service center for help. |
|  | Follow directions explicitly. |  | Note |

These warning signs are here to prevent injury to you and others. Please follow them explicitly. After reading this section, keep it in a safe place for future reference.

STATE OF CALIFORNIA PROPOSITION 65 WARNING (US ONLY)

WARNING : This product contains chemicals known to the State of California to cause cancer and birth defects or other reproductive harm.

SAVE THESE INSTRUCTIONS

Important safety instructions

When using any electrical appliance, basic safety precautions should be followed, including the following:

WARNING

 To reduce risk of burns, electric shock, fire, personal injury or exposure to excessive microwave energy:

1. Read all safety instructions before using the appliance.
2. Read and follow the specific “Precautions to avoid possible exposure to excessive microwave energy” on page 4.
3. This appliance must be grounded. Connect only to properly grounded outlets. See Important “Grounding instructions” on page 8 of this manual.
4. Install or locate this appliance only in accordance with the provided installation instructions.
5. Some products such as whole eggs and sealed containers (for example, closed glass jars) can explode if heated rapidly. Never heat them in a microwave oven.
6. Use this appliance only for its intended use as described in the manual. Do not put corrosive chemicals or vapors in or on this appliance. This type of oven is specifically designed to heat, cook, or dry food. It is not designed for industrial or laboratory use.
7. As with any appliance, close supervision is necessary when it is used by children. Keep children away from the door when opening or closing it as they may bump themselves on the door or catch their fingers in the door.
8. Do not operate this appliance if it has a damaged cord or plug, if it is not working properly, or if it has been damaged or dropped.
9. This appliance should be repaired or serviced only by qualified service personnel. Contact the nearest authorized service facility for examination, repair, or adjustment.
10. Do not cover or block any openings on the appliance.
11. Do not tamper with or make any adjustments or repairs to the door.
12. Do not store this appliance outdoors. Do not use this product near water, for example, near a kitchen sink, in a wet basement, near a swimming pool, or similar locations.
13. Do not immerse the cord or plug in water.
14. Keep the cord away from heated surfaces. (including the back of the oven).
15. Do not let the cord hang over edge of table or counter.

SAVE THESE INSTRUCTIONS

-
- 16.** When cleaning surfaces of the door and oven that come together when the door closes, use only mild, nonabrasive soaps, or detergents applied with a sponge or soft cloth. Unplug the plug before cleaning.
 - 17.** To reduce the risk of fire in the oven cavity:
 - a.** Do not overcook food. Carefully attend appliance when paper, plastic, or other combustible materials are placed inside the oven to facilitate cooking.
 - b.** Remove wire twist-ties from paper or plastic bags before placing the bags in the oven.
 - c.** If materials inside the oven ignite, keep the oven door closed, turn the oven off, and disconnect the power cord, or shut off the power at the fuse or circuit breaker panel. If the door is opened, the fire may spread.
 - d.** Do not use the cavity for storage purposes. Do not leave paper products, cooking utensils, or food in the cavity when not in use.
 - 18.** Liquids, such as water, milk, coffee, or tea can be overheated beyond the boiling point without appearing to be boiling. Visible bubbling or boiling when the container is removed from the microwave oven is not always present. **THIS COULD RESULT IN VERY HOT LIQUIDS SUDDENLY BOILING OVER WHEN THE CONTAINER IS DISTURBED OR A SPOON OR OTHER UTENSIL IS INSERTED INTO THE LIQUID.** To reduce the risk of injury:
 - a.** Do not overheat liquid.
 - b.** Stir liquid both before and halfway through heating it.
 - c.** Do not use straight-sided containers with narrow necks.
 - d.** After heating, allow the container to stand in the microwave oven for a short time before removing the container.
 - e.** Use extreme care when inserting a spoon or other utensil into the container.
 - 19.** Oversized foods or oversized metal utensils should not be inserted in microwave / toaster oven as they may create a fire or electric shock.
 - 20.** Do not clean with metal scouring pads. They can burn off the pad and touch electrical parts involving a risk of electric shock.
 - 21.** Do not use paper products when appliance is operated in the toaster mode.
 - 22.** Do not store any materials, other than manufacturer's recommended accessories, in this oven when not in use.
 - 23.** Do not cover racks or any other part of the oven with metal foil. This will cause overheating of the oven.

SAVE THESE INSTRUCTIONS

Important safety instructions

CAUTION

1. Clean Ventilating Hoods Frequently - Grease should not be allowed to accumulate on the hood of the filter.
2. When flaming foods under the hood, turn the fan on.
3. Use care when cleaning the vent-hood filter. Corrosive cleaning agents, such as lye-based oven cleaner, may damage the filter.

GROUNDING INSTRUCTIONS

This appliance must be grounded. In the event of an electrical short circuit, grounding reduces the risk of electric shock by providing an escape wire for the electrical current. This appliance is equipped with a cord that includes a grounding wire and a grounding plug. The plug must be plugged into an outlet that is properly installed and grounded.

WARNING

Improper use of the grounding plug can result in a risk of electric shock.

- Plug into a grounded, 3 pronged outlet. Do not remove the third (grounding) prong. Do not use an adaptor or otherwise thwart the safety function of the grounding plug.
- Consult a qualified electrician or service person if you do not understand the grounding instructions or if you are not sure if the appliance is properly grounded.
- We do not recommend using an extension cord with this appliance. If the power-supply cord is too short, have a qualified electrician or serviceman install an outlet near the appliance. However, if it is necessary to use an extension cord, read and follow the "Use of Extension Cords" section on the next page.

SAVE THESE INSTRUCTIONS

USE OF EXTENSION CORDS

A short power-supply cord is provided to reduce the risk of your becoming entangled in or tripping over a longer cord. Longer cord sets or extension cords are available and you can use them if you exercise care. If you use a long cord or extension cord:

1. The marked electrical rating of the cord set or extension cord should be at least as great as the electrical rating of the appliance.
2. The extension cord must be a grounding-type 3-wire cord and it must be plugged into a 3-slot outlet.
3. The longer cord should be arranged so that it will not drape over the counter top or tabletop where it can be pulled on by children or tripped over accidentally. If you use an extension cord, the interior light may flicker and the speed of the blower may vary when the microwave oven is on. Cooking times may be longer too.

CRITICAL INSTALLATION WARNINGS



This appliance must be installed by a qualified technician or service company.

- Failing to have a qualified technician install the oven may result in electric shock, fire, an explosion, problems with the product, or injury.

Unpack the oven, remove all packaging material and examine the oven for any damage such as dents on the interior or exterior of the oven, broken door latches, cracks in the door, or a door that is not lined up correctly. If there is any damage, do not operate the oven and notify your dealer immediately.

Make sure to install your oven in a location with adequate space.

Remove all foreign substances such as dust or water from the power plug terminals and contact points using a dry cloth on a regular basis.

- Unplug the power plug and clean it with a dry cloth.
- Failing to do so may result in electric shock or fire.

Plug the power cord into a properly grounded 3 pronged outlet. Your oven should be the only appliance connected to this circuit.

- Sharing a wall socket with other appliances, using a power strip, or extending the power cord may result in electric shock or fire.
- Do not use an electric transformer. It may result in electric shock or fire.
- Ensure that the voltage, frequency and current provided match the product's specifications. Failing to do so may result in electric shock or fire.

Keep all packaging materials out of the reach of children. Children may use them for play.

SAVE THESE INSTRUCTIONS

Important safety instructions



This appliance must be properly grounded. Read and follow the specific “Grounding instructions” found in the beginning of this section. Do not ground the appliance to a gas pipe, plastic water pipe, or telephone line.

- This may result in electric shock, fire, an explosion, or problems with the product.
- Never plug the power cord into a socket that is not grounded correctly and make sure that it is grounded in accordance with local and national codes.

Do not cut or remove the third (ground) prong from the power cord under any circumstances.

Connect the oven to a 20A circuit. If you connect the oven to a 15A circuit, make sure that the circuit breaker is operable.



Do not install this appliance in a humid, oily, or dusty location, or in a location exposed to direct sunlight or water (rain drops).

- This may result in electric shock or fire.

Plug the power plug into the wall socket firmly. Do not use a damaged power plug, damaged power cord, or loose wall socket.

- This may result in electric shock or fire.

Do not mount over a sink.

Do not pull or excessively bend the power cord.

Do not twist or tie the power cord.

Do not hook the power cord over a metal object, place a heavy object on the power cord, insert the power cord between objects, or push the power cord into the space behind the appliance.

- This may result in electric shock or fire.

Do not pull the power cord when you unplug the oven.



- Unplug the oven by pulling the plug only.
- Failing to do so may result in electric shock or fire.



When the power plug or power cord is damaged, contact your nearest service center for a replacement or repair.

SAVE THESE INSTRUCTIONS

INSTALLATION CAUTIONS

-  Position the oven so that the plug is easily accessible.
 - Failing to do so may result in electric shock or fire due to electric leakage.
-  Unplug the oven when it is not being used for long periods of time or during a thunder/lightning storm.
 - Failing to do so may result in electric shock or fire.

CRITICAL USAGE WARNINGS

-  If the microwave appliance is flooded, please contact your nearest service center. Failing to do so may result in electric shock or fire.

Read and follow the specific “Precautions to Avoid Possible Exposure to Excessive Microwave Energy”, found in the beginning of this Safety Information Section.

If the microwave generates a strange noise, a burning smell or smoke, unplug it immediately and contact your nearest service center.

 - Failing to do so may result in electric shock or fire.

In the event of a gas leak (propane gas, LP gas, etc.), ventilate the room immediately. Do not touch the microwave, power cord, or plug.

 - Do not use a ventilating fan.
 - A spark may result in an explosion or fire.

Take care that the door or any of the other parts do not come into contact with your body while cooking or just after cooking.

 - Failing to do so may result in burns.

In the event of a grease fire on the surface units below the oven, smother the flaming pan on the surface unit by covering the pan completely with a lid, a cookie sheet, or a flat tray.

Never leave surface units beneath your oven unattended at high heat settings. Boil overs cause smoking and greasy spillovers that may ignite and spread if the vent fan is operating. To minimize automatic fan operation, use adequate sized cookware and use high heat on surface units only when necessary.

If materials inside the oven should ignite, keep the oven door closed, turn the oven off and disconnect the power cord, or shut off power at the fuse or circuit breaker panel. If the door is opened, the fire may spread.

 - Always observe safety precautions when using your oven. Never try to repair the oven on your own. There is dangerous voltage inside. If the oven needs to be repaired, contact an authorized service center near you.

SAVE THESE INSTRUCTIONS

Important safety instructions

-  Do not attempt to repair, disassemble, or modify the appliance yourself.
 - Because a high voltage current enters the product chassis during operation, opening the chassis can result in electric shock or fire.
 - You may be exposed to electromagnetic waves.
 - When the oven requires repair, contact your nearest service center.

-  If any foreign substance such as water enters the microwave, unplug it, and then contact your nearest service center.

- Failing to do so may result in electric shock or fire.

-  Do not touch the power plug with wet hands.

- This may result in electric shock.

Do not turn the appliance off by unplugging the power plug while the appliance is in operation.

- Plugging the power plug into the wall socket again may cause a spark and result in electric shock or fire.

Keep all packaging materials well out of the reach of children. Packaging materials can be dangerous to children.

- If a child places a bag over its head, the child can suffocate.

Do not let children or any person with reduced physical, sensory or mental capabilities use this appliance unsupervised. Make sure that the appliance is out of the reach of children.

- Failing to do so may result in electric shock, burns, or injury.

Do not touch the inside of the appliance immediately after cooking. The inside of the appliance will be hot.

- The heat on the inside of the oven can cause burns.

Do not put aluminum foil (except as specifically directed in this manual), metal objects (such as containers, forks, etc.), or containers with golden or silver rims into the microwave.

- These objects can cause sparks or a fire.

Do not use or place flammable sprays or objects near the oven.

- Heat from the microwave can cause flammable sprays to explode or burn.

- Failing to do so may result in electric shock or injury.

Do not tamper with or make any adjustments or repairs to the door. Under no circumstances should you remove the outer cabinet.

Do not store or use the oven outdoors.

SAVE THESE INSTRUCTIONS

USAGE CAUTIONS

- ★ If the surface of the microwave is cracked, turn it off.
 - Failing to do so may result in electric shock.

Dishes and containers can become hot. Handle with care.

Hot foods and steam can cause burns. Carefully remove container coverings, directing steam away from your hands and face.

Remove lids from baby food before heating. After heating baby food, stir well to distribute the heat evenly. Always test the temperature by tasting before feeding the baby. The glass jar or surface of the food may appear to be cooler than the food in the interior, which can be so hot that it will burn the infant's mouth.

Make sure all cookware used in the oven is suitable for microwaving.

Use microwavable cookware in strict compliance with such manufacturer's recommendations.
- ☐ Do not stand on top of the microwave or place objects (such as laundry, oven covers, lighted candles, lighted cigarettes, dishes, chemicals, metal objects, etc.) on the appliance.
 - Items, such as a cloth, may get caught in the door.
 - This may result in electric shock, fire, problems with the product, or injury.

Do not operate the appliance with wet hands.

 - This may result in electric shock.

Do not spray volatile material such as insecticide onto the surface of the appliance.

 - As well as being harmful to humans, it may also result in electric shock, fire or problems with the product.

Do not place the appliance over a fragile object such as a sink or glass object.

 - This may result in damage to the sink or glass object.

Do not put your face or body close to the appliance while cooking or when opening the door just after cooking.

 - Take care that children do not come too close to the appliance.
 - Failing to do so may result in children burning themselves.

Do not place food or heavy objects over the door when opening the door.

 - The food or object may fall and this may result in burns or injury.

Do not abruptly cool the door, the inside of the appliance, or the dish by pouring water over it during or just after cooking.

 - This may result in damage to the appliance. The steam or water spray may result in burns or injury.

Do not cook without the glass tray in place on the oven floor. Food will not cook properly without the tray.

SAVE THESE INSTRUCTIONS

Important safety instructions

- ☐ Do not defrost frozen beverages in narrow-necked bottles. The containers can break.
- Do not scratch the glass of the oven door with a sharp object.
 - This may result in the glass being damaged or broken.
- Do not store anything directly on top of the appliance when it is in operation.
- Do not use sealed containers. Remove seals and lids before use. Sealed containers can explode due to buildup of pressure even after the oven has been turned off.

! CRITICAL CLEANING INSTRUCTIONS

Do not clean the appliance by spraying water directly onto it.

Do not use benzene, thinner, or alcohol to clean the appliance.

- This may result in discoloration, deformation, damage, electric shock, or fire.

Before cleaning or performing maintenance, unplug the appliance from the wall socket and remove food waste from the door and cooking compartment.

- Failing to do so may result in electric shock or fire.

Take care not to hurt yourself when cleaning the appliance.
(external/internal)

- You may hurt yourself on the sharp edges of the appliance.

Do not clean the appliance with a steam cleaner.

- This may result in corrosion.

Keep the inside of the oven clean. Food particles or spattered oils stuck to the oven walls or floor can cause paint damage and reduce the efficiency of the oven.

SAVE THESE INSTRUCTIONS

Setting up your new microwave oven

Be sure to follow these instructions closely so that your new microwave oven works properly.

Checking the parts

Carefully unpack your microwave oven, and make sure you've received all the parts shown below. If your microwave oven was damaged during shipping, or if you do not have all the parts, contact the Samsung Call Center. (Refer to the "WARRANTY AND SERVICE INFORMATION" on page 75.)

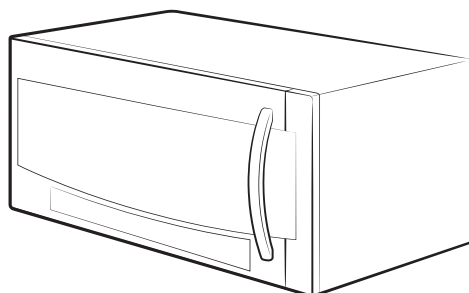

Microwave oven



* Ceramic Enamel Tray

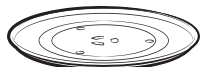

* Glass Tray



* Roller Guide Ring

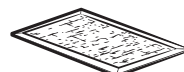

* Grease Filters (2 ea)

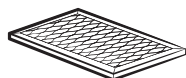

* Charcoal filter

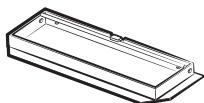

* Exhaust adaptor



* Hardware kit (Screws & Brackets)



Manuals (User & Installation)

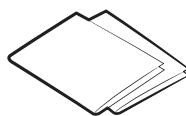

Templates (Top & Wall)



Cooking Guide Manual



* Low Rack

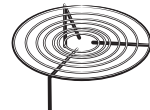

* High Rack

NOTE

If you need an accessory marked with an * (asterisk), please contact the Samsung Call Center using the phone number listed on the last page of this manual or visit our on-line parts web site at www.samsungparts.com.

Setting up your new microwave oven

Setting up your microwave oven

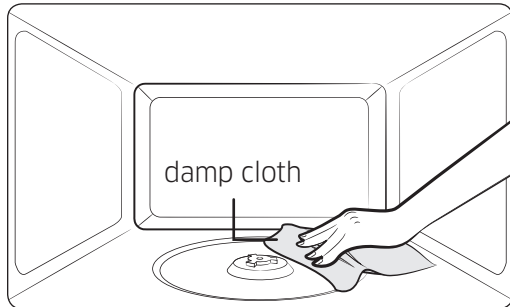

1. Open the door by pulling the handle on the right side of the door.
2. Wipe the inside of the oven with a damp cloth.

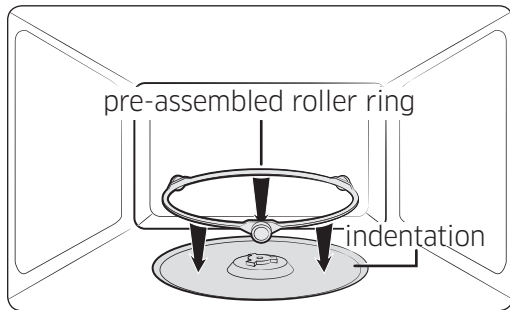

3. Install the pre-assembled ring into the indentation at the center of the microwave oven.

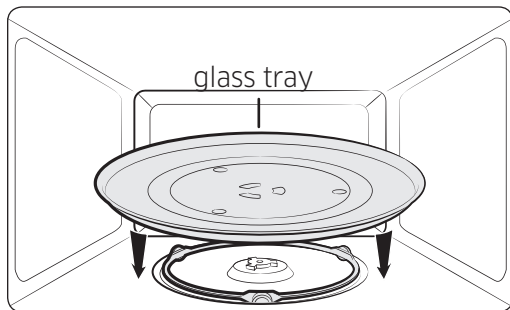

4. Place the glass tray securely in the center of the pre-assembled roller ring.

Installing the metal shelf

When you need to use the Metal Shelf, place it on the plastic hooks inside your oven and make sure it is positioned properly to avoid electrical arcing that can damage your oven.

⚠ CAUTION

Make sure the shelf is positioned properly inside the microwave to prevent damage to the oven from arcing.

Checking the control panel

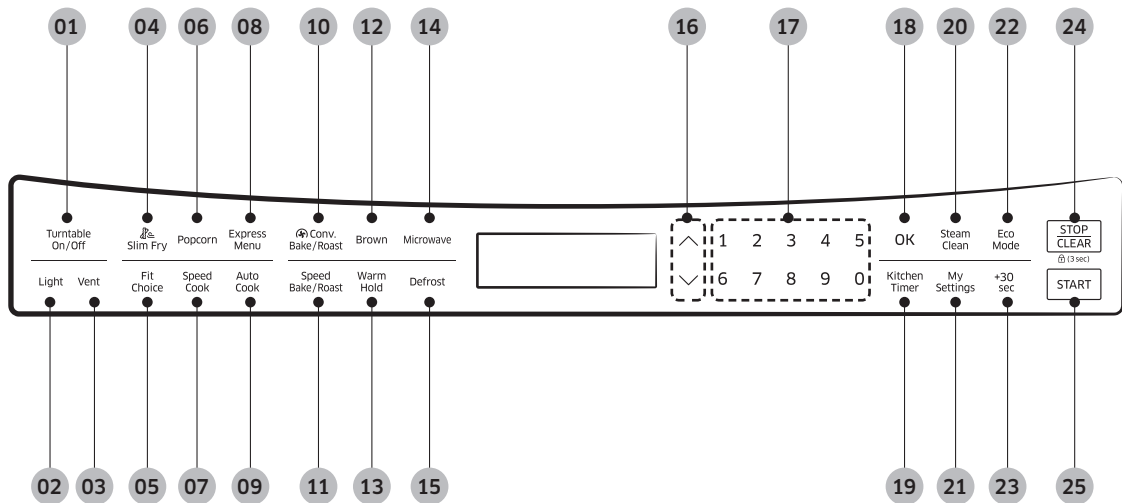

- 01** Turntable On/Off Button
- 02** Light Button (Hi/Low/Off)
- 03** Vent Button (3 Speed & On/Off)
- 04** Slim Fry Button
- 05** Fit Choice Button
- 06** Popcorn Button
- 07** Speed Cook Button
- 08** Express Menu Button
- 09** Auto Cook Button
- 10** Convection Bake/Roast Button
- 11** Speed Bake/Roast Button
- 12** Brown Button
- 13** Warm Hold Button

- 14** Microwave Button
- 15** Defrost Button
- 16** Up&Down Buttons
- 17** Numeric Buttons
- 18** OK Button
- 19** Kitchen Timer Button
- 20** Steam Clean Button
- 21** My Settings Button
- 22** Eco Mode Button
- 23** +30sec Button
- 24** Stop/Clear Button
- 25** Start Button

Setting up your new microwave oven

Setting the time

Your microwave oven is equipped with a built-in clock. Set the clock when first installing your microwave oven and after a power failure. The time is displayed whenever the microwave oven is not being used.

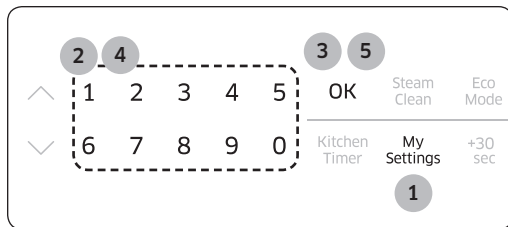

1. Press the **My Settings** button.
2. Press the **9** button.
3. Press the **OK** button.
4. Use the **numeric** buttons to enter the current time. You need to press at least three numbers to set the clock. For example, if the current time is 5:00, press 5, 0, 0. The display will show 5 : 00.
5. Press the **OK** button.

Using my setting feature

You can customize your new microwave oven to suit your preferences.

To customize:

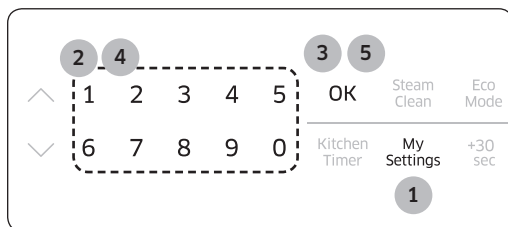

1. Press the **My Settings** button.
2. Press one of the **numeric** buttons to select a function you want to customize.
3. Press the **OK** button.
4. Press one of the **numeric** buttons to select a function you want to customize.
5. Press the **OK** button.

The functions, options, and corresponding numeric buttons are listed in the table below.

No.	Function	Description	Options
1	Display Weight	Weight options are pounds and kilograms.	1 Lbs. 2 Kg.
2	12 HR/24 HR	The clock can display in either the 12 HR or 24 HR time mode.	1 12 HR 2 24 HR
3	Sound	Sound can be turned On and Off.	1 Sound ON 2 Sound OFF
4	Remind End Signal	The Remind End Signal can be turned On and Off.	1 ON 2 OFF
5	Daylight Savings Time Adjustment	The time can be advanced one hour for DST without resetting the clock.	1 ON (to advance one hour) 2 OFF (to go back one hour)
6	Demo Mode	The Demo Mode can be turned On and Off.	1 ON 2 OFF
7	Filter Remind	The Filter Remind function can be turned On and Off.	1 ON 2 OFF
8	Word Scroll Speed	There are three speeds, Slow, Normal, and Fast. The default is Normal speed.	1 Slow speed 2 Normal speed 3 Fast speed
9	Clock	The clock can be adjusted.	Press the numeric buttons to enter the current time. (First 2 digits are for hours, last 2 digits are for minutes.)

NOTE

If you change your mind while adjusting a setting, press the **STOP/CLEAR** button to cancel, and then adjust the setting again.

NOTE

If there is a power interruption, you will need to reset these options.

NOTE

If the clock is set for standard time, the **Daylight Savings Time Adjustment** function allows you to change the time easily without needing to reset the clock. **Daylight Saving Time** begins for most of the United

States at 2 a.m. on the first Sunday of April and reverts to Standard time at 2 a.m. on the last Sunday of October.

Filter Reminder

If the **Filter Remind** function is **ON**, the microwave will remind you to clean or replace the grease filter every four months. When it is time to clean or replace the grease filter, the microwave displays the “Filter” message to remind you to clean or replace the grease filter. To remove the message, press the number 0 when the microwave is in standby mode. If you don’t want to receive this message, set the **Filter Remind** function off in **My settings**.

Using your microwave oven

Using the stop/clear button

The **STOP/CLEAR** button allows you to clear instructions you have entered.

It also allows you to pause the oven's cooking cycle, so that you can check the food.

- To pause the oven during cooking, press the **STOP/CLEAR** button once. To restart, press the **START** button.
- To stop cooking, erase instructions, and return the oven display to the time of day, press the **STOP/CLEAR** button twice.
- To clear instructions you have just entered, press the **STOP/CLEAR** button once, and then re-enter the instructions.
- To cancel a timer setting, press the **STOP/CLEAR** button once.

Using the child lock

The **Child Lock** function allows you to lock all buttons except **Eco Mode** so that the microwave oven cannot be operated by children accidentally. The oven can be locked at any time.

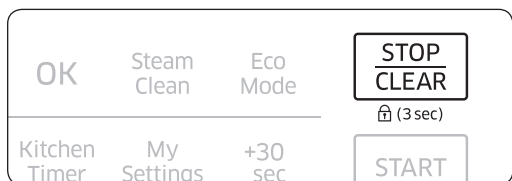

Activating / Deactivating

If you want to activate or deactivate the child lock function, press the **STOP/CLEAR** button for 3 seconds. The display will show 'CHILD LOCK ON' or 'CHILD LOCK OFF' when the oven is locked or unlocked, and then redisplay the time.

Using the kitchen timer

Your microwave has a built-in timer function - the Kitchen Timer. Use the Kitchen Timer for timing up to 99 minutes, 99 seconds.

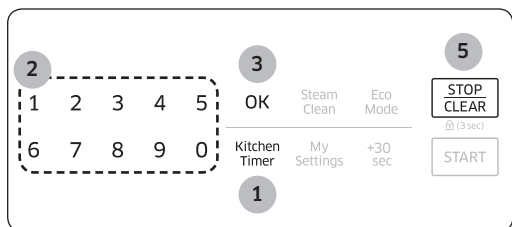

1. Press the **Kitchen Timer** button.
2. Use the **numeric** buttons to set the time you want the timer to run. (Max time 99 minutes, 99 seconds.)
3. Press the **OK** button.
4. The display counts down and beeps when the time has elapsed.
5. To cancel the timer setting : Press the **STOP/CLEAR** button once.

Using the microwave +30 sec. feature

This feature offers a convenient way to heat food in set time increments at the High power level (100 % power).

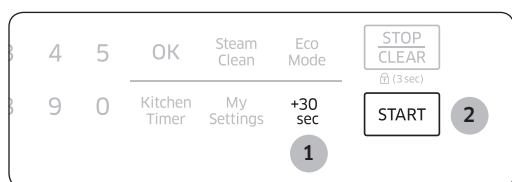

1. Press the **+ 30 sec** button for each additional 30 seconds you want the food to be cooked for. (For example, press the button twice to cook for one minute.)

2. Press the **START** button.

NOTE

When the oven is operating, if you press the **+ 30 sec** button, the cooking time will be increased by 30 seconds.

Using the more/less feature

The More or Less feature allows you to adjust the pre-set cooking time. It works with 1 and 2 stage cooking, MW, Bake, Roast, Brown, Speed Bake/Roast, and Warm Hold buttons.

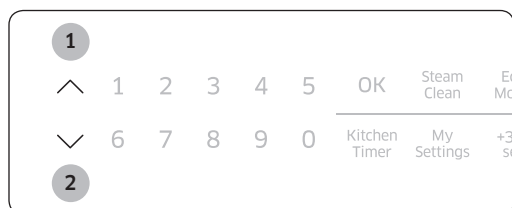

Use the **More or Less** feature only after cooking has begun.

1. To **ADD** more time to a cooking procedure, press the **More** button. Each time you press the **More** button, the cooking time will be increased by 10 seconds.

2. To **REDUCE** the time of a cooking procedure, press the **Less** button. Each time you press the **Less** button, the cooking time will be decreased by 10 seconds.

Using the eco mode

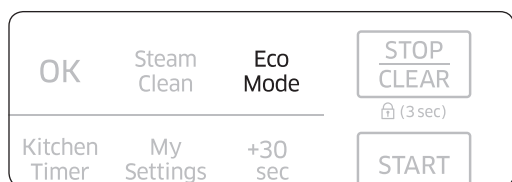

Eco Mode reduces standby power usage. When you press the **Eco Mode** button once, the display will go out and the microwave shifts to a mode which minimizes power usage. To cancel the Eco Mode, press the **Eco Mode** button once again, or press any other button.

Using your microwave oven

Using the steam clean feature

The steam provided by the steam clean system will soak the cavity surface. After using the steam clean function, you can easily clean the cavity of the oven.

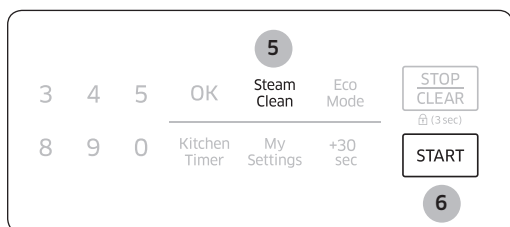

1. Open the door.
2. Carefully pour about 2fl.oz. of water into a wide plate.
3. Place the plate on the tray of the microwave oven.
4. Close the door.
5. Press the **Steam Clean** button.
6. Press the **START** button. Steam clean will operate for 6 minutes and 30 seconds. The length of time cannot be modified.
7. When the cleaning time is over, the oven will beep. Open the door.
8. Clean the cavity of the oven with a dry dishtowel. Remove the turntable and wipe under the rack with a piece of paper towel.

NOTE

Use this function only after the oven has completely cooled.

NOTE

Use normal tap water only. Do not use distilled water.

CAUTION

The water in the oven will be very hot due to the steam cleaning function. Wipe up carefully.

Turntable on/off feature

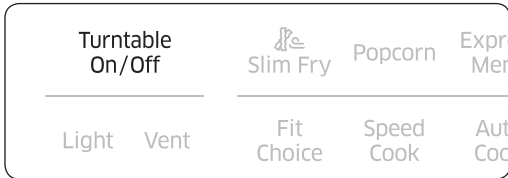

For best cooking results, leave the turntable on. However, for large dishes it can be turned off.

Press the **Turntable On/Off** button to turn the turntable on or off.

CAUTION

The turntable may become too hot to touch. Use pot holders to handle the turntable during and after cooking.

Turning on the light

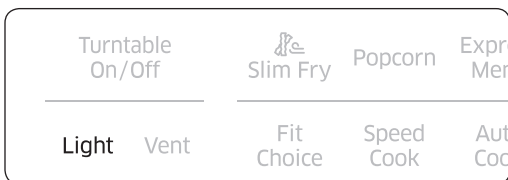

Press the **Light** button to turn the cooktop lamp on or off. Press the button once for high, twice for low, and three times to turn the cooktop lamp off.

Turning on the vent

The vent fan removes steam and other vapors that result from cooking on the rangetop below.

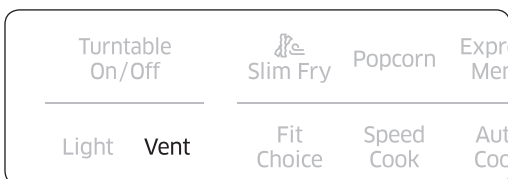

Press the **Vent** button once for high fan speed, twice for medium fan speed, and three times for low fan speed. Press the **Vent** button four times to turn the fan off.

NOTE

The exhaust fan's speed will decrease when the oven's cooking function is activated.

NOTE

The Vent Fan protects the microwave from excess heat rising from the cooktop below it. It automatically turns on if it senses too much heat. If you have turned the fan on, you may find that you cannot turn it off. The fan will automatically turn off when the internal parts are cool. It may stay on for 30 minutes or more after the cooktop and microwave controls are turned off.

Using your microwave oven

Using the warm hold feature

You can keep cooked food warm in your microwave oven for up to 99 minutes and 99 seconds.

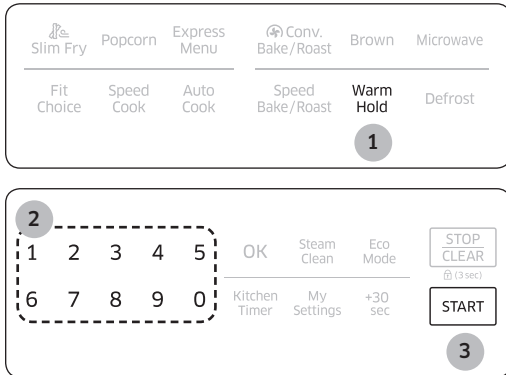

1. Press the **Warm Hold** button.
2. Enter the warm hold time by pressing the **numeric** buttons. If you don't set the time, your oven will maintain the Warm Hold function for 99 minutes.
3. Press the **START** button.

NOTE

Warm Hold operates for up to 99 minutes and 99 seconds.

NOTE

Food that is cooked covered should also be covered during **Warm Hold**.

NOTE

Pastry items (pies, turnovers, etc.) should be uncovered during **Warm Hold**.

NOTE

Complete meals kept warm on a dinner plate can be covered during **Warm Hold**.

Below are the amounts of food we recommend you apply the Warm Hold function to by Food Type.

Food Type	Recommended Quantity
Liquid	1-2 cups
Dry	5-10 oz.

Using the defrost button

Remove all packaging material before defrosting. Place meat, poultry, fish, bread, etc. on a ceramic plate.

General defrosting instructions:



1. Place the food on the turntable (glass tray).
2. Press the **Defrost** button.

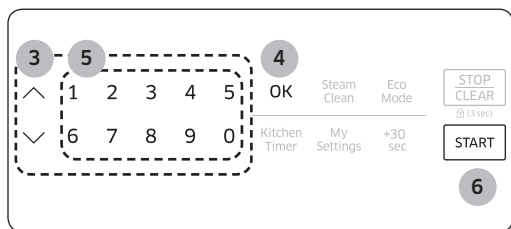

3. To select the number that corresponds to the food you want to defrost, press the **Up&Down** key or one of the **numeric** buttons. (Refer to the below table.)
4. Press the **OK** button.
5. Enter the weight of the food by pressing the **numeric** buttons. (Refer to the table below to see the weights you can enter.)
6. Press the **START** button. The microwave oven will automatically operate for the pre-programmed time.

For specific instructions for different kinds of food, see the table below.

Cook No.	Food	Amount	Standing Time	Remark
1	Meat	0.1~6.0 lbs.	5-10 min	Shield the edges with aluminium foil. Turn the meat over when the oven beeps. This program is suitable for lamb, pork, steaks, chops, and ground meat. For ground meat, place the meat directly on the turntable tray on wax paper. Do not use an extra tray. Let stand, covered with foil, for 5-10 minutes.
2	Poultry	0.1~6.0 lbs.	30-60 min	Shield the leg and wing tips with aluminium foil. Turn the poultry over when the oven beeps. This program is suitable for whole chicken as well as for chicken portions.
3	Fish	0.1~6.0 lbs.	20-60 min	Shield the tail of a whole fish with aluminium foil. Turn the fish over when the oven beeps. This program is suitable for whole fish as well as for fish fillets.
4	Bread	0.1~2.0 lbs.	5-20 min	Put bread on a piece of paper towel. Turn over as soon as the oven beeps. Place cake on a ceramic plate and if possible, turn over as soon as the oven beeps. (The oven keeps operating and stops only when you open the door.) This program is suitable for all kinds of bread, sliced or whole, as well as for bread rolls and baguettes. Arrange bread rolls in a circle.

NOTE

Check food when the oven signals. After the final stage, small sections may still be icy. Let them stand to continue thawing. Food is not fully defrosted until all ice crystals have thawed. Shielding roasts and

steaks with small pieces of foil prevents the edges from cooking before the center of the food has defrosted. Use narrow, flat, smooth strips of aluminum foil to cover the edges and thinner sections of the food.

Using your microwave oven

Accessory usage - Use accessories in the combinations shown below

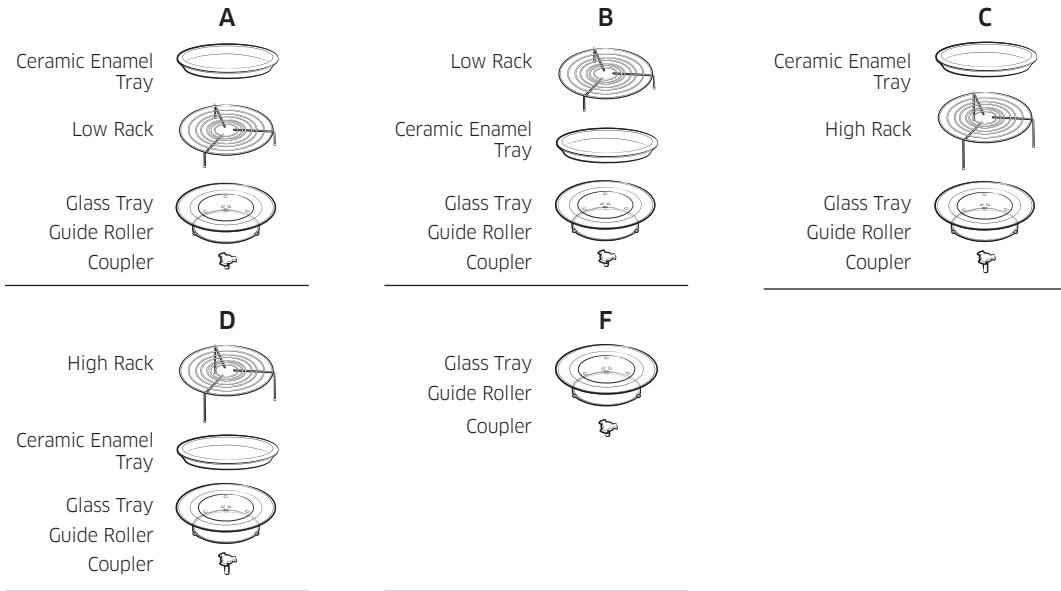

Using the slim fry button

The Slim Fry menu contains pre-set cooking programs for 9 different items. You do not need to set the cooking times or the power level.

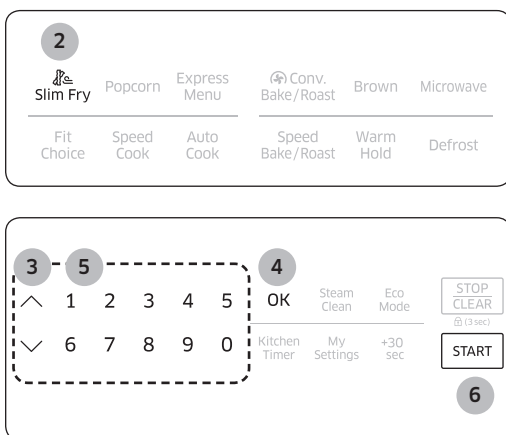

1. Place the food on the tray or the rack. (See Accessory Usage on page 26)
2. Press the **Slim Fry** button.
3. To select the number that corresponds to the food, press the **Up&Down** key or one of the **numeric** buttons. (Refer to the table on the next page.)
4. Press the **OK** button.
5. Enter the amount of food by pressing the **Up&Down** key or one of the **numeric** buttons. (Refer to the table on the next page.)
6. Press the **START** button. The microwave oven will automatically operate for the pre-programmed time.

Cook No.	Food	Amount	Directions	Accessory Type
1	Frozen Oven Chips	2 servings (8 oz, 227 g) 4 servings (16 oz, 454 g)	Place frozen french fries on greased ceramic enamel tray. Place the tray on high rack.	C
2	Frozen Prawns, Breaded	2 servings (8 oz, 227 g) 4 servings (16 oz, 454 g)	Place frozen prawns in ceramic enamel tray. Place the tray on high rack. When the oven beeps, turn prawns over, and then re-start the oven.	C
3	Frozen Chicken Nuggets	1 serving (5 ea) 2 servings (10 ea) (5 ea per serving)	Place chicken nuggets on the ceramic enamel tray. Place the tray on high rack.	C
4	Frozen Mini Spring Rolls	1 serving (6 oz, 170 g) 2 servings (24 oz, 680 g)	Place frozen spring rolls on ceramic enamel tray. Place the tray on high rack.	C
5	Homemade French Fries	2 servings (8 oz, 227 g) 4 servings (12 oz, 340 g)	Peel potatoes and cut into sticks with a thickness of 0.4 x 0.4 inches (10 x 10 mm). Soak in cold water for 30 mins. Dry with a towel, and then brush with ¼ oz (5 g) oil. Place on greased ceramic enamel tray. Place the tray on high rack.	C
6	Frozen Potato Wedges	2 servings (8 oz, 227 g) 4 servings (16 oz, 454 g)	Place frozen potato wedges on greased ceramic enamel tray. Place the tray on high rack.	C
7	Frozen Potato Croquettes	2 servings (8 oz, 227 g) 4 servings (16 oz, 454 g)	Place frozen potato croquettes on greased ceramic enamel tray. Place the tray on high rack. When the oven beeps, turn croquettes over, and then re-start the oven.	C
8	Drumsticks	1 serving (12 oz, 340 g) 2 servings (24 oz, 680 g) (4 pcs per serving)	Rinse drumsticks and place them directly on high rack. Place the high rack on the ceramic enamel tray.	D
9	Sliced Courgettes	2 servings (8 oz, 227 g) 4 servings (16 oz, 454 g)	Cut courgettes and brush with ¼ oz (5 g) oil. Place sliced courgettes on greased ceramic enamel tray. Place the tray on the high rack. When the oven beeps, turn the pieces over, and then re-start the oven.	C

Using your microwave oven

Using the fit choice button

The Fit Choice menu contains pre-set cooking programs for 30 different items. You do not need to set the cooking times or the power level.

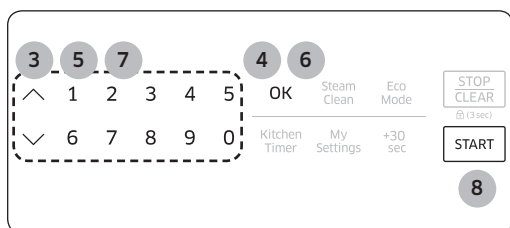

1. Place the food on the tray or the rack. (See Accessory Usage on page 26)
2. Press the **Fit Choice** button.
3. To select the number that corresponds to the category, press the **Up&Down** key or one of the **numeric** buttons. (Refer to the table beginning on the next page.)
4. Press the **OK** button.
5. To select the number that corresponds to the food, press the **Up&Down** key or one of the **numeric** buttons. (Refer to the table beginning on the next page.) After selecting the food, if you do not need to set the amount, press the **START** button. If you need to set the amount, go to Step 6.
6. Press the **OK** button.
7. Enter the amount of food by pressing the **Up&Down** key or one of the **numeric** buttons. (Refer to the table beginning on the next page.)
8. Press the **START** button. The microwave oven will automatically operate for the pre-programmed time.

Category	Cook No.	Food	Amount	Directions	Accessory Type
1 Fresh Vegetables	1	Broccoli	1 serving 2 servings 3 servings 4 servings (1 serving = ½ cup or 5 florets)	Wash and clean broccoli and prepare florets. Put into a microwave-safe ceramic or glass bowl and add ½ to 2 oz (15-60 ml) of water (½ oz or 15 ml per serving). Put bowl in the center of glass tray. Cook covered. Stir after cooking.	F
	2	Carrots	1 serving 2 servings 3 servings 4 servings (1 serving = ½ cup)	Wash and clean carrots and cut into round slices evenly. Put into a microwave-safe ceramic or glass bowl and add ½ to 2 oz (15-60 ml) of water (½ oz or 15 ml per serving). Put bowl in the center of glass tray. Cook covered. Stir after cooking.	F
	3	Green Beans	1 serving 2 servings 3 servings 4 servings (1 serving = ½ cup)	Wash and clean green beans. Put into a microwave-safe ceramic or glass bowl and add ½ to 2 oz (15-60 ml) of water (½ oz or 15 ml per serving). Put bowl in the center of glass tray. Cook covered. Stir after cooking.	F
	4	Spinach	1 serving 2 servings 3 servings 4 servings (1 serving = 1 cup)	Wash and clean spinach . Put into a microwave-safe ceramic or glass bowl and add ½ to 2 oz (15-60 ml) of water (½ oz or 15 ml per serving). Put bowl in the center of glass tray. Cook covered. Stir after cooking.	F
	5	Squash	1-2 lbs (0.5-0.9 kg) 2-3 lbs (0.9-1.4 kg)	Slice squash in half. Put into a microwave-safe ceramic or glass dish cut side down and add ¼ cup (240 ml) water. Put dish in the center of glass tray.	F

Using your microwave oven

Category	Cook No.	Food	Amount	Directions	Accessory Type
2 Frozen Vegetables	1	Broccoli	1 serving 2 servings 3 servings 4 servings (1 serving = ½ cup or 5 florets)	Wash and clean frozen broccoli florets. Put into a microwave-safe ceramic or glass bowl and add ½ to 2 oz (15-60 ml) of water (½ oz or 15 ml per serving). Put bowl in the center of glass tray. Cook covered. Stir after cooking.	F
	2	Carrots	1 serving 2 servings 3 servings 4 servings (1 serving = ½ cup)	Wash and clean frozen sliced carrots. Put into a microwave-safe ceramic or glass bowl and add ½ to 2 oz (15-60 ml) of water (½ oz or 15 ml per serving). Put bowl in the center of glass tray. Cook covered. Stir after cooking.	F
	3	Corn	1 serving 2 servings 3 servings 4 servings (1 serving = ½ cup)	Wash and clean frozen corn. Put into a microwave-safe ceramic or glass bowl and add ½ to 2 oz (15-60 ml) of water (½ oz or 15 ml per serving). Put bowl in the center of glass tray. Cook covered. Stir after cooking.	F
	4	Green Beans	1 serving 2 servings 3 servings 4 servings (1 serving = ½ cup)	Wash and clean frozen green beans. Put into a microwave-safe ceramic or glass bowl and add ½ to 2 oz (15-60 ml) of water (½ oz or 15 ml per serving). Put bowl in the center of glass tray. Cook covered. Stir after cooking.	F
	5	Peas	1 serving 2 servings 3 servings 4 servings (1 serving = ½ cup)	Wash and clean frozen peas. Put into a microwave-safe ceramic or glass bowl and add ½ to 2 oz (15-60 ml) of water (½ oz or 15 ml per serving). Put bowl in the center of glass tray. Cook covered. Stir after cooking.	F

Using your microwave oven

Category	Cook No.	Food	Amount	Directions	Accessory Type
3 Canned Vegetables	1	Carrots	1 serving 2 servings 3 servings 4 servings (1 serving = ½ cup)	Put into a microwave-safe ceramic or glass bowl. Put bowl in the center of glass tray. Cook covered. Stir after cooking.	F
	2	Corn	1 serving 2 servings 3 servings 4 servings (1 serving = ½ cup)	Put into a microwave-safe ceramic or glass bowl. Put bowl in the center of glass tray. Cook covered. Stir after cooking.	F
	3	Green Beans	1 serving 2 servings 3 servings 4 servings (1 serving = ½ cup)	Put into a microwave-safe ceramic or glass bowl. Put bowl in the center of glass tray. Cook covered. Stir after cooking.	F
	4	Peas	1 serving 2 servings 3 servings 4 servings (1 serving = ½ cup)	Put into a microwave-safe ceramic or glass bowl. Put bowl in the center of glass tray. Cook covered. Stir after cooking.	F
	5	Spinach	1 serving 2 servings 3 servings 4 servings (1 serving = 1 cup)	Put into a microwave-safe ceramic or glass bowl. Put bowl in the center of glass tray. Cook covered. Stir after cooking.	F
	6	Beans	1 serving 2 servings 3 servings 4 servings (1 serving = ½ cup or 5 florets)	Put into a microwave-safe ceramic or glass bowl. Put bowl in the center of glass tray. Cook covered. Stir after cooking.	F

Using your microwave oven

Category	Cook No.	Food	Amount	Directions	Accessory Type
4 Grain	1	Oatmeal	1 pack 2 packs	Follow package directions for amount of water. Stir well before and after standing time. Let stand 3-5 minutes.	F
	2	Brown Rice	2 servings 4 servings (1 serving = ½ cup)	Follow package directions for amount of water. Stir well before and after standing time. Let stand 3-5 minutes.	F
	3	Bulgur	2 servings 4 servings (1 serving = ½ cup)	Follow package directions for amount of water. Stir well before and after standing time. Let stand 3-5 minutes.	F
	4	Whole Wheat Macaroni	2 servings 4 servings (1 serving = ½ cup)	Follow package directions for amount of water. Remove from the oven and let stand for 5 minutes. Drain hot water carefully.	F
	5	Quinoa	2 servings 4 servings (1 serving = ½ cup)	Follow package directions for amount of water. Stir well as soon as oven beeps and push start button to continue process.	F
	6	Whole Wheat Couscous	2 servings 4 servings (1 serving = ½ cup)	Follow package directions for amount of water. First pour water into a microwave-safe ceramic or glass bowl and put bowl in the center of glass tray. When the oven beeps, add couscous and re-start the oven. Remove from the oven and let stand for 5 minutes.	F

Using your microwave oven

Category	Cook No.	Food	Amount	Directions	Accessory Type
5 Poultry	1	Chicken Breast	2 pieces 4 pieces (6 oz, 170 g each)	Place chicken breasts on high rack. Place the high rack on ceramic enamel tray. When the oven beeps, turn over chicken breasts and re-start the oven.	D
	2	Bone-in Chicken Pieces	2 servings (18 oz, 510 g) 4 servings (36 oz, 1020 g)	Brush chilled chicken pieces with oil and spices. Put skin-side up on high rack. Place the high rack on ceramic enamel tray.	D
	3	Turkey Breast	4 pieces (12 oz, 340 g - each 3 oz, 85 g)	Place turkey breasts on high rack. Place the high rack on ceramic enamel tray. When the oven beeps, turn over turkey breasts and re-start the oven.	D
	4	Ground Turkey	4 servings (1 lb, 454 g)	Place ground turkey in microwave safe 2 quart casserole glass dish then place on glass tray. When the oven beeps, stir and restart the oven.	F
6 Seafood	1	White Fish Fillet	1 serving (2 pieces, 4 oz, 113 g) 2 servings (4 pieces, 8 oz, 227 g) (1 serving = 2 pcs, each piece = 2 oz, 57 g)	Spray high rack with non stick spray. Place white fillets (cod, pollack etc.) on the high rack. Place the high rack on ceramic enamel tray.	D
	2	Salmon Fillet	1 serving (1 piece, 4 oz, 113 g) 2 servings (2 pieces, 8 oz, 227 g) (1 serving = 1 pc, each piece = 4 oz, 113 g)	Spray high rack with non stick spray. Place salmon fillets on the high rack. Place the high rack on ceramic enamel tray.	D

Using your microwave oven

Category	Cook No.	Food	Amount	Directions	Accessory Type
6 Seafood	3	Tilapia Fillet	1 serving (2 pieces, 4 oz, 113 g) 2 servings (4 pieces, 8 oz, 227 g) (1 serving = 2 pcs, each piece = 2 oz, 57 g)	Spray high rack with non stick spray. Place tilapia fillets on the high rack. Place the high rack on ceramic enamel tray.	D
	4	Tuna Steak	1 serving (1 piece, 4 oz, 113 g) 2 servings (2 pieces, 8 oz, 227 g) (1 serving = 1 pc, each piece = 4 oz, 113 g)	Spray high rack with non stick spray. Place tuna steaks on high rack. Place the high rack on ceramic enamel tray. When the oven beeps, turn over tuna steaks and re-start the oven.	D

Using the popcorn button

You can cook the popcorn easily using Popcorn button. You do not need to set either the cooking times or the power level.

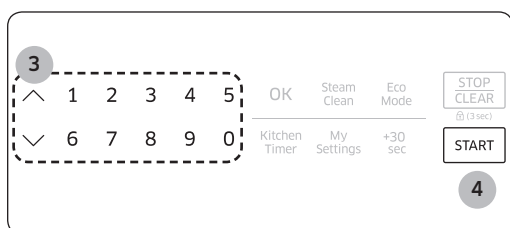

1. Put some food on the tray. (See Accessory Usage on page 26)
2. Press the **Popcorn** button.
3. Enter the amount of food by pressing the **Up&Down** key or one of the **numeric** buttons.

NO.	1	2	3
Amount	3.5 oz (99 g)	3.0 oz (85 g)	1.5 oz (43 g)

4. Press the **START** button.
Then the microwave oven will automatically be operated for pre-programmed time.

Using the speed cook button

The Speed Cook menu contains pre-set cooking programs for 41 different items. You do not need to set the cooking times or the power level.

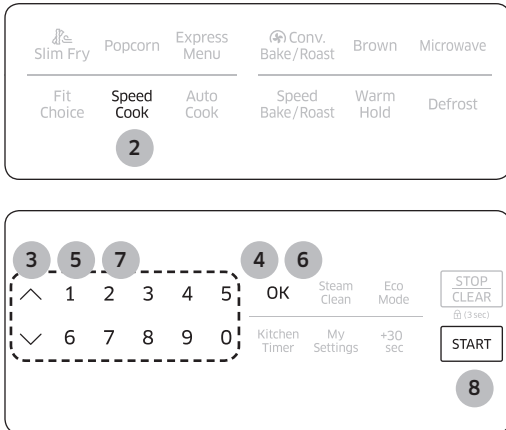

1. Place the food on the tray or the rack.
(See Accessory Usage on page 26)
2. Press the **Speed Cook** button.
3. To select the number that corresponds to the category, press the **Up&Down** key or one of the **numeric** buttons. (Refer to the table beginning on the next page.)
4. Press the **OK** button.
5. To select the number that corresponds to the food, press the **Up&Down** key or one of the **numeric** buttons. (Refer to the table beginning on the next page.) After selecting the food, if you do not need to set the amount, press the **START** button. If you need to set the amount, go to Step 6.
6. Press the **OK** button.
7. Enter the amount of food by pressing the **Up&Down** key or one of the **numeric** buttons. (Refer to the table beginning on the next page.)
8. Press the **START** button. The microwave will automatically operate for the pre-programmed time.

Using your microwave oven

Category	Cook No.	Food	Amount	Directions	Accessory type
1 Breakfast	1	French Toast, Frozen	2 servings 4 servings (1 serving = 1 toast)	Place toast on high rack. Place the high rack on ceramic enamel tray. Turn over when the oven beeps, and re-start the oven.	D
	2	French Toast Sticks	1 serving 2 servings (1 serving = 5 sticks)	Place sticks on the high rack. Place the high rack on ceramic enamel tray. Turn over when the oven beeps, and re-start the oven.	D
	3	Sausage Links, Fresh	2 servings 4 servings (1 serving = 3 links)	Place links on ceramic enamel tray. Place the tray on the high rack. When the oven beeps, turn over sausages and re-start the oven.	C
	4	Sausage Links, Frozen	2 servings 4 servings (1 serving = 3 links)	Place links on ceramic enamel tray. Place the tray on the high rack.	C
	5	Sausage Patties, Frozen	2 servings (4 patties) 4 servings (8 patties) (1 serving = 2 patties)	Place patties on ceramic enamel tray. Place the tray on the high rack.	C
	6	Sausage Patties, Fresh	2 servings (2 patties) 4 servings (4 patties) (1 serving = 1 patties)	Place patties on ceramic enamel tray. Place the tray on the high rack. When the oven beeps, turn over sausages and re-start the oven.	C
	7	Toaster Items	2 servings 4 servings (1 serving = 1 toast)	Place toaster item on high rack. Place the high rack on ceramic enamel tray. Turn over when the oven beeps, and re-start the oven.	D
	8	Waffles, Frozen	2 servings 3 servings (1 serving= 2 waffles)	Place waffles on low rack. Place the low rack on ceramic enamel tray. Turn over when the oven beeps, and re-start the oven.	B

Using your microwave oven

Category	Cook No.	Food	Amount	Directions	Accessory type
2 Poultry	1	Chicken Breast	2 pieces 4 pieces (6 oz, 170 g each)	Place chicken on high rack. Place the high rack on ceramic enamel tray. When the oven beeps, turn over chicken and re-start the oven.	D
	2	Bone-in Chicken Pieces	2 servings (18 oz, 510 g) 4 servings (36 oz, 1020 g)	Place chicken on high rack. Place the high rack on ceramic enamel tray.	D
	3	Whole Chicken	3-4 lbs. (1.4-1.8 kg)	Fold chicken wings under the chicken. Place chicken on low rack. Place the low rack on ceramic enamel tray. Brush chicken with melted butter.	B
	4	Turkey Breast	4 pieces (12 oz, 340 g - each 3 oz, 85 g)	Place turkey breasts on high rack. Place the high rack on ceramic enamel tray. When the oven beeps, turn over turkey breasts and re-start the oven.	D
3 Seafood	1	White Fish Fillet	1 serving (2 pieces, 4 oz, 113 g) 2 servings (4 pieces, 8 oz, 227 g) (1 serving = 2 pcs, each piece = 2 oz, 57 g)	Spray high rack with non stick spray. Place white fillets (cod, pollack etc.) on the high rack. Place the high rack on ceramic enamel tray.	D
	2	Salmon Fillet	1 serving (1 piece, 4 oz, 113 g) 2 servings (2 pieces, 8 oz, 227 g) (1 serving = 1 pc, each piece = 4 oz, 113 g)	Spray high rack with non stick spray. Place salmon fillets on the high rack. Place the high rack on ceramic enamel tray.	D

Using your microwave oven

Category	Cook No.	Food	Amount	Directions	Accessory type
3 Seafood	3	Shrimp, Fresh	2 servings (8 oz, 227 g) 4 servings (16 oz, 454 g)	Place shrimp on ceramic tray. Place the tray on the high rack. When the oven beeps, turn over shrimp and re-start the oven.	C
	4	Tuna Steak	1 serving (1 piece, 4 oz, 113 g) 2 servings (2 pieces, 8 oz, 227 g) (1 serving = 1 pc, each piece = 4 oz, 113 g)	Spray high rack with non stick spray. Place tuna steaks on high rack. Place the high rack on ceramic enamel tray. When the oven beeps, turn over tuna steak and re-start the oven.	D
4 Beef	1	Beef Roast	2 lbs (0.91 kg) 3 lbs (1.36 kg)	Place beef on low rack. Place the low rack on ceramic enamel tray. When the oven beeps, turn over beef and re-start the oven.	B
	2	Top Loin Steak, Medium	1 inch, 0.5 lb. (227 g)	Place steak on high rack. Place the high rack containing the steak on the ceramic enamel tray. When the oven beeps, turn over steak and re-start the oven. Let steak stand for 5 minutes before slicing.	D
	3	Top Loin Steak, Well Done	1 inch, 0.5 lb. (227 g)	Place steak on high rack. Place the high rack containing the steak on the ceramic enamel tray. When the oven beeps, turn over steak and re-start the oven. Let steak stand for 5 minutes before slicing.	D
	4	Top Round Steak, Medium	$\frac{3}{4}$ Inch, 1 lb. (454 g)	Place steak on high rack. Place the high rack containing the steak on the ceramic enamel tray. When the oven beeps, turn over steak and re-start the oven. Let steak stand for 5 minutes before slicing.	D

Using your microwave oven

Category	Cook No.	Food	Amount	Directions	Accessory type
4 Beef	5	Top Round Steak, Well Done	¾ Inch, 1 lb. (454 g)	Place steak on high rack. Place the high rack containing the steak on the ceramic enamel tray. When the oven beeps, turn over steak and re-start the oven. Let steak stand for 5 minutes before slicing.	D
	6	Sirloin Steak, Medium	1 Inch, 1 lb. (454 g)	Place steak on high rack. Place the high rack containing the steak on the ceramic enamel tray. When the oven beeps, turn over steak and re-start the oven. Let steak stand for 5 minutes before slicing.	D
	7	Sirloin Steak, Well Done	1 Inch, 1 lb. (454 g)	Place steak on high rack. Place the high rack containing the steak on the ceramic enamel tray. When the oven beeps, turn over steak and re-start the oven. Let steak stand for 5 minutes before slicing.	D
	8	Ground Beef	2 servings (0.5 lb, 227 g) 4 servings (1 lb, 454 g)	Place beef in microwave safe 2 quart casserole glass dish then place casserole dish on glass tray. When the oven beeps, stir and restart the oven.	F
	9	Hamburgers	2 each (4 oz, 113 g/each) 4 each (4 oz, 113 g/each)	Place hamburgers on ceramic enamel tray. Place the tray on the high rack. When the oven beeps, turn over hamburgers and re-start the oven.	C

Using your microwave oven

Category	Cook No.	Food	Amount	Directions	Accessory type
5 Pork	1	Bone-In Pork Chops	1 serving 2 servings (1 serving = 6-8 oz, 170-227 g each)	Place pork chops on high rack. Place the high rack on ceramic enamel tray. When the oven beeps, turn over pork chops and re-start the oven.	D
	2	Boneless Pork Chops	2 servings (2 ea) 4 servings (4 ea) (1 serving = 4-5 oz, 113-142 g each)	Place pork chops on high rack. Place the high rack on ceramic enamel tray. When the oven beeps, turn over pork chops and re-start the oven.	D
	3	Pork Tenderloin	Small - 1 piece (0.5-1 lb, 227-454 g) Large - 1 piece (1.5-2 lbs, 680-907 g)	Place pork on low rack. Place the low rack containing the pork on the ceramic enamel tray. When the oven beeps, turn over pork and re-start the oven.	B
6 Pizza	1	Frozen Pizza, Individual, 6 Inch	6 inch	Place pizza on low rack. Place the low rack on ceramic enamel tray.	B
	2	Frozen Pizza, Regular, 12 Inch	12 inch	Place pizza on low rack. Place the low rack on ceramic enamel tray.	B
	3	Frozen Individual Deep Dish Pizza	6 inch	Place pizza on low rack. Place the low rack on ceramic enamel tray.	B
	4	Frozen Rising Crust Pizza	12 inch	Place pizza on low rack. Place the low rack on ceramic enamel tray.	B

Using your microwave oven

Category	Cook No.	Food	Amount	Directions	Accessory type
7 Potato	1	Baked Potato	2 ea 4 ea (8-10 oz, 227-283 g/each)	Pierce each potato several times with a fork. Place on the turntable in a spoke-like fashion. After cooking, let the potatoes stand for 3-5 minutes.	F
	2	Sweet Potato	2 ea 4 ea (8-10 oz, 227-283 g/each)	Pierce each sweet potato several times with a fork. Place on the turntable in a spoke-like fashion. After cooking, let the potatoes stand for 3-5 minutes.	F
8 Snacks, Frozen	1	Chicken Nuggets	1 serving (5 ea) 2 servings (10 ea) (5 ea per serving)	Place chicken nuggets on the ceramic enamel tray. Place the tray on the high rack.	C
	2	Chicken Tenders	1 serving (5 ea) 2 servings (10 ea) (5 ea per serving)	Place chicken tenders on the ceramic enamel tray. Place the tray on the high rack.	C
	3	Chicken Wings	2 servings (10 ea) 4 servings (20 ea) (5 wings per serving)	Place chicken wings on low rack. Place the low rack on ceramic enamel tray.	B
	4	Fried Chicken	2 servings 4 servings (1 piece per serving)	Place chicken on ceramic enamel tray. Place the tray on the low rack.	A
	5	Cheese Sticks	2 servings 4 servings (2 sticks per serving)	Place cheese sticks on ceramic enamel tray. Place the tray on the high rack.	C
	6	Onion Rings	2 servings (6 ea) 4 servings (12 ea) (3 rings per serving)	Place onion rings on ceramic enamel tray. Place the tray on the high rack. When the oven beeps, stir and re-start the oven.	C
	7	French Fries	2 servings (6 oz, 170 g) 4 servings (12 oz, 340 g) (3 oz, 85 g per serving)	Place fries on ceramic enamel tray. Place the tray on the high rack. When the oven beeps, stir and re-start the oven.	C

Using your microwave oven

Using the auto cook button

The Auto Cook menu contains pre-set cooking programs for 45 different items. You do not need to set the cooking times or the power level.

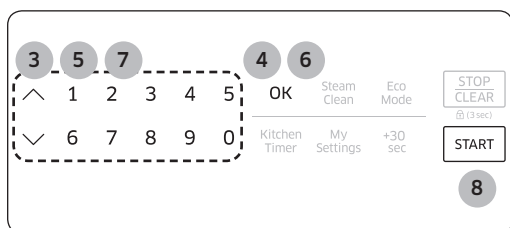
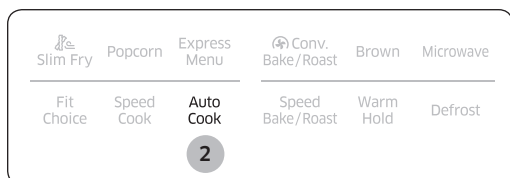

1. Place the food on the tray or the rack. (See Accessory Usage on page 26)
2. Press the **Auto Cook** button.
3. To select the number that corresponds to the category, press the **Up&Down** key or one of the **numeric** buttons. (Refer to the table that begins on the next page.)
4. Press the **OK** button.
5. To select the number that corresponds to the food, press the **Up&Down** key or one of the **numeric** buttons. (Refer to the table that begins on the next page.) After selecting the food, if you do not need to set the amount, press the **START** button. If you need to set the amount, go to Step 6.
6. Press the **OK** button.
7. Enter the amount of food by pressing the **Up&Down** key or one of the **numeric** buttons. (Refer to the table that begins on the next page.)
8. Press the **START** button. The microwave will automatically operate for the pre-programmed time.

Category	Cook No.	Food	Amount	Directions	Accessory type
1 Reheat	1	Soup, Broth	1 to 4 servings (8 oz, 227 g/ serving)	Use only refrigerated food. Pour into a deep ceramic plate or bowl. Cover with lid or vented plastic wrap. Stir well before serving.	F
	2	Soup, Cream	1 to 4 servings (8 oz, 227 g/ serving)	Use only refrigerated food. Pour into a deep ceramic plate or bowl. Cover with lid or vented plastic wrap. Stir well before serving.	F
	3	Pasta	1 to 4 servings (8 oz, 227 g/ serving)	Use only refrigerated food. Pour into a deep ceramic plate or bowl. Cover with lid or vented plastic wrap. Stir well before serving.	F
	4	Casserole	1 to 4 servings (8 oz, 227 g/ serving)	Use only refrigerated food. Pour into a deep ceramic plate or bowl. Cover with lid or vented plastic wrap. Stir well before serving.	F
	5	Dinner Plate	1 serving	Use only pre-cooked, refrigerated food. Put meal on a ceramic plate. Cover plate with vented plastic wrap or wax paper.	F
	6	Beverage	½ cup 1 cup 2 cups	Use measuring cup : do not cover. Place the beverage in the oven. After heating, stir well.	F
	7	Roll	1 to 4 rolls	Put dinner rolls on a microwave-safe ceramic plate. Before serving, let stand 1-2 minutes.	F
	8	Pizza Reheat	2 slices 4 slices (3-4 oz, 85-113 g/each)	Put the pizza on a microwave-safe plate with wide end of slices towards the outside edge of the plate. Do not let slices overlap. Do not cover. Before serving, let stand 1-2 minutes.	F

Using your microwave oven

Category	Cook No.	Food	Amount	Directions	Accessory type
2 Cook	1	Frozen Dinner	8-10 oz (227-283 g) 11-14 oz (312-397 g) 15-18 oz (425-510 g)	Remove package from outerwrapping and follow package instructions for covering and standing. After cooking, let stand 1-3 minutes.	F
	2	Frozen Breakfast	4-6 oz (113-170 g) 7-8 oz (198-227 g)	Remove package from outer wrapping and follow package instructions for covering and standing. After cooking, let stand 1-3 minutes. When the oven beeps, stir and restart the oven.	F
	3	Mashed Potatoes, Instant	2 servings 4 servings (1 serving = $\frac{1}{3}$ cup flakes)	Follow package preparation directions.	F
	4	Bacon, Uncooked	2 slices 4 slices 6 slices	Place 2 paper towels on plate and arrange bacon on towels. Do not overlap. Cover with additional paper towel. Remove paper towel immediately after cooking.	F
	5	Bacon, Pre-Cooked	2 slices 4 slices 6 slices	Place 2 paper towels on plate and arrange bacon on towels. Do not overlap.	F

Using your microwave oven

Category	Cook No.	Food	Amount	Directions	Accessory type
3 Kids Menu	1	Chicken Nuggets	1 serving 2 servings (1 serving = 5 ea)	Place a paper towel on a plate and arrange the nuggets in a spoke-like fashion on the paper towel. Do not cover. Let stand for 1 minute after heating.	F
	2	Hot Dogs	2 each 4 each	Pierce hot dogs, place on plate. When the oven beeps, add buns and re-start the oven.	F
	3	Canned Pasta	1 serving - 7.5 oz (213 g) 2 servings - 15 oz (425 g)	Use only canned pasta at room temperature. Pour into a deep ceramic plate or bowl. Cover with lid or vented plastic wrap. Stir well before serving.	F
	4	Burrito	1 each 2 each	Follow package preparation directions. Let stand for 1-2 minutes after heating.	F
	5	Snack Pocket	1 serving (1 ea) 2 servings (2 ea)	Follow package preparation directions. Let stand for 1-2 minutes after heating.	F
4 Pasta	1	Spaghetti	1 serving (2 oz, 57 g) 2 servings (4 oz, 113 g)	Placed 4 (for 1 serving) or 8 (for 2 servings) cups water in large microwave safe bowl. When the oven beeps, add spaghetti and re-start the oven. Remove from the oven and let stand for 5 minutes. Drain hot water carefully.	F
	2	Macaroni and Cheese	1 serving (1 ea) 2 servings (2 ea)	Follow package preparation directions.	F
	3	Instant Noodles	1 serving (1 ea) 2 servings (2 ea)	Put noodles in microwave safe bowl and pour 2 (for 1 serving) or 4 (for 2 servings) cups water. After cooking, drain water carefully and add seasoning.	F

Using your microwave oven

Category	Cook No.	Food	Amount	Directions	Accessory type
5 Bread	1	Biscuits, Refrigerated	10 ea	Preheat oven to 375 °F. Place biscuits on greased ceramic enamel tray. Place the tray on the low rack.	A
	2	Bread Sticks	12 ea	Preheat oven to 375 °F. Place breadsticks on greased ceramic enamel tray. Place the tray on the low rack.	A
	3	Crescent Rolls, Refrigerated, Small	8 ea	Preheat oven to 375 °F. Place rolls on greased ceramic enamel tray. Place the tray on the low rack.	A
	4	Crescent Rolls, Refrigerated, Large	8 ea	Preheat oven to 375 °F. Place rolls on greased ceramic enamel tray. Place the tray on the low rack.	A
6 Baked Goods	1	Box Cake Mix	½ package	Preheat oven to 350 °F. Pour batter into an 8 inch round cake pan. In the oven, place the filled pan with batter on the low rack.	A (Except ceramic enamel tray)
	2	Cinnamon Rolls	8 ea	Preheat oven to 375 °F. Place buns on greased ceramic enamel tray. Place the tray on the low rack.	A
	3	Brownie Mix	1 package	Preheat oven to 350 °F. Poured batter into an 8 x 8 inch pan, and then place the pan on the low rack.	A
	4	Cookie Dough, Sliced	8 ea (½ inch sliced)	Preheat oven to 350 °F. Place 8 cookies on greased ceramic enamel tray. Place the tray on the high rack.	C
	5	Cookie Dough, Pre Formed	10 ea	Preheat oven to 350 °F. Place 10 cookies on greased ceramic enamel tray. Place the tray on the high rack.	C

Using your microwave oven

Category	Cook No.	Food	Amount	Directions	Accessory type
7 Snacks	1	Quesadilla	1 serving (1 ea) 2 servings (2 ea) (1 serving = 1 ea)	Follow package preparation directions. Let stand for 1-2 minutes after heating.	F
	2	Fish Sticks	2 servings 4 servings (1 serving = 6 sticks)	Preheat oven to 350 °F. Place sticks on low rack, and then place the low rack on the ceramic enamel tray.	B
	3	Nachos 1 Serving	1 serving	Place tortilla chips on plate without overlapping. Sprinkle evenly with cheese. Contents : - 2 cups tortilla chips - 1/3 cup grated cheese	F
	4	Egg Rolls	2 servings (2 ea) 4 servings (4 ea) (1 serving = 1 ea)	Preheat oven to max temp. Place egg rolls on ceramic enamel tray. Place the tray on the high rack.	C
	5	Potato Bites	2 servings (10 ea) 4 servings (20 ea) (1 serving = 5 ea)	Preheat oven to max temp. Place potato bites on ceramic enamel tray. Place the tray on the low rack.	A
	6	Popcorn	1.5 oz (43 g) 3.0 oz (85 g) 3.5 oz (99 g)	Use only one microwave popcorn bag at a time. Be careful when removing the heated bag from the oven and opening it.	F

Using your microwave oven

Category	Cook No.	Food	Amount	Directions	Accessory type
8 Melt/ Soften	1	Melt Butter	1 stick (4 oz, 113 g) 2 sticks (8 oz, 227 g)	Remove wrapping and cut butter in half vertically. Place butter in dish, cover with wax paper. Stir well after finishing and let stand 1-2 minutes.	F
	2	Soften Butter	1 stick (4 oz, 113 g) 2 sticks (8 oz, 227 g)	Remove wrapping and cut butter in half vertically. Place butter in dish, cover with wax paper. Stir well after finishing and let stand 1-2 minutes.	F
	3	Melt Chocolate	1 cup chips	Place chocolate chips in a microwavesafe dish. Stir well at half time when the oven beeps, and re-start the oven. Unless stirred, the chocolate keeps its shape even when heating time is over.	F
	4	Soften Ice Cream	1 pint ½ gallon	Remove top of carton. Place carton in center of microwave oven. Let stand 2 minutes after microwaving.	F
	5	Soften Cream Cheese	1 package (8 oz, 227 g)	Unwrap cream cheese and place on microwave-safe dish. Let stand 1-2 minutes.	F
	6	Soften Frozen Juice	1 package (11.5 oz, 326 g)	Do not place metal juice cans in the microwave. Remove the plastic lid and place in center of microwave. Stir well afterwards.	F
	7	Melt Cheese	1 cup	Place the cheese in a microwave safe bowl and cover with wax paper. Stir well afterwards.	F
	8	Melt Caramel	11 oz (312 g)	Place caramels in a microwavesafe dish. Stir well as soon as finished.	F
	9	Melt Marshmallows	10 oz (283 g)	Place marshmallows in a large microwavesafe dish. Stir well as soon as finished.	F

Using your microwave oven

Using the express menu feature

This feature offers a convenient way to heat food that you cook frequently. You do not need to set either the cooking times or the power level.

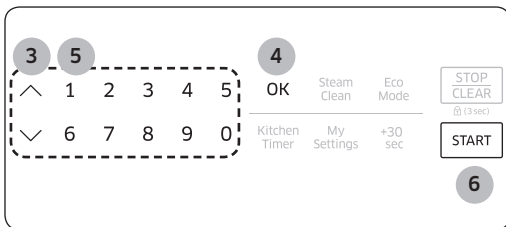
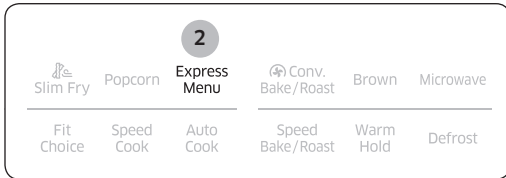

1. Place the food on the turntable. (glass tray)
2. Press the **Express Menu** button.
3. To select the number that corresponds to the food, press the **Up&Down** key or one of the **numeric** buttons. (Refer to the table on the next page.) After selecting the food, if you do not need to set the amount, press the **START** button. If you need to set the amount, go to Step 4.
4. Press the **OK** button.
5. Enter the amount of food by pressing the **Up&Down** key or one of the **numeric** buttons. (Refer to the table on the next page.)
6. Press the **START** button. The microwave will automatically operate for the pre-programmed time.

Using your microwave oven

Cook No.	Food	Amount	Directions	Accessory type
1	Popcorn	3.5 oz (99 g) 3.0 oz (85 g) 1.5 oz (43 g)	Use only one microwave popcorn bag at a time. Be careful when removing the heated bag from the oven and opening it.	F
2	Beverage	½ cup 1 cup 2 cups	Use measuring cup. Do not cover. Place the beverage in the oven. After heating, stir well.	F
3	Baked Potato	2 ea 4 ea (10-13 oz, 280-364 g/each)	Pierce each potato several times with a fork. Place on the turntable in a spoke-like fashion. After cooking, let the potatoes stand for 3-5 minutes.	F
4	Instant Macaroni and Cheese	1 serving 2 servings (1 serving = ⅓ cup flakes)	Follow package preparation directions.	F
5	Reheat Pizza Slices	2 slices 4 slices (3-4 oz, 85-113 g/each)	Put the pizza on a microwave-safe plate with wide end of slice towards the outside edge of the plate. Do not let slices overlap. Do not cover. Before serving, let stand 1-2 minutes.	F
6	Reheat Dinner Plate	1 serving	Use only pre-cooked, refrigerated food. Put meal on a ceramic plate. Cover plate with vented plastic wrap or wax paper.	F
7	Reheat Casserole	1 to 4 servings (8 oz, 227 g/ serving)	Use only refrigerated food. Pour into a deep ceramic plate or bowl. Cover with lid or vented plastic wrap. Stir well before serving.	F
8	Reheat Pasta	1 to 4 servings (8 oz, 227 g/ serving)	Use only refrigerated food. Pour into a deep ceramic plate or bowl. Cover with lid or vented plastic wrap. Stir well before serving.	F
9	Reheat Soup, Broth	1 to 4 servings (8 oz, 227 g/ serving)	Use only refrigerated food. Pour into a deep ceramic plate or bowl. Cover with lid or vented plastic wrap. Stir well before serving.	F

Using your microwave oven

Using the microwave setting cooking times & power levels

Your oven allows you to set two different cooking stages, each with its own time length and power level. The power level lets you control the heating intensity from Warm (1) to High (10).

Power levels

The 10 power levels allow you to choose the optimal power level for your cooking needs.

No.	Power Level	Description	No.	Power Level	Description
1	10	Warm	6	60	Simmer
2	20	Low	7	70	Medium high
3	30	Defrost	8	80	Reheat
4	40	Medium low	9	90	Sauté
5	50	Medium	10	100	High

One-stage cooking

For simple one-stage cooking, you only need to set the cooking time. The power level is automatically set to High. If you want to set the power level to any other level, press **OK** after entering the cooking time, and then use the **numeric** buttons to set the level.



1. Press the **Microwave** button. (You can skip this step and start at the next step.)
2. Use the **numeric** buttons to set a cooking time. You can enter a time from one second to 99 minutes and 99 seconds. To select a time greater than one minute, enter the seconds too. (For example, to set a cooking time of 20 minutes, enter **2, 0, 0, 0**.) If you do not need to set the power level, just press the **START** button. The microwave will automatically operate at the High power level. If you want to change the power level, go to Step 3.

Using your microwave oven

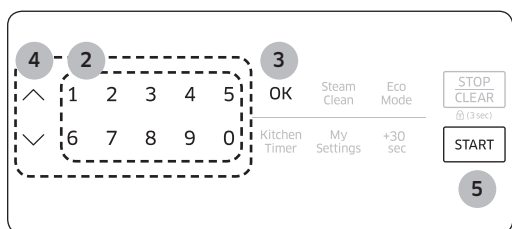

3. If you want to set the power level to a level other than High, press the **OK** button.
4. Press the **Up&Down** key or **numeric** buttons that corresponds to the power level you want to use.
5. Press the **START** button. If you want to add to or reduce the cooking time, use the **Up&Down** key. You can adjust the cooking time while the microwave oven is operating.

Multi-stage cooking (maximum of 2 stages)

Your oven allows you to set two different cooking stages, each with its own time length and power level. The power level lets you control the heating intensity from Warm to High.

1. Follow steps 1, 2, 3, and 4 from the "One-stage cooking" section.
2. Press the **OK** button to move to the second stage.
3. Follow steps 2, 3, 4, and 5 from the "One-stage cooking" section.

Steam cooking guide

You can do some steam cooking using properly accessory by operating the Microwave Mode. Use settings and times in this table as guide lines for steam cooking.

Food	Quantity	Mode	Time (Min)	Instructions
Frozen Vegetable	9 oz (255 g) 18 oz (510 g)	MW 100 %	4-6 8-10	Add water and put the frozen vegetable in a steamer. Cover with lid. After cooking, stand for 2-3 minutes.
Broccoli Florets	9 oz (255 g) 18 oz (510 g)	MW 100 %	3-5 5-7	Rinse and clean fresh broccoli and prepare florets. Add water and put the broccoli in a steamer. Cover with lid. After cooking, stand for 2-3 minutes.

Food	Quantity	Mode	Time (Min)	Instructions
Sliced Carrots	9 oz (255 g) 18 oz (510 g)	MW 100 %	4-5 6-7	Rinse and clean fresh carrots. Add water and put the carrots in the glass steamer. Cover with lid. After cooking, stand for 2-3 minutes.
Cauliflower Florets	9 oz (255 g) 18 oz (510 g)	MW 100 %	3-5 5-7	Rinse and clean fresh cauliflowers and prepare florets. Add water and put the cauliflowers in a steamer. Cover with lid. After cooking, stand for 2-3 minutes.
Peeled Potatoes	9 oz (255 g) 18 oz (510 g)	MW 100 %	4-6 7-9	Rinse and peel the potatoes and cut into a similar size. Add water and put the potatoes in a steamer. Cover with lid. After cooking, stand for 2-3 minutes.
Cubed Pumpkin	9 oz (255 g) 18 oz (510 g)	MW 100 %	7-8 11-13	Weigh the fresh pumpkins, washing and cutting into similar sizes or cubes. Add water and put the pumpkins in a steamer. Cover with lid. After cooking, stand for 2-3 minutes.
Chicken Breast	11 oz (312 g) 22 oz (624 g)	1 st MW 100 % 2 nd MW 40 %	1 st : 1-2 2 nd : 7-8 1 st : 2-3 2 nd : 10-12	Rinse pieces and snick on surface of skin. Add water and put the chicken breasts in a steamer. Cover with lid. After cooking, stand for 2-3 minutes.
Salmon Fillets	11 oz (312 g) 22 oz (624 g)	1 st MW 100 % 2 nd MW 40 %	1 st : 1-2 2 nd : 7-8 1 st : 2-3 2 nd : 8-9	Rinse fish and add 1 tablespoon lemon juice. Add water and put the salmon fillets in a steamer. Cover with lid. After cooking, stand for 2-3 minutes;
Steamed Prawns	11 oz (312 g)	1 st MW 100 % 2 nd MW 40 %	1 st : 1-2 2 nd : 6-8	Rinse the Fresh prawns. Add water and put them in a steamer. Cover with lid. After cooking, stand for 2-3 minutes.

NOTE

You can get the best cooking result when you use Glass Steamer Accessory of SAMSUNG. If you want to buy this glass steamer, please contact the Samsung Call Center on the last page or on-line web site(www.samsungparts.com).

NOTE

If you use other steamer accessory, the result of cooking may be some different with upper Steam Cooking Guide Table.

Using your microwave oven

Brown

Browning adds texture and taste to your food. When browning, use the low or high rack accessory. Use the low rack when the height of food is such that the food would touch the upper heater if placed on the high rack.

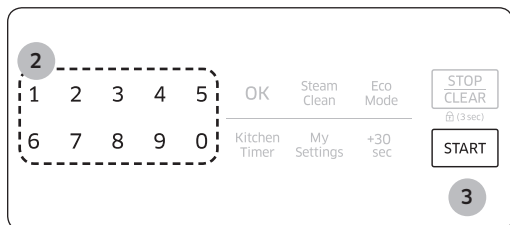

1. Press the **Brown** button.
2. Use the **numeric** buttons to set a cooking time.

NOTE

The maximum cooking time is 60 minutes. Although you can enter a cooking time of more than 60 minutes, your oven will only operate for 60 minutes.

3. Press the **START** button to begin Browning.
 - The vent fan operates at low speed while the oven operates in Browning mode.

Convection bake/roast

The Convection Bake/Roast mode uses dry heat to cook and brown food. A high speed fan circulates hot air inside the oven to heat food quickly and evenly. When you cook using convection, you would generally use the low rack.

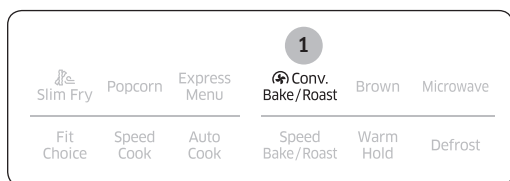

1. Press the **Conv. Bake/Roast** button once for BAKE. Press the **Conv. Bake/Roast** button twice for ROAST.

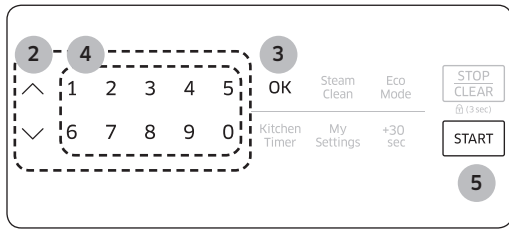

2. To set the temperature, press the **Up&Down** key or one of the **numeric** buttons. (Refer to the temperature table below.)

No/Mode	Bake	Roast
1	100 F	-
2	200 F	200 F
3	250 F	250 F
4	275 F	275 F
5	300 F	300 F
6	325 F	325 F
7	350 F	350 F
8	375 F	375 F
9	400 F	400 F
10	425 F	425 F

3. Press the **OK** button. If you want to preheat the oven, press the **START** button.
4. Use the **numeric** buttons to set a cooking time.

NOTE

The maximum cooking time is 60 minutes. Although you can enter a cooking time of more than 60 minutes, your oven will only operate for 60 minutes.

5. Press the **START** button to begin convection cooking. If you want to add to or reduce the cooking time, use the **Up&Down** key. You can adjust the cooking time while the microwave oven is operating.

NOTE

While operating the oven, if you want to change the temperature setting, press the **Conv.Bake/Roast** button, and then press the **Up&Down** key or one of the **numeric** buttons.

NOTE

To maintain a constant temperature, keep the oven door closed while the food is cooking. Open as infrequently as possible.

Using your microwave oven

Speed bake/roast

The combination cooking feature allows you to cycle automatically between microwave and Bake/Roast cooking. The food will be moist as well as crisp and brown. This type of cooking is ideal for large food that requires long cooking times when prepared in a conventional oven (such as large roasts, whole chickens, etc.). When combination cooking, use the low rack to allow air to circulate completely around the dish.

To use combination cooking:

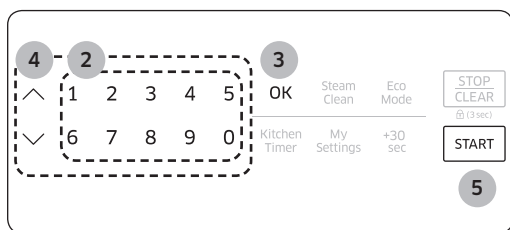
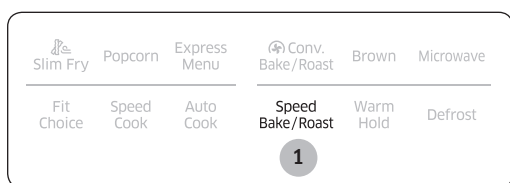

1. Press the **Speed Bake/Roast** button once for SPEED BAKE. Press the **Speed Bake/Roast** button twice for SPEED ROAST.

2. Use the **numeric** buttons to set a cooking time. If you do not need to set the power level, just press the **START** button. The Microwave will operate at a pre-programmed power level. If you want to adjust the power level, go to Step 3.

NOTE

The maximum cooking time is 60 minutes. Although you can enter a cooking time of more than 60 minutes, your oven will only operate for 60 minutes.

3. Press the **OK** button.

4. To set the power level, press the **Up&Down** key or one of the **numeric** buttons. Refer to the table below for the correct button.

No.	1	2	3	4
Power level	10	30	50	70

5. Press the **START** button. If you want to add or reduce the cooking time, use the **Up&Down** key. You can adjust the cooking time while the microwave oven is operating.

NOTE

This mode combines microwave energy with hot air. This combination reduces the cooking time while giving the food a brown and crispy surface.

Cookware for cooking with speed bake/roast

Use only cookware that is specially manufactured for microwave ovens. Do not use metal cookware with this combination mode. Do not use any type of plastic cookware, as it can melt.

Food suitable for speed bake/roast

Other food suitable for this combination mode cooking include all kinds of previously cooked food which needs reheating and browning (e.g. baked pasta), as well as food which requires a short cooking time to brown the top of the food. This mode can also be used for thick food portions that benefit from a browned and crispy top (e.g. chicken pieces, which you turn over half way through cooking). Other food suitable for this cooking mode include a variety of meats and poultry as well as frozen snacks and pizza.

Speed bake/roast cooking guide

Use the cooking mode, power levels, and times in this table as guides for speed cooking.

NOTE

Always use oven gloves when taking the food out of the microwave oven.

Type	Food	Quantity	Mode	Time (Min)	instructions
Pizza	Frozen Pizza, Individual	6 inch	Speed Bake 30 %	12-16	Place the pizza on the low rack, then place the rack on the ceramic enamel tray.
	Frozen Pizza, Regular	12 inch	Speed Bake 30 %	15-21	Place the pizza on the low rack, then place the rack on the ceramic enamel tray.
Meat	Beef Roast (Medium)	2-3 lbs	1 st side Speed Roast 30 % 2 nd side Roast 325 °F	1 st side 25-40 2 nd side 25-40	Brush beef/lamb with oil and spice it with pepper, salt and paprika. Place the roast on the low rack, then place the rack on the ceramic enamel tray. After cooking, wrap in aluminium foil and let stand for 10-15 minutes.

Using your microwave oven

Type	Food	Quantity	Mode	Time (Min)	instructions
Meat	Steaks	0.5-1.0 lb	1 st side Speed Roast 30 % 2 nd side Speed Roast 10 %	1 st side 7-13 2 nd side 10-15	Place the steak on the high rack, then place the rack on the ceramic enamel tray. After cooking, Let the steak rest for 5 minutes before slicing.
	Pork Tenderloin	0.5-1.0 lb	1 st side Speed Roast 30 % 2 nd side Speed Roast 10 %	1 st side 12-18 2 nd side 10-16	Place the pork on the low rack, then place the rack on the ceramic enamel tray. After cooking, Let the steak rest for 5 minutes before slicing.
	Roast Chicken	3-4 lbs	1 st side Speed Roast 50 % 2 nd side Speed Roast 30 %	1 st side 25-40 2 nd side 15-30	Fold the wings under the chicken. Place the chicken on the low rack, then place the rack on the ceramic enamel tray. Brush the chicken with melted butter/oil and seasonings. Put chicken breast side down for the first side, then breast side up for the second.
	Bone-in Chicken pieces	2-4 pieces	1 st side Speed Roast 50 % 2 nd side Brown	1 st side 12-18 2 nd side 10-20	Place the chicken pieces on the high rack, then place the rack on the ceramic enamel tray. Put chicken skin side down for the first side, then skin side up for the second.
Snack, Frozen	Chicken Nuggets	5-10 ea	Speed Roast 30 %	5-10	Place the chicken nuggets on the ceramic enamel tray, then place the tray on the high rack.
	Chicken Wings	10-20 ea	Speed Roast 50 %	12-17	Place the chicken wings on the low rack, then place the rack on the ceramic enamel tray.
	French Fries	6-12 oz	Speed Bake 10 %	10-15	Place the french fries on the ceramic enamel tray, then place the tray on the high rack.

Using your microwave oven

Cookware guide

To cook food in your microwave oven, microwaves must be able to penetrate the food without being reflected or absorbed by the dish.

It is important to choose the correct cookware, therefore look for cookware that is marked microwave-safe.

The following table lists various types of cookware and indicates if and how they should be used in a microwave oven.

Recommended cooking utensils

- **Glass and glass-ceramic bowls and dishes** – Use for heating or cooking.
- **Microwavable plastic wrap** – Use to cover. Leave a small opening for steam to escape and avoid placing it directly on the food.
- **Wax paper** – Use as a cover to prevent spattering.
- **Paper towels and napkins** – Use for short-term heating and covering. They absorb excess moisture and prevent spattering. Do not use recycled paper towels, which may contain metal and can catch fire.
- **Paper plates and cups** – Use for short-term heating at low temperatures. Do not use recycled paper, which may contain metal and can catch fire.
- **Thermometers** – Use only those labeled “Microwave Safe” and follow all directions. Check the food in several places. Conventional thermometers may be used once the food has been removed from the oven.

Limited use items

- **Aluminum foil** – Use narrow strips of foil to prevent overcooking of exposed areas. Using too much foil can damage your oven, so be careful.
- **Ceramic, porcelain, and stoneware** – Use these if they are labeled “Microwave Safe”. If they are not labeled, test them to make sure they can be used safely. Never use dishes with metallic trim.
- **Plastic** – Use only if labeled “Microwave Safe”. Other plastics can melt.
- **Straw, wicker, and wood** – Use only for short-term heating, as they are flammable.

Not recommended

- **Glass jars and bottles** – Regular glass is too thin to be used in a microwave and can shatter.
- **Paper bags** – These are a fire hazard, except for popcorn bags that are designed for microwave use.
- **Styrofoam plates and cups** – These can melt and leave an unhealthy residue on food.
- **Plastic storage and food containers** – Containers such as margarine tubs can melt in the microwave.

Cookware guide

Testing utensils

If you are not sure whether a dish is microwave-safe or not, you can perform this test:

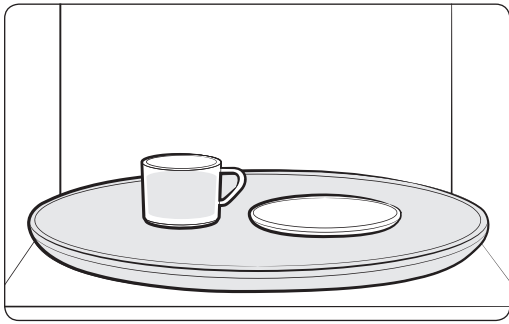

1. Fill a 1 cup glass measuring cup with water and put it inside your oven, next to the dish you want to test.
2. Set the microwave to 1 minute using the **numeric** buttons, and then press the **START** button. This will heat the glass and dish for one minute at High power.

When the microwave stops, the water should be warm and the dish you are testing should be cool.

If the dish is warm, then it is absorbing microwave energy and is not acceptable for use in the microwave.

Cooking guide

Microwave energy actually penetrates food and is attracted to and absorbed by the water, fat, and sugar molecules in the food. The microwaves cause the molecules in the food to move rapidly. The rapid movement of these molecules creates friction and the resulting heat cooks the food.

Cooking techniques

Stirring

Stir foods such as casseroles and vegetables while cooking to distribute heat evenly. Food at the outside of the dish absorbs more energy and heats more quickly, so stir from the outside to the center. The oven will turn off when you open the door to stir your food.

Arrangement

Arrange unevenly shaped foods, such as chicken pieces or chops, with the thicker, meatier parts toward the outside of the turntable where they receive more microwave energy. To prevent overcooking, place thin or delicate parts toward the center of the turntable.

Shielding

Shield food with narrow strips of aluminum foil to prevent overcooking. Areas that need shielding include poultry wing-tips, the ends of poultry legs, and the corners of square baking dishes. Use only small amounts of aluminum foil. Larger amounts can damage your oven.

Turning

Turn foods over midway through cooking to expose all parts to microwave energy. This is especially important with large items such as roasts.

Standing

Food cooked in the microwave builds up internal heat and continues to cook for a few minutes after the oven stops. Let food stand to complete cooking, especially food such as roasts and whole vegetables. Roasts need this time to complete cooking in the center without overcooking the outer areas. All liquids, such as soup or hot chocolate, should be shaken or stirred when cooking is complete. Let liquids stand a moment before serving. When heating baby food, stir well and test the temperature before serving.

Adding Moisture

Microwave energy is attracted to water molecules. Food that is uneven in moisture content should be covered or allowed to stand so that the heat disperses evenly. Add a small amount of water to dry food to help it cook.

Venting

After covering a dish with plastic wrap, vent the plastic wrap by turning back one corner so excess steam can escape.

Cooking guide

Recommended cooking utensils

- Dense foods, such as potatoes, take longer to heat than lighter foods. Food with a delicate texture should be heated at a low power level to prevent it from becoming tough.
- Altitude and the type of cookware you are using can affect cooking time. When trying a new recipe, use the minimum cooking time and check the food occasionally to prevent overcooking.
- Food with a non-porous skin such as potatoes or hot dogs should be pierced to prevent bursting.
- Frying with oil or fat is not recommended. Fat and oil can suddenly boil over and cause severe burns.
- Some ingredients heat faster than others. For example, the jelly inside a jelly doughnut will be hotter than the dough. Keep this in mind to avoid burns.
- Home canning in the microwave oven is not recommended because all harmful bacteria may not be destroyed by the microwave heating process.
- Although microwaves do not heat the cookware, the heat from the food is often transferred to the cookware. Always use pot holders when removing food from the microwave and instruct children to do the same.
- Making candy in the microwave is not recommended as candy can heat to very high temperatures. Keep this in mind to avoid injury.

Guide for cooking eggs in your microwave

- Never cook eggs in the shell and never warm hard-cooked eggs in the shell. They can explode.

- Always pierce whole eggs to keep them from bursting.
- Cook eggs just until set. They become tough if overcooked.

Guide for cooking vegetables in your microwave

- Vegetables should be washed just before cooking. Often, no extra water is needed. If you are cooking dense vegetables such as cubed potatoes, carrots, or green beans, add about $\frac{1}{4}$ cup water.
- Small vegetables (sliced carrots, peas, lima beans, etc.) will cook faster than larger ones.
- Whole vegetables, such as potatoes, acorn squash, or corn on the cob, should be arranged in a circle on the turntable before cooking. They will cook more evenly if turned over after half the cooking time.
- Always place vegetables like asparagus and broccoli with the stem ends pointing towards the edge of the dish and the tips toward the center.
- When cooking cut vegetables, always cover the dish with a lid or vented microwavable plastic wrap.
- Whole, unpeeled vegetables such as potatoes, squash, eggplant, etc., should have their skin pricked in several spots before cooking to prevent them from bursting.
- For more even cooking, stir or rearrange whole vegetables halfway through the cooking time.
- Generally, the denser the food, the longer the standing time. (Standing time refers to the time necessary for dense, large foods and vegetables to finish cooking after they come out of the oven.) A baked potato can stand on the counter for five minutes before cooking is completed, while a dish of peas can be served immediately.

Cleaning and maintaining your microwave oven

Keeping your microwave oven clean improves its performance, wards off unnecessary repairs, and lengthens its life.

Cleaning the exterior

It's best to clean spills on the outside of your microwave oven as they occur. Use a soft cloth and warm, soapy water. Rinse and dry.

CAUTION

Do not get water into the vents. Never use abrasive products or chemical solvents such as ammonia or alcohol as they can damage the appearance of your microwave.

WARNING

Unplug the microwave plug before cleaning.

Cleaning under your microwave oven

Regularly clean grease and dust from the bottom of your microwave using a solution of warm water and detergent.

Cleaning the control panel

Wipe with a damp cloth and dry thoroughly. Do not use cleaning sprays, large amounts of soap and water, abrasives, or sharp objects on the panel as it is easily damaged.

Cleaning the door and door seals

Always ensure that the door seals are clean and that the door closes properly. Take particular care when cleaning the door seals to ensure that no particles accumulate and prevent the door from closing correctly. Wash the glass door with very mild soap and water. Be sure to use a soft cloth to avoid scratching.

NOTE

If steam accumulates inside or outside the oven door, wipe with a soft cloth. Steam can accumulate when you operate the oven when humidity is high and in no way indicates microwave leakage.

Cleaning the interior

CAUTION

To avoid injury, ensure that the microwave oven has cooled down before cleaning it.

CAUTION

Remove the glass tray from the oven when cleaning the oven or tray. To prevent the tray from breaking, handle it with care and do not put it in water immediately after cooking. Wash the tray carefully in warm sudsy water or in the dishwasher.

See the Steam Clean section on page 22.

Cleaning the turntable and roller rings

Clean the roller rings periodically and wash the turntable as required. The turntable can be washed safely in your dishwasher.

Cleaning and maintaining your microwave oven

Storing and repairing your microwave oven

If you need to store your microwave oven for a short or extended period of time, choose a dust-free, dry location. Dust and dampness may adversely affect the functionality of the microwave parts.

⚠ WARNING

Do not repair, replace, or service any part of your microwave oven yourself. Allow only a qualified service technician to perform repairs. If the oven is faulty and needs servicing, or you are in doubt about its condition, unplug the oven from the power outlet and contact your nearest service center.

Do not use the oven if the microwave oven is damaged, in particular, if the door or door seals are damaged or the door does not close properly. This can be caused by a broken hinge, a worn out seal or distorted/bent casing.

Do not remove the oven from its casing. This microwave oven is for home use only and is not intended for commercial use.

Replacing the cooktop/night light

When replacing the cooktop/night light, make sure that you are wearing gloves to avoid injury from the heat of the bulb.

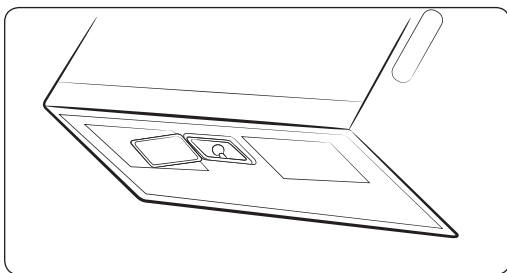

- 1.** Unplug the oven or turn off the power at the main power supply.
- 2.** Remove the screw from the light cover and lower the cover.
- 3.** Replace the bulb with a 40 watt incandescent bulb.
- 4.** Raise the light cover and re-insert the mounting screw.
- 5.** Plug the oven in or turn on the power at the main power supply. Reset the clock.

Replacing the oven light

When replacing the oven light, make sure that you are wearing gloves to avoid injury from the heat of the bulb.

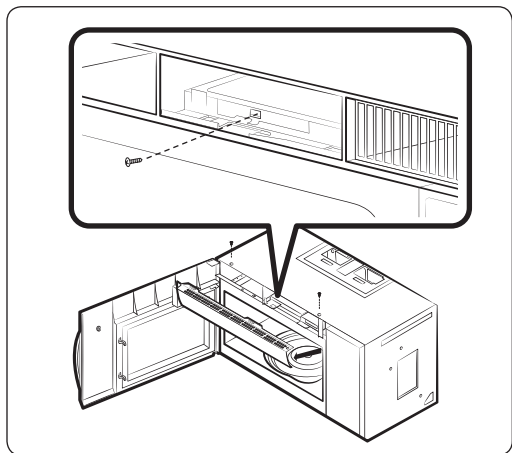

1. Unplug the oven or turn off the power at the main power supply.
2. Open the door.
3. Remove the vent cover mounting screws (2 middle screws).
4. Slide the vent grille to the left, then pull it straight out.
5. Remove the charcoal filter, if present.
6. Remove the screw securing the lamp cover.
7. Remove the bulb by pulling it out gently.
8. Replace the bulb with a 20 watt halogen bulb.
9. Replace the bulb holder.
10. Replace the vent grille and re-insert the 2 screws.
11. Plug the oven in or turn on the power at the main power supply. Reset the clock.

Cleaning and maintaining your microwave oven

Cleaning the grease filter

Your microwave oven has two metal reusable grease filters. The grease filters should be removed and cleaned at least once every four months or as required.

NOTE

Your microwave oven has a filter reminder function. See page 19 for details.

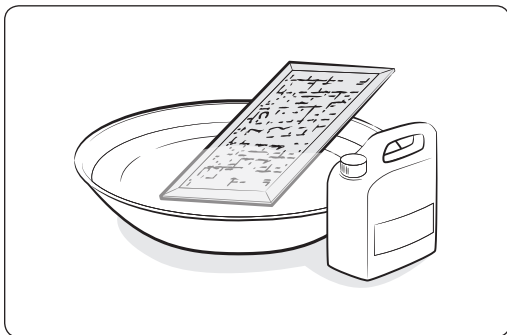
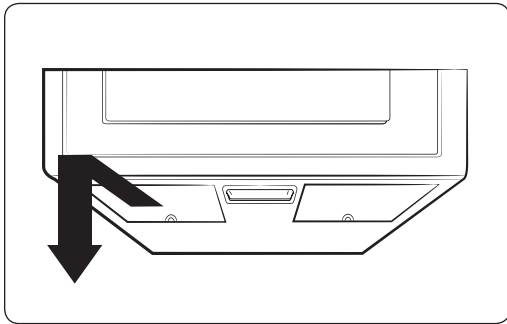

WARNING

To avoid risk of personal injury or property damage, do not operate the oven hood without the filters in place.

- 1.** To remove the filter, slide it to the left (or right) using the tab.
- 2.** Soak the grease filter in hot water and a mild detergent. Rinse well and shake to dry. Brushing the filter lightly can remove embedded dirt.

WARNING

Do not use ammonia or put the grease filter in the microwave oven. The aluminum will darken.

- 3.** To re-install the filter, slide it into the frame slot on the left (or right), and then push it upwards and to the right (or left) to lock it.

Replacing the charcoal filter

If your oven is vented to the inside, the charcoal filter should be replaced every 6 to 12 months and more often if necessary. The charcoal filter cannot be cleaned. To order a new charcoal filter, contact the Parts Department at 1-800-627-4368 or your Samsung dealer. You can also order online at www.samsungparts.com

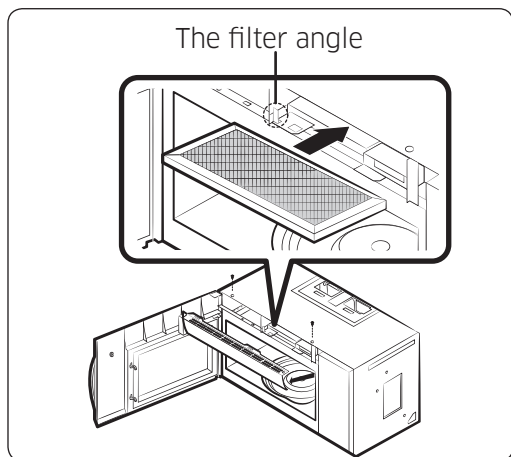
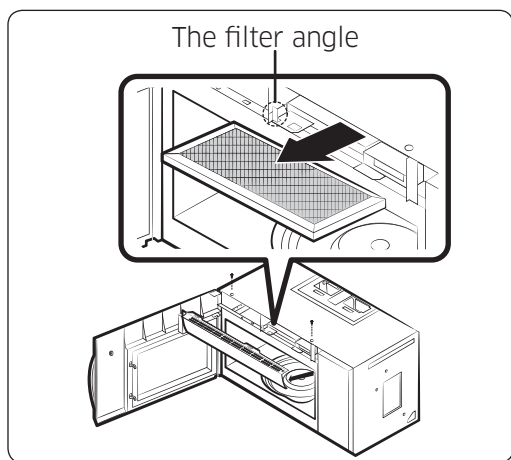

1. Unplug the oven or turn off the power at the main power supply.
2. Open the door.
3. Remove the vent grille mounting screws (2 middle screws).
4. Slide the vent grille to the left, then pull it straight out.
5. Push the hook and remove the old filter.
6. Slide a new charcoal filter into place. The filter should rest at the angle shown.
7. Replace the vent grille and 2 screws and close the door. Plug the oven in or turn on the power at the main power supply. Reset the clock.

Troubleshooting

Check points

If you encounter a problem with your oven, first check the table below and try the recommendations. If a problem persists, or if an information code keeps appearing on the display, contact a local Samsung service center.

Problem	Cause	Action
General		
The buttons cannot be pressed properly.	Foreign matter may be caught between the buttons.	Remove the foreign matter and try again.
	For touch models: Moisture is on the exterior.	Wipe the moisture from the exterior.
	Child lock is activated.	Deactivate Child lock.
The time is not displayed.	Power is not supplied.	Make sure power is supplied. Confirm the microwave is plugged in. Check your fuses or circuit breakers.
	The Eco (power-saving) function is set.	Turn off the Eco function.
The oven does not work.	Power is not supplied.	Make sure power is supplied. Confirm the microwave is plugged in. Check your fuses or circuit breakers.
	The door is open.	Close the door and try again.
	The door open safety mechanisms are covered by foreign matter.	Remove the foreign matter and try again.
The oven stops while in operation.	The user has opened the door to turn food over.	After turning over the food, press the START button again to start operation.
The power turns off during operation.	The oven has been cooking for an extended period of time.	After the oven has cooked for an extended period of time, let the oven cool.
	The cooling fan is not working.	Listen for the sound of the cooling fan.
	Trying to operate the oven without food inside.	Put food in the oven.
	There is not enough ventilation space around the oven.	There are intake/exhaust outlets on the front and rear of the oven for ventilation. Check the installation guide and make sure that the microwave is far enough away from walls and cabinets for proper ventilation.
	Several appliances or devices are plugged into the same outlet.	Unplug all other appliances or devices from the outlet.

Problem	Cause	Action
There is no power to the oven.	Power is not supplied.	Make sure power is supplied. Confirm the microwave is plugged in. Check your fuses or circuit breakers.
There is a popping sound during operation, and the oven doesn't work.	Cooking food in a sealed container or using a container with a tight lid may cause popping sounds.	Do not cook food in sealed containers or in containers with tight lids. Expanding steam from the cooking food can cause the containers to burst or the lids to pop off.
The oven exterior gets too hot during operation.	There is not enough ventilation space around the oven.	There are intake/exhaust outlets on the front and rear of the oven for ventilation. Check the installation guide and make sure that the microwave is far enough away from walls and cabinets for proper ventilation.
	Objects are on top of the oven.	Remove all objects on the top of the oven.
The door cannot be opened properly.	Food residue is stuck between the door and oven interior.	Clean the oven and then open the door.
The oven does not heat.	The oven may not work if too much food is being cooked or improper cookware is being used.	To test the oven, put one cup of water in a microwave-safe container, put the container in the oven, and then run the microwave for 1-2 minutes to check whether the water is heated. If the water is heated, reduce the amount of food and start the function again. Use a cooking container with a flat bottom.
Heating is weak or slow.	The oven may not work if too much food is being cooked or improper cookware is being used.	To test the oven, put one cup of water in a microwave-safe container, put the container in the oven, and then run the microwave for 1-2 minutes to check whether the water is heated. If the water is heated, reduce the amount of food and start the function again. Use a cooking container with a flat bottom.

Troubleshooting

Problem	Cause	Action
The warm function does not work.	The oven may not work if too much food is being warmed or improper cookware is being used.	To test the oven, put one cup of water in a microwave-safe container, put the container in the oven, and then run the microwave for 1-2 minutes to check whether the water is heated. If the water is heated, reduce the amount of food and start the function again. Use a cooking container with a flat bottom.
The thaw function does not work.	The oven may not work if too much food is being thawed or improper cookware is being used.	To test the oven, put one cup of water in a microwave-safe container, put the container in the oven, and then run the microwave for 1-2 minutes to check whether the water is heated. If the water is heated, reduce the amount of food and start the function again. Use a cooking container with a flat bottom.
The interior light is dim or does not turn on.	The door has been left open for a long time.	The interior light may automatically turn off when the Eco function operates. Close and reopen the door or press the STOP/CANCEL button.
	The interior light is covered by foreign matter.	Clean the inside of the oven and check again.
A beeping sound occurs during cooking.	If the Auto Cook function is being used, this beeping sound means it's time to turn over the food.	After turning over the food, press the START button again to restart operation.
The oven is not level.	The oven is installed on an uneven surface.	Make sure the oven is installed on flat, stable surface.
There are sparks during cooking.	Metal containers are used during cooking or thawing.	Do not use metal containers.
When power is connected, the oven immediately starts to work.	The door is not properly closed.	Close the door and check again.
There is electricity coming from the oven.	The power source or power outlet is not properly grounded.	Make sure the power source and power outlet are properly grounded.

Troubleshooting

Problem	Cause	Action
There is water dripping.	Water or steam may be generated by the cooking or defrosting process, depending on the food. This is not an oven malfunction.	Let the oven cool and then wipe with a dry dish towel.
There is steam through a crack in the door.	Water or steam may be generated by the cooking or defrosting process, depending on the food. This is not an oven malfunction.	Let the oven cool and then wipe with a dry dish towel.
There is water left in the oven.	Water or steam may be generated by the cooking or defrosting process, depending on the food. This is not an oven malfunction.	Let the oven cool and then wipe with a dry dish towel.
The brightness inside the oven varies.	Brightness changes depending on power output changes according to function.	Power output changes during cooking are not malfunctions. This is not an oven malfunction.
Cooking is finished, but the cooling fan is still running.	To ventilate the oven, the cooling fan continues to run for about 3 minutes after cooking is complete.	This is not an oven malfunction.
Pressing the START button operates the oven.	This happens when the oven was not operating.	The microwave oven is designed to start operating when you press the START button if it was not operating.
Turntable		
While turning, the turntable comes out of place or stops turning.	There is no roller ring, or the roller ring is not properly in place.	Install the roller ring and then try again.
The turn table drags while turning.	The roller ring is not properly in place, there is too much food, or the container is too large and touches the inside of the microwave.	Adjust the amount of food. Do not use containers that are too large.
The turn table rattles while turning and is noisy.	Food residue is stuck to the bottom of the oven.	Remove any food residue stuck to the bottom of the oven.

Troubleshooting

Problem	Cause	Action
Grill		
Smoke comes out during operation.	During initial operation, smoke may come from the heating elements when you first use the oven.	This is not a malfunction. After you run the oven 2-3 times, it should stop.
	Food is on the heating elements.	Let the oven cool and then remove the food from the heating elements.
	Food is too close to the grill.	Put the food a suitable distance away while cooking.
	Food is not properly prepared and/or arranged.	Make sure food is properly prepared and arranged.
Oven		
The oven does not heat.	The door is open.	Close the door and try again.
Smoke comes out during preheating.	During initial operation, smoke may come from the heating elements when you first use the oven.	This is not a malfunction. After you run the oven 2-3 times, it should stop.
	Food is on the heating elements.	Let the oven cool and then remove the food from the heating elements.
There is a burning smell or a burnt plastic smell when using the oven.	Plastic or non-heat resistant cookware is used.	Use glass cookware suitable for high temperatures.
There is a bad smell coming from inside the oven.	Food residue or plastic has melted and stuck to the interior.	Use the steam function and then wipe the interior of the microwave with a dry cloth. You can put a measuring cup containing a cup of water and a lemon slice inside and run the oven to remove the odor more quickly.
The oven does not cook properly.	The oven door is frequently opened during cooking.	Do not open the door frequently unless you are cooking things that need to be turned. If you open the door often, the interior temperature will be lowered and this may affect the results of your cooking.
	The oven controls are not correctly set.	Set the oven controls correctly and try again.
	The grill or other accessories are not correctly inserted.	Insert the accessories correctly.
	The wrong type or size of cookware is used.	Reset the oven controls or use suitable cookware with flat bottoms.

Information codes

If the oven fails to operate, you may see an information code on the display. Check the table below for the code, and then follow the directions.

Code	Description	Action
C-20	The temperature sensor read the temperature incorrectly.	Press the STOP/CANCEL button and operate again. If it appears again, turn off the microwave oven, let it sit for more than 30 seconds, and then try setting again. If this code re-appears, call your local SAMSUNG Customer Care Center.
C-21	Temperature sensor detects a higher temperature than the setting temperature.	Turn off the microwave oven and let it cool, then try the setting again. If this code re-appears, call your local SAMSUNG Customer Care Center.
C-F0	The microwave has sensed an internal communications failure.	Unplug the power cord of the oven, and contact a local SAMSUNG Customer Care Center.
C-A1	The oven has failed to sense the opening or closing of the damper for 1 minute.	
C-D0	Control buttons are pressed over 10 seconds.	Clean the keys and check if there is water on the surface around key. If it appears again, turn off the microwave oven, let it sit for more than 30 seconds, and then try setting again. If this code re-appears, call your local SAMSUNG Customer Care Center.

Appendix

Specifications

Model	MC17J8000CS
Oven Cavity	1.7 cu ft
Controls	10 power levels, including Defrost
Timer	99 minutes, 99 seconds
Power Source	120 VAC, 60 Hz
Power Consumption	1700 Watt Microwave / 1750 Watt Heater
Microwave Power Output	950 Watts
Cook Top Light	40 Watt incandescent lamp (2 EA)
Oven Light	20 Watt halogen lamp
Oven Cavity Dimensions (inches)	20 ⁹ / ₆₄ "(W) x 10 ⁹ / ₃₂ "(H) x 14"(D)
Outside Dimensions (inches)	29 ⁷ / ₈ " (W) x 16 ¹⁵ / ₁₆ " (H) x 18 ⁹ / ₁₆ "(D)
Shipping Dimensions (inches)	33 ¹¹ / ₃₂ "(W) x 20 ²⁵ / ₃₂ " (H) x 19 ³ / ₈ "(D)
Net/Shipping Weight	74.4 lbs / 86 lbs (33.75 kg / 39 kg)

Warranty

Samsung over-the-range (otr) microwave oven

Limited warranty to original purchaser

This SAMSUNG brand product, as supplied and distributed by Samsung Electronics America, Inc. (SAMSUNG) and delivered new, in the original carton to the original consumer purchaser, is warranted by SAMSUNG against manufacturing defects in materials and workmanship for a limited warranty period of:

ONE (1) YEAR PARTS AND LABOR, TEN (10) YEARS PARTS WARRANTY FOR MAGNETRON

Samsung will charge a repair fee for replacing an accessory or repairing a cosmetic defect if the damage to the unit and/ or damage to or loss of the accessory was caused by the customer. Items this stipulation covers include:

- A Dented, Scratched, or Broken Door, Handle, Out-Panel, or Control Panel
- A Broken or missing Tray, Guide Roller, Coupler, Filter, or Wire Rack

User Replaceable Parts may be sent to the customer for unit repair. If necessary, a Service Engineer can be dispatched to perform service.

This limited warranty begins on the original date of purchase, and is valid only on products purchased and used in the United States. To receive warranty service, the purchaser must contact SAMSUNG for problem determination and service procedures. Warranty service can only be performed by a SAMSUNG authorized service center. The original dated bill of sale must be presented upon request as proof of purchase to SAMSUNG or SAMSUNG's authorized service center.

SAMSUNG will repair this product or replace it if cannot repair it, at our option and at no charge as stipulated herein, with new or reconditioned parts or products if found to be defective during the limited warranty period specified above. All replaced parts and products become the property of SAMSUNG and must be returned to SAMSUNG. Replacement parts and products assume the remaining original warranty, or ninety (90) days, whichever is longer.

In-home service will be provided during the warranty labor period subject to availability within the contiguous United States. In-home service is not available in all areas. To receive in-home service, the product must be unobstructed and accessible to service personnel. If during in-home service repair can not be completed, it may be necessary to remove, repair and return the product. If in-home service is unavailable, SAMSUNG may elect, at our option, to provide for transportation of our choice to and from a SAMSUNG authorized service center. Otherwise, transportation to and from the SAMSUNG authorized service center is the responsibility of the purchaser.

Warranty

This limited warranty covers manufacturing defects in materials and workmanship encountered in normal, noncommercial use of this product and shall not apply to the following, including, but not limited to: damage which occurs in shipment; delivery and installation; applications and uses for which this product was not intended; altered product or serial numbers; cosmetic damage or exterior finish; accidents, abuse, neglect, fire, water, lightning or other acts of nature; use of products, equipment, systems, utilities, services, parts, supplies, accessories, applications, installations, repairs, external wiring or connectors not supplied or authorized by SAMSUNG which damage this product or result in service problems; incorrect electrical line voltage, fluctuations and surges; customer adjustments and failure to follow operating instructions, cleaning, maintenance and environmental instructions that are covered and prescribed in the instruction book; problems caused by pest infestations, and overheating or overcooking by user; glass tray or turntable; reduced magnetron power output related to normal aging. SAMSUNG does not warrant uninterrupted or error-free operation of the product.

THERE ARE NO EXPRESS WARRANTIES OTHER THAN THOSE LISTED AND DESCRIBED ABOVE, AND NO WARRANTIES WHETHER EXPRESS OR IMPLIED, INCLUDING, BUT NOT LIMITED TO, ANY IMPLIED WARRANTIES OF MERCHANTABILITY OR FITNESS FOR A PARTICULAR PURPOSE, SHALL APPLY AFTER THE EXPRESS WARRANTY PERIODS STATED ABOVE, AND NO OTHER EXPRESS WARRANTY OR GUARANTY GIVEN BY ANY PERSON, FIRM OR CORPORATION WITH RESPECT TO THIS PRODUCT SHALL BE BINDING ON SAMSUNG. SAMSUNG SHALL NOT BE LIABLE FOR LOSS OF REVENUE OR PROFITS, FAILURE TO REALIZE SAVINGS OR OTHER BENEFITS, OR ANY OTHER SPECIAL, INCIDENTAL OR CONSEQUENTIAL DAMAGES CAUSED BY THE USE, MISUSE OR INABILITY TO USE THIS PRODUCT, REGARDLESS OF THE LEGAL THEORY ON WHICH THE CLAIM IS BASED, AND EVEN IF SAMSUNG HAS BEEN ADVISED OF THE POSSIBILITY OF SUCH DAMAGES. NOR SHALL RECOVERY OF ANY KIND AGAINST SAMSUNG BE GREATER IN AMOUNT THAN THE PURCHASE PRICE OF THE PRODUCT SOLD BY SAMSUNG AND CAUSING THE ALLEGED DAMAGE. WITHOUT LIMITING THE FOREGOING, PURCHASER ASSUMES ALL RISK AND LIABILITY FOR LOSS, DAMAGE OR INJURY TO PURCHASER AND PURCHASER'S PROPERTY AND TO OTHERS AND THEIR PROPERTY ARISING OUT OF THE USE, MISUSE OR INABILITY TO USE THIS PRODUCT SOLD BY SAMSUNG NOT CAUSED DIRECTLY BY THE NEGLIGENCE OF SAMSUNG. THIS LIMITED WARRANTY SHALL NOT EXTEND TO ANYONE OTHER THAN THE ORIGINAL PURCHASER OF THIS PRODUCT, IS NONTRANSFERABLE AND STATES YOUR EXCLUSIVE REMEDY.

Some states do not allow limitations on how long an implied warranty lasts, or the exclusion or limitation of incidental or consequential damages, so the above limitations or exclusions may not apply to you. This warranty gives you specific legal rights, and you may also have other rights which vary from state to state.

To obtain warranty service, please contact SAMSUNG at:

1-800-SAMSUNG (726-7864) or www.samsung.com/us/support

Memo

Memo

Memo
