

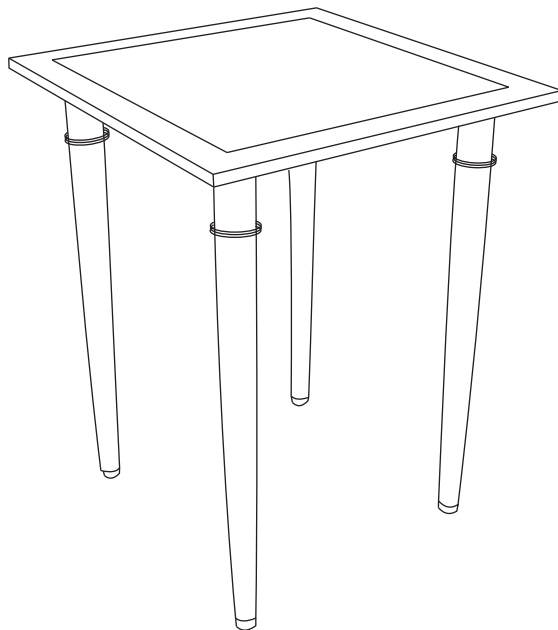

Item # 739 160
Model # 176-411-28BT

USE AND CARE GUIDE

OAK CLIFF 28 INCH SQUARE STEEL STAMPED TOP BISTRO TABLE



Questions, problems, missing parts? Before returning to the store,
call Hampton Bay Customer Service
8.00 a.m. - 7.00 p.m. EST, Monday - Friday,
9.00 a.m. - 6.00 p.m. EST, Saturday

1-855-HD-HAMPTON

HAMPTONBAY.COM



THANK YOU

We appreciate the trust and confidence you have placed in Hampton Bay through the purchase of this bistro table. We strive to continually create quality products designed to enhance your home. Visit us online to see our full line of products available for your home improvement needs. Thank you for choosing Hampton Bay!

Table of Contents

Table of Contents.....	2	Pre-Assembly	3
Safety Information.....	2	Planning Assembly	3
Warranty	2	Hardware Included.....	3
Two Year Frame Limited Warranty.....	2	Package Contents	4
What Is Covered	2	Assembly	5
What Is Not Covered	2		
Care Instructions	2		

Safety Information

-  **CAUTION:** Please keep children out of the assembly area during assembly.
-  **WARNING:** Do not sit or stand on the table.
-  **CAUTION:** Use the table on flat ground only.

Warranty

TWO YEAR FRAME LIMITED WARRANTY

WHAT IS COVERED

We warrant the frame to be free of manufacturing defects to the original purchaser for two years.

WHAT IS NOT COVERED

It remains the customer's responsibility for freight and packaging charges to and from our service center. This warranty does not cover commercial use, hardware, acts of nature, fire, freezing and abusive use. In addition, purchased parts are not covered under this warranty. We reserve the right to make substitutions with similar merchandise, if the model in question is no longer in production.

Care Instructions

Before using, wipe with a clean, dry cloth. Do not use bleach or solvents. Treat the frame with liquid wax for maximum protection against UV light and salty, damp air. When not in use, store the furniture in a cool, dry place. If your set includes cushions or mesh fabric, they may be cleaned by hand with a mild solution of soap and water. Rinse the cushions thoroughly and allow to drip dry. Do not machine wash or tumble dry, as the cushions may shrink. Do not use bleach or solvents on fabrics. When cleaning the tabletop make sure to use a soft, clean cloth that doesn't bleed color.

You may contact our customer service department with any questions by phone at 1-855-HD-HAMPTON or visit www.hamptonbay.com.

Pre-Assembly

PLANNING ASSEMBLY

It will take two people about 10 minutes to complete the assembly process.

HARDWARE INCLUDED



NOTE: Hardware not shown to actual size.



____ AA



____ BB



____ CC



____ DD

Part	Description	Quantity
AA	Bolt cap (M6)	12
BB	Bolt (M6x15)	12
CC	Washer (M6)	12
DD	Hex wrench	1

Pre-Assembly (continued)

PACKAGE CONTENTS

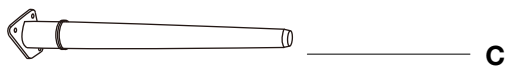
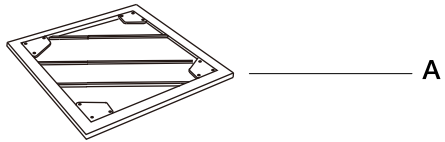

Part	Description	Quantity
A	Table top	1
B	Table leg	2
C	Table leg	2

Assembly

1 Attaching table legs

- Place the table top (A) upside down on a flat, smooth surface.
- Align table legs (B) and (C) to the table top.
- Attach each leg (B) / (C) to the table top (A) with washers (CC) and bolts (BB), using hex wrench (DD).
- Completely tighten all the bolts (BB) when all bolts are in place.
- Cover all the bolts (BB) with bolt caps (AA).

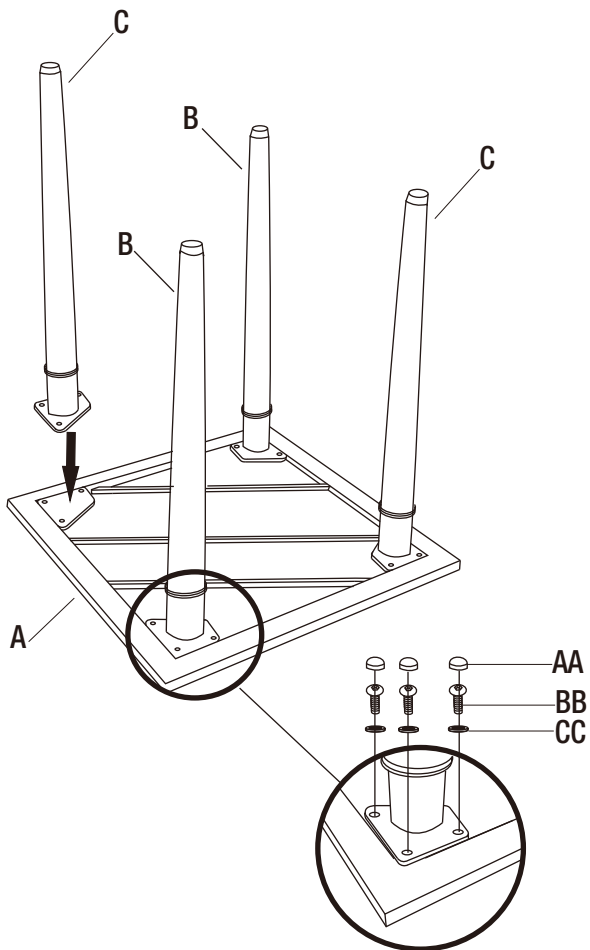

2 Stabilizing the table

- Turn the table upright.
- Level the table with foot glides at the bottom of table legs.





Questions, problems, missing parts? Before returning to the store,
call Hampton Bay Customer Service
8.00 a.m. - 7.00 p.m. EST, Monday - Friday,
9.00 a.m. - 6.00 p.m. EST, Saturday

1-855-HD-HAMPTON

HAMPTONBAY.COM

Retain this manual for future use.