

# Table of Contents

<b>Original</b> .....	<b>2 – 9</b>
Seal-Tite Cross Bed Boxes, Side Bin .....	2
Chests, Challenger Single Lid Cross Bed .....	3
Challenger Gull-Wing Cross Bed, Low Profile Single Lid Cross Bed.....	4
C-Channel Brite Boxes .....	4
Challenger Specialty Boxes, Storage Boxes, Side Bin .....	5
Challenger Underbed, Topside Storage Boxes, Trailer Utility Boxes .....	6
Hand-Tote Storage Boxes .....	6
ATV Storage Boxes, CBT Storage System .....	7
Ultima Cross Bed, Ultima Gull-Wing Cross Bed Storage Boxes .....	8
Contender Cross Bed Boxes, Storage Box Accessories .....	9
<b>Aluminum</b> .....	<b>10 – 23</b>
Standard Box Overview and Features .....	10
Standard Cross Bed Boxes .....	11
Low Profile Cross Beds, Gull-Wing Cross Beds.....	12
ECL Cross Beds.....	13
Flush Mount Side Boxes, Side Bin Boxes .....	14
Chest / Flush Mount Boxes .....	15
Top Mount Boxes, Rail Top Mount.....	16
Fender Well Boxes, Fender Well Gun Boxes, 5th Wheel Box .....	17
Dog Boxes, Heavy-Duty Coolers .....	18
Tower Box, Utility Vehicle Boxes, Hand-Held Toolboxes.....	19
Underbody Boxes, Adjustable Shelf Inserts.....	20
Commercial Trucking Underbody & In-Frame Boxes.....	21
Liquid Storage Tanks .....	22
Trailer Tongue Boxes, Hitch Cargo Carrier & Receiver Boxes .....	23
<b>Steel</b> .....	<b>24 – 29</b>
Steel Overview and Features .....	24
Steel Cross Bed Boxes .....	25
Fender Well & Side Bin Boxes, Flush Mount Boxes .....	26
Top Mount Boxes, Trailer Tongue Boxes .....	27
Underbody Boxes.....	28
Liquid Storage Tanks .....	29
<b>Structured Foam Lid (SFL) Series</b> .....	<b>30</b>
SFL Series Cross Beds, SFL Series Flush Mounts .....	30
<b>PRO Series</b> .....	<b>31 – 34</b>
Commercial PRO HD Cross Bed Boxes .....	31
Commercial PRO HD Side Bin Boxes.....	32
Commercial PRO Steel Window Grill and Headache Rack .....	33
Job Site Boxes, Job Chest.....	34
<b>PRO Steel</b> .....	<b>35</b>
Commercial PRO Steel Cross Bed Boxes .....	35
<b>Accessories</b> .....	<b>36</b>
<b>Armor-X™ Coating</b> .....	<b>37 – 41</b>
Armor-X Coating: Cross Bed Boxes, Flush Mount Box .....	38
Armor-X Coating: Tongue Boxes, Liquid Storage Tanks .....	39
Armor-X Coating: Job Site Box, Underbody Boxes.....	40
In-Store Displays .....	41

# Truck Tool and Storage Box Solutions

## Handcrafted, Developed with the Professional Contractor in Mind

### Seal-Tite Storage Boxes

Industrial grade boxes are designed to endure and perform. Aerodynamic, domed-lid design adds extra strength and durability. Available in bright .080 diamond tread aluminum or smooth .070 polished aluminum finishes.

- Durable, premium diamond tread aluminum construction
- Easy access with self-rising lid
- Convenient push button entry for single-handed box entry
- Weather-resistant seals keep moisture out
- Quick no drill installation (hardware included)
- Backed by LUND's Limited Lifetime Warranty



### Seal-Tite Single Lid Cross Bed Boxes

High-domed-lid roof offers additional storage room, while providing under the box clearance for full bed utilization.

- Convenient side pocket organizers
- Deep, four-section sliding tray
- Weather-resistant seal keeps moisture out

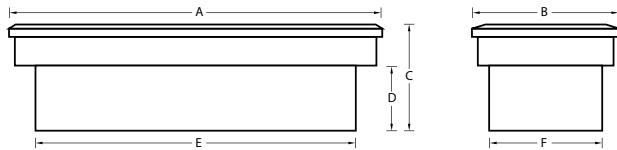

MODEL	DESCRIPTION	STYLE	CUBIC FT	SIZE	DIMENSIONS IN INCHES					
					A	B	C	D	E	F
07000	72" Cross Bed Box	Polished	13.50	Full	71.75	21.00	17.88	8.75	61.00	18.00
07100	72" Cross Bed Box	Polished	16.90	Full	71.25	26.75	17.88	11.31	61.00	24.00
07099*	74" Cross Bed Box	Polished	12.10	Full	73.50	21.00	15.88	8.75	63.00	18.00
07800	72" Cross Bed Box	Diamond	10.80	Mid	71.25	21.00	14.75	8.75	61.00	18.00
07800DB	72" Cross Bed Box	Diamond	13.70	Full	71.25	21.00	19.75	14.75	61.00	18.00
07899**	74" Cross Bed Box	Diamond	12.10	Full	73.50	21.00	15.88	8.75	63.00	18.00

\*WILL NOT FIT 5.8' Bed, Fits Ford Super Duty only

\*\*Fits Ford Super Duty only

### Seal-Tite Side Bin

Mounts to the inside of truck bed side rails, providing extra storage room and easy access to tools and equipment.

- Keyed locks protect valuables
- Convenient push button entry for single-hand use
- Available in sizes: 48", 60" and 88"

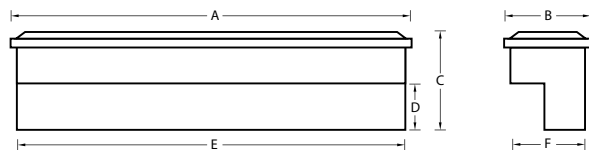

MODEL	DESCRIPTION	STYLE	CUBIC FT	SIZE	DIMENSIONS IN INCHES					
					A	B	C	D	E	F
07300	59" Side Bin Box	Polished	8.40	Full	58.75	15.75	14.00	7.50	58.00	10.56
07400	88" Side Bin Box	Polished	12.10	Full	87.75	15.75	14.00	7.50	87.00	10.56
07946	48" Side Bin Box	Diamond	5.20	Full	47.00	12.88	13.00	7.75	46.13	9.00
07959	59" Side Bin Box	Diamond	8.40	Full	58.75	15.75	14.00	7.50	58.00	10.56

## Seal-Tite Chests

Flush-mount design provides safe, unobstructed view of the road. Angled bottom design at front and side walls accommodate sloped bed walls and wheel wells. Offset lid construction allows lids to fully open.

- Weather-sealed domed-lid
- Triple O-ringed push-button sealed locks, for weatherproof security

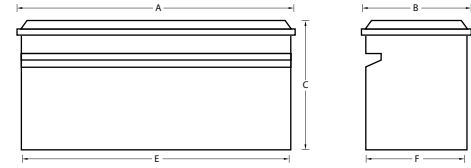

MODEL	DESCRIPTION	STYLE	CUBIC FT	SIZE	DIMENSIONS IN INCHES					
					A	B	C	D	E	F
07500	60" RV Storage Chest	Polished	16.00	Full	60.75	20.75	22.19	0	60.00	20.00
07600	60" Slant Storage Chest	Polished	13.10	Full	60.75	20.38	18.50	0	60.00	16.50
07700	60" Jumbo Storage Chest	Polished	18.80	Full	60.75	28.56	19.00	0	60.00	28.50
07950	60" RV Storage Chest	Diamond	16.00	Full	60.75	20.75	22.19	0	60.00	20.00

## Challenger Storage Boxes

Strength and functionality, critical to the professional, are standard across the Challenger™ line of storage boxes.

- Structured foam-filled lids add extra strength and durability
- Easy access with self-rising lid
- Lockable, quick-release stainless paddle handles
- Weather-resistant seals keep moisture out
- Hand welded for durability and strength
- Quick no drill installation (hardware included)
- Backed by LUND's Limited Lifetime Warranty
- Latch cover encloses locking system, helping to prevent box content damage or lock interference.



## Challenger Single Lid Cross Bed Boxes

Features a long, single-lid design, ideal for storage of sporting goods, camping equipment, or bulky tools. Clearance under the box allows for additional use of the truck bed for oversized cargo.

- Convenient side pockets
- Heavy-duty sliding, lockable tool tray
- Non-skid rubber floor mat and installation kit included
- Features 2 built in tool holders

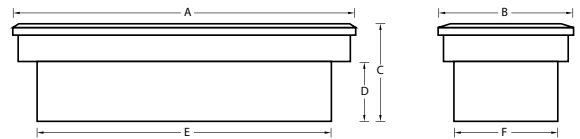

MODEL	DESCRIPTION	STYLE	CUBIC FT	SIZE	DIMENSIONS IN INCHES						
					A	B	C	D	E	F	G
5350	60" Single Lid Cross Bed Box	Brite	10.00	Mid	60.25	20.50	14.00	8.75	51.50	18.00	—
5350SB	60" Single Lid Cross Bed Box	Brite	10.30	Mid	60.25	20.50	14.00	8.75	42.44	18.00	4.13
5400	70" Single Lid Cross Bed Box	Brite	11.70	Full	70.25	20.50	14.00	8.75	61.50	18.00	—
5400DB	70" Single Lid Deep Cross Bed Box	Brite	15.60	Full	70.25	20.50	17.75	12.38	61.50	18.00	—
75400	70" Single Lid Cross Bed Box	Black	11.70	Full	70.25	20.50	14.00	8.75	61.50	18.00	—
75400DB	70" Single Lid Deep Cross Bed Box	Black	15.60	Full	70.25	20.50	17.75	12.38	61.50	18.00	—
5499	74" Single Lid Cross Bed Box	Brite	12.00	Full	73.75	20.50	14.00	8.75	63.25	18.00	—
5900*	64" Single Lid Cross Bed Box	Brite	10.30	Mid	63.25	20.50	14.00	8.75	53.00	18.00	—

\* Will not fit '08 Dakota with rail system, Dodge Dakota Quad Cab, Chevy Colorado/GMC Canyon Crew Cab  
'05-'12 Toyota Tacoma, Extended and Crew Cab will need part #954102

## Challenger Gull-Wing Cross Bed Boxes

Offers quick and easy access to tools and equipment. The twin-lid design locks from either side and is ideal for safe storage.

- Lid locks from either side for extra security
- Easy access with self-rising lid
- Available in a deep box configuration

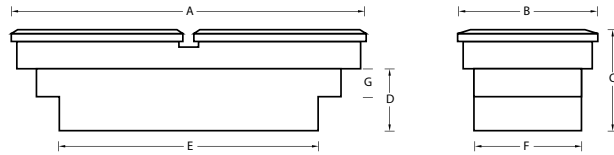
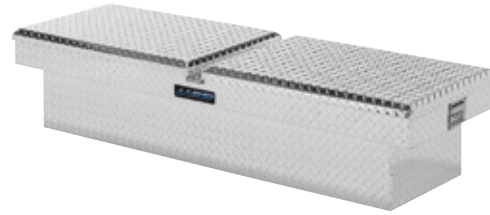

MODEL	DESCRIPTION	STYLE	CUBIC FT	SIZE	DIMENSIONS IN INCHES					
					A	B	C	D	E	F
5150	70" Gull-Wing Cross Bed	Brite	9.40	Full	70.25	20.50	14.00	8.75	61.25	18.00
5150DB	70" Gull-Wing Cross Bed Deep Box	Brite	9.70	Full	70.25	20.50	17.75	12.38	61.25	18.00
5950*	64" Gull-Wing Cross Bed Box	Brite	9.10	Mid	63.25	20.50	14.00	8.75	54.50	18.00

\* Will not fit '08 Dakota with rail system, Chevy/GMC Colorado/Canyon Crew Cab  
 '05-'12 Toyota Tacoma Extended Cab and Crew Cab need part # 954102

## Challenger Low Profile Single Lid Cross Bed Boxes

Provides maximum rear window visibility and is ideal for storage of sporting goods, camping equipment, or bulky tools. Designed to fit most full-size trucks allowing storage underneath box.

- Lockable, quick-release stainless handles
- Available for full and downsized trucks
- Weatherproof gasket prevents leakage

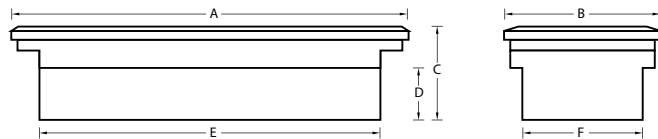

MODEL	DESCRIPTION	STYLE	CUBIC FT	SIZE	DIMENSIONS IN INCHES					
					A	B	C	D	E	F
5400LP	70" Single Lid Low Profile	Brite	12.00	Full	70.25	20.50	14.00	10.75	61.50	18.00
75400LP	70" Single Lid Low Profile	Black	12.00	Full	70.25	20.50	14.00	10.75	61.50	18.00
5420LP	70" Single Lid Low Profile	Brite	9.80	Full	70.25	12.50	18.25	14.63	59.50	9.81
75420LP	70" Full-Size Trucks, Deep Box	Black	9.50	Full	70.25	12.50	18.25	12.38	59.50	9.81
5900LP*	99-12 Full-Size Trucks, Ford SD	Brite	10.80	Mid	63.25	20.50	14.00	10.75	54.50	18.00

\* Will not fit '08 Dakota with rail system, Chevy/GMC Colorado/Canyon Crew Cab  
 '05-'12 Toyota Tacoma Extended Cab and Crew Cab will need part # 954102

## C-Channel Boxes

These twin-lid style boxes offer quick and easy access to tools and equipment from both the sides and bed of your truck—opening from the back of the cab.

- Auto lift gas strut provides one-handed use
- Easy grip, 3-finger paddle handles
- Lockable from both sides
- Twin lids open away from truck bed for easy access to larger stored items

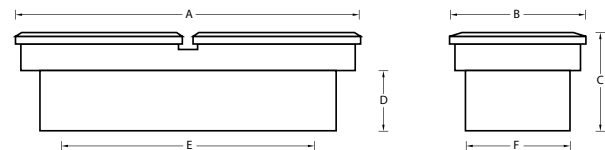

MODEL	DESCRIPTION	SIZE	CUBIC FT	DIMENSIONS IN INCHES					
				A	B	C	D	E	F
5200	70" Dual Lid C-Channel	Full	11.70	70.25	20.50	14.00	8.75	61.50	18.00

## Challenger Specialty Boxes

Constructed with heavy-duty diamond tread aluminum walls and hand-welded for strength and durability. Each box is protected with easy grip, 3-finger paddle handles with lockable stainless steel latches – ideal for keeping valuable tools, and equipment out of sight – safe and secure.

- Self-rising lid allows easy access
- Brite aluminum or black powder coat finishes
- No-drill, heavy-duty J-bolt mounting hardware



## Chest Storage Boxes

Extra roomy, designed to keep valuables safe and secure.

- Brite aluminum or black powder coat finishes
- Ultimate security with quick release, stainless steel paddle handle lever-locking system

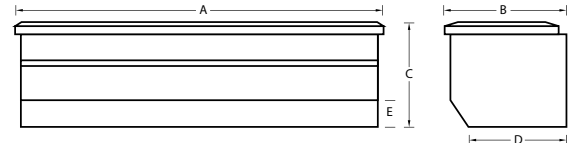

MODEL	DESCRIPTION	STYLE	CUBIC FT	SIZE	DIMENSIONS IN INCHES				
					A	B	C	D	E
4436	36" Chest with end handles	Brite	6.70	Mid	36.75	20.25	15.50	–	–
4444	44" Utility Chest with Handles	Brite	9.70	Mid	44.75	20.25	18.50	–	–
4455	55" Low Profile Chest/Slant Bottom	Brite	12.10	Mid/Full	55.75	20.25	18.50	16.50	6.00
74455	55" Low Profile Chest/Slant Bottom	Black	13.50	Mid/Full	55.75	20.25	18.50	16.50	6.00
4460	60" Low Profile Chest/Slant Bottom	Brite	13.20	Full	60.75	20.25	18.50	16.50	6.00
74460	60" Low Profile Chest/Slant Bottom	Black	13.20	Full	60.75	20.25	18.50	16.50	6.00
5548	48" Chest	Brite	11.30	Full	48.75	20.50	19.63	–	–
5560	60" Chest	Brite	14.10	Full	60.75	20.50	19.63	–	–

## Challenger Side Bin Boxes

Each box is built solid with thick, diamond-treaded aluminum walls and lockable steel paddle handles. Side bin provides unobstructed view of the road and truck bed.

- Domed, aerodynamic, foam-filled lid adds strength, reduces drag
- Elongated single lid allows for storage of oversized gear
- Easy to install, no-drill hardware included
- Reinforced mounting brackets mount to side of bed
- Three convenient sizes, works with/without cross bed toolbox

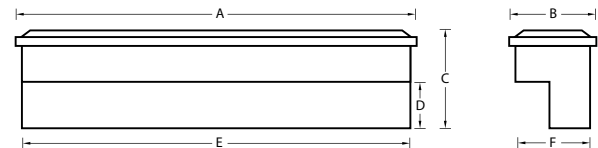
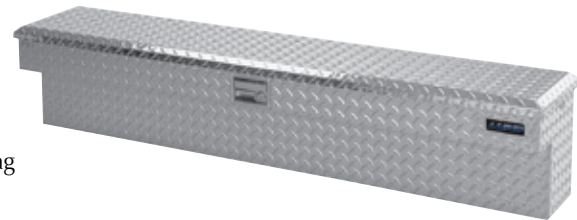

MODEL	DESCRIPTION	STYLE	CUBIC FT	SIZE	DIMENSIONS IN INCHES					
					A	B	C	D	E	F
5748	48" Side Bin Truck Tool Box	Brite	8.80	Full	48.13	12.50	13.00	7.75	47.50	7.63
75748	48" Side Bin Truck Tool Box	Black	8.80	Full	48.13	12.50	13.00	7.75	47.50	7.63
5760	60" Side Bin Truck Tool Box	Brite	11.10	Full	60.13	12.50	13.00	7.75	59.50	7.63
5772	72" Side Bin Truck Tool Box	Brite	12.50	Full	72.13	12.50	13.00	7.75	47.50	7.63



## Challenger Underbed Storage

Use on platform, dump trucks and gooseneck trailer underbody locations to provide valuable storage space.

- Durable, diamond plated aluminum
- Hand-welded seams increase strength
- Stainless steel locking latch with easy grip, T handle
- Weatherproof gasket prevents leakage

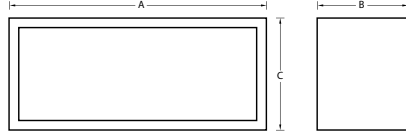

MODEL	DESCRIPTION	STYLE	CUBIC FT	SIZE	DIMENSIONS IN INCHES		
					A	B	C
8224	24" Underbed Storage	Brite	4.50	Small	24.00	18.00	18.00
8236	36" Underbed Storage	Brite	6.80	Med	36.00	18.00	18.00

## Topside Storage Boxes

Protect tools and equipment while keeping them conveniently within reach. Keep the cab clear, valuables out of sight in this weather-resistant (weather-tight seal) box.



MODEL	DESCRIPTION	STYLE	CUBIC FT	SIZE	DIMENSIONS IN INCHES		
					A	B	C
8172	72" Topside Box	Brite	8.50	Full	72.00	12.81	16.00
8190	90" Topside Box	Brite	10.70	Full	90.00	12.81	16.00
8196	96" Topside Box	Brite	16.50	Full	96.00	14.81	20.00

## Trailer Utility Boxes

Designed to maximize valuable space between your trailer and hitch, this utility box stores and protects tools and equipment.

- Single-hinge design and weather-tight seal
- Secure stainless steel locking latch with wide 3-finger latch handles
- Convenient single-handed entry



MODEL	DESCRIPTION	STYLE	CUBIC FT	SIZE	DIMENSIONS IN INCHES			
					A	B	C	D
6134	20" Trailer Utility Box	Brite	4.10	Med	34.50	14.88	15.25	20.75
6149	34" Trailer Utility Box	Brite	5.10	Large	48.88	16.88	18.25	34.25

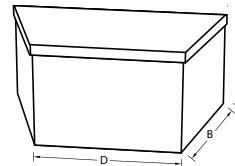

## Challenger Hand-Tote Storage Boxes

Made out of high-grade, rust-resistant aluminum featuring a diamond plate finish. Rugged, roomy storage boxes secure valuables and can't be beat for their portability and durability.



MODEL	DESCRIPTION	STYLE	CUBIC FT	SIZE	DIMENSIONS IN INCHES		
					A	B	C
5116	16" Domed-lid Hand-Tote	Brite	0.70	Med	16.50	8.50	8.25
5124	24" Domed-lid Hand-Tote	Brite	1.20	Large	24.25	10.25	8.50

## ATV Storage Boxes

Front or rear rack boxes, conveniently and solidly lock onto ATV rack without obstructing view and allow for a comfortable ride. Multi-purpose use boxes secure storage on your ATV, in the bed of your truck, or as a heavy-duty storage system in your garage or workshop.

- Fits most ATV vehicles
- Heavy-duty gas shock
- Secure and easy grip, 3-finger locking paddle handle

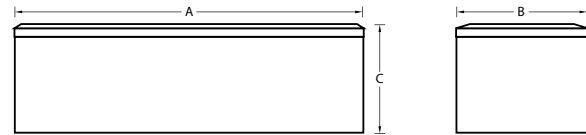

BRITE	BLACK	DESCRIPTION	CUBIC FT	SIZE	DIMENSIONS IN INCHES		
					A	B	C
-	288271	32" ATV Rear Storage Box	3.70	Full	32.00	14.00	14.25
-	288272	32" Front ATV Storage Box	1.50	Slim	32.00	12.75	6.50
288271A	288271BK	32" Rear ATV Box	3.70	Slim	32.00	12.00	13.50
288273A	288273BK	36" ATV Storage Box	5.60	Full	36.75	19.50	13.50



## LUND CBT Storage System

This is the ultimate work truck storage solution featuring two heavy-duty, lockable contractor grade boxes with an integrated tonneau cover and over 11 cu. ft. of usable space.

- Lockable, quick-release stainless box handles
- Single-lid design, stores oversized (long) items
- Solid diamond plate hinged tonneau cover
- Tonneau cover supported by two gas shocks for easy access
- Lockable tonneau latch secures truck bed

YEAR	MAKE	MODEL	TYPE	CBT SYSTEM TONNEAU + 2 BOXES	CBT TONNEAU ONLY	CBT SIDE BOX ONLY (1 PIECE)
<b>CHEVROLET</b>						
1999-2014	CHEVROLET	SILVERADO	6' BED	597107	97107	288379
1999-2014	CHEVROLET	SILVERADO	8' BED	597109	97109	288396
1999-2014	CHEVROLET	SILVERADO	5.5' BED	597103	97103	288369
<b>DODGE</b>						
2003-2014	DODGE	RAM ALL	5.7' BED	597105	97105	288367
2003-2014	DODGE	RAM ALL	6.5' BED	597104	97104	288376
2002-2014	DODGE	RAM ALL	8' BED	597109	97109	288396
<b>FORD</b>						
2004-2014	FORD	F-150	5.5' BED	597105	97105	288367
2004-2014	FORD	F-150	6.5' BED	597107	97107	288379
2004-2014	FORD	F-150	8' BED	597109	97109	288396
1999-2014	FORD	SUPER DUTY	6.7' BED	597108	97108	288382
1999-2014	FORD	SUPER DUTY	8' BED	597109	97109	288396
<b>GMC</b>						
1999-2014	GMC	SIERRA	6' BED	597107	97107	288379
1999-2014	GMC	SIERRA	8' BED	597109	97109	288396
1999-2014	GMC	SIERRA	5.5' BED	597103	97103	288369
<b>TOYOTA</b>						
2006-2014	TOYOTA	TUNDRA	8' BED	597109	97109	288396
2006-2014	TOYOTA	TUNDRA	6.5' BED	597104	97104	288376

## Ultima Premium Aluminum Storage Boxes

Thick diamond plate aluminum construction with reinforced weather-tight, dome style lid, full-length piano style hinge and adjustable lid stickers.

- Easy access with self-rising lid
- Deep molded tool tray provides storage for small items and sits above the ledge
- Quick release, lockable stainless paddle handles
- Built in tool holder



## Ultima Cross Bed Boxes

MODEL	DESCRIPTION	STYLE	CUBIC FT	SIZE	DIMENSIONS IN INCHES						
					A	B	C	D	E	F	G
9100	70" Cross Bed Box	Brite	11.60	Full	70.13	20.50	14.00	8.75	61.50	18.00	-
9100DB	70" Deep Cross Bed Box	Brite	14.80	Full/Deep	70.13	20.50	17.75	12.38	61.50	18.00	-
9100LP	70" Low Profile Cross Bed Box	Brite	9.66	Full	70.13	20.50	14.00	10.75	61.50	18.00	-
79100	70" Cross Bed Box	Black	11.60	Full	70.13	20.50	14.00	8.75	61.50	18.00	-
79100DB	61" Cross Bed Single Lid	Black	8.80	Full/Deep Well	61.00	20.50	18.00	20.50	5.50	4.25	12.50
9200	60" Cross Bed Box	Brite	7.80	Mid	60.25	20.50	14.00	8.75	51.50	18.00	-
9300*	64" Cross Bed Box	Brite	10.60	Mid	63.25	20.50	14.00	8.75	54.50	18.00	-

\* Will NOT fit '08 Dakota with cargo rail system, Chevy Colorado, GMC canyon Crew Cab  
Toyota Tacoma Extended and Crew Cab will need part #954102

## Ultima Low Profile Chest

MODEL	DESCRIPTION	STYLE	CUBIC FT	SIZE	DIMENSIONS IN INCHES				
					A	B	C	D	E
9460	60" Low Profile Chest, Slant Bottom	Brite	13.10	Full	60.75	20.13	18.50	16.50	6.00
9201LP	60" Low Profile Cross Bed Box	Brite	10.20	Full	60.25	20.13	14.50	16.50	6.00

## Ultima Gull-Wing Cross Bed Boxes

Hardworking and reliable, this three-piece box features thick diamond plate aluminum construction with fully welded seams and a reinforced weather-tight, dome style lid.

- Quick-release, lockable stainless-steel paddle handles (prevents moisture from entering the box)
- Deep-molded tool tray sits above the ledge providing storage for small items
- Includes mounting hardware (light drilling required)
- Brite aluminum or black powder coated finishes

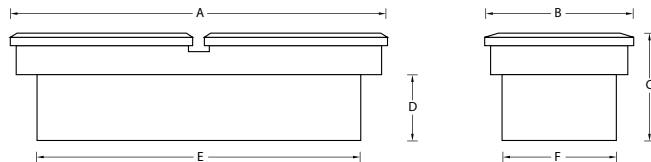

MODEL	DESCRIPTION	STYLE	CUBIC FT	SIZE	DIMENSIONS IN INCHES					
					A	B	C	D	E	F
9150	70" Gull-Wing Cross Bed Box	Brite	11.60	Full	70.13	20.50	14.00	8.75	61.50	18.00
79150	70" Gull-Wing Cross Bed Box	Black	11.60	Full/Deep	70.13	20.50	14.00	8.75	61.50	18.00
9250	60" Gull-Wing Cross Bed Box	Brite	7.80	Full	60.13	20.50	14.00	8.75	51.50	18.00
9352*	64" Gull-Wing Cross Bed Box	Brite	8.80	Full	63.13	20.50	14.00	8.75	54.50	18.00

\* Will NOT fit '08 Dakota with cargo rail system, Chevy Colorado, GMC canyon Crew Cab  
Toyota Tacoma Extended and Crew Cab will need part #954102



## Contender Cross Bed Boxes

Constructed with heavy-duty diamond plate aluminum and fully welded seams, this three-piece box is the perfect every day truck box. Reinforced dome style lid with weatherproof seal, piano hinge and adjustable strikers protects contents from theft and weather damage.

- Easy access with self-rising lid
- Quick release, weather-proof locking handles
- Includes mounting hardware (light drilling required)

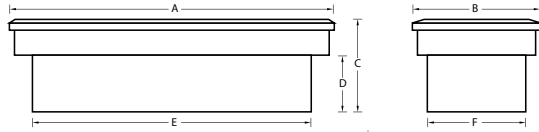

BLACK MODEL	BRITE MODEL	DESCRIPTION	CUBIC FT	SIZE	DIMENSIONS IN INCHES					
					A	B	C	D	E	F
7511100	111001	70" Cross Bed Box	11.50	Full	70.50	17.38	12.38	8.00	61.63	16.75
7511200	111002	60" Cross Bed Box	8.80	Mid	60.50	17.38	12.38	8.00	51.63	16.75

## Storage Box Accessories & Replacement Parts

PART #	DESCRIPTION
954100	Single pack mounting kit
954102	Auxiliary mounting kit for '05 Toyota Tacoma Extended & Crew Cab
3-4200-SS	Stainless steel non locking rectangular latch
3-4201-SSK	Stainless steel locking rectangular latch
P-0283	Replacement T-Handle for underbody boxes
P3-4200	Zinc plated non-locking rectangular latch
P3-4201K	Zinc plated locking rectangular latch

PART #	DESCRIPTION
Call for P/N	Replacement gas shocks for toolboxes
Call for P/N	Replacement keys for Seal-Tite boxes
Call for P/N	Replacement keys for Challenger, Ultima or Contender Boxes
Call for P/N	Replacement pushbuttons for Seal-Tite boxes
Call for P/N	Replacement lock cylinders for paddle latches



## Tool Box Accessories



PART #	DESCRIPTION
<b>SEAL-TITE</b>	
5121-9R	Seal-Tite 20" and Side Mounts (Aluminum – for boxes after 9/17/99)
5121-10R	Seal-Tite 26" Cross Bed (Aluminum – for boxes after 9/17/99)
5121-11R	Seal-Tite 07500 RV Chest (Aluminum – for boxes after 9/17/99)
5121-17R	Black Plastic Tray for Side Mounts (inc. diamond)
5121-18R	Black Plastic Tray for Cross Bed (inc. diamond)
<b>CHALLENGER</b>	
5121-17R	Black Plastic Tray for Side Mounts
5121-18R	Black Plastic Tray for Cross Bed
<b>ULTIMA</b>	
5121-17R	Black Plastic Tray for Cross Bed
<b>CBT</b>	
28840	CBT 4-Bin Storage Kit
288401	CBT 5-Bin Storage Kit
288402	CBT Divider Kit

## Aluminum Standard LUND Boxes

### Aluminum Box Overview Features:

- 90° lid opening is included on all aluminum and steel cross beds
- Side pockets are included on all Cross Beds except low profile models

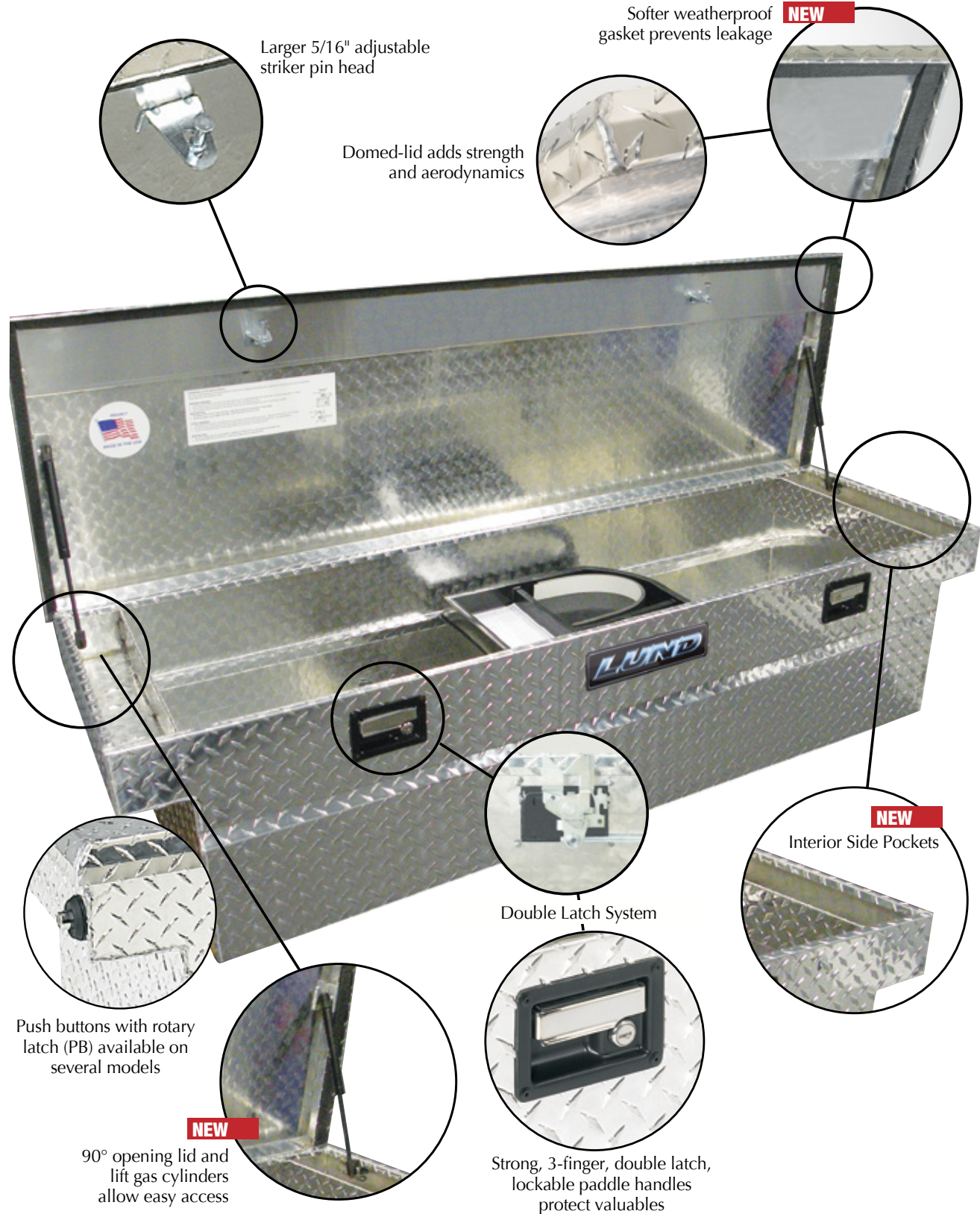

## Standard Cross Bed Boxes

Designed to fit most full-size trucks, these boxes maximize storage space while providing access to additional storage underneath the box. Premium features include interior side pockets, a 4-section sliding tool tray and secure commercial grade locking latches. Available in brite aluminum or black powder coat finishes.

- Single-lid design allows storage of larger equipment
- Heavy-duty diamond plate
- Hand-welded by expert craftsman
- Easy grip, 3-finger paddle handles for single-hand entry
- Commercial-grade steel locking latch securely riveted to box
- Encased locking arm system protects box contents during use
- Weatherproof gasket seals tight to prevent leakage

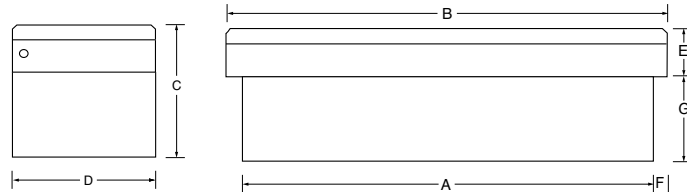

BRITE	BLACK	DESCRIPTION	CUBIC FT	SIZE	DIMENSIONS IN INCHES						
					A	B	C	D	E	F	G
9301	79301	59" Cross Bed	7.20	Mid	47.75	58.75	12.75	20.50	4.75	5.50	8.00
9300T	79310	63" Cross Bed	8.20	Mid	54.50	63.75	12.75	20.50	4.75	4.25	8.00
9303	79303	68" Cross Bed	8.80	Mid	58.50	67.75	12.75	20.50	4.75	4.25	8.00
9303PB	79303PB	68" Cross Bed, Push Button	8.80	Mid	58.50	67.75	12.75	20.50	4.75	4.25	8.00
9210	79210	60" Cross Bed	7.80	Mid	51.50	60.75	12.75	20.50	5.00	4.25	7.75
9200PB	79200PB	60" Cross Bed, Push Button	7.80	Mid	51.50	60.75	12.75	20.50	5.00	4.25	7.75
9202DBT	79202DB	60" Cross Bed, Deep Well	9.5	Mid	51.50	60.75	15.50	20.50	5.50	4.25	10.00
9202DBPB	79202DBPB	60" Cross Bed, Deep Well, Push Button	9.5	Full	51.50	70.25	15.50	20.50	5.50	4.25	10.00
511100	7511100	70" Cross Bed Slimline	8.80	Full	61.00	70.00	12.38	16.00	5.50	4.25	11.00
9100T	79100T	70" Cross Bed Box	9.66	Full	61.00	70.25	15.50	20.50	5.50	4.25	10.00
9100PB	79100PB	70" Cross Bed Box, Push Button	9.66	Full	61.00	70.25	15.50	20.50	5.50	4.25	10.00
9306	79306	70" Cross Bed 28" Wide	13.40	Full	63.00	72.25	18.00	28.30	5.50	4.25	12.50
9306PB	79306PB	70" Cross Bed 28" Wide, Push Button	14.00	Full	61.00	70.25	14.00	28.30	5.50	4.25	8.50
9100DBT	79100DB	71" Cross Bed, Deep Well	11.46	Full/Deep	61.00	70.25	18.00	20.50	5.50	4.25	12.50
9100DBPB	79100DBPB	71" Cross Bed, Deep Well, Push Button	11.46	Full/Deep	61.00	70.25	18.00	20.50	5.50	4.25	12.50
9305	79305	72" Cross Bed HD	11.60	Full	63.00	72.25	15.50	20.50	5.50	4.25	10.00
9305DB	79305DB	72" Cross Bed HD, Deep Well	13.50	Full	63.00	72.25	18.00	20.50	5.50	4.25	12.50
9305PB	79305PB	72" Cross Bed HD, Push Button	11.50	Full	63.00	72.25	15.50	20.50	5.50	4.25	10.00
9305DBPB	79305DBPB	72" Cross Bed HD, Deep Well, Push Button	13.50	Full	63.00	72.25	18.00	20.50	5.50	4.25	12.50
9307	79307	72" Cross Bed 28" Wide	14.00	Full	61.00	70.25	14.00	28.30	5.50	4.25	8.50
9307PB	79307PB	72" Cross Bed 28" Wide, Push Button	14.00	Full	61.00	70.25	14.00	28.30	5.50	4.25	8.50





### Low Profile Cross Bed Boxes

Provides maximum rear window visibility and features aerodynamic styling to complement the truck design.

- Domed, aerodynamic, foam-filled lid adds strength, reduces drag
- Maintains ample bed access under box
- Easy grip, 3-finger paddle handles for single-hand entry
- Single lid design allows for easy storage of larger items



9305LP

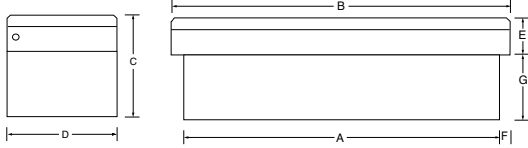

DIMENSIONS IN INCHES												
MODEL	DESCRIPTION	STYLE	CUBIC FT	SIZE	A	B	C	D	E	F	G	
79200LP	60" Cross Bed, Low Profile, Single Lid	Black	6.70	Full	51.50	60.75	11.00	20.50	3.50	4.25	7.50	
9210LP	60" Cross Bed, Low Profile, Single Lid	Brite	6.70	Full	51.50	60.75	11.00	20.50	3.50	4.25	7.50	
79304	62" Cross Bed, Low Profile, Push Button, Single Lid	Black	7.00	Mid	38.00	62.38	15.25	21.00	3.75	4.5	11.75	
791000LP	70" Cross Bed, Low Profile, Single Lid	Black	9.40	Full	61.00	70.25	13.00	20.50	3.50	4.25	9.50	
9100LPT	70" Cross Bed, Low Profile, Single Lid	Brite	9.40	Full	61.00	70.25	13.00	20.50	3.50	4.25	9.50	
79100LP	70" Cross Bed, Low Profile, Single Lid	Black	9.40	Full	61.00	70.25	13.00	20.50	3.50	4.25	9.50	
9305LP	72" HD Cross Bed, Low Profile, Single Lid	Brite	9.00	Full	63.00	72.25	12.00	20.50	3.50	4.25	8.50	
79305LP	72" HD Cross Bed, Low Profile, Single Lid	Black	9.00	Full	63.00	72.25	12.00	20.50	3.50	4.25	8.05	

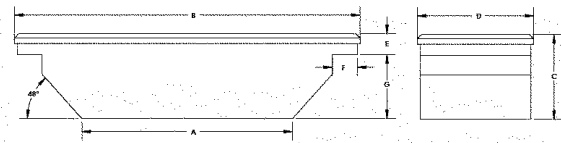

9304



DIMENSIONS IN INCHES													
MODEL	DESCRIPTION	STYLE	CUBIC FT	SIZE	A	B	C	D	E	F	G	H	
9304	63" Cross Bed, Beveled Bottom, Low Profile, Single Lid	Brite	7.00	Mid	38.00	62.38	15.25	21.00	3.75	4.50	11.75	11.75	

\*Fits most mid-size trucks including: Ford Ranger, Nissan Frontier, Chevy S-10, Colorado, Mazda, GMC S-15 and Toyota Tacoma

### Gull-Wing Cross Bed Boxes

Twin lids, each self-rising, offer easy, single-handed access to worksite equipment. Storage space is maximized with access to additional storage underneath the box. Each box offers premium features at an affordable price.

- Larger 5/16" adjustable striker pin head
- Easy access self-rising lid for easy single-hand usage



79353DB

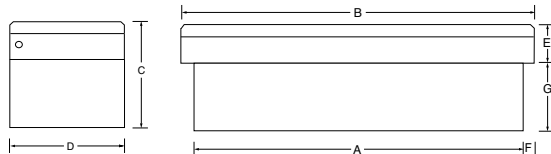

Push buttons with rotary latch (PB) available on several models



DIMENSIONS IN INCHES												
BRITE MODEL	BLACK MODEL	DESCRIPTION	CUBIC FT	SIZE	A	B	C	D	E	F	G	
9352T	79350	63" Cross Bed, Gull-Wing	9.10	Mid	54.50	63.75	14.00	20.50	5.50	4.25	8.50	
9353DB	79353DB	67" Cross Bed, Gull-Wing, Deep Well,	9.70	Mid/Deep	58.50	67.75	14.00	20.50	5.50	4.25	8.50	
9250T	79251	60" Cross Bed Gull-Wing	9.60	Mid	51.50	60.75	14.00	20.50	5.50	4.25	8.50	
9250DB	79250DB	60" Cross Bed, Gull-Wing, Deep Well	10.70	Mid/Deep	51.50	60.75	15.00	20.50	5.50	4.25	10.50	
9250PB	79250PB	60" Cross Bed, Gull-Wing, Push Button	9.60	Mid	51.50	60.75	14.00	20.50	5.50	4.25	8.50	
9150T	79150T	70" Cross Bed, Gull-Wing	9.40	Full	61.00	70.25	13.00	20.50	5.50	4.25	9.50	
9150PB	79150PB	70" Cross Bed, Gull-Wing, Push Button	9.40	Full	61.00	70.25	13.00	20.50	5.50	4.25	9.50	
9154	79154	72" HD Cross Bed, Gull-Wing	9.00	Full	63.00	70.25	12.00	20.50	5.50	4.25	8.50	
9350PB	79350PB	72" HD Cross Bed, Gull-Wing, Push Button	9.00	Full	63.00	70.25	12.00	20.50	5.50	4.25	8.50	

## ECL Series Aluminum Truck Boxes

Built for everyday use, these boxes keep equipment safe and dry with a reinforced dome lid and seal-tight, weatherproof gasket, adjustable strikers, and heavy-duty aluminum piano-style hinge for extra strength and durability.

- Heavy-duty, diamond plate aluminum construction
- Abrasion and corrosion-resistant finish
- Self-rising lid provides a full 90° opening
- Quick release, weatherproof zinc locking handles



111002T

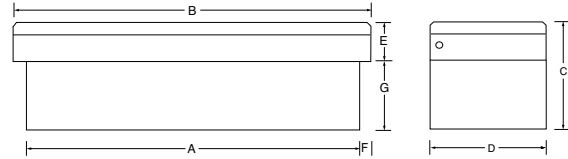

### ECL Cross Bed Boxes

MODEL	DESCRIPTION	STYLE	CUBIC FT	SIZE	DIMENSIONS IN INCHES						
					A	B	C	D	E	F	G
111002T	60" Cross Bed, 16" Wide	Brite	6.20	Mid	51.50	60.75	13.00	16.00	5.50	4.25	7.50
7111002T	60" Cross Bed, 16" Wide	Black	6.20	Mid	51.50	60.75	13.00	16.00	5.50	4.25	7.50
111002LP	60" Cross Bed, Low Profile, 16" Wide	Brite	5.20	Mid	51.50	60.75	11.00	16.00	3.50	4.25	7.50
7111002LP	60" Cross Bed, Low Profile, 16" Wide	Black	5.20	Mid	51.50	60.75	11.00	16.00	3.50	4.25	7.50
111001T	70" Cross Bed, 16" Wide	Brite	7.30	Full	61.00	70.25	13.00	16.00	5.50	4.25	7.50
7111000	70" Cross Bed, 16" Wide	Black	7.30	Full	61.00	70.25	13.00	16.00	5.50	4.25	7.50
111001LP	70" Cross Bed, Low Profile, 16" Wide	Brite	6.20	Full	61.00	70.25	11.00	16.00	3.50	4.25	7.50
7111001LP	70" Cross Bed, Low Profile, 16" Wide	Black	6.20	Full	61.00	70.25	11.00	16.00	3.50	4.25	7.50

### ECL Gull-Wing Cross Bed Boxes

MODEL	DESCRIPTION	STYLE	CUBIC FT	SIZE	DIMENSIONS IN INCHES						
					A	B	C	D	E	F	G
111052	60" Cross Bed, Gull-Wing Aluminum, 16" Wide	Brite	6.20	Mid	51.50	60.75	13.00	16.00	5.50	4.25	7.50
7111052	60" Cross Bed, Gull-Wing Aluminum, 16" Wide	Black	6.20	Mid	51.50	60.75	13.00	16.00	5.50	4.25	7.50
111051	70" Cross Bed, Low Profile, Gull Wing, 16" Wide	Brite	7.30	Full	61.00	70.25	13.00	16.00	5.50	4.25	7.50
7111051	70" Cross Bed, Low Profile, Gull Wing, 16" Wide	Black	7.30	Full	61.00	70.25	13.00	16.00	5.50	4.25	7.50





### Flush Mount Side Boxes

Flush mount boxes provide an unobstructed view and full use of the truck bed.

- Strong, locking T-handles protect valuables
- Aerodynamic styling complements truck designs
- Doubles as a utility box or storage locker for SUVs

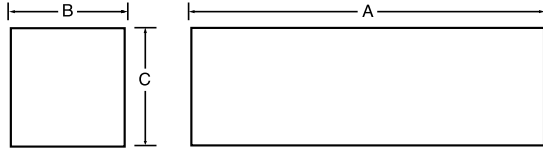

4460FM

MODEL	DESCRIPTION	STYLE	CUBIC FT	SIZE	DIMENSIONS IN INCHES		
					A	B	C
4448FM	48" Flush Mount Box	Brite	3.70	Mid	48.50	12.50	10.50
74448FM	48" Flush Mount Box	Black	3.70	Mid	48.50	12.50	10.50
4460FM	60" Flush Mount Box	Brite	4.60	Full	60.50	12.50	10.50
74460FM	60" Flush Mount Box	Black	4.60	Full	60.50	12.50	10.50
4470FM	70" Flush Mount Box	Brite	5.40	Full	70.50	12.50	10.50
74470FM	70" Flush Mount	Black	5.40	Full	70.50	12.50	10.50



4460FM

### Side Bin Boxes

Side bin boxes provide extra room needed for efficient tool and equipment truck bed storage.

- Sturdy paddle handle or push button opening
- Keyed locks protect valuables
- Heavy-duty gas shocks provide smooth lid opening
- Fits full or mid-size trucks
- Brite aluminum or black powder coat finishes

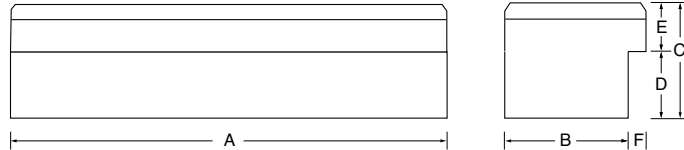

9748PB

MODEL	DESCRIPTION	STYLE	CUBIC FT	SIZE	DIMENSIONS IN INCHES					
					A	B	C	D	E	F
9748PB	48" Side Bin Box push button	Brite	4.20	Mid/Full	48.00	8.00	12.50	6.00	6.50	4.50
9748	48" Side Bin Box 3 finger latch	Brite	4.20	Mid/Full	48.00	8.00	12.50	6.00	6.50	4.50
79748PB	48" Side Bin Box push button	Black	4.20	Mid/Full	48.00	8.00	12.50	6.00	6.50	4.50
79748	48" Side Bin Box 3 finger latch	Black	4.20	Mid/Full	48.00	8.00	12.50	6.00	6.50	4.50
9760PB	60" Side Bin Box push button	Brite	6.20	Full	60.00	8.00	14.00	8.00	6.00	4.50
9760	60" Side Bin Box 3 finger latch	Brite	6.20	Full	60.00	8.00	14.00	8.00	6.00	4.50
79760PB	60" Side Bin Box push button	Black	6.20	Full	60.00	8.00	14.00	8.00	6.00	4.50
79760	60" Side Bin Box 3 finger latch	Black	6.20	Full	60.00	8.00	14.00	8.00	6.00	4.50
9772PB	70" Side Bin Box push button	Brite	7.30	Full	70.00	8.00	14.00	8.00	6.00	4.50
9772	70" Side Bin Box 3 finger latch	Brite	7.30	Full	70.00	8.00	14.00	8.00	6.00	4.50
79772PB	70" Side Bin Box push button	Black	7.30	Full	70.00	8.00	14.00	8.00	6.00	4.50
79772	70" Side Bin Box 3 finger latch	Black	7.30	Full	70.00	8.00	14.00	8.00	6.00	4.50



9760



79760

### Chest/Flush Mount Boxes

The flush mount design provides a clean look and an unobstructed view. Angled at the bottom of front and side walls to accommodate sloped bed walls and wheel wells. Offset lid construction allows lid to open fully without back wall interference.

- Secure, easy grip, 3-finger paddle handle with stainless steel locking latch
- Fits mid and full-size trucks
- Brite aluminum or black powder coat finishes

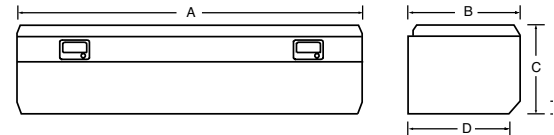

MODEL	DESCRIPTION	STYLE	CUBIC FT	SIZE	DIMENSIONS IN INCHES				
					A	B	C	D	E
9436T	36" Flush Mount Box	Brite	8.10	Mid	36.75	20.50	18.50	-	-
79436	36" Flush Mount Box	Black	8.10	Mid	36.75	20.50	18.50	-	-
9436WB	36" Flush Mount Box	Brite	9.40	Mid/Wide	36.75	24.00	18.50	-	-
79436WB	36" Flush Mount Box	Black	9.40	Mid/Wide	36.75	24.00	18.50	-	-
9447	48" Flush Mount Box	Brite	11.80	Mid	47.75	20.50	18.00	16.00	4.00
79447	48" Flush Mount Box	Black	11.80	Mid	47.75	20.50	18.00	16.00	4.00
9447WB	48" Flush Mount Box	Brite	12.30	Mid/Wide	47.75	24.00	18.50	-	-
79447WB	48" Flush Mount Box	Black	12.30	Mid/Wide	47.75	24.00	18.50	-	-
9456	56" Flush Mount Box	Brite	13.80	Full	56.75	20.50	18.00	16.00	4.00
79456	56" Flush Mount Box	Black	13.80	Full	56.75	20.50	18.00	16.00	4.00
9456WB	56" Flush Mount Box	Brite	14.60	Full/Wide	56.75	24.00	18.50	-	-
79456WB	56" Flush Mount Box	Black	14.60	Full/Wide	56.75	24.00	18.50	-	-
9460CC	60" Flush Mount Box	Brite	14.10	Crew Cab	60.75	20.50	18.50	-	10.50
79460CC	60" Flush Mount Box	Black	14.10	Crew Cab	60.75	20.50	18.50	-	10.50
9460WB	60" Flush Mount Box	Brite	15.60	Full/Wide	60.75	24.00	18.50	-	-
79460WB	60" Flush Mount Box	Black	15.60	Full/Wide	60.75	24.00	18.50	-	-
9460SL	60" Flush Mount Box	Brite	12.00	Full/Slim Line	60.50	18.50	18.50	-	-
79460SL	60" Flush Mount Box	Black	12.00	Full/Slim Line	60.50	18.50	18.50	-	-
9460T	60" Flush Mount	Brite	14.10	Full	60.75	20.50	18.00	16.00	-
79460T	60" Flush Mount	Black	14.10	Full	60.75	20.50	18.00	16.00	-
9460WB	60" Flush Mount Wide	Brite	14.10	Full/Wide	60.75	24.00	18.50	23.00	-
79460WB	60" Flush Mount Wide	Black	14.10	Full/Wide	60.75	24.00	18.50	23.00	-



9436



79447



9460CC



9460SL

### Top Mount Boxes

This double-box design fits most trucks and provides additional storage without compromising valuable truck bed space.

- Hand-welded construction
- Weatherproof gaskets protect contents from the elements
- Front opening for easy access and visibility
- Locking stainless steel flush mount T-handle provides security
- Larger sizes have two compartments for easy access

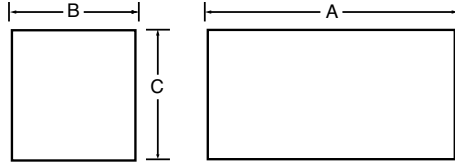

MODEL	DESCRIPTION	STYLE	CUBIC FT	SIZE	DIMENSIONS IN INCHES		
					A	B	C
8148	48" Top Mount Box	Brite	5.70	Full	48.00	12.75	16.00
8160	60" Top Mount Box	Brite	7.10	Full	60.00	12.75	16.00
8172T	72" Top Mount Box	Brite	8.50	Full	72.00	12.75	16.00
8190T	90" Top Mount Box	Brite	10.60	Full	90.00	12.75	16.00
8196T	96" Top Mount Box	Brite	11.30	Full	96.00	12.75	16.00

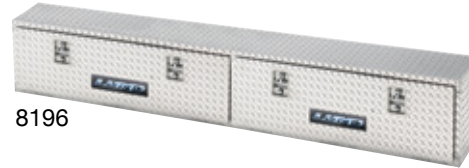

### Rail Top Mount Boxes

This double-box design is easily mounted to the bed rails providing additional storage without compromising valuable truck bed space.

- Locking stainless steel flush mount T-handle provides security
- Weatherproof gaskets protect contents from the elements
- Larger sizes have four compartments
- Diamond-tread, brite aluminum finish

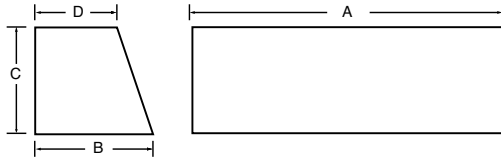

MODEL	DESCRIPTION	STYLE	CUBIC FT	SIZE	DIMENSIONS IN INCHES			
					A	B	C	D
8272	72" Professional Rail Top Box	Brite	10.70	Full	72.00	12.00	22.50	9.00
8290	90" Professional Rail Top Box	Brite	13.50	Full	90.00	12.00	22.50	9.00
8296	96" Professional Rail Top Box	Brite	14.60	Full	96.00	12.00	22.50	9.00





### Aluminum Fender Well Boxes

These fender well boxes provide the extra room you need for effective storage solutions on either side of your truck bed.

- Strong, lockable T-handle protects valuables
- Weatherproof gaskets protect contents from the elements
- Universal lid design
- Available in several sizes: 48" and 60"
- Diamond-tread, brite aluminum finish

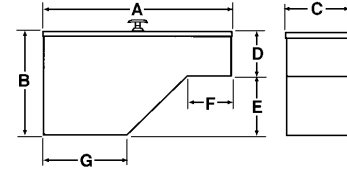

DIMENSIONS IN INCHES											
MODEL	DESCRIPTION	STYLE	CUBIC FT	SIZE	A	B	C	D	E	F	G
8225	48" Fender Well Box	Brite	3.10	Full	48.50	20.50	8.50	8.50	12.00	21.00	16.25
78225	48" Fender Well Box	Black	3.10	Full	48.50	20.50	8.50	8.50	12.00	21.00	16.25
8226	60" Fender Well Box	Brite	3.50	Full	60.50	20.50	8.50	8.50	12.00	33.00	16.25
78226	60" Fender Well Box	Black	3.50	Full	60.50	20.50	8.50	8.50	12.00	33.00	16.25

### Fender Well Gun Boxes

Keep guns and equipment safe and secure within this heavy-duty diamond plated aluminum gun box. Rust-resistant and weatherproof with stainless steel latches for added security.

- Two storage compartments
- Felt shelf protects shotguns
- Easy access from the back of truck bed
- Ample space for storage of ammunition and accessories
- Strong, lockable T-handle protects valuables
- Available in several sizes: 54" and 60"
- Brite aluminum or black powder coat finish

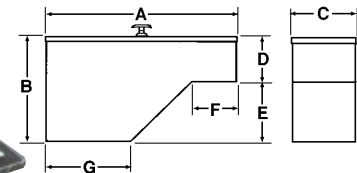
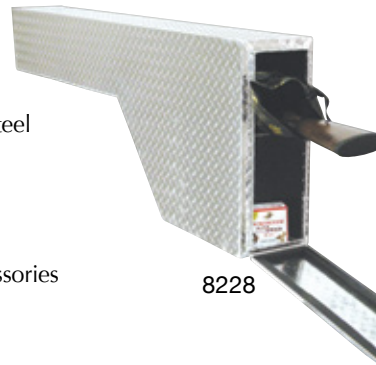

DIMENSIONS IN INCHES											
MODEL	DESCRIPTION	STYLE	CUBIC FT	SIZE	A	B	C	D	E	F	G
8227	53" Fender Well Gun Box	Brite	3.30	Full	54.00	20.50	8.50	8.50	12.00	26.00	16.25
78227	53" Fender Well Gun Box	Black	3.30	Full	54.00	20.50	8.50	8.50	12.00	26.00	16.25
8228	60" Fender Well Gun Box	Brite	3.50	Full	60.50	20.50	8.50	8.50	12.00	33.00	16.25
78228	60" Fender Well Gun Box	Black	3.50	Full	60.50	20.50	8.50	8.50	12.00	33.00	16.25

### 5th Wheel Box

Utilize previously inaccessible space with our three tiered boxes featuring locking lids at all three levels. Convenient storage for tools, equipment, and other expensive tools.

- Constructed of durable aluminum tread plate
- Easy grip, 3-finger locking paddle handles
- Double latch system for added security
- Mounts to floor of pickup or flatbed

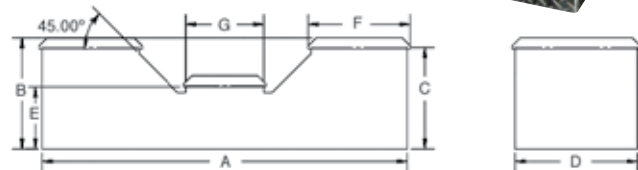

DIMENSIONS IN INCHES											
BRITE	BLACK	DESCRIPTION	CUBIC FT	SIZE	A	B	C	D	E	F	G
6132	76132	5th Wheel Aluminum Box	11.20	Full	57.00	17.25	15.75	19.00	9.63	16.00	12.13

## Aluminum Cross Bed Dog Boxes

Heavy-duty aluminum dog boxes are designed to keep pets safe, comfortable and secure. Generous air vents provide a well-ventilated, comfortable shelter. Extra compartment stores guns, ammo, and other gear. Available in aluminum cross bed or chest style dog boxes.

- Designed to fit most full-size light duty trucks
- Rust, corrosion-resistant finish
- Features sturdy locking paddle handles
- Foam filled inter-compartment to protect shotguns



## Chest Dog Boxes

Heavy-duty diamond plated aluminum is durable and portable, light enough to hand carry. Versatile carry handles double as tie downs during transit.

- Available in 36"X48" up to 48"X48"
- Designed to fit most pickups
- Rust, corrosion-resistant finish
- Features sturdy locking T-handles
- Divider included on both units
- Air vents keep box interior well ventilated
- Ideal for sportsmen and hunters



4406

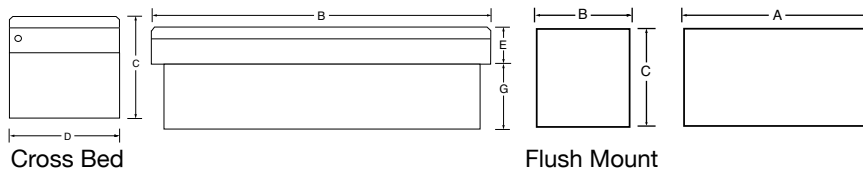

MODEL	DESCRIPTION	STYLE	CUBIC FT	SIZE	DIMENSIONS IN INCHES						
					A	B	C	D	E	F	G
4404	Cross Bed Dog Box	Brite	18.30	Full	61.00	70.25	24.50	20.50	5.50	4.25	19.00
4406	36" Flush Mount Dog Box	Brite	24.00	Full	36.00	24.00	48.00	-	-	-	-
4418	48" Flush Mount Dog Box	Brite	32.00	Full	48.00	24.00	48.00	-	-	-	-

## Heavy-Duty Coolers

Built-in insulated liner keeps contents cold, while adding enough box wall strength to double as extra seating. Attractive brite aluminum finish also helps reflect sunlight, keeping contents cooler longer.

- Two sizes: 48 quart/12 gallon or 24 quart/6 gallon capacities
- Constructed with heavy-duty .060 aluminum for strength and durability
- Ideal for camping, construction sites, and sporting events
- Rust, corrosion-resistant finish
- Sturdy lockable latch



4400

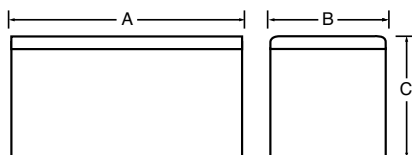

MODEL	DESCRIPTION	STYLE	CUBIC FT	SIZE	DIMENSIONS IN INCHES		
					A	B	C
4400	Heavy-Duty Aluminum Cooler, 48 Qt	Brite	2.20	Mid	24.00	12.00	13.00
4416	Small Aluminum Cooler, 20 QT	Brite	0.90	Full	14.00	10.50	10.75



### Tower Box

Utilizing often over looked space in front of or behind wheel wells, these boxes are a perfect fit to secure small to medium sized tools and equipment. Available in brite aluminum finish.

- Easy grip, 3-finger locking latch paddle handle for security
- Fits in front of or behind wheel well
- Ideal for camping, construction sites, and sporting events
- Rust, corrosion-resistant finish

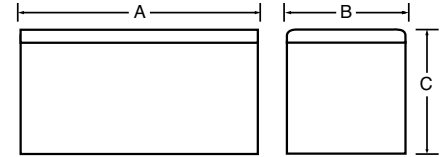

MODEL	DESCRIPTION	STYLE	CUBIC FT	SIZE	DIMENSIONS IN INCHES		
					A	B	C
4417	Aluminum Tower Tool Box	Brite	1.60	Full	19.00	8.00	18.00

### Utility Vehicle Boxes

This rugged cargo box fits the smaller beds on utility vehicles perfectly and contain two removable racks.

- Secure locking, push button releases provide easy single-handed entry
- Weather-tight foam gasket keeps moisture, dirt, and debris out
- Brite aluminum or black powder coat finish

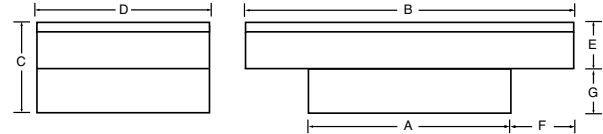

MODEL	DESCRIPTION	STYLE	CUBIC FT	SIZE	DIMENSIONS IN INCHES						
					A	B	C	D	E	F	G
6135	Utility Vehicle Tool Box, Aluminum	Brite	5.60	Mid	40.25	57.75	18.75	10.50	9.75	8.50	9.00
76135T	Utility Vehicle Tool Box, Aluminum	Black	5.60	Full	40.25	57.75	18.75	10.50	9.75	8.50	9.00

### Hand-Held Toolboxes

Heavy-duty diamond plated aluminum box with riveted handle is designed to easily carry more than 100 lbs. Boxes include a removable tray to organize small parts, drill bits, and other hardware.

- Available with one or two clasps for locking
- 24" and 30" hand held toolbox
- Push button design for easy access

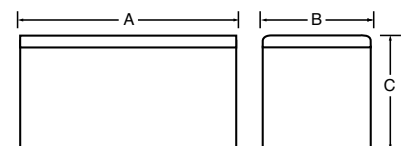

MODEL	DESCRIPTION	STYLE	CUBIC FT	SIZE	DIMENSIONS IN INCHES		
					A	B	C
5124T	24" Hand-Held Tool Box, Aluminum	Brite	1.20	Mid	24.00	9.75	9.00
5140	30" Hand-Held Tool Box, Aluminum	Brite	2.40	Mid	30.00	12.00	11.50

## Underbody Boxes

Underbody Boxes provide a secure, convenient storage solution keeping contents clean and moisture free. (Shelf sold separately.)

- Specially designed channel and bulb seal designed to keep water out
- Thick, coated steel cable allows door to remain open at a 90° angle
- Locking stainless steel flush mount T-handle provides security
- Brite aluminum or black powder coat finish

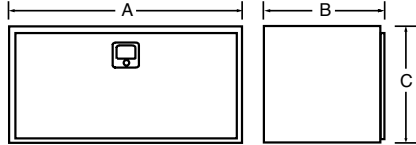

8224T

MODEL	DESCRIPTION	STYLE	CUBIC FT	SIZE	DIMENSIONS IN INCHES		
					A	B	C
8224T	24" Underbody Box	Brite	4.70	Compact	24.00	18.75	18.00
78224	24" Underbody Box	Black	4.70	Compact	24.00	18.75	18.00
8236T	36" Underbody Box	Brite	7.00	Mid	36.00	18.75	18.00
78236	36" Underbody Box	Black	7.00	Mid	36.00	18.75	18.00
8248T	48" Underbody Box	Brite	9.40	Full	48.00	18.75	18.00
78248	48" Underbody Box	Black	9.40	Full	48.00	18.75	18.00
8260T	60" Underbody Box	Brite	11.70	Full	60.00	18.75	18.00
78260	60" Underbody Box	Black	11.70	Full	60.00	18.75	18.00

## Adjustable Shelf Inserts

Organize tools and equipment with one or two sturdy shelves designed to fit LUND's Underbody Boxes.

- Available for 24", 36" and 48" underbodies
- Adjusts to one of three positions
- Constructed of sturdy 16-gauge galvanized steel
- Assembles in less than 10 minutes
- Fits most underbody boxes in the market

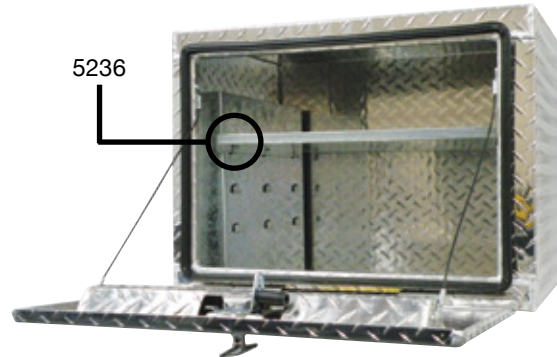

5236

MODEL	DESCRIPTION	STYLE	CUBIC FT	SIZE	DIMENSIONS IN INCHES		
					A	B	C
5224	24" Adjustable Underbody Tray	Brite	0.60	Full	19.00	15.13	3.50
5236	36" Adjustable Underbody Tray	Brite	0.90	Full	31.00	15.13	3.50
5248	48" Adjustable Underbody Tray	Brite	1.30	Full	43.00	15.13	3.50

## Commercial Trucking Underbody and In-Frame Boxes

Heavy-duty aluminum boxes can be mounted as a traditional Underbody Box or secured topside to the trailer frame or deck. Oversized locking (stainless steel) flush mount T-handles provide the ultimate in security.

- Single and double door designs
- Weatherproof gasket seals box to protect content
- Heavy-coated, steel cables allow the door to remain open at 90° angle
- Rust and corrosion resistant heavy-duty diamond plated tread construction



8263

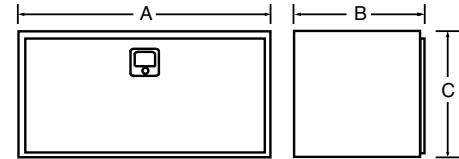

MODEL	DESCRIPTION	STYLE	CUBIC FT	SIZE	DIMENSIONS IN INCHES		
					A	B	C
8261	Industrial Size UB, 36" x 24"	Brite	9.00	Full	36.00	24.00	18.00
8262	Industrial Size UB, 36" x 24"	Brite	12.00	Full	36.00	24.00	24.00
8264	Industrial Size UB, 48" x 24"	Brite	12.00	Mid	48.00	24.00	18.00
8265	Industrial Size UB, 48" x 24"	Brite	16.00	Mid	48.00	24.00	24.00
8267	Industrial Size UB, 60" x 24"	Brite	15.00	Small	60.00	24.00	18.00
8268	Industrial Size UB, 60" x 24"	Brite	20.00	Small	60.00	24.00	24.00
8263	Industrial Size UB, 36" x 24"	Brite	24.00	Mid	36.00	24.00	48.00
8266	Industrial Size UB, 48" x 24"	Brite	32.00	Mid	48.00	24.00	48.00
8269	Industrial Size UB, 60" x 24"	Brite	40.00	Small	60.00	24.00	48.00

## In-Frame Commercial Truck Boxes

Designed to be mounted between frame and truck rails, these boxes have pliable weather proof gaskets, keeping contents dry and ready to use.

- Provides low-profile access for storage of heavy chains, binders and tie-down straps
- Heavy-duty .100" Aluminum
- Available in either padlock or locking

**Note:** T-handle configuration in a variety of sizes

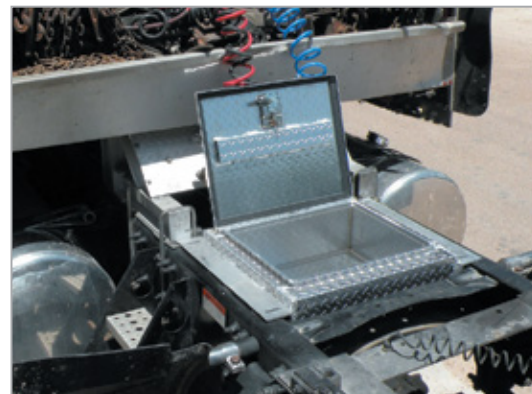

MODEL	DESCRIPTION	STYLE	CUBIC FT	SIZE	DIMENSIONS IN INCHES		
					A	B	C
6800	24" In-frame Truck Box, Paddle Latch, 18" Wide, Aluminum	Brite	2.00	Full	24.00	18.00	8.00
6801	24" In-frame Truck Box, T-Handle, 18" Wide, Aluminum	Brite	2.00	Full	24.00	18.00	8.00
6802	24" In-frame Truck Box, Paddle Latch, 22" Wide, Aluminum	Brite	3.10	Full	24.00	22.00	10.00
6803	24" In-frame Truck Box, T-Handle, 22" Wide, Aluminum	Brite	3.10	Full	24.00	22.00	10.00
6804	24" In-frame Truck Box, Paddle Latch, 24" Wide, Aluminum	Brite	2.70	Full	24.00	24.00	8.00
6805	24" In-frame Truck Box, T-Handle, 24" Wide, Aluminum	Brite	2.70	Full	24.00	24.00	8.00
6806	24" In-frame Truck Box, Paddle Latch, 36" Wide, Aluminum	Brite	5.00	Mid	24.00	36.00	10.00
6807	24" In-frame Truck Box, T-Handle, 36" Wide, Aluminum	Brite	5.00	Mid	24.00	36.00	10.00

## Liquid Storage Tanks

Offers a safe, convenient way to transport liquids. Each durable tank is hand welded for strength and reliability; available in heavy-duty aluminum; capacity ranges from 30 to 100 gallons; and configurations of rectangular, vertical or L-shaped to meet most truck applications.

- L-shaped tanks are designed to be used with full-size, cross-bed and saddle boxes
- Rectangular tanks are designed for full-size trucks
- Lockable vent caps to prevent contamination
- Secure steel plate bed flange mounting plates help anchor tanks
- Baffles reinforce tank walls and reduce fluid movement during transport
- Rust resistant Brite aluminum or black powder coat finishes
- Limited Lifetime Warranty

### Usage Notes:

- Not intended for transferring gasoline or other flammables
- Not intended for use as an auxiliary fuel tank
- Does not meet DOT specifications

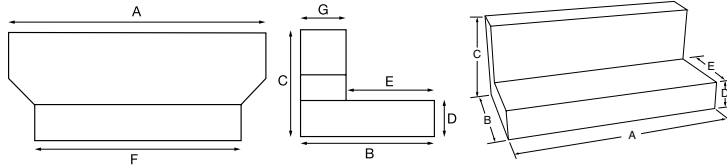

MODEL	DESCRIPTION	STYLE	CAPACITY	DIMENSIONS IN INCHES					
				A	B	C	D	E	F
3248*	48 Gallon L-Shaped Storage	Brite	48 gallon	30.00	31.25	25.50	8.50	20.50	—
3290*	80 Gallon L-Shaped Storage	Brite	80 gallon	48.00	31.25	25.50	8.50	20.50	—
3292*	92 Gallon L-Shaped Storage	Brite	92 gallon	54.00	31.25	25.50	8.50	20.50	—
3296*	96 Gallon Twin L-Shaped	Brite	96 gallon	60.00	31.25	25.50	8.50	20.50	—
3212*	100 Gallon L-Shaped Storage	Brite	100 gallon	60.00	31.00	25.00	8.50	20.50	48.00
3110*	Full Size Rectangular Storage	Brite	100 gallon	60.00	31.00	25.00	8.50	20.50	—

\*To order boxes in black, please add a "7" to the front of the part number  
Example: 3248 - 48 Gallon L-Shaped Tank would be 73248 - Black 48 Gallon L-Shaped

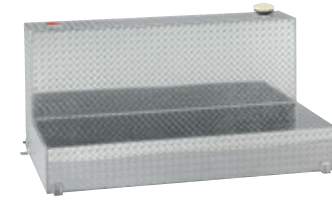

3292

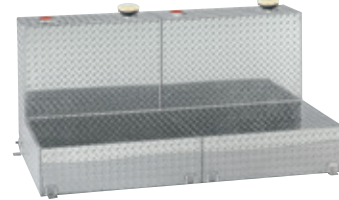

3296

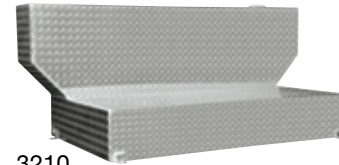

3210

## Combo, Rectangle, and Vertical Storage Tanks

Unique shape maximizes space and offers convenient liquid storage transferability with 80 or 90-gallon tanks combined with the storage capacity of a 48" and 56" storage chest.

### Chest Features:

- Aerodynamic domed-lid adds tank strength and reduces drag
- Removable, portable chest provides durable, secure storage for tools and accessories
- Self-rising lid provides easy access
- Lockable, 3-finger (stainless steel) paddle handles secure contents
- Weather-tight seal locks out moisture, dust and debris

MODEL	DESCRIPTION	STYLE	CAPACITY	DIMENSIONS IN INCHES		
				A	B	C
3155*	55 Gallon Rectangular Tank	Brite	55 Gallon	30.00	22.50	19.00
3198*	98 Gallon Rectangular Tank	Brite	98 Gallon	54.00	22.50	19.00
3199*	100 Gallon Rectangular Tank for CC	Brite	100 Gallon	48.00	23.00	23.00
3337*	37 Gallon Vertical Tank	Brite	37 Gallon	47.75	10.00	18.50
3350*	50 Gallon Vertical Liquid Tank	Brite	50 Gallon	60.00	12.00	18.00
3290*	80 Gallon L-Shaped 48" Box Combo	Brite	80 Gallon	48.00	31.25	25.50
73290	80 Gallon L-Shaped 48" Box Combo	Black	80 Gallon	48.00	31.25	25.20
3256*	90 Gallon L-Shaped 56" Box Combo	Brite	90 Gallon	54.00	31.25	25.50
3259	100 Gallon L-Shaped 48" Box Combo	Brite	100 Gallon	60.00	31.00	25.00
73249	100 Gallon L-Shaped 48" Box Combo	Black	100 Gallon	60.00	31.00	25.00

\*To order boxes in black, please add a "7" to the front of the part number  
Example: 3155 - 55 Gallon Rectangular Tank would be 73155 - Black 55 Gallon Rectangular Tank



3337



3292

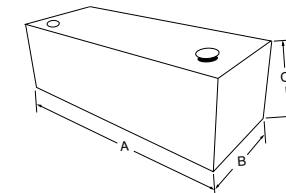



### Trailer Tongue Boxes

Ideal for storing boat, equestrian, motorcycle and snowmobile accessories, as well as construction equipment.

- Notched lid fits flush against trailer wall
- Secure locking double latch mechanism protects expensive equipment
- Strong 3 finger paddle handles provide easy single hand entry
- Available in rust resistant Brite aluminum or black powder coated finishes

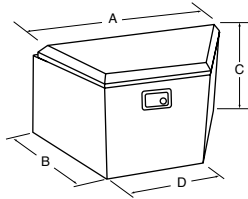

MODEL	DESCRIPTION	STYLE	CUBIC FT	SIZE	DIMENSIONS IN INCHES			
					A	B	C	D
6134T	21" Trailer Tongue Box	Brite	4.10	Mid	34.00	16.00	22.50	21.00
76134T	21" Trailer Tongue Box	Black	4.10	Mid	34.00	16.00	22.50	21.00
6120	16" Trailer Tongue Box	Brite	4.00	Compact	34.00	21.00	18.00	16.00
76120	16" Trailer Tongue Box	Black	4.00	Compact	34.00	21.00	18.00	16.00

### Hitch Cargo Carrier & Receiver Boxes

Constructed of heavy-duty steel, protected with a black powder coat finish for a weather-resistant finish.

- Durable 16-gauge heavy-duty steel floor
- Includes 1" tubular steel construction reflective safety labels
- Designed to fit 2" receiver hitch
- 500lb. weight capacity

**Note:** Hitch cargo carriers can be used with a variety of receiver or chest boxes and sold as a complete kit.



MODEL	DESCRIPTION	STYLE	CUBIC FT	SIZE	DIMENSIONS IN INCHES		
					A	B	C
4425	24" Cargo Carrier	Black	6.60	Full	23.50	48.50	10.00
4430	36" Cargo Carrier	Black	7.30	Full	23.50	53.50	10.00
4450	54" Cargo Carrier	Black	8.00	Full	23.50	58.50	10.00

DISCLAIMER: Load capacity SHOULD NOT exceed the vehicle manufacturer cargo and/or entire vehicle capacity rating. Consult vehicle manufacturer for capacity ratings



## Steel Cross Bed Boxes

### Steel Overview Features:

- 22-gauge steel
- Paints are electrostatically applied to maximize resistance to abrasion and corrosion
- Aerodynamic, domed-lid adds strength
- Ethafoam mounting strips protect truck's finish
- Sturdy, one-piece, no sag base design
- 90° opening lid is included on all aluminum and steel cross beds
- Side pockets are included on all Cross Beds except low profile models



## Steel Cross Bed Boxes

Offering one of the largest selections for professionals needing rugged, reliable truck storage. Boxes are constructed with heavy-duty, 22-gauge steel and feature an aerodynamic, domed-lid adding box strength while reducing drag. The long single piano hinge box lid features a self-rising lid enabling convenient access and single-hand entry—operating smoothly even in the harshest weather conditions.

- Self-rising lid, stays open at a 90° angle
- Easy grip, 3-finger double latch, lockable paddle handles protect content
- Weatherproof pliable gaskets seal tightly to keep moisture out
- Electrostatically applied paint maximizes resistance to abrasion and corrosion
- Ethafoam mounting strips protect finish
- Available in sizes: 51", 60" and 72"
- White or black powder coat finishes

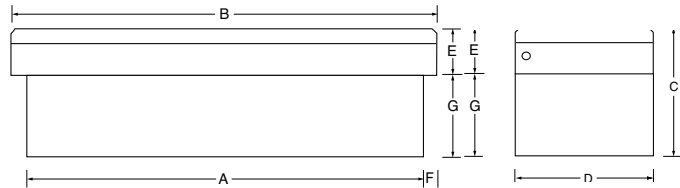

MODEL	DESCRIPTION	STYLE	CUBIC FT	SIZE	DIMENSIONS IN INCHES						
					A	B	C	D	E	F	G
86550	61" Cross Bed, Single Lid Box	White	7.70	Mid	51.25	60.75	13.00	20.50	7.00	4.25	6.00
76500	61" Cross Bed, Single Lid Box	Black	7.70	Mid	51.25	60.75	13.00	20.50	7.00	4.25	6.00
86400	70" Cross Bed, Single Lid Box	White	11.10	Full	60.75	70.25	15.50	20.50	7.00	4.25	10.00
86401	70" Cross Bed, Single Lid Box	Black	11.10	Full	60.75	70.25	15.50	20.50	7.00	4.25	10.00
86499	72" Cross Bed, Single Lid Box	White	11.50	Full	62.75	72.25	15.50	20.50	7.00	4.25	10.00
76599	72" Cross Bed, Single Lid Box	Black	11.50	Full	62.75	72.25	15.50	20.50	7.00	4.25	10.00
86550	61" Cross Bed, Gull-Wing Box, Steel	White	7.70	Mid	51.25	60.75	13.00	20.50	7.00	4.25	6.00
76550	61" Cross Bed, Gull-Wing Box, Steel	Black	7.70	Mid	51.25	60.75	13.00	20.50	7.00	4.25	6.00
86450	70" Cross Bed, Gull-Wing Box, Steel	White	11.90	Full	60.75	70.25	15.50	20.50	7.00	4.25	10.00
86451	70" Cross Bed, Gull-Wing Box, Steel	Black	11.90	Full	60.75	70.25	15.50	20.50	7.00	4.25	10.00
8112001	70" Cross Bed, Single Lid, 16" Wide	White	7.30	Full	61.00	70.25	13.00	16.00	5.50	4.25	7.50
7112001	70" Cross Bed, Single Lid, 16" Wide	Black	7.30	Full	61.00	70.25	13.00	16.00	5.50	4.25	7.50



Available in both single lid & gull-wing styles

76550

### Fender Well & Side Bin Boxes

Keep your truck bed and cab clear, while keeping valuables safe and out of sight. Double your storage capacity with fender well or side bin boxes for both sides of your truck bed; the universal lid allows left or right mounting.

- Secure, 3-finger locking paddle handles
- Strong, lockable T-handle protects valuables on fender box
- Keyed locks protect valuables
- Weather-tight gaskets keep moisture, dirt, and debris out
- Ethafoam mounting strips protect the truck's finish
- Available in sizes: 48" and 70"
- Diamond-tread, brite aluminum or black powder coat finishes

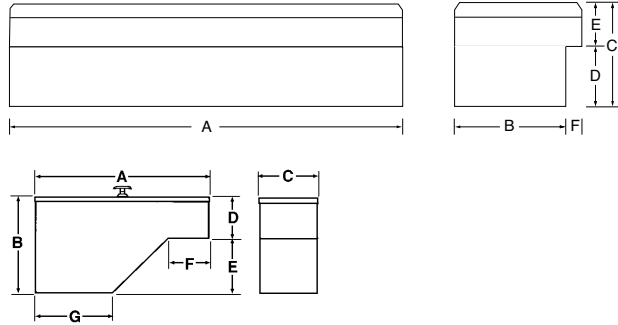

MODEL	DESCRIPTION	STYLE	CUBIC FT	SIZE	DIMENSIONS IN INCHES					
					A	B	C	D	E	F
88230	48" Fender Well Box	White	11.60	Mid	48.25	21.00	8.50	9.00	12.00	21.00
788230	48" Fender Well Box	Black	11.60	Mid	48.25	21.00	8.50	9.00	12.00	21.00
86748	48" Side Bin Box	White	4.10	Mid	48.25	8.00	12.00	6.00	6.00	4.25
76748	48" Side Bin Box	Black	4.10	Mid	48.25	8.00	12.00	6.00	6.00	4.25
86772	70" Side Bin Box	White	7.60	Full	70.25	8.00	15.00	8.00	7.00	4.25
76772	70" Side Bin Box	Black	7.60	Full	70.25	8.00	15.00	8.00	7.00	4.25

### Flush Mount Boxes

Provides maximum rear window visibility for unobstructed view of the road. Front and side walls are angled to accommodate sloped walls and wheel wells. Offset lid construction allows lid to open fully without back wall interference.

- 16-gauge steel construction
- White or black powder coated finishes

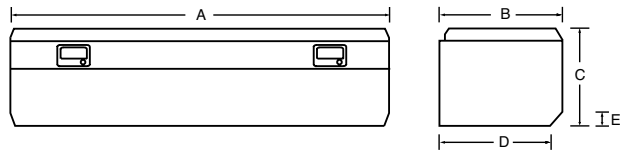

MODEL	DESCRIPTION	STYLE	CUBIC FT	SIZE	DIMENSIONS IN INCHES				
					A	B	C	D	E
86548	48" Flush Mount Box	White	9.70	Mid	48.00	20.50	19.00	16.00	4.00
76548	48" Flush Mount Box	Black	9.70	Mid	48.00	20.50	19.00	16.00	4.00
86460	60" Flush Mount Box	White	10.90	Full	61.00	20.50	19.00	16.00	4.00
76461	60" Flush Mount Box	Black	10.90	Full	61.00	20.50	19.00	16.00	4.00



### Top Mount Boxes

Designed for strength and durability with 16-gauge steel, weather proof gaskets, and locking stainless steel flush mount T-handles. Front opening protects contents from the elements.

- Secure, locking stainless steel, flush mount T-handles
- Available in sizes: 48", 60", 72" and 90"
- White or black powder coat finishes

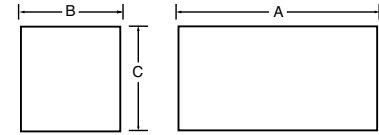

MODEL	DESCRIPTION	STYLE	CUBIC FT	SIZE	DIMENSIONS IN INCHES		
					A	B	C
86148	48" Top Mount Box	White	5.70	Compact	48.00	12.75	16.00
76148T	48" Top Mount Box	Black	5.70	Compact	48.00	12.75	16.00
86160	60" Top Mount Box	Black	7.10	Mid	60.00	12.75	16.00
76160	60" Top Mount Box	White	7.10	Mid	60.00	12.75	16.00
86172	72" Top Mount Box	White	8.50	Mid/Full	72.00	12.75	16.00
76172	72" Top Mount Box	Black	8.50	Mid/Full	72.00	12.75	16.00
86190	90" Top Mount Box	White	10.60	Full	90.00	12.75	16.00
76190	90" Top Mount Box	Black	10.60	Full	90.00	12.75	16.00

76148

86148

### Trailer Tongue Boxes

Ideal for storing boat, equestrian, motorcycle and snowmobile accessories, as well as construction equipment.

- Great solution for unused space
- Notched-lid fits flush against trailer wall
- Secure locking mechanism
- 3-Finger, double-locking, lockable paddle handles
- Available in white or black powder coated steel finishes

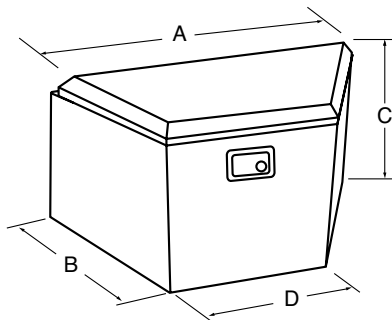

6234

76220

MODEL	DESCRIPTION	STYLE	CUBIC FT	SIZE	DIMENSIONS IN INCHES			
					A	B	C	D
6234	21" Trailer Tongue Box	White	4.10	Mid	34.00	16.00	22.50	21.00
76234	21" Trailer Tongue Box	Black	4.10	Mid	34.00	16.00	22.50	21.00
6220	16" Trailer Tongue Box	White	4.00	Full	34.00	21.00	18.00	16.00
76220	16" Trailer Tongue Box	Black	4.00	Full	34.00	21.00	18.00	16.00

## Steel Underbody Boxes

Underbody boxes provide a secure, convenient storage solution.

- Weatherproof gasket prevents leakage
- Stainless steel chain supports allow lid to remain open at a 90° angle
- Strong, lockable stainless steel T-handle protects valuables
- White or black powder coat finishes

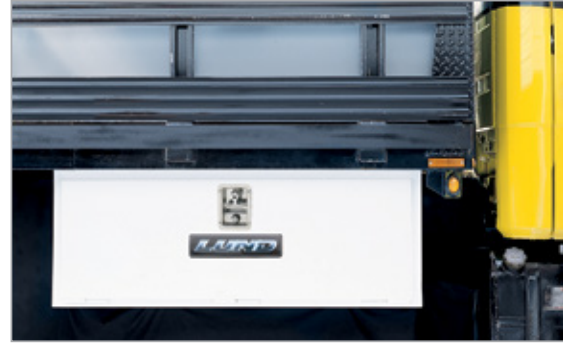
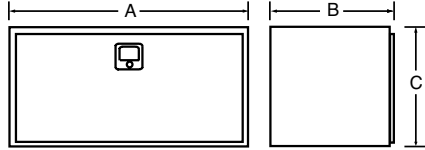

MODEL	DESCRIPTION	STYLE	CUBIC FT	SIZE	DIMENSIONS IN INCHES		
					A	B	C
86224	24" Underbody Box	White	4.70	Compact	24.00	18.75	18.00
76224	24" Underbody Box	Black	4.70	Compact	24.00	18.75	18.00
6130	30" Underbody Box	White	5.90	Mid	30.00	18.75	18.00
76130	30" Underbody Box	Black	5.90	Mid	30.00	18.75	18.00
86236	36" Underbody Box	White	7.00	Mid	36.00	18.75	18.00
76236	36" Underbody Box	Black	7.00	Mid	36.00	18.75	18.00
86248	48" Underbody Box	White	9.40	Full	48.00	18.75	18.00
76248	48" Underbody Box	Black	9.40	Full	48.00	18.75	18.00
86260	60" Underbody Box	White	11.70	Full	60.00	18.75	18.00
76260	60" Underbody Box	Black	11.70	Full	60.00	18.75	18.00





## LUND Steel Liquid Storage Tanks

LUND Liquid Storage Tanks offer a safe and convenient way to transport liquids. Each tank is constructed of 14-gauge steel, hand-welded for strength and reliability; capacity ranges from 30 to 190 gallons; and configurations of rectangular, vertical or L-shaped to meet most truck applications.

### L-Shaped Tank Features:

- Designed to be used with full-size, cross-bed and saddle boxes
- Lockable vent caps to help eliminate tampering
- Easy installation with heavy-duty lifting loops
- Secure steel plate bed flange mounting plates help anchor tanks
- Baffles reduce fluid movement during transport and reinforce tank walls
- Ethafoam mounting strips protect truck's finish
- Sturdy, one-piece, no sag base design
- White or black powder coated finishes
- Backed by Lund's Limited Lifetime Warranty

### Usage Notes:

- Not intended for transferring gasoline or other flammables
- Not intended for use as an auxiliary fuel tank
- Does not meet DOT specifications

Maximize your space! COMBO Liquid Storage L-Shaped Tank and Chest Tanks offer convenient liquid storage transferability with 80 to 90 gallon tanks, combined with the storage capacity of our 48" and 56" storage chests in one complete unit.

### Chest Features:

- Removable, portable chest provides durable, secure storage for tools and accessories
- Aerodynamically designed domed-lid add strength
- Easy access with self-rising lid
- Stainless steel paddle handles
- Weather-tight seals lock-out moisture, dust, and debris



83596



73592



83596



86590

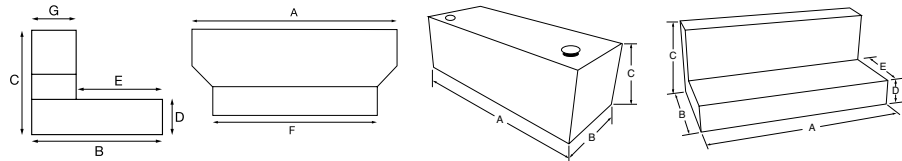

BLACK	WHITE	DESCRIPTION	STYLE	CAPACITY	DIMENSIONS IN INCHES					
					A	B	C	D	E	F
73548	83548	48 Gallon Any Size L-Shaped	Black/White	48 gallon	28.50	31.00	25.00	8.50	20.50	–
73580	83580T	80 Gallon Full Size L-Shaped	Black/White	80 gallon	48.00	31.00	25.00	8.50	20.50	–
73592	83592T	92 Gallon Full Size L-Shaped	Black/White	92 gallon	54.00	31.00	25.00	8.50	20.50	–
–	83596T	96 Gallon Full Size L-Shaped	White	96 gallon	57.00	31.00	25.00	8.50	20.50	–
73510	83510T	100 Gallon Full Size L-Shaped	Black/White	100 gallon	60.00	31.00	25.00	8.50	20.50	48.00
73098	83098	100 Gallon Full Size Rectangular	Black/White	100 gallon	60.00	31.00	25.00	8.50	20.50	–
73055	83055	55 Gallon Any Size Rectangular	Black/White	55 gallon	30.00	22.50	19.25	–	–	–
73099	83099	98 Gallon Full Size Rectangular	Black/White	98 gallon	54.00	22.50	19.25	–	–	–
73010	83010T	100 Gallon Full Size Rectangular	Black/White	100 gallon	48.00	23.00	23.00	–	–	–
73090	83090	190 Gallon Full Size Rectangular	Black/White	190 gallon	60.00	27.00	27.00	–	–	–
73737	83737	37 Gallon Full-Mid Size Vertical Tank	Black/White	37 gallon	47.75	10.50	19.00	–	–	–
73750	83750	50 Gallon Full-Mid Size Vertical Tank	Black/White	50 gallon	60.00	12.00	18.00	–	–	–
76648	86648	80 Gallon Full-Mid Combo L-Shaped Box	White	80 gallon	48.00	31.25	25.50	–	–	–
–	83592T	90 Gallon Full Size L-Shaped	White	90 gallon	54.00	31.25	25.50	–	–	–
76590	86590T	90 Gallon Full-Mid Combo L-Shaped Box	White	90 gallon	54.00	31.25	25.50	–	–	–
76510	86510	100 Gallon Full-Mid Combo L-Shaped Box	Black/White	100 gallon	60.00	31.00	25.00	–	–	–

### Structured Foam Lid (SFL) Series Cross Beds Boxes

Available for mid to full-size trucks, these boxes offer the strongest, most rigid box lid on the market able to withstand up to 500 lbs. of cargo weight and years of wear and tear. Boxes provide plenty of room for large tools and equipment, feature side pocket organizers and a heavy-duty, sliding tray.

- Structured, foam-filled lid will not warp or bend
- Easy grip, 3-finger double latch, stainless steel locking paddle handles
- Weather-tight seal keeps moisture out
- Linkage cover separates box contents from latch system
- Optional push button rotary latch available on several models



5400DBT



Push buttons with rotary latch (PB) available on several models

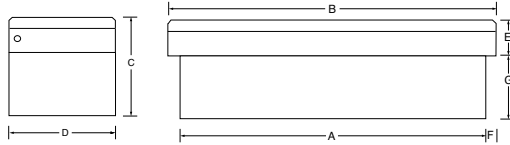

BRITE	BLACK	DESCRIPTION	CUBIC FT	SIZE	DIMENSIONS IN INCHES						
					A	B	C	D	E	F	G
5350PB	75350PB	60" Cross Bed Box, Push Button	8.30	Mid	51.50	60.75	12.75	20.50	5.00	4.25	7.75
5350SBT	75350SBT	60" Cross Bed Box, Beveled Bottom, Low Profile	8.30	Mid	51.50	60.75	12.75	20.50	5.00	4.25	7.75
5350T	75350T	60" Cross Bed Box	8.30	Mid	51.50	60.75	12.75	20.50	5.00	4.25	7.75
5400PB	75400PB	70" Cross Bed Box, Push Button	11.80	Full	61.00	70.25	15.50	20.50	5.50	4.25	10.00
5400T	75400T	70" Cross Bed Box	11.80	Full	61.00	70.25	15.50	20.50	5.50	4.25	10.00
5400LPT	75400LPT	70" Cross Bed Box, Low Profile	11.80	Full	61.00	70.25	15.50	20.50	5.50	4.25	10.00
5400DBPB	75400DBPB	70" Cross Bed Box, Deep Well, Push Button	13.60	Full/Deep	61.00	70.25	18.00	20.50	5.50	4.25	12.50
5400DBT	75400DBT	70" Cross Bed Box, Deep Well	13.60	Full/Deep	61.00	70.25	18.00	20.50	5.50	4.25	12.50
5199PB	75199PB	72" HD Cross Bed Box, Push Button	12.20	HD Full	63.00	72.25	18.00	20.50	5.50	4.25	10.00
5499T	75199T	72" HD Cross Bed Box	12.20	HD Full	63.00	72.25	18.00	20.50	5.50	4.25	10.00

### Structured Foam Lid (SFL) Series Flush Mounts Boxes

Convenient flush mount design provides an unobstructed view of the road, while keeping tools and equipment close at hand.

- Angled at bottom of front and side walls to accommodate sloped bed walls and wheel wells
- Offset lid construction allows lid to open fully without back wall interference
- Strong, 3-finger double latch with lockable paddle handles
- Available in sizes: 47", 56" and 60"
- Diamond-tread, brite aluminum finish



4460T

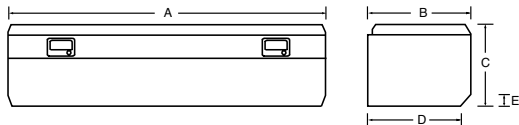

MODEL	DESCRIPTION	STYLE	CUBIC FT	SIZE	DIMENSIONS IN INCHES				
					A	B	C	D	E
79447	47" Flush Mount Box	Black	6.90	Mid	47.75	20.50	18.00	16.00	4.00
4455T	56" Flush Mount Box	Brite	9.70	Full	56.75	20.50	18.00	16.00	4.00
74455	56" Flush Mount Box	Black	9.70	Full	56.75	20.50	18.00	16.00	4.00
4460	60" Flush Mount Box	Brite	10.60	Full	60.75	20.50	19.25	16.00	4.00
74460	60" Flush Mount Box	Black	10.60	Full	60.75	20.50	19.25	16.00	4.00



79447T

## Commercial PRO HD Cross Bed Boxes

Constructed with heavy-duty .080 diamond plate aluminum or 16-gauge steel reinforced by expert craftsman hand TIG welded seams. PRO HD boxes keep equipment safe and dry with a reinforced and insulated high dome lid featuring an ultra-tight weatherproof bulb seal, adjustable J-bolt striker mount, and heavy-duty aluminum piano-style hinge that bolts lid to box body for unequalled strength and durability - even in the coldest weather.

### Aluminum:

- .080" diamond tread plated aluminum – 30% thicker than standard boxes
- Domed, aerodynamic lid adds strength, reduces drag
- Commercial push button locking rotary latch for easy single-hand use

### Steel:

- Constructed with heavy-duty 16-gauge steel
- Secure, 3-finger lockable double latch, paddle handles
- Steel hinges for long life in all weather conditions

### Features for both Aluminum and Steel PRO HD Boxes:

- Full 90° automatic self-rising lid, easy access
- Steel D-ring tie downs
- Side pockets organizers
- Single lid and gull-wing styles available
- Protective linkage cover
- Rigid foam filled lid for increased box strength
- Commercial D-shaped weather-resistant gaskets keep moisture out
- No-weld installation bolts lid onto box body for heavy rugged long life
- Sectioned, movable, and lockable steel tray
- Includes no-drill mounting hardware and non-skid mat
- Corrosion- and abrasion-resistant
- White or black powder coated finishes

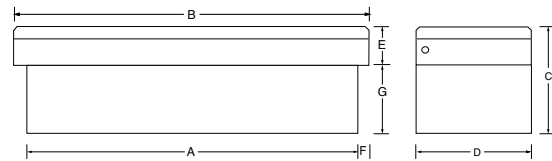

MODEL	DESCRIPTION	STYLE	CUBIC FT	SIZE	DIMENSIONS IN INCHES						
					A	B	C	D	E	F	G
07800T	70" Commercial Cross Bed, Single Lid HD, Aluminum	Brite	11.70	Full	61.00	70.50	15.00	21.00	5.25	4.00	9.75
707800W	70" Commercial Cross Bed, Single Lid HD, Aluminum	White	11.70	Full	61.00	70.50	15.00	21.00	5.25	4.00	9.75
707800	70" Commercial Cross Bed, Single Lid HD, Aluminum	Black	11.70	Full	61.00	70.50	15.00	21.00	5.25	4.00	9.75
08111	70" HD Commercial Cross Bed, Single Lid HD Steel	White	12.70	Full	61.00	70.00	16.75	20.50	5.00	4.00	11.75
78111T	70" HD Commercial Cross Bed, Single Lid HD Steel	Black	12.70	Full	61.00	70.00	16.75	20.50	5.00	4.00	11.75
88120	70" HD Commercial Gull-Wing Cross Bed, HD Steel	White	12.70	Full	61.00	70.00	16.75	20.50	5.00	4.00	11.75
78120T	70" HD Commercial Gull-Wing Cross Bed, HD Steel	Black	12.70	Full	61.00	70.00	16.75	20.50	5.00	4.00	11.75



## Commercial PRO HD Side Bin Boxes

Constructed with heavy duty .080 diamond plate aluminum or 16-gauge steel reinforced by hand TIG welded seams. Side bin boxes install along truck bed rail allowing for full view of the road, and convenient storage and access to tools and equipment.

### Aluminum:

- .080" diamond tread plated aluminum – 30% thicker than standard boxes
- Domed aerodynamic lid reduces drag

### Steel:

- Constructed with heavy duty 16-gauge steel
- Steel hinges for long life in all weather conditions

### Features for both aluminum and steel PRO HD Boxes:

- Easy access with self-rising lid
- Secure, 3-finger lockable double latch, stainless steel paddle handles
- Steel D-ring tie downs
- Interior pockets for extra storage
- Protective linkage cover
- Rust and abrasion resistant
- Foam-filled lid for increased box strength
- Commercial D-shaped weather resistant gaskets keep moisture out
- No-weld installation bolts lid onto box body for heavy rugged long life
- Brite aluminum, black or white powder coat finishes



07946T



88950

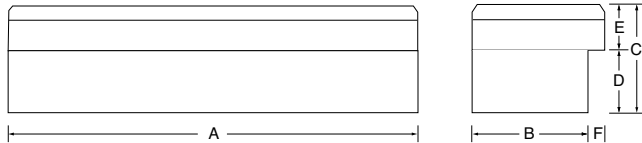

MODEL	Description	Style	CUBIC FT	SIZE	DIMENSIONS IN INCHES					
					A	B	C	D	E	F
07946T	50" HD Commercial Side Bin, Aluminum	Brite	3.90	Mid	50.50	8.00	13.75	8.00	5.75	4.25
707946W	50" HD Commercial Side Bin, Aluminum	White	3.90	Mid	50.50	8.00	13.75	8.00	5.75	4.25
707946	50" HD Commercial Side Bin, Aluminum	Black	3.90	Mid	50.50	8.00	13.75	8.00	5.75	4.25
07959T	60" HD Commercial Side Bin, Aluminum	Brite	4.70	Full	60.50	8.00	13.75	8.00	5.75	4.25
707959W	60" HD Commercial Side Bin, Aluminum	White	4.70	Full	60.50	8.00	13.75	8.00	5.75	4.25
707959	60" HD Commercial Side Bin, Aluminum	Black	4.70	Full	60.50	8.00	13.75	8.00	5.75	4.25
88950	50" Pro HD Side Bin, Steel	Brite	3.30	Mid	50.50	8.00	11.75	6.25	5.00	4.25
78950	50" Pro HD Side Bin, Steel	Black	3.30	Mid	50.50	8.00	11.75	6.25	5.00	4.25
88960	60" Pro HD Side Bin, Steel	Brite	4.70	Full	60.50	8.00	13.75	8.00	5.75	4.25
78960	60" Pro HD Side Bin, Steel	Black	4.70	Full	60.50	8.00	13.75	8.00	5.75	4.25

Aluminum brite boxes offer push button, lockable latches



## Commercial PRO Steel Window Grill and Headache Rack

Constructed with heavy-duty, 16-gauge steel, the contoured steel frame provides the perfect structure to help distribute load, haul large loads and ladders, and easily transition off and on the truck bed. The louvered grill design provides rear window protection, and shades the truck's interior.

- Louvered design protects rear window from accidental breakage
- Provides shade and protection for cab interior
- Lights mount easily
- Black or white powder coated finishes for years of rust resistant service

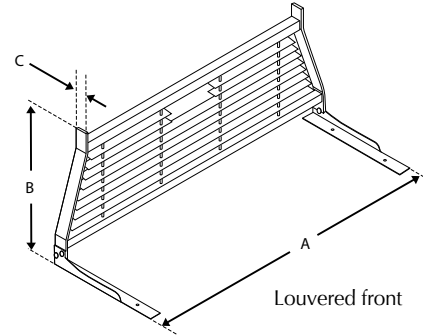
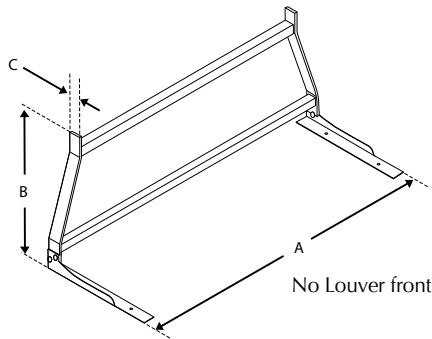

MODEL	APPLICATIONS	STYLE	SIZE	DIMENSIONS IN INCHES		
				A	B	C
07150	FRONT – Ford Super Duty, Dodge Ram, Chevy Silverado, GMC Sierra, Toyota Tundra, Nissan Titan	White	Full	71.00	27.75	3.00
77150	FRONT – Ford Super Duty, Dodge Ram, Chevy Silverado, GMC Sierra, Toyota Tundra, Nissan Titan	Black	Full	71.00	27.75	3.00
07160	REAR – Ford Super Duty, Dodge Ram, Chevy Silverado, GMC Sierra, Toyota Tundra, Nissan Titan	White	Full	68.00	27.75	3.00
77160	REAR – Ford Super Duty, Dodge Ram, Chevy Silverado, GMC Sierra, Toyota Tundra, Nissan Titan	Black	Full	68.00	27.75	3.00
07110	FRONT – 2004 and Later F-150	White	Full	71.00	26.13	3.00
77110	FRONT – 2004 and Later F-150	Black	Full	71.00	26.13	3.00
07120	REAR – 2006 and Later F-150	White	Full	71.00	26.13	3.00
77120	REAR – 2006 and Later F-150	Black	Full	71.00	26.13	3.00
07130	NO LOUVER FRONT – Ford Super Duty, Dodge Ram, Chevy Silverado, GMC Sierra, Toyota Tundra, Nissan Titan	White	Full	71.00	27.75	3.00
77130	NO LOUVER FRONT – Ford Super Duty, Dodge Ram, Chevy Silverado, GMC Sierra, Toyota Tundra, Nissan Titan	Black	Full	71.00	27.75	3.00
07140	NO LOUVER FRONT – 2004 and Later F-150	White	Full	71.00	26.13	3.00
77140	NO LOUVER FRONT – 2004 and Later F-150	Black	Full	71.00	26.13	3.00

### Job Site Boxes

LUND Job Site Boxes are packed with features to last a lifetime. Reinforced lid resists bending, while self-enclosed hinge protects box from attempted break ins. These box lids are almost impossible to pry open.

- 16-gauge steel construction
- Secure on-site storage
- Self-enclosed hinge systems
- Recessed padlock inlets
- Fold-down, recessed side handles
- Rust and corrosion resistant powder coat finishes

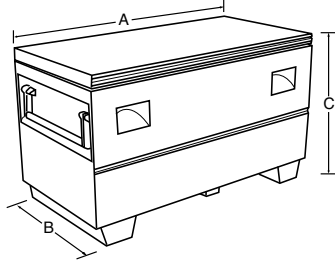

08048Y



08060G

All boxes available in industrial grey, yellow and black

MODEL	DESCRIPTION	STYLE	CUBIC FT	SIZE	DIMENSIONS IN INCHES			
					A	B	C	
08036G	36" HD Small Job Site	Grey	6.20	Small	32.00	19.00	17.75	17.75
08036Y	36" HD Small Job Site	Yellow	6.20	Small	32.00	19.00	17.75	17.75
708036	36" HD Small Job Site	Black	6.20	Small	32.00	19.00	17.75	17.75
08048G	48" HD Medium Job Site	Grey	18.70	Medium	48.00	24.00	28.00	28.00
08048Y	48" HD Medium Job Site	Yellow	18.70	Medium	48.00	24.00	28.00	28.00
708048	48" HD Medium Job Site	Black	18.70	Medium	48.00	24.00	28.00	28.00
08060G	60" HD Large Job Site	Grey	23.80	Large	59.50	24.00	28.75	28.75
08060Y	60" HD Large Job Site	Yellow	23.80	Large	59.50	24.00	28.75	28.75
708060	60" HD Large Job Site	Black	23.80	Large	59.50	24.00	28.75	28.75

### Job Site Chests

Portability and security in one box offering plenty of room for large or multiple pieces of equipment.

- 22-gauge steel
- Easy-carry side handles
- White or black powder coated finishes

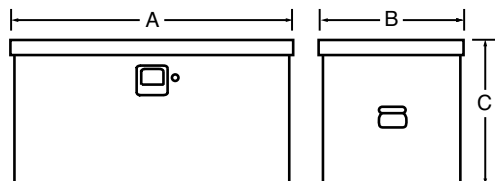

88024



78048

MODEL	DESCRIPTION	STYLE	CUBIC FT	SIZE	DIMENSIONS IN INCHES		
					A	B	C
88024T	24" LD Small Job Chest	White	2.70	Small	24.25	15.50	12.50
78024T	24" LD Small Job Chest	Black	2.70	Small	24.25	15.50	12.50
88048	48" LD Large Job Chest	White	8.00	Large	42.75	18.50	17.50
78048	48" LD Large Job Chest	Black	8.00	Large	42.75	18.50	17.50

## Commercial PRO Steel Cross Bed Boxes

Built with 16-gauge steel, these boxes are engineered for rugged use, suited for toughest needs of the professional contractor. Heavy-duty materials withstand rust, corrosion and are weather-resistant.

- Single-lid features secure, easy grip, 3-finger locking double-latch paddle handles
- Gull-Wings offer push button rotary style locking latches for easy single-hand entry
- Available in sizes: 51", 60", and 61"
- White or black powder coat finishes
- Backed by a Limited Lifetime Warranty



86600



86151

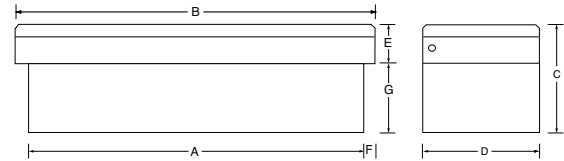

MODEL	DESCRIPTION	STYLE	CUBIC FT	SIZE	DIMENSIONS IN INCHES						
					A	B	C	D	E	F	G
86350	60" Cross Bed Box, Paddle Handle	White	8.70	Mid	51.25	60.75	13.00	20.50	7.00	4.25	6.00
86351	60" Cross Bed Box, Push Button	White	8.70	Mid	51.25	60.75	13.00	20.50	7.00	4.25	6.00
86600	70" Cross Bed Box, Paddle Handle	White	13.00	Full	60.75	70.25	17.00	20.50	7.00	4.25	10.00
86601	70" Cross Bed Box, Push Button	White	13.00	Full	60.75	70.25	17.00	20.50	7.00	4.25	10.00
86151DB	70" Cross Bed Deep Box, Push Button	White	13.20	Full	61.00	70.25	18.00	20.50	5.00	4.25	12.50
86600W	70" Cross Bed Box, Paddle Handle	White	11.60	Full	60.75	70.25	15.00	20.50	7.00	4.25	8.00
86601W	70" Cross Bed Box, Push Button	White	11.60	Full	60.75	70.25	15.00	20.50	7.00	4.25	8.00
86150	70" Gull-Wing Cross Bed Box, Paddle Handle	White	13.00	Full	60.75	70.25	17.00	20.50	7.00	4.25	10.00
86151	70" Gull-Wing Cross Bed Box, Push Button	White	13.00	Full	60.75	70.25	17.00	20.50	7.00	4.25	10.00
86250	60" Gull-Wing Cross Bed Box, Paddle Handle	White	8.70	Mid	51.25	60.75	13.00	20.50	7.00	4.25	6.00
86251	60" Gull-Wing Cross Bed Box, Push Button	White	8.70	Mid	51.25	60.75	13.00	20.50	5.00	4.25	6.00

Several new Cross Bed Boxes available with push button, lockable latches

Accessories, Maintenance & Repair Parts



5213

**TAM104-MAT**

- Non-skid surface for the inside of any truck box
- 1 year limited warranty



5214

**TAT108-Sliding Tray**

- Keeps tools organized inside truck boxes
- 1 year limited warranty



5220

**TAGS111-Shocks**

- Replacement shocks for truck tool boxes
- 1 year limited warranty



5215

**TAP102-Truck Box Polish**

Keeps truck boxes looking like new

- 8oz
- Cleans, protects, beautifies
- No oily residue-will not smudge or leave fingerprints
- Ideal for aluminum, chrome, plastic, painted metal, porcelain, and enameled surfaces
- This water emulsion compound cleans surfaces, protective finish that resists dirt

5210



**TDRA110-D-Ring Kit with Hardware**

- 1 year limited warranty.

5211T



**TTL109-Replacement T-Handle**

- 1 year limited warranty

5221



**TAPFC107-VENT CAP**

Replacement vent cap for liquid storage tanks

- Lockable

5219



**TAA100-Anchor**

- Easy-to-install anchors
- 1 year limited warranty

5217



**TAMK105-Truck Box Mounting Kit**

- No-drill mounting kit for any truck box
- 1 year limited warranty

5218

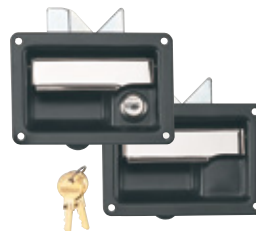

**TABP103-Latches**

Replacement latches for truck tool boxes

- 1 year limited warranty

5212



**TPHC108-Replacement Paddle Handle Cam with Key**

- 1 year limited warranty



# Why Add Armor-X™ Coating?

Armor-X Coating is a thick, seamless elastic polyurethane lining designed to extend the life of your box under harsh conditions. Armor-X Coating applied to LUND specialty boxes will protect against petroleum, chemicals, corrosion and abrasion.

Armor-X Coating formulations are 100% solids, environmentally friendly, contain no VOCs, CFCs, or solvents.



ARMOR-X™ COATING

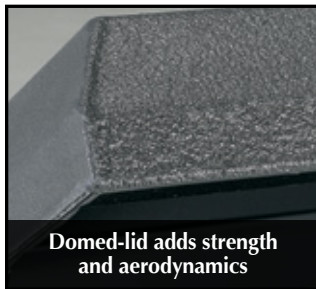

**Domed-lid adds strength and aerodynamics**



**Strong, lockable paddle handles protect valuables**



**Gas cylinders allow easy access**



**Weatherproof gasket prevents leakage**

## Benefits of LUND's Armor-X Coating: Specialty Boxes

- Bonds permanently with steel and extends the life of your specialty box
- Coatings are guaranteed not to crack or peel
- Shrugs off impact and protects against scratches
- Delivers superior toughness, skid resistant
- Non-porous, easy to clean
- 100% resistant to water, oil, grease, chemicals, acids, fertilizers and salts

Armor-X Coating applied to LUND boxes fit most full-size trucks, constructed with heavy-duty steel with hand TIG welded seams. Reinforced and insulated lid, ultra-tight weatherproof seal, adjustable J-bolt striker mount, and heavy-duty aluminum piano-style hinge bolting lid to box body provide unequalled strength and durability, even in the coldest weather.

Easy, no-drill, J-hook mounting hardware and rubber mat are included.

- Self-rising lid, easy access
- 3-Finger, stainless steel, lockable double-latch paddle handles
- Interior pockets for additional storage
- Commercial D-shaped rubber weather-resistant seal
- Lid bolts onto the body (not spot welded) for extended life
- Ethafoam mounting strips protect truck's finish
- Sturdy, one-piece, no-sag base design
- Ample storage space under truck box
- Full lid and gull-wing design
- Backed by Limited Lifetime Warranty
- Flush mount design provides an unobstructed view of the road
- Angled at bottom of front and side walls to accommodate sloped bed walls and wheel wells
- Offset lid construction allows lid to open fully without back wall interference



## Armor-X Coating, Extra Protection

ONLY LUND boxes feature Armor-X Coating for that extra, heavy-duty sealed protection from leaks, dents, scratches, corrosion, chemicals and many other hazards.

Armor-X Coating formulations are 100% solids, environmentally friendly, contain no VOCs, CFCs, or solvents.



### Armor-X Coating: Cross Bed Boxes

Our Armor-X Coating cross bed boxes allow ample storage underneath with models in Full Lid or Gull Wing.

- Heavy-duty steel construction
- Sturdy, one-piece, no sag base design
- Aerodynamic-domed lid adds strength, reduces drag
- Easy access with self-rising lid
- Strong, lockable paddle handles
- Ethafoam mounting strips protect truck's finish
- Fits most full-size trucks
- Weather proof gasket prevents leakage



6150RH

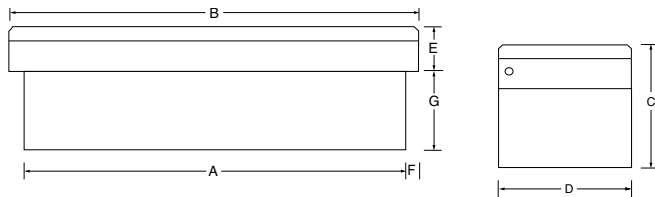

MODEL	DESCRIPTION	STYLE	CUBIC FT	SIZE	DIMENSIONS IN INCHES						
					A	B	C	D	E	F	G
6150RH	70" Cross Bed Single Lid	Black	12.90	Full	60.75	70.25	15.50	20.50	7.00	4.25	9.75
6451RH	70" Cross Bed Gull-Wing	Black	12.90	Full	60.75	70.25	15.50	20.50	7.00	4.25	9.75

### Armor-X Coating: Flush Mount Box

Flush mount design provides an unobstructed view of the road. Angled at bottom of front and side walls to accommodate sloped bed walls and wheel wells. Offset lid construction allows lid to open fully without back wall interference.

- Sturdy, one-piece, no sag base design
- Aerodynamic-lid adds strength, reduces drag
- Easy access with self-rising lid
- Strong, lockable paddle handles
- Ethafoam mounting strips protect truck's finish
- Weatherproof gasket prevents leakage



6461RH

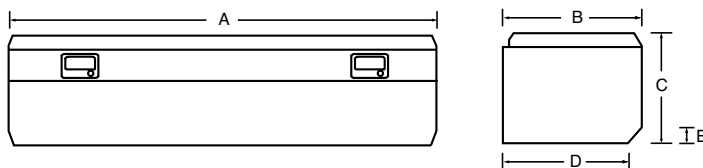

MODEL	DESCRIPTION	STYLE	CUBIC FT	SIZE	DIMENSIONS IN INCHES				
					A	B	C	D	E
6461RH	60" Flush Mount, Single Lid	Black	10.70	Mid	61.00	20.50	19.00	16.00	4.00

### Armor-X Coating: Trailer Tongue Boxes

Ideal for storing boat, personal water craft, equestrian, motorcycle and snowmobile accessories, as well as construction equipment. Trailer tongue boxes are a great solution for unused space.

- Notched lid fits flush against trailer wall
- Secure-locking mechanism
- Lid available in brite aluminum or Armor-X Coating finish
- Aerodynamic-domed lid adds strength, reduces drag
- Easy access with self-rising lid
- Strong, lockable paddle handle

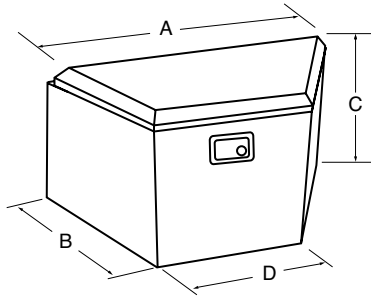

MODEL	DESCRIPTION	STYLE	CUBIC FT	SIZE	DIMENSIONS IN INCHES			
					A	B	C	D
6220RH	16" Trailer Tongue Box	Black	4.00	Small	34.00	21.00	18.00	16.00
6221RH	16" Trailer Tongue Box	Black/Brite	4.00	Small	34.00	21.00	18.00	16.00
6234RH	21" Trailer Tongue Box	Black	4.10	Medium	34.00	16.00	22.50	21.00
6235RH	21" Trailer Tongue Box	Black/Brite	4.10	Medium	34.00	16.00	22.50	21.00

### Armor-X Coating: Liquid Storage Tanks

Tanks are available in rectangular and L-shaped configurations to meet a variety of applications.

- L-shaped tanks accommodate full-size, flush-mount chests, cross bed boxes and saddle boxes
- Base mounting tabs for secure, easy installation
- Baffles provide an even flow of liquid
- Lockable vent caps to prevent tampering

**NOTE:**

- Not intended for transferring gasoline or other flammables, and should not be used as an auxiliary fuel tank
- Does not meet DOT specifications

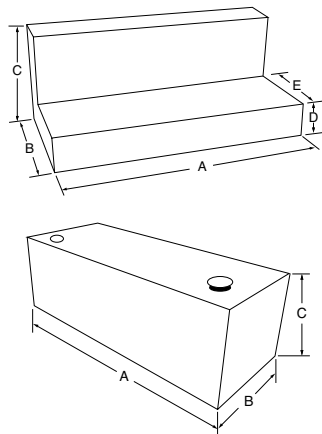

MODEL	DESCRIPTION	STYLE	SIZE	DIMENSIONS IN INCHES				
				A	B	C	D	E
3292RH	92 Gallon L-Shaped Tank	Black	54.00	31.00	25.00	8.50	20.50	20.50
3198RH	98 Gallon Rectangular Tank	Black	54.00	22.05	19.25	-	-	-

### Armor-X Coating: Job Site Box

LUND Job Site Boxes are packed with features to last a lifetime.

- 16-gauge steel
- Self-enclosed hinge systems prevent tampering
- Recessed padlock inlets
- Fold-down, recessed side handles
- Protected with Armor-X Coating
- Sturdy, one-piece, no sag base design

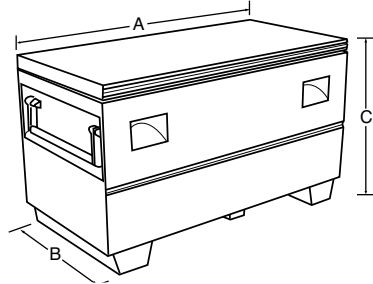

MODEL	DESCRIPTION	STYLE	CUBIC FT	SIZE	DIMENSIONS IN INCHES		
					A	B	C
6549RH	48" HD Medium Job Site Box	Black	4.70	Med	48.00	24.00	28.00

### Armor-X Coating: Underbody Boxes

Underbody boxes provide a secure, convenient storage solution.

- Weatherproof gasket prevents leakage
- Coated steel cable allows lid to remain open at a 90° angle
- Locking, stainless steel, flush mount T-handle provides security
- Lid available in brite aluminum or Armor-X Coating finish
- Sturdy, one-piece, no sag base design

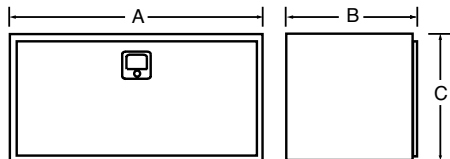

6236RH



6237RH

MODEL	DESCRIPTION	STYLE	CUBIC FT	SIZE	DIMENSIONS IN INCHES		
					A	B	C
6223RH	24" Underbody Box	Black	4.70	Compact	24.00	18.75	18.00
6224RH	24" Underbody Box	Black/Brite	4.70	Compact	24.00	18.75	18.00
6236RH	36" Underbody Box	Black	7.00	Med	36.00	18.75	18.00
6237RH	36" Underbody Box	Black/Brite	7.00	Med	36.00	18.75	18.00
6248RH	48" Underbody Box	Black	9.40	Med	48.00	18.75	18.00
6249RH	48" Underbody Box	Black/Brite	9.40	Med	48.00	18.75	18.00
6260RH	60" Underbody Box	Black	11.70	Large	60.00	18.75	18.00
6261RH	60" Underbody Box	Black/Brite	11.70	Large	60.00	18.75	18.00



## In Store Displays

- Increase product visibility
- Tradesman Truck Box program
- Displays assemble in minutes
- Potential double-digit sales lift

**Note:** Recommendations are based on distance between bed rails. Other factors may affect the suggested application, including location of wheel wells, fuel filler caps and bedliners. Measuring the vehicle is highly recommended to obtain the best fit.



RACK03T



RACK03